

Copyright Notice

PUBLISHED BY
Microsoft Corporation
One Microsoft Way
Redmond, Washington 98052-6399
Copyright © 1995 by Microsoft Corporation

All rights reserved. This document is provided for informational purposes only, and Microsoft Corporation makes no warranties, either express or implied, in this document. The entire risk of the use or the results of the use of this document remains with the user. Companies, names, and data used in examples herein are fictitious unless otherwise noted. No part of this document may be reproduced or transmitted in any form or by any means, electronic or mechanical, for any purpose, without the express written permission of Microsoft Corporation.

Microsoft, DoubleSpace, Microsoft Press, MS, MS-DOS, Win32, and Windows are registered trademarks, and DriveSpace, Microsoft At Work, Natural Keyboard, SQL Server, and Windows NT are trademarks of Microsoft Corporation in the USA and other countries. 3+Open, 3+Share, 3Com, EtherLink, and EtherLink II are registered trademarks, and EtherCard is a trademark of 3Com Corporation. Adaptec is a trademark of Adaptec, Inc. Adobe, Adobe Type Manager, Aldus, ATM, PageMaker, and PostScript are trademarks of Adobe Systems, Inc. AddStor is a registered trademark and SuperStor is a trademark of AddStor, Inc. AT&T is a registered trademark and Easylink is a service mark of American Telephone and Telegraph Company. Apple, AppleShare, AppleTalk, Macintosh, and TrueType are registered trademarks, and System 7 is a trademark of Apple Computer, Inc. Artisoft and LANtastic are registered trademarks of Artisoft, Inc. AST is a registered trademark of AST Research, Inc. Attachmate is a registered trademark of Attachmate Corporation. Banyan and VINES are registered trademarks, and StreetTalk is a trademark of Banyan Systems, Inc. Bitstream is a registered trademark and FaceLift is a trademark of Bitstream, Inc. Canon is a registered trademark of Canon USA, Inc. cc:Mail is a trademark of cc:Mail, Inc., a wholly owned subsidiary of Lotus Development Corporation. PC Tools is a trademark of Central Point Software, Inc. Centronics is a registered trademark of Centronics Data Computer Corp. Cheyenne is a registered trademark of Cheyenne Software, Inc. COMPAQ and Qvision are registered trademarks of Compaq Computer Corporation. CompuServe is a registered trademark and WinCIM is a service mark of CompuServe, Inc. Infonet is a registered trademark of Computer Sciences Corporation. Arcada is a registered trademark of Conner Peripherals, Inc. Sound Blaster is a trademark of Creative Technology, Ltd. Data General is a registered trademark of Data General Corporation. ArcNet is a registered trademark of Datapoint Corporation. Da Vinci Systems is a trademark of Da Vinci Systems Corporation. Dell is a registered trademark of Dell Computer Corporation. WinFax is a trademark of Delrina Technology, Inc. Crosstalk and DCA are trademarks of Digital Communications Associates, Inc. All-In-1, Alpha AXP, DEC, DECnet, Etherworks, PATHWORKS, Ultrix, VAX, VMS, and VT100 are trademarks of Digital Equipment Corporation. Truespeech is a trademark of DSP Group, Inc. Kodak is a registered trademark of Eastman Kodak Company. Fujitsu is a registered trademark of Fujitsu Limited. Future Domain is a registered trademark of Future Domain Corporation. GENie is a trademark of General Electric Corporation. Hayes is a registered trademark of Hayes Microcomputer Products, Inc. DeskJet, Hewlett-Packard, HP, HP-GL, HP-UX, JetDirect, LaserJet, and PCL are registered trademarks of Hewlett-Packard Company. Olivetti is a registered trademark of Ing. C. Olivetti. Intel and SatisFAXtion are registered trademarks, and EtherExpress, LANDesk, and Pentium are trademarks of Intel Corporation. AIX, AS/400, IBM, Micro Channel, NetView, OfficeVision, OS/2, PC/AT, PS/2, PROFS, ThinkPad, and XGA are registered trademarks, and OfficeVision/400, OfficeVision/MVS, PowerPC, and System/36 are trademarks of International Business Machines Corporation. Iomega is a registered trademark and Bernoulli Box is a trademark of Iomega Corporation. Toshiba is a registered trademark of Kabushiki Kaisha Toshiba. Logitech is a trademark of Logitech, Inc. Lotus and Lotus Notes are registered trademarks of Lotus Development Corporation. Panasonic is a registered trademark of Matsushita Electric Co., Ltd. MCI MAIL is a registered service mark of MCI Communications Corp. Media Vision is a trademark of Media Vision, Inc. Microcom is a registered trademark of Microcom Systems, Inc. MIPS is a registered trademark and R4000 is a trademark of MIPS Computer Systems, Inc. NCR is a registered trademark of NCR Corporation. NEC is a registered trademark of NEC Corporation. Btrieve, DR DOS, LAN Workplace, NetWare, and Novell are registered trademarks, and Novell DOS is a trademark of Novell, Inc. UNIX is a registered trademark of Novell, Inc. in the United States and other countries, licensed exclusively through X/Open, Ltd. Norton Utilities is a registered trademark of Peter

Norton Computing. Prodigy is a trademark of Prodigy Services Company. 386MAX is a registered trademark and BlueMAX is a trademark of Qualitas, Inc. America Online is a registered trademark of America Online, Inc. Retix is a registered trademark of Retix. SCSI is a registered trademark of Security Control Systems, Inc. Epson is a registered trademark of Seiko Epson Corporation, Inc. Shiva is a registered trademark of Shiva Microsystems Corporation. Silicon Graphics is a registered trademark of Silicon Graphics, Inc. WYSIfonts! is a registered trademark of SoftCraft, Inc. Soft-Switch is a trademark of Soft-Switch, Inc. SONY is a registered trademark of Sony Corporation. Stacker is a registered trademark of STAC Electronics. SMC is a registered trademark of Standard Microsystems Corporation. SpeedStor is a registered trademark of Storage Dimensions. PC-NFS, Sun, and Sun Microsystems are registered trademarks, and SunSoft is a trademark of Sun Microsystems, Incorporated. Tandy is a registered trademark of Tandy Corporation. Arial and Times New Roman are registered trademarks of The Monotype Corporation. Unisys is a registered trademark of Unisys Corporation. Rumba is a registered trademark and Wall Data is a trademark of Wall Data Incorporated. WANG is a registered trademark of Wang Laboratories. Western Digital is a trademark of Western Digital Corporation.

Eastman Kodak is the supplier of the default color matching method, known as Image Color Matching (ICM), in Windows 95. (For more information about Eastman Kodak products, see Appendix J, "Windows 95 Resource Directory.")

Jointly developed by Microsoft and Systems Compatibility Corporation (SCC), Quick Viewers for popular file formats are included in Windows 95. (SCC offers additional viewers and features in its Outside In for Windows product.)

U.S. Patent No. 4955066

Welcome to Windows 95

Introduction

The Microsoft® Windows® 95 operating system is the newest version of the Microsoft Windows operating system. It is the successor to MS-DOS®, Windows version 3.1, and Windows for Workgroups version 3.x.

Windows 95 was designed to provide network administrators and systems-support professionals with a variety of powerful tools and capabilities to better manage personal computers and reduce company support costs. In addition, Windows 95 offers new features and an improved user interface to help users be more productive.

This *Windows 95 Resource Kit*, written for administrators and MIS professionals, provides the information required for rolling out, supporting, and understanding Windows 95. This Resource Kit is a technical resource that supplements the documentation included with the Windows 95 product. For information about how to use Windows 95 features and utilities, see the product documentation and online Help information supplied with Windows 95.

How to Use the Windows 95 Resource Kit

This chapter describes the contents of the Resource Kit and lists conventions used throughout the document. The Guided Tour for Administrators, which follows, explores the benefits of implementing Windows 95 on corporate networks including cost reduction, system management, and user productivity. The remainder of the kit describes major topics related to installing and implementing Windows 95:

Part 1, Deployment Planning Guide.

Provides an overview for MIS managers and technical support personnel of the process for testing and deploying Windows 95 on the corporate network, plus details about how to make decisions and how to plan, test, and prepare for a major rollout of Windows 95.

Note Be sure to read [Deployment Planning Basics](#) and [Deployment Strategy and Details](#) before attempting to deploy Windows 95 in your organization. These chapters provide essential information for developing, testing, and carrying out a deployment plan that will result in a successful company-wide installation of Windows 95.

Part 2, Installation.

Presents technical details for installing Windows 95 on multiple computers, including information about creating custom installations and installing Windows 95 from setup scripts. This part also presents technical details about internal processes for Windows 95 Setup and operating system startup.

Part 3, Networking.

Describes how to install and configure Windows 95 on different kinds of networks (such as Windows NT™ and Novell® NetWare®) plus information about installing Windows 95 to run with a real-mode network client from other network vendors. This part also presents technical details about configuring peer resource sharing services with Windows 95, plus details about configuring network adapters and protocols.

Part 4, System Management.

Describes the system-management features provided with Windows 95, including system policies, management tools, and remote administration capabilities. This part also describes how to take advantage of user profiles, and how to install and use various agent software provided for backup and other system-management tasks. Finally, this part also discusses how to monitor and change parameters affecting Windows 95 performance.

Part 5, System Configuration.

Describes how to install and troubleshoot devices, configure and run applications, and set up and manage printers.

Part 6, Communications.

Provides details about the built-in communications features in Windows 95, including configuring and using modems and related software, and setting up and using Microsoft Exchange and Microsoft Fax. This part also includes information about Dial-Up Networking (also known as remote network access), The Microsoft Network online service, and Internet access.

Part 7, Windows 95 Reference.

Provides technical details about the Windows 95 architecture and the Registry (which stores system configuration, networking, and software settings). This part also summarizes the Windows 95 features that make it easy to use among multiple languages and locales. Finally, this part provides a summary of how to troubleshoot problems in Windows 95 and how you can use the built-in tools to solve problems.

Part 8, Appendixes.

Provides a summary of commands that can be used at the command prompt or in batch files. In addition, separate appendixes provide supporting details for creating custom setup scripts, configuring the network, using shortcuts and accessibility features, and finding more information about Microsoft resources supporting Windows 95 users and software developers.

Each part begins with a brief table of contents that summarizes the chapters contained in that part. In

general, the first chapter is an introduction, providing background information related to the part topic and identifying the specific Windows 95 features or capabilities discussed in the remaining chapters. Each of the remaining chapters discusses benefits of a particular feature or functionality, covers implementation issues, and provides specific procedures that will help administrators take advantage of that feature or functionality.

Welcome to Windows 95

Windows 95 Resource Kit Utilities

In addition to the printed book, the *Windows 95 Resource Kit* provides disks containing utilities for use with Windows 95. For a list of the available tools and information about how to use them, see the online Help and README files provided.

Microsoft also provides Windows 95 utilities in these other ways:

- Microsoft Plus! for Windows 95. This product contains advanced utilities for drive compression and maintenance, in addition to new font features, animated cursors, and a dial-up networking server.
- The Microsoft Network and other online services. For information about what's available from Microsoft using online sources, see [The Microsoft Network](#) and [Windows 95 Resource Directory](#).

Conventions

The following conventional terms, text formats, and symbols are used throughout the printed documentation for Windows 95.

Convention	Meaning
[brackets]	In syntax statements, indicates an optional item. For example, <i>[password]</i> indicates that you can choose to type a password with the command. Type only the information within the brackets, not the brackets themselves.
... (ellipsis)	In syntax statements, indicates that you can repeat the previous items. For example, <i>/route:devicename[,...]</i> indicates that you can specify more than one device, separating each device with a comma.
	Stands for "or" and separates items within braces or brackets. For example, <i>{/hold /release /delete}</i> indicates that you must type <i>/hold</i> or <i>/release</i> or <i>/delete</i> .
%...%	Used at the beginning and at the end of an item to indicate that it is a string identifier.
Bold	Indicates the actual commands, words, or characters that you type in a dialog box or at the command prompt.
<i>Italic</i>	Indicates a placeholder for information or parameters that you must provide. For example, if the procedure asks you to type <i>filename</i> , you must type the actual name of a file.
ALL UPPERCASE	Indicates a directory, filename, or acronym. You can use lowercase letters when you type directory names or filenames in a dialog box or at the command prompt, unless otherwise indicated for a specific application or utility.
Monospace	Represents examples of screen text or entries that you might type at the command line or in initialization files.
right-click	Refers to clicking the secondary mouse button, which is usually the right mouse button.
Windows NT	Refers to operating system and networking functionality that is available in the Windows NT operating system.
Windows directory	Refers to the Windows 95 system directory tree. This can be C:\WINDOWS or whatever other directory name you specified when installing Windows 95.
x86	Refers to computers based on 32-bit, x86-based microprocessors (such as Intel® 80386 or higher) or based on Intel Pentium™ microprocessors.

The following are standard abbreviations or acronyms used throughout this Resource Kit, with their meanings.

Acronym	Meaning
API	Application programming interface
BIOS	Basic input/output system
CPU	Central processing unit
DLL	Dynamic-link library
DMA	Direct memory access
FAT	File allocation table

GB	Gigabyte or gigabytes
HPFS	The file system provided with OS/2
I/O	Input/output
IHV	Independent hardware vendor
IRQ	Interrupt request lines
ISV	Independent software vendor
K	Kilobyte or kilobytes
LAN	Local area network
MB	Megabyte or megabytes
MIS	Management information system
OEM	Original equipment manufacturer
SMB	Server message block
TSR	Terminate-and-stay-resident
UNC	Universal naming convention
VM	Virtual machine
WAN	Wide area network

Deployment Planning Guide

This part of the *Windows 95 Resource Kit* provides network administrators and systems-support professionals with a comprehensive guide to installing and deploying (or rolling out) Microsoft Windows 95 in corporations. In this guide, based on interviews with administrators of corporate networks about their testing and rollout plans for Windows 95, you can find important information about how to develop and implement a plan for company-wide deployment of Windows 95.

Chapter 1 Deployment Planning Basics

Provides an overview of major deployment steps and a timeline for the deployment process.

Chapter 2 Deployment Strategy and Details

Provides detailed explanations of steps in the deployment process and the key decisions or actions related to performing them.

A Microsoft Project (.MPP) file is available with the *Windows 95 Resource Kit* utilities to use as a template for the overview and details of deployment planning described in [Deployment Planning Basics](#) and [Deployment Strategy and Details](#).

Notice that these chapters serve as a guide for creating and carrying out a rollout plan in an organization. Your company's specific rollout plan may be different, due to existing policies and processes.

Introduction

This chapter is for administrators who are responsible for corporate implementation of Windows 95. It provides an overview of the major steps in the deployment process. [Deployment Strategy and Details](#), contains the details about how to make decisions and perform actions listed in the overview.

Notice that some tasks may not be necessary for your organization.

For step-by-step instructions on conducting the installation, see [Introduction to Windows 95 Setup and Custom, Automated, and Push Installations](#), in the *Windows 95 Resource Kit*.

- [Overview of the Deployment Process](#)
- [Reviewing Windows 95 Features: An Overview](#)
- [Preparing the Teams: An Overview](#)
- [Deciding on the Preferred Client Configuration: An Overview](#)
- [Performing the Lab Test: An Overview](#)
- [Planning the Pilot Rollout: An Overview](#)
- [Conducting the Pilot Rollout: An Overview](#)
- [Finalizing the Rollout Plan: An Overview](#)
- [Rolling Out Windows 95: An Overview](#)

Overview of the Deployment Process

The deployment process for Windows 95 consists of several distinct phases, including the following:

- Reviewing Windows 95
- Preparing the Planning and Support teams
- Identifying the preferred network-client configuration
- Performing lab tests of the client configuration
- Planning the pilot rollout
- Conducting the pilot rollout
- Finalizing the rollout plan
- Rolling out Windows 95

For each phase, this chapter contains a section outlining in checklist form the required tasks for that deployment phase. [Deployment Strategy and Details](#) provides details for performing each task according to the deployment phase.

The *Windows 95 Resource Kit* utilities include document templates containing the deployment checklist plus a Microsoft Project file for planning the deployment process at your site.

The following sample shows how to read a deployment checklist for any phase.

Description of the Deployment Phase

Task	Team	Start week	Duration
1: Summary of the task.	Who will perform this task?	When does the team begin this task?	How long will it take to complete?

The following teams, made up of employees from your organization, are responsible for performing the tasks described in deployment checklists:

- The Executive team includes the deployment project manager (usually the head of the Information Systems department) and members of the executive committee of the corporation. This team must include one or more individuals with decision-making authority over company policies and procedures.
- The Planning team includes the deployment project manager, key Installation team members, and a representative from the Support and Training teams.
- The Installation team includes technicians and individuals who will be conducting the installation. This team must include a specialist in 32-bit applications who can evaluate the proposed Windows 95 configuration for compatibility.
- The Support team includes staff of the help desk or Support department, and select individuals from the Planning team. This team develops a plan for supporting Windows 95 during and after deployment, integrating new methods and processes as needed into the existing support scheme.
- The Training team includes individuals responsible for user training.

At certain phases, you may choose to vary the makeup of the teams by adding or omitting individuals.

Reviewing Windows 95 Features: An Overview

When implemented, Windows 95 can yield significant benefits to your organization in terms of reduced costs and increased system control. Because many decisions — starting with the decision to acquire Windows 95 — depend on these and other anticipated benefits, becoming familiar with the features and benefits of Windows 95 is the first step in deployment planning.

The following checklist lists sources of information on Windows 95 features and benefits.

Reviewing Windows 95 Features

Task	Team	Start week	Duration
1: Read <i>Introducing Microsoft Windows 95</i> , available from Microsoft Press (ISBN 1-55615-860-2) or the <i>Windows 95 Reviewer's Guide</i> (available from WinNews forums on the Internet and other online services).	Executive, Planning	Week 1	7 days
2: Review total cost of ownership, migration, and productivity studies published by analysts such as Gartner Group, Inc. if appropriate. Use these studies to assess the impact of Windows 95 on your business's bottom line.	Executive, Planning	Week 1	14 days
3: Acquire additional copies of the <i>Windows 95 Resource Kit</i> for review during the deployment process.	Planning	Week 2	1 day

Preparing the Teams: An Overview

After the review of Windows 95 features and benefits, the next step is to prepare the Planning, Installation, and Support teams for the deployment process. If you did not fully staff the Planning team for the review phase, assemble the people you need for both the Planning and Installation teams at this time. Then gather the equipment and tools to be used in planning the Windows 95 implementation and arrange for Support team training. The following checklist outlines the processes of assembling the Planning and Installation teams and its resources and coordinating Support team training.

Preparing the Teams

Task	Team	Start week	Duration
1: Assign the project manager, if appropriate (usually this is the head of the Information Systems department).	Planning	Week 2	—
2: Select key Planning and Installation team members, if appropriate. Make sure to include an applications specialist, for evaluating 32-bit applications.	Planning, Installation	Week 2	5 days
3: Acquire Windows 95 (the compact disc version is preferred because it contains system administration tools).	Planning	Week 2	1 day
4: Identify your client and server hardware and software configurations on the network.	Planning	Week 3	5 days
5: Set up a testing lab.	Planning	Week 2	1 day
6: Acquire test computers for use as the network server and clients. Choose computer models that are typical of those used in your organization.	Planning	Week 2	5 days
7: Install the applications software and line-of-business tools in the lab to simulate the network environment. Also identify the mission-critical and noncritical business and other applications typically used in your organization. Create a checklist for evaluating the compatibility and performance of these applications during testing.	Planning	Week 3	3 days
8: Review detailed discussions of product features in the “Guided Tour for Administrators” in the <i>Windows 95 Resource Kit</i> ; study Installation , of the Resource Kit to prepare for configuration planning.	Planning, Installation	Week 3	3 days
9: Study the entire <i>Windows 95</i>	Support	Week 3	10 days

Resource Kit. As an option, obtain Windows 95 TrainCast instructional videotapes from Microsoft. As another option, arrange for the team and other individuals, as appropriate, to attend training at a Microsoft Authorized Technical Education Center and participate in the Microsoft Certified Professional program to prepare for supporting Windows 95.

10: As an option, read <i>Inside Windows 95</i> from Microsoft Press, for technical details on the internal operation of Windows 95.	Planning, Installation, Support	Week 2	10 days
---	---------------------------------	--------	---------

Deciding on the Preferred Client Configuration: An Overview

With the Planning and Installation teams assembled and educated about Windows 95 capabilities, the next task for these teams is to determine the preferred configuration for client computers on the network. (For the purposes of this discussion, “client computer” refers to any computer running Windows 95, including computers that act as peer servers by running File and Printer Sharing services.) The teams will use this configuration for evaluation and testing, prior to full implementation of Windows 95 in your organization.

The tables in this section summarize options to consider in planning your preferred configuration. Using the information in these tables, evaluate the available features and the related alternatives before making a decision. Microsoft recommends that you begin your evaluation with the “ideal” configuration, that is, a configuration that uses all of the most powerful features of Windows 95. Then gradually modify this configuration, adding or removing features, until you achieve a configuration that more closely fits your company’s needs. When you have identified the preferred configuration, document the configuration layout and the selected features to make sure you install and test the correct configuration.

To learn more about product features as they relate to your system configuration, see [Deployment Strategy and Details](#), or the related chapters of the Resource Kit.

The following table presents an overview of configuration layout decisions and feature options for the ideal network client. An additional table lists features which Microsoft recommends for implementation by all organizations; these features define how Windows 95 will be installed and administered in your organization. The final table shows optional features that may be useful in some organizations.

Configuration Layout Decisions

Configuration option	Decisions and issues
Location of Windows files <i>To maximize performance, security, or hard disk space on the client computer</i>	Depends on your need to maximize central security and administration versus performance on the client computer. Also depends on the hardware platform of the client computer. Options: <ul style="list-style-type: none">• Run Windows 95 on the client computer for best performance and reduced network traffic.• Run Windows 95 from the server to save hard disk space on client computers and make it easier to upgrade components or drivers later, especially for multiple computers.• Run completely from the server for the highest degree of security or for diskless workstations. For information, see Server-Based Setup for Windows 95 .

Key Features of the Ideal Network Client

Preferred feature	Decisions and issues
Use 32-bit, protected-mode network client software <i>To provide the best network performance and functionality</i>	Depends on the compatibility of your required applications. Options vary based on your network. For example, for Novell® NetWare® networks: <ul style="list-style-type: none">• Protected-mode Client for NetWare Networks is the preferred client, because of the performance and increased functionality, and because it’s easy to install and configure.

- Real-mode Novell NETX or VLM clients may offer slightly better compatibility with some network utilities.
- A real-mode network client for another network can also be used with Client for NetWare Networks.

For information, see [Networking](#).

Use 32-bit, protected-mode protocols

To provide the best network performance and functionality

Depends on compatibility with your choice of client. Options depend on your choice of protocol. For example, for IPX/SPX:

- Microsoft IPX/SPX-compatible protocol is preferred (with or without IPX over NetBIOS).
- Keep real-mode IPXODI for use with a real-mode Novell-supplied client.
- Both the real-mode and Microsoft protected-mode implementations can be used if some of your applications (such as TSRs) require the real-mode protocol.

For information, see [Network Technical Discussion](#).

Use the latest network adapter drivers

To provide improved performance and the ability to both load and unload the network and notify the rest of the system, use NDIS 3.1 drivers, which support Plug and Play

Depends on the availability and compatibility of the new driver. The 32-bit, protected mode drivers offer vastly improved performance and reliability over older versions. For PCMCIA cards, the 32-bit drivers are extremely easy to manage.

Options:

- Always use the newest drivers available; implemented by default.
- Manually choose to keep using an older driver, including ODI drivers, if new drivers are not available.

For information, see [Network Technical Discussion](#).

Use the new Windows 95 user interface

To provide ease of use and maximum functionality in accessing Windows 95 features

Depends on timing or preference rather than functionality because the new user interface is significantly more functional and efficient. But, if a rapid migration is required, and training is not immediately available, the Windows 3.1 user interface can be used temporarily.

Options:

- Use the new user interface; this is preferred and installed by default.
- Install the Windows 3.x File Manager and Program Manager.

For information, see [Application Support](#).

Recommended Windows 95 Features for Client Configurations

Windows 95 feature

Use system policies

To enable centralized

Decisions and issues

Choose this feature to enable centralized administration or add control.

administration capabilities of Windows 95 or add control of the user's desktop

Options:

- Use System Policy Editor to define policies at any time.
- For computers running a shared copy of Windows 95 from a server, configure the shared installation directory with a limited set of components for Windows 95. This is not a recommended choice.

For information, see [User Profiles and System Policies](#).

Use user profiles

To allow multiple users to use a single computer with their own settings or, conversely, to allow personalized settings per user on multiple computers

Choose this feature to maintain consistent desktop and environment settings on a user-specific basis. Enabling user profiles causes a slight delay during logon.

Options:

- Users can control changes to their user profiles and update them as they want.
- Administrators can predefine a mandatory profile for specific users, that can only be changed by the administrator.

For information, see [User Profiles and System Policies](#).

Enable remote administration

To allow an administrator to remotely manage the file system, network sharing, or Registry of the individual computers

Install this service to allow remote administration. To use it, you must use a 32-bit network client and also enable user-level access.

For information, see [Remote Administration](#).

Use setup scripts (batch files) for installation

To allow automated installation on client computers

Choose this feature if you must install Windows 95 on more than five computers.

Server-based Setup offers an easy to use, graphical tool for creating setup scripts. You can also manually create a script with additional options by creating a text file with the appropriate entries.

For information, see [Custom, Automated, and Push Installations](#), and [MSBATCH.INF Parameters](#).

Set up for push installation

To allow the administrator to push the installation from the server without touching the client computer

Choose to use a push installation, based on the location and number of computers you must upgrade.

Options:

- Edit the login script to run a setup script.
- Use a tool such as the Microsoft Systems Management Server to facilitate the setup.

For information, see [Custom, Automated, and Push Installations](#), and [Microsoft Systems Management Server](#).

Use peer resource

Choose this feature based on your site's security

sharing services

To allow a client computer to share files and resources such as printers and CD-ROM drives with other computers

needs. If users are allowed to share local resources on their computers, then peer resource sharing can save network traffic and hard disk space on the server. For central control or to prevent users from turning on this feature, use system policies.

This feature can only be installed on computers that use a 32-bit, protected-mode network client.

For information, see [Logon, Browsing, and Resource Sharing](#).

Use user-level security

To implement control for a variety of services beyond network resource access, including File and Printer Sharing, Remote Registry, backup agents, and other network and system management functions

Choose this feature to enable users to specify the users and groups who have access to local shared resources (including the Registry). Validation by a Windows NT Server or a NetWare server can also be required before access to any resources is possible under Windows 95.

Options:

- Users can specify access rights for individuals and groups to shared resources.
- User access is validated based on user accounts on a Windows NT domain or a Novell NetWare bindery.
- User-level security is required for remote administration of the Registry and for network access to full user profiles.
- Optionally, share-level security can be used to protect files on Windows NT networks or Windows 95 peer networks.

For information, see [Security](#).

Other Optional Windows 95 Features

Windows 95 feature

Use Microsoft Exchange Mail

To have a unified inbox for messages, faxes, and so on

Decisions and issues

Depends on whether you have an existing mail system and whether you want the added integration of messaging services offered by Microsoft Exchange.

Options:

- Install all or part of Microsoft Exchange during the installation.
- Run your existing mail client as usual.

For information, see [Electronic Mail and Microsoft Exchange](#).

Use Windows 95 mobile computing features

To enable Windows 95 features that support mobile computing or switching between portable and docking-station configurations

Depends on the particular hardware and the working needs of mobile-computing users. Some of these features are not installed by default but can be specified during Setup or installed later:

- Dial-Up Networking client software for dial-up connection to popular servers
- Windows 95 Briefcase for synchronizing files between computers, and Direct Cable

Connection for directly linking two computers, plus other built-in communications applications

- Remote mail and deferred printing, for working away from the main office
- Automatic configuration for PCMCIA cards, and for all components with Plug and Play-compliant hardware
- User profiles to provide a custom desktop for each user, no matter where users log on to the network

For information, see [Devices](#), and [Dial-Up Networking and Mobile Computing](#).

Use other Windows 95 value-added features

To enable other Windows 95 ease-of-use innovations and capabilities such as The Microsoft Network and Microsoft Fax

Depends on your existing services and needs. In general, if client computers have the hard disk space and use a utility or an application with the same capabilities from another vendor, you should install the new features and test their value.

These features are not installed by default but can be specified during Setup or installed later:

- Microsoft Fax for fax receipt and transmission
- The Microsoft Network for online services

For information, see [Electronic Mail and Microsoft Exchange](#), [Microsoft Fax](#), and [The Microsoft Network](#).

Performing the Lab Test: An Overview

Using the preferred client configuration specified in the previous phase, proceed with installing the configuration in the lab for testing and evaluation. Because only the client-computer configuration is being installed (server installation is described in the following section), this test only determines whether the preferred configuration performs as expected, and whether it is compatible with your current applications and processes.

Depending on how the test installation proceeds, it may be necessary to modify the configuration, by either adding or removing selected features. If more than one configuration is being considered, side-by-side evaluations of different configurations can be performed to help determine which one works best.

The following checklist outlines the tasks in performing the lab test of the client configuration. These tasks apply for each computer used to install a client configuration. For step-by-step instructions on installing and selecting features, see [Introduction to Windows 95 Setup](#).

Performing the Lab Test

Task	Team	Start week	Duration
1: Make sure that the computer meets your company's standards and the Windows 95 minimum standards for operation — at least a 4-MB 386DX or better. If not, perform the hardware upgrades now.	Installation	Week 4	0.1 day
2: Defragment the hard disk and scan it for viruses.	Installation	Week 4	0.1 day
3: Back up and verify key data and configuration files, such as INI, AUTOEXEC.BAT, and CONFIG.SYS files. Also back up the Windows and DOS directories, and all files in the root directory. Make a system startup disk containing COMMAND.COM, SYS.COM, and FDISK.EXE.	Installation	Week 4	0.1 day
4: Make sure that the current network client software is functioning properly and, referring to the checklist of inventoried applications, make sure that all important applications operate correctly.	Installation	Week 4	1 day
5: Install Windows 95 on the test computer in the lab, using the preferred client configuration identified in the previous phase.	Planning, Installation	Week 4	1 day
6: Test the installation: <ul style="list-style-type: none"> • Can you connect to and browse the network? • Can you print both locally and across the network? 	Planning, Installation	Week 4	2 days

- Can you perform the core operations of each application locally and on the network (including opening, closing, and printing)?

- Can you shut down successfully?

<p>7: Optionally, if you have several test computers, compare your old client configuration under Windows 3.x and your new preferred configuration. How do the two compare in terms of the following:</p>	<p>Installation, Planning</p>	<p>Week 5</p>	<p>2 days</p>
<ul style="list-style-type: none"> • Functionality for administering the computer? • Performance for local disk and network actions? • Ease of use for performing common tasks? • Stability of the computer under stress? • Compatibility with applications and hardware? 			
<p>8: If the specified client configuration did not work as expected, modify and document the differences until a working preferred client configuration is installed.</p>	<p>Planning, Installation</p>	<p>Week 5</p>	<p>As required</p>
<p>9: Perform a complete restoration of operating system files and system capabilities for your old client configuration on the computer running Windows 95.</p>	<p>Installation</p>	<p>Week 5</p>	<p>1 day</p>
<p>10: Evaluate the restoration process for problems. Document the process and the modifications made.</p>	<p>Installation, Planning</p>	<p>Week 5</p>	<p>0.5 day</p>
<p>11: Have all team members participate in installing the preferred configuration on a variety of hardware.</p>	<p>Installation, Planning</p>	<p>Week 5</p>	<p>3 days</p>

Planning the Pilot Rollout: An Overview

In this phase, appointed teams determine the best methods for automatically installing the specified configuration for a pilot or trial rollout. Planning for this pilot program involves creating the automated installation process, determining the logistics of testing, and preparing a training plan for users. The following checklist outlines the tasks in planning the pilot rollout.

Planning the Pilot Rollout

Task	Team	Start week	Duration
<p>1: Use Server-based Setup to install Windows 95 source files on a server. Make setup choices based on your client configuration, including whether you will run a shared copy of Windows 95 from the server, or run Windows 95 locally on the client computer. Perform the following steps:</p> <ul style="list-style-type: none"> • Set up the distribution server • Set up the client from the network <p>See Server-Based Setup for Windows 95, for step-by-step instructions. Document any changes to this process.</p>	Planning, Installation	Week 6	1 day
<p>2: Create and test an automated installation by creating a setup script to predefine settings for Setup. Document the key parts of the setup script that vary by installation.</p>	Planning, Installation	Week 6	2 days
<p>3: Determine and test how you will push the installation from the server without having to touch the client computers. (See Custom, Automated, and Push Installations) Options:</p> <ul style="list-style-type: none"> • Modify login scripts on the server. • Use management software such as Microsoft Systems Management Server. • Send a setup script (batch file) that runs Windows 95 Setup as an embedded link in an electronic mail message. <p>Document the process for the rest of the Installation team.</p>	Planning, Installation	Week 6	3 days

Planning the Pilot Rollout (continued)

Task	Team	Start week	Duration
4: Evaluate the Windows 95	Planning,	Week 7	2 days

<p>installation process for opportunities to upgrade or improve your organization's existing technology infrastructure. For example, a system management software tool can help you administer computers on the network more easily, and it can help with the push installation process.</p>	Executive			
<p>5: Document in checklist form the logistics of the pilot installation, such as the total time for installation, the new software or tools to be purchased, the group selected as the pilot users, and the scheduling of specific installations. Use this prior to the rollout to make sure you are completely prepared.</p>	Installation, Planning	Week 7	3 days	
<p>Also, document goals for the pilot rollout to be used as evaluation criteria for rating the success of the rollout.</p>				
<p>6: Send a memo to your users to clearly explain how the installation process will affect their daily work schedule and describe the differences they will see after the installation is completed.</p>	Planning	Week 7	1 day	
<p>7: Develop a user training course (or hire a training vendor to prepare one). Use the Windows 95 Help and <i>Introducing Microsoft Windows 95</i> (supplied with the Windows 95 distribution disks) to "jump start" your training efforts.</p>	Planning, Support, Training	Week 6	5 days	
<p>8: Establish a support plan for the pilot user group. This includes the names and phone numbers of persons to contact for assistance, a short list of the top questions and answers, and troubleshooting tips.</p>	Planning, Support	Week 7	5 days	
<p>9: Set up the lab or classroom with computers for training.</p>	Training	Week 7	2 days	
<p>10: Edit the Windows 95 Help file (if appropriate) to include any company-specific information. Repeat this after the pilot rollout is completed.</p>	Planning, Support	Week 8	4 days	

Conducting the Pilot Rollout: An Overview

The goal of the pilot program is to test your automated installation in everyday use among a limited group of users (for example, between 15 and 50). This process helps to identify problems that may impede or delay the deployment process, and helps to determine what resources you'll require for the final, company-wide rollout. It's important to make the pilot rollout as successful as possible because it sets the tone for the rest of the deployment process. If pilot users are satisfied, their enthusiasm can influence others to cooperate, which in turn helps the rest of the process to move smoothly.

The following checklist outlines the tasks in conducting the pilot rollout. Use the same pilot user group and follow the same tasks when rolling out 32-bit applications.

Conducting the Pilot Rollout

Task	Team	Start week	Duration
1: Select a pilot user group that is willing and able (particularly in terms of their workload) to handle the installation process.	Planning	Week 8	2 days
2: Train the users.	Training	Week 8	5 days
3: Back up the Windows and DOS directories and the files on the root directory of the test computers.	Installation	Week 9	5 days
4: Following the logistics checklist prepared in the previous phase, perform the installation in the same manner that you expect to install Windows 95 throughout the company. Compare your results against goals and evaluation criteria (developed in the previous task) for this process.	Installation	Week 9	10 days
5: Have your technicians on-site for the initial installations to document the process and problems and to support the users. Have other technicians monitor time and all measurable factors in the installation process. Record these measurements for later evaluation.	Support	Week 9	15 days
6: Make sure that all computers are "up and running" as expected. Make note of possible improvements to the installation, training, or support, where appropriate.	Planning, Installation, Support	Week 11	3 days
7: Survey members of the pilot user group about their satisfaction with the installation process and take feedback on	Planning	Week 12	3 days

what could have been done better.

- | | | | |
|---|------------------------|---------|---|
| 8: Continue to monitor the pilot installation for a week to make sure that everything continues to run smoothly. | Support, Planning | Week 11 | 5 days |
| 9: Prepare a checklist of issues to resolve for the final rollout. Include in this checklist the areas identified in step 6 as needing improvement, comments from the user survey, and the results of comparing your rollout goals and evaluation criteria against actual performance. | Support, Planning | Week 11 | 5 days |
| 10: If the pilot program did not run smoothly or user feedback was poor, conduct additional pilot installations until the process works well. | Planning, Installation | Week 12 | See "Planning the Pilot Rollout: An Overview" |

Finalizing the Rollout Plan: An Overview

The results of the pilot installation provide the basis for developing a final plan for rollout. Using the actual time and resource requirements from the smaller-scale pilot rollout, teams make projections for time and resources, corresponding to the company-wide scope of the final rollout. If additional resources are required, identify these and acquire them at this time. In addition, update company policies and standards regarding computer and network use to accommodate the Windows 95 implementation.

Finalize the Rollout Plan

Task	Team	Start week	Duration
1: Determine your rollout goals — specifically the number of computers on which you will install Windows 95 and the time expected for completion. During preparation for final rollout, check off items on this list as they are resolved.	Planning, Executive	Week 12	5 days
2: Budget the resources, in terms of personnel and tools, required to meet your goals.	Planning	Week 12	3 days
3: If necessary, present the budget and obtain approval for the resources and the rollout process.	Executive, Planning	Week 13	2 days
4: Hire and train the extended Installation team and purchase the additional software or tools needed.	Training, Installation	Week 13	10 days
5: Update the company's hardware and software standards lists.	Planning	Week 13	2 days
6: Update the company's policies and practices manuals or guidelines for use of computers and the network.	Planning	Week 13	2 days
7: Notify your users that company standards and policies for computer use will be enforced prior to the installation and that they must bring their computers into compliance.	Planning	Week 13	1 day
8: If appropriate, edit the Windows 95 Help file to add company-specific Help for line-of-business applications.	Planning, Support	Week 14	3 days
9: For each computer, create a template as a database for documenting and tracking any system problems or deficiencies that require further attention.	Installation	Week 13	2 days
10: Post the updated template to a	Installation	Week 13	2 days

central network location.

Rolling Out Windows 95: An Overview

After the extensive research, planning, testing, and analysis performed in the previous phases, the deployment teams arrive at the final phase — rolling out the Windows 95 installation to the entire company. Although each prior phase was critical to the overall success of the deployment process, only this phase can fulfill the purpose of the entire planning process, by delivering the substantial new benefits of Windows 95 to your broadest base of users. At this phase, weeks of preparation pay off in a smooth migration of all your users to an operating system that is more powerful, more robust, and easier to use.

The following checklist outlines the tasks required for the final rollout of Windows 95.

Rolling Out Windows 95

Task	Team	Start week	Duration
1: Set up the distribution servers by using the Server-based Setup and configuring the system policy files.	Installation	Week 15	1 day
2: Customize the server installation by adding or removing the appropriate files, including the MSBATCH.INF file.	Installation	Week 15	2 days
3: Notify the users of the upcoming installation.	Planning	Week 15	1 day
4: Train the users on Windows 95.	Training	Week 16	As required
5: If needed, upgrade the hardware on the client computers and remove any software not complying with company policy.	Installation	Week 16	As required
6: If needed, back up critical data and configuration files on the client computers.	Installation	Week 16	As required
7: If needed, defragment the client hard disks.	Installation	Week 16	As required
8: Optionally, you can temporarily reset the user password and ID for each computer, to allow your technicians easy access to the client computer and make sure that the login scripts and environment operate correctly.	Planning	Week 17	As required
9: Make sure that the client computers are fully operational and the real-mode network, if present, is running.	Installation	Week 17	As required
10: Prepare the client computers for the push installation process: edit the login scripts; run the management software;	Installation	Week 18	As required

or send the setup script, by electronic mail, to the user.

- 11:** Initiate the installation by having the user log on, double-click the setup script file, and so on. Installation Week 18 As required

For details of each task in the deployment checklists, see [Deployment Strategy and Details](#). For step-by-step instructions on how to set up, maintain, and use Windows 95 in a corporate environment, see the appropriate chapters of the *Resource Kit*.

Introduction

This chapter contains details on the phases and tasks for rolling out Windows 95 that are summarized in [Deployment Planning Basics](#). If you are comfortable with the early planning phases of deployment, you can skip ahead to [Deciding on the Preferred Client Configuration: The Details](#).

Notice that some tasks may not be necessary for your organization.

- [Reviewing Windows 95 Features: The Details](#)
 - [Publications from Microsoft Press](#)
 - [Reports from Industry Experts](#)
- [Preparing the Teams: The Details](#)
 - [Acquiring Staff and Software](#)
 - [Conducting a Sample Inventory](#)
 - [Testing Lab Setup and Equipment](#)
 - [Training the Teams](#)
- [Deciding on the Preferred Client Configuration: The Details](#)
 - [Configuration Layout](#)
 - [Key Features of the Ideal Configuration](#)
 - [Recommended Features for Network Clients \(Optional\)](#)
 - [Other Optional Features](#)
- [Performing the Lab Test: The Details](#)
 - [Preparing the Test Site and Equipment](#)
 - [Installing Windows 95 on Test Computers](#)
 - [Testing the Installation](#)
 - [Testing the Restoration Process](#)
- [Planning the Pilot Rollout: The Details](#)
 - [Installing the Source Files for Setup](#)
 - [Automating the Installation](#)
 - [Documenting Rollout Logistics](#)
 - [Notifying Users of the Rollout](#)
 - [Developing User Training](#)
 - [Developing the Support Plan](#)
- [Conducting the Pilot Rollout: The Details](#)
 - [Simulating the Installation Process](#)
 - [Testing Windows 95 Performance and Capabilities](#)
 - [Surveying Users for Feedback](#)
- [Finalizing the Rollout Plan: The Details](#)
 - [Completing the Rollout Logistics and Budget](#)
 - [Updating the Policies and Practices Guidelines](#)
 - [Creating a Template for the Rollout Database](#)
- [Rolling Out Windows 95: The Details](#)

Deployment Strategy and Details

Reviewing Windows 95 Features: The Details

This is the first phase of the deployment process in which the Executive and Planning teams learn about Windows 95 features and benefits. In this phase, those responsible for planning and conducting the rollout learn how Windows 95 helps reduce support costs and increase business profitability. Publications are available from Microsoft Press and from independent industry analysts to provide the information you need.

Deployment Strategy and Details

Reviewing Windows 95 Features: The Details

Publications from Microsoft Press

The Executive and Planning teams need to acquire and review *Introducing Microsoft Windows 95* and the *Microsoft Windows 95 Resource Kit* during this phase:

Introducing Microsoft Windows 95 (ISBN 1-55615-860-2), available from Microsoft Press, provides information about Windows 95 features and functionality. This book discusses the changes and enhancements made to the Microsoft Windows operating system to provide easier management and support in a network environment. To order this or other Microsoft Press® titles, call (800) MSPRESS (or (800) 677-7377).

The information contained in *Introducing Microsoft Windows 95* is also available online as the *Windows 95 Reviewer's Guide*. For online access to the Reviewer's Guide or other current information on Windows 95, connect to the Microsoft WinNews forum at any of the following electronic locations.

Online service	How to access
-----------------------	----------------------

The Microsoft Network	From the Windows 95 desktop, click the icon for The Microsoft Network. Then click Microsoft and, in the Microsoft menu, select Windows 95. Click WinNews.
-----------------------	---

America Online®	Use the keyword winnews
-----------------	--------------------------------

CompuServe®	Type go winnews
-------------	------------------------

FTP on the Internet	Type ftp://ftp.microsoft.com/PerOpSys/Win_News
---------------------	---

GEnie™	Download files from the WinNews area under the Windows 95 RTC.
--------	--

Prodigy™	Type jump winnews
----------	--------------------------

World Wide Web on the Internet	Type http://www.microsoft.com
--------------------------------	--------------------------------------

The *Windows 95 Resource Kit* is important equipment for your deployment teams. Written to assist administrators in installing, supporting, and managing Windows 95 on corporate networks, the Resource Kit is a technical supplement to the Windows 95 product documentation. Each Planning and Installation team member should obtain a copy of the Resource Kit for review as they prepare for deployment planning.

Deployment Strategy and Details

Reviewing Windows 95 Features: The Details

Reports from Industry Experts

Many leading industry analysts have developed independent assessments of the impact of Windows 95 on corporate operations. The reports of two firms, Gartner Group, Inc. and Usability Sciences Corporation, discussed in this section, can assist rollout planners in understanding specifically how Windows 95 reduces the total cost of ownership for a personal computer in your organization.

Deployment Strategy and Details

Reviewing Windows 95 Features: The Details

Reports from Industry Experts

Gartner Group, Inc. Reports

Two published reports are available that describe the cost of migrating to Windows 95 from Windows 3.x and the effect of Windows 95 on the total cost of ownership of a personal computer. This section summarizes key findings of the reports. To receive the complete report, contact Gartner Group, Inc. at (203) 967-6700 and ask for the Total Cost of Ownership study (reference Personal Computing Service K-820-1094) and the report titled "GUI Operating System Migration: How Sticky Will It Be?" (August 22, 1994).

Highlights of these reports include the following.

Payback period is short.

Gartner Group projects that a typical organization will earn back the cost of migrating to Windows 95 within three to six months, based on support cost savings alone. Assuming that, on an annual basis, Windows 95 costs \$1180 less per user to run than Windows 3.1, over five years, Gartner Group estimates that organizations will save nearly \$6000 per user. Notice that, even if organizations do not realize this precise reduction in costs, the support-cost savings should substantially exceed the cost of migration.

Migration is justified even when only using 16-bit applications.

Gartner Group recommends that organizations migrate to Windows 95 "if only to run 16-bit Windows applications on a more stable, easier to use platform."

Planning Windows 95 deployment increases potential savings.

In its "Cost of Migration" study, Gartner Group demonstrates that organizations benefit substantially through decreased costs by planning their deployment of Windows 95. In fact, by planning the traditional labor-intensive operations (for example, the installation process) and automating the process, an organization could realize costs of migrating to Windows 95 that are less than the average upgrade cost from Windows 3.0 to Windows 3.1.

Although not cited in these reports, additional payback should result from increased user productivity due to features such as Dial-Up Networking, multitasking, multithreading, and so on.

Deployment Strategy and Details

Reviewing Windows 95 Features: The Details

Reports from Industry Experts

Usability Sciences Corporation Report

Usability Sciences Corporation, an independent usability testing group, performed a study on how users are affected by moving to Windows 95. Their study included 75 existing Windows 3.1 users with varied levels of skill in performing common tasks. Details of the study and its findings are available from the WinNews electronic forum.

Highlights of the study's results include the following.

Users get started quickly.

After testing users as they performed specified tasks in Windows 3.1, and then allowing them a 20-minute "play" period with Windows 95, the study found that the same users were almost as fast under Windows 95 in performing comparable tasks as they were in Windows 3.1.

Users perform faster.

Usability Sciences reported that, within 1.5 hours of first using Windows 95, users performed operations nearly twice as fast as they did on Windows 3.1.

Extensive user training is not needed.

Because all tests in the study were performed using the online Help that comes with Windows 95, the results demonstrate that lengthy training sessions are not necessary.

As additional reports and studies are published, they'll be placed on the WinNews online forums. Check these forums for periodic updates.

Deployment Strategy and Details

Preparing the Teams: The Details

This phase involves gathering the resources, including equipment, software, and staff, to properly plan for testing and evaluating Windows 95. Members of the Support team should receive training during this phase.

Deployment Strategy and Details

Preparing the Teams: The Details

Acquiring Staff and Software

The deployment project manager participates in the Executive team and leads the Planning team. This individual is usually the head of the Information Systems department; however, the executive committee may find another individual to be more appropriate, depending on the organization.

When setting up the Planning team, it is important to include a set of individuals representing the groups involved in the deployment process. This includes people from the Corporate Support and Employee Training departments, the Corporate Standards Committee, and key Installation team members. Individuals from the Finance and Accounting group will need to take part in planning and evaluation later on, but need not be assigned to the team for the full duration of the deployment process.

Your Installation team should include an applications expert, who can evaluate 32-bit applications run with Windows 95.

Obtain Windows 95 during this phase. Microsoft recommends that you purchase the compact-disc version, so that you can use Server-based Setup and administrative software tools not provided on the floppy disks.

Deployment Strategy and Details

Preparing the Teams: The Details

Conducting a Sample Inventory

You'll need to survey a representative sample of your network to identify the hardware and software typically used on client and server computers. By doing this sample inventory of your company's active equipment, you can accurately simulate the organizational environment in the lab. Such a simulation helps you make broad decisions about your company's computing infrastructure, such as the choice of protocol or the default desktop configuration as it pertains to applications.

Software management tools are available to query computers on the network for hardware and software configurations. For detailed information about a large number of computers on a network, use a system management program such as the Microsoft Systems Management Server to conduct the inventory.

Deployment Strategy and Details

Preparing the Teams: The Details

Testing Lab Setup and Equipment

To effectively evaluate and test the Windows 95 installation process, you need to set aside enough physical space and assemble a sufficient number of computers to test everything from Server-based Setup to hand-tuning options for the local computer. In addition, if your network environment includes the use of portable computers that dial in to the company, or if you use additional servers or mainframe computers for business data, you need to make sure that the lab computers have full access to the network and an analog phone line.

It is important that you test and implement all of the Windows 95 features comprehensively in the lab with all of your mission-critical and noncritical business applications before moving to the pilot installation.

Installation of Windows 95 on a server requires 90 MB of disk space.

Deployment Strategy and Details

Preparing the Teams: The Details

Training the Teams

By reviewing specific portions of the *Windows 95 Resource Kit*, the Installation and Planning teams can gain an extensive understanding of Windows 95 features and functionality. A review of the “Guided Tour for Administrators” and of the chapters contained in Installation, can provide the teams with the information necessary to evaluate product features for system configuration.

Support team members must become familiar with all information in the Resource Kit to prepare for their role in the deployment process. Windows 95 TrainCast instructional videotapes are also available from Microsoft (to obtain these, call (800) 597-3200). For more extensive training, team members can receive instruction at a Microsoft Authorized Technical Education Center and participate the Certified Professional program. Call (800) SOLPROV (or (800) 765-7768) for information about authorized training offered for Windows 95 and the Certified Professional program, and for referral to a local Microsoft Solution Provider Authorized Technical Education Center (ATEC).

For additional information about Windows 95, particularly the background of its design and the history of its development, team members can read *Inside Windows 95* from Microsoft Press. This book contains guidelines and tips for applications developers working with Windows 95.

For other training information, see [Windows 95 Resource Directory](#).

Deciding on the Preferred Client Configuration: The Details

Detailed analysis is required to determine your preferred client-computer configuration. Starting with the ideal configuration, which uses the most functional and best-performing client software, evaluate each feature against your organization's needs and environment to determine whether the feature is appropriate and compatible. If you are considering different configuration alternatives, repeat this evaluation for each configuration.

The following sections describe feature options and decisions to evaluate in specifying the network client configuration.

Deployment Strategy and Details

Deciding on the Preferred Client Configuration: The Details

Configuration Layout

When deciding where to place Windows 95 files, consider how the computer will be used and evaluate the benefits of each placement option. If the computers are personal workstations, or portable computers that occasionally connect to the network, or are used in workgroups that only share data and applications such as word processors (not operating system software), then you might want to install Windows 95 executable files and applications on the local hard disk and run these locally. Swap files and TEMP files are also located on the local hard disk. The network is used only to store commonly used data.

On the other hand, if you want to run a shared copy of Windows 95 on computers that do not have hard disks or to provide a central location for managing users' system configurations, then you would install Windows 95 files so that all Windows 95 executable files and applications run from the network. All data is saved on the network. Swap files and TEMP directories are placed on network drives.

Support for diskless workstations is available for NetWare networks with the initial release of Windows 95. For information about support under Windows NT, contact your Microsoft sales support representative.

Deployment Strategy and Details

Deciding on the Preferred Client Configuration: The Details

Key Features of the Ideal Configuration

This section provides detailed discussions of the features which might be included in an ideal network client configuration.

Deployment Strategy and Details

Deciding on the Preferred Client Configuration: The Details

Key Features of the Ideal Configuration

Using a 32-bit, Protected-Mode Network Client

For best performance, select a network client that uses a 32-bit redirector for network access. Windows 95 includes the 32-bit Microsoft Client for NetWare Networks and the Client for Microsoft Networks; each of these has a 32-bit redirector. The benefits of using a 32-bit, protected-mode client include the following:

- Provides for easy installation and configuration using built-in Windows 95 tools
- Uses no real-mode memory
- Provides faster data I/O across the network
- Offers greater stability than real-mode redirectors
- Allows more than one redirector to be run at one time, and thereby enables access to servers for multiple networks without having to reload the operating system for a new network client
- Makes networking seamless in the Windows 95 user interface; users can browse the server for multiple networks in Network Neighborhood, all within the same name space — users don't need to know which type of network they are browsing

If you are using another type of network, contact your network vendor regarding the availability of a 32-bit, protected-mode network client. If a protected-mode client is unavailable, you can run a protected-mode Windows 95 client such as Client for Microsoft Networks in conjunction with a real-mode network client.

Deployment Strategy and Details

Deciding on the Preferred Client Configuration: The Details

Key Features of the Ideal Configuration

Using a 32-bit, Protected-Mode Protocol

If you select a 32-bit, protected-mode network client, then by default Windows 95 also sets up a 32-bit, protected-mode protocol. Even if you are running a real-mode client such as the Novell® 3.x workstation shell (NETX) with a real-mode implementation of IPX/SPX to access NetWare® servers, you can still load the 32-bit version of the Microsoft IPX/SPX-compatible protocol. The benefits of adding the protected-mode protocol are better performance and better stability for network communications to servers that are not running NetWare (for example, computers running Windows 95 or Windows NT).

In addition, for protocols such as TCP/IP, the Microsoft 32-bit version enables additional functionality such as the ability to use DHCP and WINS servers that dynamically set the IP addresses and resolve computer names for client computers on the network. Each protocol has a number of benefits, as discussed in [Network Technical Discussion](#).

Deployment Strategy and Details

Deciding on the Preferred Client Configuration: The Details

Key Features of the Ideal Configuration

Using the Latest Network Adapter Drivers

For best performance, use the latest network adapter drivers available. These should be NDIS 3.1-compatible drivers which provide Plug and Play capabilities. Such drivers take up no real-mode memory and can be loaded or unloaded dynamically as required.

The only instances in which you wouldn't use the latest drivers are:

- The newest driver isn't available for your network adapter.
- Your site requires ODI cards and drivers.

Deployment Strategy and Details

Deciding on the Preferred Client Configuration: The Details

Recommended Features for Network Clients (Optional)

The following optional features are recommended for your preferred configuration. These features define how Windows 95 will be installed and administered in your organization.

Deployment Strategy and Details

Deciding on the Preferred Client Configuration: The Details

Recommended Features for Network Clients (Optional)

Using System Policies

For centralized administration of client computers, you must enable system policies. System policies allow you to centrally edit and control individual user and computer configurations. For example, if you want to place a custom Start menu on user desktops or limit access to Control Panel options, system policies make it easy to do this from a central location for a large number of users.

Enabling policies creates a single file that resides on the server, and thus does not involve physically touching the client computer. In general, the policy file can be modified on the server after Windows 95 is installed; however, some types of changes, such as adding group support or a nonstandard server path for product updates, require configuration on the client computer. For information on the types of restrictions available and for details on how to implement system policies, see [User Profiles and System Policies](#).

Deployment Strategy and Details

Deciding on the Preferred Client Configuration: The Details

Recommended Features for Network Clients (Optional)

Using User Profiles

With user profiles, users can use personalized desktop settings each time they log on to a computer. This is especially useful for multiple users sharing a single computer who want to customize their desktops and have those custom settings loaded at logon. Conversely, a single user can move between computers using the same profile if the administrator stores that profile on the server. An administrator can also take advantage of profiles to require that a mandatory desktop configuration be loaded each time a user logs on. The ability to change profile settings can be controlled by the administrator. For information on how to use user profiles, see [User Profiles and System Policies](#).

User profiles are not needed when only one person uses the computer or when a custom desktop adds no value. By not enabling user profiles, the logon process is shortened slightly, because the system does not need to locate and load the profile.

Deployment Strategy and Details

Deciding on the Preferred Client Configuration: The Details

Recommended Features for Network Clients (Optional)

Enabling Remote Administration

To remotely administer a computer's Registry, you must first install the network service called Microsoft Remote Registry service, enable user-level security, and enable the Remote Administration feature. Remote administration capabilities allow you to conduct a variety of tasks remotely over the network such as administering the file system, sharing or restricting directories, or querying and making changes to the Registry. If you plan to do any of these tasks, be sure to enable this feature during Windows 95 installation.

You should not enable remote administration if you don't need these services, because doing so causes unnecessary, extra processes to run on the client computer and on the network. These extra remote services could then *theoretically* be used by individuals on the network— provided they knew the appropriate password — to access information on client computers. However, Windows 95 comes with security capabilities to protect against unauthorized use of the Remote Registry service. For more information, see [Remote Administration](#).

Deployment Strategy and Details

Deciding on the Preferred Client Configuration: The Details

Recommended Features for Network Clients (Optional)

Using Setup Scripts for Windows 95 Setup

Setup scripts (which are batch files) allow you to predefine responses to prompts that appear during Windows 95 Setup. Setup scripts go hand-in-hand with push installations to completely automate the installation process. The choice to use a setup script is very straightforward. If you need to conduct a similar installation more than five times, you should use a setup script. Begin planning for setup scripts and push installations during this phase, as you are specifying the preferred client configuration. Make sure that you document each feature needed, so that you can automate the selection of these features. For more information, see [Custom, Automated, and Push Installations](#).

Deployment Strategy and Details

Deciding on the Preferred Client Configuration: The Details

Recommended Features for Network Clients (Optional)

Using Push Installations for Windows 95 Setup

You need to understand and plan in advance how the push installation process will work for a given computer. There are several alternatives for remotely initiating the installation, ranging from editing the client's login script, to sending by electronic mail a link that contains a setup script. You will want to consider how to push the installation for each computer and make sure that the client computers are configured to support this process.

For organizations with 50 or more computers, being physically present to install each client computer is not a viable option because of the cost. In that case, you may need to turn to an administrative software solution such as Microsoft Systems Management Server. When using administrative software tools, additional client-side software may be needed. Be sure to include this software in the installation plan.

For more information about using push installations, see [Custom, Automated, and Push Installations](#).

Deployment Strategy and Details

Deciding on the Preferred Client Configuration: The Details

Recommended Features for Network Clients (Optional)

Using Peer Resource Sharing Services

The peer resource sharing capability in Windows 95 allows your client computers to share files and printers directly from a local personal computer, instead of on a central server. Peer resource sharing may reduce the traffic and disk space required on central servers, because you are leveraging the power of individual computers.

Security for peer resource sharing services may take the form of user-level security based on the user accounts on a Windows NT or NetWare network. Notice that a Microsoft Windows NT Client Access License is required if the computer will be connecting to servers running Windows NT Server. For information, see [Windows 95 on Microsoft Networks](#), or contact your Microsoft reseller.

If you don't have servers to provide security validation or don't want to use user-level security, you can use share-level security, with each individual implementing security and a password scheme on the local computer. Share-level security is set on a directory-by-directory basis.

If you do not want to use peer resource sharing services and want to disable the capability on each client computer, you can do so by selecting the appropriate option in system policies.

Deployment Strategy and Details

Deciding on the Preferred Client Configuration: The Details

Recommended Features for Network Clients (Optional)

Using User-Level Security

User-level security is based on user account lists stored on Windows NT or Novell NetWare servers. The user accounts specify which users have access rights on the network. Windows 95 passes on a user's request for access to the servers for validation. Pass-through user-level security protects shared network resources by requiring that a security provider authenticate a user's request to access resources.

User-level security is required for remote administration of the Registry and for network access to full user profiles. For information on implementing security in Windows 95, see [Security](#).

Deployment Strategy and Details

Deciding on the Preferred Client Configuration: The Details

Other Optional Features

The following features may be useful in your organization. Review the related discussion before making a decision.

Deployment Strategy and Details

Deciding on the Preferred Client Configuration: The Details

Other Optional Features

Using Microsoft Exchange Mail

The new Microsoft Exchange feature in Windows 95 manages all messaging information in one place, with a single inbox for electronic mail, faxes, and other messages. In addition, Windows 95 comes with a complete small-business mail system — that is, a mail client and a postoffice — that allows users to exchange electronic mail through a single postoffice. This mail client integrates well with Microsoft Mail servers, and the postoffice can be upgraded to provide an enterprise mail system.

You can also use a variety of other mail or messaging systems through Microsoft Exchange as long as they use a MAPI 1.0 driver. If you have an existing mail system that doesn't use a MAPI 1.0 driver, you can continue to use that mail system without running the Microsoft Exchange Mail capability. In this case, you would install Microsoft Exchange only if you wanted to use the Microsoft Fax capability so that incoming faxes are collected by Microsoft Exchange. For more information, see [Electronic Mail and Microsoft Exchange](#) and [Microsoft Fax](#).

Deployment Strategy and Details

Deciding on the Preferred Client Configuration: The Details

Other Optional Features

Using Microsoft Fax

Microsoft Fax provides a built-in fax capability that allows a computer running Windows 95 to send and receive faxes as bitmap and binary files without any additional software. It also allows users within a Windows 95 workgroup to share a fax modem, but if you have an existing fax server in your organization, you should probably continue to use that server for computers on the network. In that case, Microsoft Fax features would still be useful for portable computer users who travel. For more information, see [Microsoft Fax](#).

Deployment Strategy and Details

Deciding on the Preferred Client Configuration: The Details

Other Optional Features

Using Dial-Up Networking

This client software allows the computer to use popular, server-based dial-in packages such as Windows NT RAS, Novell NetWare Connect, and Shiva NetModem. Dial-Up Networking provides additional security for remote dial-up connections and requires some additional configuration of protocols and software. For more information, see [Dial-Up Networking and Mobile Computing](#).

Deployment Strategy and Details

Deciding on the Preferred Client Configuration: The Details

Other Optional Features

Using The Microsoft Network

The Microsoft Network is an online service that offers chat capability, information bulletin boards, and electronic mail. It is the best place to obtain Microsoft product information and technical support. For more information, see [The Microsoft Network](#).

Deployment Strategy and Details

Deciding on the Preferred Client Configuration: The Details

Other Optional Features

Using Disk Management Tools

Windows 95 ships with useful disk tools such as disk compression and defragmenting utilities that run from within Windows 95. The disk compression utility upgrades DoubleSpace® and DriveSpace™ programs from MS-DOS 6.2x. For details, see [Disks and File Systems](#).

Deployment Strategy and Details

Performing the Lab Test: The Details

This phase in the deployment process involves four significant efforts: preparing the site, conducting the installation, testing the installation, and restoring the system.

Deployment Strategy and Details

Performing the Lab Test: The Details

Preparing the Test Site and Equipment

Preparing the site involves ensuring that the location of each computer, the computer itself, and the hard disk in particular are all ready for Windows 95 to be installed. In terms of the physical site, make sure that you have the appropriate jacks for connecting to the network.

For the computer itself, make sure that it has the appropriate hard disk space, RAM (at least 4 MB, but 8 MB is recommended), and processor (386DX or better is recommended) to run Windows 95. To review the requirements for running a shared copy of Windows 95 from a server, see [Server-Based Setup for Windows 95](#).

In addition, run virus detection, disk scanning, and defragmentation programs on the computer to correct any problems prior to installation. Although the computer may appear to be operating properly, software upgrades often uncover hardware or software problems, because of the way they read and write data to the hard disk. Correct any such problems before installing Windows 95.

Lastly, when preparing the site, be sure to back up critical data and configuration files for the system, in case the installation fails or you need to revert to the previous operating system for some reason. This includes backing up INI files (such as WIN.INI and SYSTEM.INI), GRP files, AUTOEXEC.BAT, CONFIG.SYS, and all key data files. As an added precaution, create a system startup disk and back up the Windows and DOS directories and all the files in the root directory.

If you need to automate the restoration, consider using a commercial backup program, instead of copying the files by hand.

Deployment Strategy and Details

Performing the Lab Test: The Details

Installing Windows 95 on Test Computers

Before setting up Windows 95 for the first time, verify that the computer's existing network is working properly. Then use Installation, in the *Windows 95 Resource Kit* to help you install and configure Windows 95 correctly. Custom, Automated, and Push Installations includes instructions on how to automate the installation process using setup scripts. Take note of which options you want to predefine as entries for the MSBATCH.INF file used for the setup script.

Testing the Installation

After you've set up a computer with Windows 95, you'll need to run a variety of tests to make sure that it runs correctly on your network and that you can still perform all of your usual tasks. Use your own testing methodology or test the following to verify correct system operation:

- Connect to and browse the network
- Set up a printer and test printing to local and network printers
- Open, run, and close applications on both the client computer and on the server
- Shut down completely

Make sure to test all mission-critical applications for proper function. If you encounter problems, try removing related features from the proposed configuration as a solution. Document any changes made to the original configuration.

If the preferred client configuration works as expected, you may also want to conduct additional testing of the optional software features and components in Windows 95. This can help you determine whether you are running Windows 95 optimally. For this kind of testing, conduct side-by-side evaluations on two computers, changing individual features on each one, to determine the following:

- Performance in terms of responsiveness and throughput
- Ease of use
- Stability
- Compatibility
- Functionality

To evaluate network client software for Novell NetWare, run your network performance tests in the following configurations:

- Windows 95 installed with an existing 16-bit, Novell-supplied workstation client (NETX), using ODI drivers
- Windows 95 added to an existing installation of Windows 3.x and NetWare, using Client for NetWare Networks and protected-mode networking support components (NDIS adapter drivers)
- Windows 95 as a new installation using all protected-mode components, including both Client for NetWare Networks and Client for Microsoft Networks, plus peer resource sharing support

Perform several common tasks such as connecting to the network, administering a remote NetWare server, and so on, to test for ease of use. Similarly, you'll want to run any business-specific NetWare applications under Microsoft Client for NetWare Networks to make sure that they run compatibly. Any stability issues should become apparent during this testing.

When you have identified a configuration that performs well during testing, test the same configuration using other hardware from your company.

See [Networking](#), in the *Windows 95 Resource Kit* to understand the differences in functionality between network clients.

Deployment Strategy and Details

Performing the Lab Test: The Details

Testing the Restoration Process

After thorough testing of the preferred client configuration, completely restore one of the test computers to the previous client configuration and document the process. The degree to which you need to test and restore the computer depends on the tools available. [Setup Technical Discussion](#) documents how to remove Windows 95 and restore the previous operating system manually.

Deployment Strategy and Details

Planning the Pilot Rollout: The Details

This phase involves three major efforts: automating the installation, documenting the logistics of the pilot installation, and preparing the user training plan. These efforts are a combination of planning and lab-testing work.

Deployment Strategy and Details

Planning the Pilot Rollout: The Details

Installing the Source Files for Setup

You need to designate a network server that will be used as the source file installing Windows 95 over the network using custom setup scripts. Then use Server-based Setup to install Windows 95 source files on a server. This program is available only on the Windows 95 compact disc (in the ADMIN\NETTOOLS\NETSETUP directory).

You must make choices based on your client configuration, including whether client computers will run a shared copy of Windows 95 from the server, or run Windows 95 locally from the hard disk.

See [Server-Based Setup for Windows 95](#), for step-by-step instructions. Document any changes to this process.

Automating the Installation

Automating the installation is a key step in reducing the cost of migration. By creating a setup script with predetermined answers for installation questions, the installation process can run from start to finish without user intervention. It is also possible to “push” the installation from the server, so that you can install Windows 95 on an individual personal computer without ever touching the computer. This automation work is done in the lab, prior to conducting the pilot rollout.

Automating the installation consists of creating a setup script, setting up Windows 95 on the server, and creating a push installation process. With a setup script you can perform a “hands free” installation, so that the user need not respond to any prompts or even touch the computer during Windows 95 Setup.

Setting up Windows 95 on the server requires the Server-based Setup program (NETSETUP.EXE) from the Windows 95 compact disc. Installing Windows 95 source files on the server is a separate and distinct process from the Windows 95 Setup program (SETUP.EXE) that you ran in the initial lab installation.

When you run Server-based Setup to install source files on the server, you can also create a default setup script, and you can specify whether the Windows 95 source files on the server will be used to set up Windows 95 to run locally from a single computer or to run a shared copy from the server for client computers that require a shared installation.

Depending on the common network configuration at your site, you may determine that you need to remove a line from one or more configuration files as a global procedure before starting Windows 95 Setup. For example, you may want to use a protected-mode protocol such as Microsoft TCP/IP during Setup instead of the real-mode version of TCP/IP currently used on the target computers. In addition, users may be running certain TSRs or applications that should be closed before running Windows 95 Setup. In these cases, you can modify NETDET.INI on NetWare networks as described in [Windows 95 on NetWare Networks](#). On other networks, including Microsoft networks, modify the [Install] section of MSBATCH.INF to automate these changes. (For more information, see [MSBATCH.INF Parameters](#).)

In addition, you may want to manually add other files to the shared directory on the server, such as custom bitmaps for screens or a predefined WKGRP.INI file for workgroup organization, so that client computers are fully configured when Windows 95 is installed.

Creating a push installation process involves doing some final work on the server, such as editing the login script for the user, or sending a link in electronic mail to a batch file that runs Windows 95 Setup, so that the user only needs to log on or double-click an icon to start the installation. System management software such as Microsoft Systems Management Server can also be used to start the installation centrally. If you plan to use system management software in automating the installation, make sure this has been acquired and tested.

For more information, see [Custom, Automated, and Push Installations](#).

Documenting Rollout Logistics

This task involves determining the timing and the process for pilot installation and choosing the pilot user group.

Although it is a test, the first pilot rollout sets the tone for and presents an example of the final rollout, so it is important to be completely prepared with all aspects of the rollout. This requires that you determine the time it will take for installation, the personnel and tools needed to facilitate the process, and the overall schedule.

Start by identifying the target computers and their location. Then use the following list as the basis of your checklist for rollout logistics:

- Has a verified backup been performed for each of the target computers?
- Have passwords been reset for CMOS, the network, and applications?
- Have virus checking and disk defragmentation been performed?
- How many systems will be installed per day? Start with a conservative estimate and then increase or decrease the number, based on your experiences with the initial installations.
- At what time of day should the installations occur? You may want to schedule installations to occur on weekdays after normal business hours or on weekends.
- Who are the pilot users? Choose a pilot user group or department that is willing and able to accommodate the rollout. This group, ranging from 15 to 50 persons, should be representative of your overall user base. Try not to select a department that is attempting to meet a schedule deadline during the rollout, or a group that is traditionally slow in adopting new technology.
- What is the schedule for pilot installations? When determining the installation time for the pilot rollout, base the projections on how long it takes for installation of an individual computer; remember to schedule the downtime for each user.
- Who will participate in the installations? In addition to the Installation team members, be sure to assign a system administrator with full rights on the server, including the right to administer mail or database server passwords.
- Is the deployment methodology as automated as possible?

As you develop the checklist of logistics, consider your goals for the pilot rollout and the factors that define its success. For example, you might set a percentage for successful upgrades or for automated installations that, if achieved, would indicate that the rollout had been successful. Document these goals and criteria, so that teams can monitor performance against them during the rollout.

Deployment Strategy and Details

Planning the Pilot Rollout: The Details

Notifying Users of the Rollout

Another step at this stage is informing users about the pilot rollout plan. You can use a videotape presentation, an interoffice memo, or a company meeting as the means for communicating with users about the rollout. But, regardless of the form used, the message must explain to users the benefits of moving to Windows 95, and describe the overall plan and process by which each group or department will make the move. This makes it easier for your users to plan for and accept the migration to Windows 95 as part of their schedules.

Developing User Training

The first steps in developing a training plan are to acquire a training lab, set up computers in the lab, and appoint a team member as instructor. (If in-house resources are not available, use a vendor to develop and conduct the training.) The instructor will be responsible for creating and testing the training program.

There are a number of training approaches and a variety of tools you can use. A recommended approach is to divide the training into sessions corresponding to three distinct topics: The Basics, Corporate-Specific Applications, and Customization.

The session entitled “The Basics” includes the top 10 functions any user needs to know to accomplish daily work, such as the following:

Function	To do the function, use this
Run programs, load documents, find a file	Start button
Change settings	Control Panel
Get help on a specific topic	F1 or Help command
Switch between applications	Taskbar
Minimize, maximize, and close windows	Window buttons
Browse your hard disk	My Computer and Windows Explorer
Connect to a network drive	Network Neighborhood
Print a document	Point and Print

The Windows 95 online Help and *Introducing Microsoft Windows 95* supplied with the product disks provide the information you need to train users in the basics. Schedule training sessions of no more than 30 minutes each; in each session, users receive information that is *just enough* to be productive using Windows 95.

The “Corporate-Specific Applications” session varies by the environment and the types of applications run on the network. This session should focus on the top 5 to 10 functions that will change because of the upgrade to Windows 95.

The “Customization” session is intended for more experienced users. The purpose of this session is to provide information and guidance that will help these users learn on their own after the training, and teach them how to work more productively with Windows 95. Some of these topics could include:

- Adding items to the Start button
- Adding items to the desktop (move, copy, shortcut)
- Using options controlled by the right mouse button
- Adding a new device (for example, a printer)
- Changing the desktop (for example, screen saver settings)

After creating and testing the program, schedule training sessions to occur immediately before the rollout so that the instruction is *just in time*, ensuring that users retain most of what they learn by putting it to use right away.

Deployment Strategy and Details

Planning the Pilot Rollout: The Details

Developing the Support Plan

Similar to the training plan, the support plan must be ready to go online the first day you begin performing Windows 95 installations. Because the quality of support that's available during the pilot rollout will be seen as an indicator of the quality of the rollout as a whole, it is important that you plan carefully to make sure effective support is available.

Staff the Support team for your pilot rollout with some of your best technicians dedicated solely to the pilot group for the first few weeks. The assigned technicians should carry pagers or be available by phone at all times, to give immediate assistance to users.

And, to help users help themselves, edit Windows 95 Help with company-specific information on applications or features. Doing so requires placing an OEM.CNT file and your custom help file in the user's Windows directory. For information about OEM.CNT and the format of Windows 95 help files, see the *Win32 Software Development Kit for Windows 95 and Windows NT*.

Deployment Strategy and Details

Conducting the Pilot Rollout: The Details

This phase consists of simulating the final installation process, testing the capabilities and performance of the system, surveying user feedback, and making adjustments as needed.

Repeat this pilot rollout process for 32-bit applications.

Deployment Strategy and Details

Conducting the Pilot Rollout: The Details

Simulating the Installation Process

The schedule for the pilot rollout should simulate — on a smaller scale — the schedule of the final rollout. As you conduct the pilot rollout, you may find that certain tasks take more or less time than expected, that some tasks need to be added, or that some tasks can be left out. Modify the pilot rollout schedule to account for such changes, and use the pilot schedule for projecting the final rollout timetable.

Deployment Strategy and Details

Conducting the Pilot Rollout: The Details

Testing Windows 95 Performance and Capabilities

In addition to the technicians responsible for conducting the pilot installation, extra technicians should be assigned to measure, observe, and test the installation. By tracking the time per installation, handling problems that arise, and identifying areas for improvement or automation, these individuals help make sure the success of both the pilot and final rollouts by making the installation more efficient.

In addition, after Windows 95 is installed, these technicians test system capabilities, such as remote administration, for proper operation and monitor the client computers for performance, stability, and functionality, highlighting any inconsistencies with the lab configuration.

Deployment Strategy and Details

Conducting the Pilot Rollout: The Details

Surveying Users for Feedback

The final part of the pilot rollout involves surveying the users to gauge their satisfaction and proficiency with the new installation and to evaluate the level of training and support provided. Test users' proficiency by having them perform a few common tasks or use several of the new features in Windows 95 — for example, have these users register their survey results on the server.

When collected, combine the survey results with the ideas for improvements identified during the pilot rollout. Use this information to prepare a checklist of open issues which must be resolved prior to the final rollout. Then assign team members to take the actions necessary for solving problems or making improvements. Indicate on the checklist how and when each item was resolved, adjusting the deployment plan if appropriate.

Deployment Strategy and Details

Finalizing the Rollout Plan: The Details

The final rollout plan is an extension of the pilot planning process, with the added steps of documenting, budgeting for, and carrying out the final logistics. As you perform these steps, you should also update the policies and practices guidelines governing network and computer use in your company, and create a template for a central database that tracks specific configurations and uses of each network computer.

Deployment Strategy and Details

Finalizing the Rollout Plan: The Details

Completing the Rollout Logistics and Budget

As you prepare for final rollout, estimate the length and scope of the overall installation process. Also plan for all tools needed to complete the process within the stated timeframe. If necessary, propose a formal budget for the company-wide implementation and present it to management for approval. Your budget should include the costs for personnel and resources such as system management software.

After obtaining any necessary approval, purchase the resources required to facilitate the installation. If you need additional staff, be sure to hire experienced and qualified individuals for the team, and train them extensively before getting started.

Complete your training, communication, and staffing plans for the final rollout at this time.

Deployment Strategy and Details

Finalizing the Rollout Plan: The Details

Updating the Policies and Practices Guidelines

Prior to final rollout, update all company policies regarding the use of the network and computers by employees. Make sure to cover items such as password length and expiration requirements, and the level of approval needed to obtain remote dial-up privileges.

In addition, update the corporate standards lists for hardware and software usage; use this as a reference for bringing all computers into compliance during the rollout process.

Because Windows 95 enables the use of many new 32-bit applications and of Plug and Play-compliant hardware, these new products should be added to the list, and their older counterparts should be deleted.

Deployment Strategy and Details

Finalizing the Rollout Plan: The Details

Creating a Template for the Rollout Database

A template is used to create a central database for monitoring the progress of the rollout and to document any areas requiring further action. During preparations for the final rollout, create the template, using appropriate database management software. Complete the template with configuration information for every computer and user in the company, and place the template on the server. Then, during company-wide installation, the Installation team fills in the template for each computer and user, indicating whether any additional upgrading is needed. The team can then use the template to track open items following the rollout and to measure actual progress against original objectives.

Rolling Out Windows 95: The Details

Following weeks of planning, organization, testing, communication, and training, the deployment teams and your organization as a whole should be ready for full-scale rollout of Windows 95. The extensive preparation for this event may make deployment seem almost routine for the teams involved; however, that's exactly the kind of uncomplicated rollout a systems administrator dreams of. And, soon after the installations, users may not know how they got their work done without Windows 95. If this happens in your company, then you know your rollout has been a success!

The information in this chapter has been provided to assist organizations in achieving a smooth migration with Windows 95. The remainder of this Resource Kit contains information intended to illustrate other benefits and capabilities of your Windows 95 implementation. Following this Planning Guide, information is presented in these parts:

- [Installation](#)
- [Networking](#)
- [System Management](#)
- [System Configuration](#)
- [Communications](#)
- [Windows 95 Reference](#)
- [Appendixes](#)

Installation

This part of the *Windows 95 Resource Kit* contains the following chapters which describe how to set up Windows 95.

Chapter 3 Introduction to Windows 95 Setup

Describes installation requirements for installing Windows 95, provides an overview of the types of Windows 95 installations available, and presents a step-by-step description of how Windows 95 Setup installs Windows 95 to run on the local hard disk of a single computer.

Chapter 4 Server-Based Setup for Windows 95

Describes how to prepare the server for running Windows 95 Setup from a shared directory, and provides the procedures for installing Windows 95 to run from a shared copy of source files on the network, including setup for remote-boot and floppy disk-based workstations.

Chapter 5 Custom, Automated, and Push Installations

Describes how to customize Windows 95 using setup scripts, policy files, and other options. This chapter also provides procedures for automating Windows 95 Setup so that users do not have to make choices and administrators can ensure installation results.

Chapter 6 Setup Technical Discussion

Describes the internal setup and system startup processes, and provides procedures for installing Windows 95 on computers that have operating systems other than MS-DOS. This chapter also describes how to remove Windows 95 from a computer.

Introduction

This chapter presents requirements for installing Windows 95, provides an overview of the types of Windows 95 installations available, and presents a step-by-step description of running Windows 95 Setup to install Windows 95 on the local hard disk of a single computer.

Important Before running Windows 95 Setup, read the SETUP.TXT file on Disk 1 of the Windows 95 floppy disks or on the compact disc for information about hardware and software that might already be installed on your computer.

- Windows 95 Setup Overview
 - Quick Start for Windows 95 Setup
 - New Windows 95 Setup Features
- Installation Requirements
 - Operating System Requirements
 - Requirements for Windows 95 Setup
 - System Requirements for Windows 95
 - Partition Requirements
- Options for Windows 95 Installations
 - Deciding to Run Setup from MS-DOS or Windows
 - Deciding to Use Typical, Portable, Compact, or Custom Setup
 - Deciding Between Local and Shared Installation
 - Deciding to Use Customized or Automated Setup
 - Deciding to Use Maintenance or Repair Setup
- Before Starting Windows 95 Setup
- Starting Windows 95 Setup
 - Using Setup Command-Line Switches
 - Beginning Windows 95 Setup and Safe Recovery
- Running Windows 95 Setup
 - Gathering Information
 - Analyzing the Computer
 - Selecting Software Components
 - Selecting Network Components in Custom Setup
 - Specifying Computer Identification
 - Changing Computer Settings in Custom Setup
 - Creating a Startup Disk
 - Copying Files and Completing Setup

Windows 95 Setup Overview

This section provides a brief summary of the installation steps in Windows 95 Setup, plus an overview of the new features in Windows 95 Setup.

This information is designed to provide a fundamental description of Setup for administrators who are responsible for installing Windows 95 on many computers. However, the information provided here will also help individuals who are installing Windows 95 on the local hard disk of their personal computers.

Note In the *Windows 95 Resource Kit*, “local computer” refers to a personal computer with Windows 95 system files installed on the local hard disk; a local computer running Windows 95 can also include networking software.

The term “shared installation” is used to refer to a computer that runs a shared copy of Windows 95 from a network server, with few or no Windows 95 files installed on the local workstation.

Quick Start for Windows 95 Setup

The following are the basic tasks you perform when installing Windows 95 on a computer for the first time:

1. Check that the computer's hardware is supported and meets the minimum requirements for Windows 95. Close all applications and disable unnecessary TSRs. Check and defragment the hard drive, and back up key files. These tasks are described in [Before Starting Windows 95 Setup](#).
2. Start Windows 95 Setup.
How you start Setup depends on whether you are running Setup from floppy disks, a CD-ROM compact disc, or a shared network directory. For information, see [Starting Windows 95 Setup](#).
3. Choose the directory where you want the Windows 95 system files to be installed on the computer. If you want to preserve your existing Windows and MS-DOS operating system, you must install Windows 95 in a new directory, as described in [Gathering Information](#).
4. Choose the type of setup: Typical, Compact, Portable, or Custom. For most users, Microsoft recommends the Typical Setup, which installs standard options with default settings. For information, see [Deciding to Use Typical, Portable, Compact, or Custom Setup](#).
5. Provide identification information about your user name, computer name, and other identifiers. For information, see [Providing User Information](#) and [Specifying Computer Identification](#).
6. If you choose Custom Setup, you must specify the options you want to install and make other choices about the system components, including networking. For information, see [Selecting Software Components](#), [Selecting Network Components in Custom Setup](#), and [Changing Computer Settings in Custom Setup](#).
7. Create a startup disk for emergency recovery, as prompted by Windows 95 Setup. This is a highly recommended step. For information, see [Creating a Startup Disk](#).
8. Restart the computer after Setup copies the required files. Then, depending on the type of installation, select the local time zone and complete other tasks for configuring certain devices and software. For information, see [Copying Files and Completing Setup](#).

Windows 95 Setup automatically guides you through each of these tasks and provides Help for any step if you need it before proceeding.

New Windows 95 Setup Features

Windows 95 Setup ensures easier installation and also offers greater flexibility and better customization options than earlier versions of Windows. The following list summarizes these improvements.

A complete Windows-based setup process.

Windows 95 Setup provides better visual feedback and greater flexibility for navigating through the setup process than was available for Windows 3.x. Windows 95 Setup runs entirely from within the Windows environment, even if an earlier version of Windows 3.x is not already on the computer. The Windows 95 Setup wizard leads users through the process of choosing all configuration options. After all choices have been made, Windows 95 Setup proceeds without further user actions.

Modular architecture for Setup.

To make installation easier and more flexible, the Windows 95 development team completely rewrote the installation code. Windows 95 Setup also incorporates the use of safe defaults and mechanisms for automatically configuring or installing all components with minimal user intervention.

Improved hardware device detection and configuration support.

Windows 95 Setup detects the hardware devices and components already configured on the computer and uses this information to install drivers and set Registry entries. Windows 95 provides more versatile detection and configuration for a wider range of devices than was available for Windows 3.x. For information, see [Setup Technical Discussion](#).

Safe Recovery for Setup failures.

Windows 95 Setup provides a recovery mechanism in the case of Setup failure. Safe Recovery uses a log that is maintained throughout the setup process. If Setup fails — for example, due to problems during hardware detection — the last entry in the Setup log identifies where the process was interrupted. When you rerun Windows 95 Setup, it uses the log to bypass the module where the problem occurred. During Setup (and during subsequent maintenance of Windows 95), Windows 95 also creates and maintains a log of installed components. For information, see [Setup Technical Discussion](#).

Network installation integrated with Windows 95 Setup.

These elements are summarized in [Selecting Network Components in Custom Setup](#). For more information, see [Networking](#).

Improved customization of installation.

Windows 95 provides easier, more flexible customization of Setup than was available for Windows 3.x, giving you better control for configuring desktop settings, network components, and hardware devices. System administrators can simplify installation for users by using setup scripts that define required settings. Installation of Windows 95 using setup scripts is more flexible and full-featured than for Windows 3.x, and it includes the option for hands-free “push” installation with no user intervention. For information, see [Custom, Automated, and Push Installations](#).

Installation Requirements

There are requirements for running Windows 95 Setup in addition to the requirements for installing and running Windows 95 on a computer. This section lists the following kinds of requirements:

- Operating system requirements
- Windows 95 Setup memory, disk space, and user information requirements
- Windows 95 hardware, disk space, partition, and other requirements

Operating System Requirements

You must install the retail version of Windows 95 as an upgrade over an existing operating system. You can install Windows 95 over a number of different operating systems, including MS-DOS, Windows, and Windows for Workgroups. Windows 95 can also be installed over Novell® DR DOS® (or Novell DOS™), PC-DOS, and OS/2, and as a dual-boot operating system with Windows NT.

The minimum operating system software required to install Windows 95 is any of the following:

- Recommended for MS-DOS version 4.01 or higher, or equivalent OEM versions; can also be installed under MS-DOS version 3.2 or higher with 35-45 MB of free space available on a single partition
- Windows 3.x
- Windows for Workgroups 3.1x
- Dual-boot OS/2 (with MS-DOS)
- Dual-boot Windows NT (with MS-DOS)

Tip for MS-DOS Versions and Windows 95 Setup

Windows 95 Setup attempts to install Windows 95 on a computer with an operating system version equivalent to MS-DOS 3.2 only if that version can exceed the 32-MB partition limit (such as COMPAQ® version 3.31) because the operational disk space requirements for Windows 95 can exceed the 32-MB partition limitation.

The computer must have MS-DOS version 3.2 or later. Because there are many variations of MS-DOS 3.2, Microsoft recommends that you upgrade to Windows 95 from MS-DOS version 5.0 or later.

To check the MS-DOS version, type **ver** at the command prompt.

For information about how Windows 95 Setup treats disk partitions created under other operating systems, see [Partition Requirements](#). For information about how Windows 95 Setup deals with the boot sector and installs files for dual-boot operation with other operating systems, see [Setup Technical Discussion](#).

Requirements for Windows 95 Setup

Usually, you need to supply very little information during Windows 95 Setup for a successful Windows 95 installation. The unique information required for a typical installation consists only of the following (which can be predefined in a custom setup script):

- User name
- Computer and workgroup names, if the computer is connected to the network

Windows 95 Setup needs at least 417K of conventional memory to run. The amount of disk space required for Windows 95 Setup varies, due to the types of hardware on the computer, the required drivers, and the optional components installed.

Approximate Disk Space Requirements for Windows 95

Installation option	Compact ¹	Typical
New installation	30 MB	40 MB
Windows 3.1 upgrade	20 MB	30 MB
Windows for Workgroups upgrade	10 MB	20 MB

¹ You might not get typical functionality for all Windows 95 features (including networking) with a compact configuration, as described in [Deciding to Use Typical, Portable, Compact, or Custom Setup](#)

System Requirements for Windows 95

The following table describes the basic hardware requirements for running Windows 95 from the hard disk of a local computer. Windows 95 is designed for computers that use Intel x86-based processors; it cannot be installed on any other processor. Windows 95 does not have symmetric multiple processor (SMP) support and, therefore, cannot take advantage of multiple processors (as Windows NT does). For information about requirements for shared installations, see [Server-Based Setup for Windows 95](#).

Component Windows 95 requirement

Computer	80386DX, 20 MHz (or higher) processor For installing Windows 95 to run from a local hard disk, a high-density floppy disk drive and hard disk drive are required. For installing Windows 95 as a shared installation, the computer does not need a hard disk or floppy disk drive. You cannot install Windows 95 on a 80386 computer that has a B-step processor (that is, with ID 0303).
Peripheral	Mouse or equivalent pointing device
Memory	4 MB of RAM (minimum); 8 MB (recommended) 8 MB are required for using Microsoft Exchange and The Microsoft Network, or for running multiple Win32®-based applications.
Video display	VGA (minimum); Super VGA (recommended)
Disk space	20 MB of free hard-disk space is required for a local installation. For information about requirements for a shared installation, see Server-Based Setup for Windows 95 . A custom installation requires a minimum of 19 MB. A compact installation requires 10 MB of disk space. You also need a certain amount free disk space for a swap file,

depending on how much RAM the computer has. As a guideline, you need at least 14 MB of memory, which can be divided between RAM and hard disk space. For example, if the computer has 4 MB of RAM, you need at least 10 MB of free disk space for a swap file. If the computer has 16 MB of memory, you will need very little disk space for a swap file.

Optional Modem (for The Microsoft Network and other components)
 CD-ROM drive
 Network adapter (required for networking)
 Sound card
 Other multimedia hardware components

Tips for Required Disk Space with Compressed Disks

If you have disk compression software installed, the required amount of uncompressed disk space on the host drive before installing Windows 95 depends on several factors:

- The type of compression used (Microsoft DriveSpace™ or DoubleSpace®, STAC Electronics Stacker®, and so on)
- The available free space on other drives
- The existence of a permanent swap file (if any), and its location
- The amount of available free space on other drives

If the computer does not have a swap file already, you might have to resize the host drive to accommodate the swap file requirements. For more information, consult your compression software documentation; see also [Disks and File Systems](#).

Introduction to Windows 95 Setup
 Installation Requirements

Partition Requirements

Windows 95 Setup cannot install Windows 95 unless a FAT partition exists on the hard disk. It cannot install Windows 95 on a computer that has only HPFS or Windows NT file system (NTFS) partitions. Windows 95 Setup reads most partitioning schemes and writes to the master boot record, unless disk partitioning schemes from other vendors are used.

The following table describes how Windows 95 Setup handles different types of disk partitions. For more information, consult the documentation for the related operating system.

Partition type	How Windows 95 Setup handles such partitions
MS-DOS (Fdisk and other vendors' partitioning software)	Windows 95 Setup recognizes and begins installation over existing MS-DOS FAT partitions, if the partition is large enough to accommodate Windows 95 files (including swap files). Windows 95 supports MS-DOS Fdisk partitions on removable media drives such as the Iomega® Bernoulli Box™ drives. Windows 95 recognizes and translates disk partitioning schemes created by other vendors' partitioning software, including Disk Manager DMDRVR.BIN and Storage Dimensions SpeedStor® SSTOR.SYS.
Windows NT	Windows 95 cannot recognize information on an NTFS partition on the local computer. Windows 95 can be installed on Windows NT multiple-boot systems if enough disk space is available on a FAT partition. On a Windows NT multiple-

boot system, Windows 95 Setup can either install Windows 95 on an existing FAT partition with MS-DOS and, optionally, Windows 3.x, or you must partition and format free space on the hard disk in a FAT partition, then perform a new installation onto this new FAT partition.

OS/2

You must run Windows 95 Setup from MS-DOS. If it is not already present on the computer, you must first install MS-DOS and configure the computer for dual-booting with OS/2.

Windows 95 works with disk compression drivers, including those in the following list. For more information, see [Disks and File Systems](#).

- Microsoft DriveSpace and DoubleSpace
- Stacker versions 3.0 and 4.x
- AddStor® SuperStor™

If you use other disk compression software, see the Windows README file, or contact your product support representative to determine compatibility.

Options for Windows 95 Installations

As either an individual user or a network administrator, you can choose from various options for Windows 95 installations:

- Run Windows 95 Setup from MS-DOS or Windows 3.x
- Install a typical, compact, or custom version on a desktop computer, or install Windows 95 for a portable computer
- Install Windows 95 system files locally or run a shared copy from a server
- Create customized and automated installations
- Use Windows 95 features to maintain or update an installation

These options are described in the following sections.

Deciding to Run Setup from MS-DOS or Windows

Windows 95 Setup is a protected-mode, 16-bit, Windows-based application. There are two different scenarios in which Windows 95 Setup can be run:

- From within Windows 3.1 or Windows for Workgroups 3.1x
- From MS-DOS at the command prompt (not from the MS-DOS Prompt under Windows)

The preferred method for running Windows 95 Setup is from within Windows 3.1 or Windows for Workgroups. Run Windows 95 Setup from MS-DOS when neither Windows 3.1 nor Windows for Workgroups is installed on the computer, but MS-DOS, OS/2, Windows NT, or Windows 3.0 is installed.

Setup detects whether Windows 3.1 or any version of Windows for Workgroups is installed on the computer, and, if it finds one of them, it offers to install Windows 95 in the same directory in order to upgrade the existing installation. If you choose to install in the same directory, Windows 95 Setup moves the configuration settings in SYSTEM.INI, WIN.INI, and PROTOCOL.INI, plus file associations from the Windows 3.x Registry into the Windows 95 Registry, so all applications and networking settings will work automatically in the new Windows 95 environment. Also, Windows 3.x Program Manager groups are converted to directories in the PROGRAMS directory, so that they can be displayed on the Windows 95 Start menu.

Note You must choose to install Windows 95 in a new directory if you want to preserve the existing MS-DOS or Windows installation. In this case, you might have to reinstall most Windows-based applications before they can function properly in the new environment.

Dual-boot capabilities are not enabled by default. For information about installing Windows 95 on computers with other operating systems and for information about configuring dual-boot options, see [Setup Technical Discussion](#).

Deciding to Use Typical, Portable, Compact, or Custom Setup

In Windows 95 Setup, you can choose from several types of installation option. The choice you make dictates the size of the Windows 95 installation on the computer (and, of course, the number of features installed) and the amount of control the user has in customizing the installation.

Setup type	Description
Typical	The default option, recommended for most users with desktop computers. Performs most installation steps automatically for a standard Windows 95 installation with minimal user action. You need to confirm only the directory where Windows 95 files are to be installed, provide user and computer identification information, and specify whether to create a startup disk.
Portable	The recommended option for mobile users with portable computers. Installs the appropriate set of files for a portable computer. This includes installing Briefcase for file synchronization and the supporting software for direct cable connections to exchange files.
Compact	The option for users who have extremely limited disk space. Installs the minimum files required to run Windows 95.
Custom	The option for users who want to select application and network components to be installed, and confirm the configuration settings for devices. Installs the appropriate files based on user selections. This type of Setup is recommended for experienced users who want to control various elements of Windows 95 Setup.

The following table compares many of the differences in components installed for Typical and Portable installations. For Custom Setup, the options selected by default are the same as for a Typical installation. For Compact Setup, no optional components are installed.

Components Installed for Typical and Portable Installations

Optional component	Typical	Portable
Accessibility Options	X	-
Audio Compression	-	-
Backup	-	-
Briefcase	-	X
Calculator	X	X
CD Player	-	-
Character Map	-	-
Clipboard Viewer	-	-
Defrag	X	X
Desktop Wallpaper	-	-
Dial-Up Networking	-	X
Direct Cable Connection	-	X
Disk Compression Tools	-	X
Document Templates	X	-
Games	-	-
HyperTerminal	X	X

Media Player	X	-
Microsoft Exchange	-	-
Microsoft Fax	-	-
Microsoft Mail Services	-	-
Mouse Pointers	-	-
Net Watcher	-	-
Object Packager	X	-
Online User's Guide	-	-
Paint	X	-
Phone Dialer	X	X
Quick View	X	X
Screen Savers	X	X
Sound and Video Clips	-	-
Sound Recorder	-	-
System Monitor	-	-
The Microsoft Network	-	-
Video Compression	X	X
Volume Control	-	-
Windows 95 Tour	X	-
WordPad	X	-

Introduction to Windows 95 Setup

Options for Windows 95 Installations

Deciding Between Local and Shared Installation

Windows 95 can run on the local hard disk of a computer or as a shared copy on the server for network workstations.

Windows 95 files are distributed in the following three forms for installation on computers that already have other operating systems in place:

- Windows 3.0 (or higher) upgrade on CD-ROM
- Windows 3.0 (or higher) upgrade on 3.5-inch high-density disks
- MS-DOS upgrade on 3.5-inch high-density disks

Depending on the license agreement at your site, you can also copy the Windows 95 source files to a shared network directory. Users can connect to this directory and run Windows 95 Setup.

You can also configure servers to support installing and running shared installations of Windows 95 in one of the following three ways:

- On a computer with a local hard disk, with system files stored on and running from the server
- On a computer with only a floppy disk drive, with system files stored on and running from the server
- From a Novell NetWare® server to support diskless workstations that remote boot from a startup disk image on the server

In these cases, most or all of the Windows 95 program files reside on the server instead of the workstation. For information, see [Server-Based Setup for Windows 95](#).

Deciding to Use Customized or Automated Setup

You can choose any combination of methods for configuring custom versions of Windows 95:

- Create custom setup scripts based on the MSBATCH.INF format. Custom setup scripts contain predefined settings for all Setup options, and they can contain instructions for installing additional software.
- Define WRKGRP.INI files to control users' choices for workgroups to join on the network.
- Enable user profiles and create system policies to specify and maintain the system configuration.

You can use setup scripts to create an automated mandatory installation scheme for installing Windows 95 on multiple computers from Windows 95 source files on servers. The following methods are possible:

- Use a login script to run Setup from a custom setup script, automatically installing Windows 95 when each user logs on.
- Use Microsoft Systems Management Server to run Windows 95 Setup with a custom setup script as a mandatory action.
- Use network management software from another vendor to install Windows 95 automatically based on custom setup scripts.

In this chapter, notations in the margin indicate the MSBATCH.INF section name and option that you can specify to customize a particular part of Setup in a script. For more information, [Custom, Automated, and Push Installations](#).







Deciding to Use Maintenance or Repair Setup

If Setup encounters an error or stops during hardware detection so that you have to run Windows 95 Setup again, the Safe Recovery option in Setup automatically skips previous problems so that Setup can be completed. You can also use Safe Recovery to repair damaged or corrupt installations. For more information, see [Beginning Windows 95 Setup and Safe Recovery](#) and [Setup Technical Discussion](#).

If you run Windows 95 Setup after the operating system is installed, Setup asks if you want to verify the existing installation. You can use this feature to verify or repair the files that make up the Windows 95 operating system. You might be able to restore damaged files without completely reinstalling Windows.

Also, you can create an emergency startup disk during Windows 95 Setup, which you can use to start the computer in case of configuration problems. For information, see [Creating a Startup Disk](#).

Windows 95 provides a variety of maintenance applications for adding, removing, and configuring Windows 95 components. Many of these applications are summarized in the following table.

Icon	Application	Description
	Add/Remove Programs	Installs or removes applications created for Windows 95; runs Windows 95 Setup to add or remove components; or creates a startup disk. To run this wizard, click the Add/Remove Programs icon in Control Panel.
	Add New Hardware	Installs hardware device drivers. To run this wizard, click the Add New Hardware icon in Control Panel.
	Display	Installs and configures display drivers. To run this option, click the Display icon in Control Panel.
	Printer	Installs and configures printers. To run this wizard, click the New Printer icon in the Printers folder.
	Modems	Installs and configures modems. To run this wizard, click the Modems icon in Control Panel.
	Network	Installs and configures network components. To run this option, click the Network icon in Control Panel.

Before Starting Windows 95 Setup

You should consider the following questions before proceeding with Windows 95 Setup on an individual computer:

Is the hardware supported?

Check the Windows 95 README file and SETUP.TXT on the installation disks for any notes related to your computer hardware. If any specific computer component is not supported, Windows 95 selects a generic driver or uses the existing driver installed on the computer. If you install support manually for a hardware component that doesn't appear in the installation dialog boxes, select the model that your hardware can emulate or that is of the closest type. (All supported hardware components are listed when you run the Add New Hardware wizard, as described in [Devices](#).)

Do the computer components meet the minimum requirements?

Read [Installation Requirements](#), and check your computer hardware and software components. Verify that all components meet the minimum requirements.

Are all unnecessary TSRs and time-out features disabled?

Disable all TSRs and device drivers loaded in CONFIG.SYS or AUTOEXEC.BAT (or in any batch files called from AUTOEXEC.BAT), except those required for partition or hard disk control, network drivers,

or any driver required for operation of a device such as video, CD-ROM, and so on.

Some portable computers (such as the IBM ThinkPad®) automatically suspend operation after a specified time-out interval, or when the cover is closed. You should disable this feature while Windows 95 Setup is running.

Is the installation drive checked and defragmented?

Windows 95 Setup automatically runs ScanDisk to check the integrity of the drive where Windows 95 is to be installed. However, you might want to check and defragment the hard disk drive thoroughly before beginning Setup, using your usual defragmentation software.

Also, be sure to defragment all compressed drives, because a highly fragmented compressed drive reports more available disk space than is available. If you use disk compression software other than DriveSpace or DoubleSpace, be sure to run the disk-checking utility provided with your compression software. For information, see the documentation provided with the compression software.

Tip When you run Windows 95 Setup, ScanDisk performs a quick check of the hard disk. You can skip this quick check (for example, if the computer uses disk compression software from another vendor) by using the */iq* or */is* switch with the **setup** command, as described in [Using Setup Command-Line Switches](#). If you choose to skip automatically running ScanDisk, be sure to use another utility to check the integrity of the hard disk before running Setup.

Are all key system files backed up?

Any time you upgrade an operating system, backing up critical business or personal data is a prudent precaution. The files you should back up before installing Windows 95 include the following:

- All initialization (.INI) files in the Windows directory
- All Registry data (.DAT) files in the Windows directory
- All password (.PWL) files in the Windows directory
- All Program Manager group (.GRP) files in the Windows directory
- All critical real-mode drivers specified in CONFIG.SYS and AUTOEXEC.BAT
- CONFIG.SYS and AUTOEXEC.BAT in the root directory
- Proprietary network configuration files and login scripts

Does the networking software work correctly?

Make sure that the network software is running correctly before you start Windows 95 Setup. Windows 95 uses the settings from the existing network configuration to set up the new configuration. Check the Windows 95 README file for additional notes related to your networking software.

Starting Windows 95 Setup

The Windows 95 Setup program (SETUP.EXE) is found on the Windows 95 installation disks, or it can be stored on a shared network resource. For information about the installation media, see [Options for Windows 95 Installations](#).

This section describes methods for starting Windows 95 Setup on computers that will run Windows 95 from the local hard disk after installation. For information about setting up a computer to run a shared copy of Windows 95, see [Server-Based Setup for Windows 95](#).

Caution Except for TSRs required for partition or hard disk control, network drivers, or device drivers such as CD-ROM, no TSRs or Windows-based applications should be running when you start Windows 95 Setup. Close any such applications before continuing with Setup.

To start Windows 95 Setup from Windows 3.1 or Windows for Workgroups

1. Start your computer in the usual way, and run Windows.
2. If you are installing Windows 95 from floppy disks, insert Disk 1 in the drive and make that the active drive in File Manager.
 - Or –
 - If you are installing Windows 95 from CD-ROM, put the compact disc in the drive and make that the active drive.
 - Or –
 - If you are installing Windows 95 from source files on a network server, connect to that server and switch to the shared network directory that contains the Windows 95 source files.
3. Double-click SETUP.EXE in the directory of the Windows 95 installation files.
 - Or –
 - From the File menu, choose Run, and then type **setup** and press ENTER.
4. Follow the instructions on-screen, as described in the following sections of this chapter.

To start Windows 95 Setup from MS-DOS

1. Start your computer in the usual way.
2. If you are installing Windows 95 from floppy disks, insert Disk 1 in the drive and make that the active drive. For example, type **a:** if the disk is in the A drive.
 - Or –
 - If you are installing Windows 95 from CD-ROM, put the compact disc in the drive and make that the active drive.
 - Or –
 - If you are installing Windows 95 from source files on a network server, connect to that server and switch to the shared network directory that contains the Windows 95 source files.
3. At the command prompt, type **setup**, and then press ENTER.
4. Follow the instructions on-screen, as described in the following sections of this chapter.

To start Windows 95 Setup from a network computer using a setup script

1. Log on to the network, running the existing network client.
2. Connect to the server that contains the Windows 95 distribution files.
3. At the command prompt, run Windows 95 Setup by specifying the batch file that contains the setup script, using this syntax:

setup *msbatch.inf*

For example, type **setup \\ntserver\win95\mybatch.inf** to run Setup using a setup script named MYBATCH.INF that is stored in the WIN95 directory on a server named NTSERVER. For more information, see [Custom, Automated, and Push Installations](#).

Note If Windows 95 is installed from a server, the location of that network directory is stored in

the Registry. When you add a device or require additional support files to run Windows 95, Setup automatically attempts to retrieve the files from that same location on the server. This eliminates the need to maintain a permanent network connection on the computer and makes it easier to modify the configuration of a computer in a networked environment.

Using Setup Command-Line Switches

Windows 95 Setup provides options to control the installation process. These options, or switches, are specified on the command line as arguments for the **setup** command (such as **setup /d**). Similar to MS-DOS command arguments, the specific option is preceded by a forward slash (/) character (not the backslash used to specify directory arguments).

Windows 95 Setup can be run with the **setup** command with the following switches.

Switch	Meaning
/?	Provides help for syntax and use of setup command-line switches.
/C	Instructs Windows 95 Setup not to load the SmartDrive disk cache.
/d	Instructs Windows 95 Setup not to use the existing version of Windows for the early phases of Setup. Use this switch if you have problems starting Setup that might be due to missing or damaged supporting files for Windows.
/id	Instructs Windows 95 Setup not to check for the minimum disk space required to install Windows 95.
/ih	Runs ScanDisk in the foreground so that you can see the results. Use this switch if the system stalls during the ScanDisk check or if an error results.
/iL	Loads the Logitech mouse driver. Use this option if you have a Logitech Series C mouse.
/iq	Instructs Windows 95 Setup not to perform the ScanDisk quick check when running Setup from MS-DOS. You probably want to use this switch if you use compression software other than DriveSpace or DoubleSpace.
/is	Instructs Windows 95 Setup not to run the ScanDisk quick check when starting Setup from Windows. You probably want to use this switch if you use compression software other than DriveSpace or DoubleSpace.
/nostart	Instructs Windows 95 Setup to copy a minimal installation of the required Windows 3.x DLLs used by Windows 95 Setup, and then to exit to MS-DOS without installing Windows 95.
script_filename	Instructs Windows 95 Setup to use settings in the specified script to install Windows 95 automatically; for example, setup msbatch.inf specifies that Setup should use the settings in MSBATCH.INF. For more information, see <u>Custom, Automated, and Push Installations</u> .
/t:tempdir	Specifies the directory where Setup is to copy its temporary files. This directory must already exist, but any existing files in the directory will be deleted.

Tip for Accessibility Needs and Windows 95 Setup

Users who require accessibility aids with Windows might find it difficult to install Windows 95 in the usual way because accessibility aids cannot run with Windows 95 Setup.

To solve this problem, users (or their system administrator) can provide setup answers in a setup script, which is a text file that is created before running Setup. Then the user can run Setup from the command prompt

using this setup script. Windows 95 Setup will run without requiring additional user input. For more information, see [Custom, Automated, and Push Installations](#).

Introduction to Windows 95 Setup

Starting Windows 95 Setup

Beginning Windows 95 Setup and Safe Recovery

As soon as you start Windows 95 Setup, the screen indicates that Setup is being initialized. During this earliest phase, several files needed to run Setup are copied to the local computer, and Setup runs ScanDisk to check the integrity of the hard disk. After Windows 95 Setup completes these activities, the Welcome message shows the estimated time that it will take to complete the process, plus the basic phases of Windows 95 installation.

MSBATCH.INF
[setup]
express=1
bypasses this screen



▶ To navigate in Windows 95 Setup

- Click the Next or Back buttons on the Setup screens to navigate through choosing installation options.

Click the Next button to accept the choices you made on the current screen and to continue to the next screen; click the Back button to return to the previous screen to make changes.

If a previous attempt to install Windows 95 has failed, Windows 95 Setup provides an option to use the Safe Recovery feature or to run a full new Setup process. If the Safe Recovery dialog box appears when you start Windows 95 Setup, you should select the Use Safe Recovery option. When you select this option, Windows 95 Setup can use built-in methods to avoid problems that occurred previously.

After you start Safe Recovery, the standard Windows 95 Setup wizard screen appears. For more information about Safe Recovery, see [Setup Technical Discussion](#).

MSBATCH.INF

[setup]
express=1
bypasses this screen



Technical Note on ScanDisk for Windows 95 Setup

When you run Windows 95 Setup from MS-DOS (rather than Windows), ScanDisk runs in interactive mode. If you choose not to fix errors that ScanDisk finds or if you try to exit before ScanDisk is finished, Setup will not continue. By default, ScanDisk checks all drives, except the A drive if you run Setup from floppy disks.

When you run Windows 95 Setup from Windows 3.x or Windows for Workgroups, Setup runs ScanDisk in a non-interactive mode. If ScanDisk finds errors, Setup asks you to exit Windows and run ScanDisk as a standalone program. If ScanDisk finds only long filenames, Setup allows you to continue. Lost clusters are not detected, nor are mismatched FAT file systems or certain other file system problems.

When you run Windows 95 Setup on a computer with MS-DOS DoubleSpace or DriveSpace compressed drives, ScanDisk treats these as regular compressed volumes and also checks your host volumes. If SSTOR (or any other compression software from another vendor) is in memory, then ScanDisk acts as if it doesn't see any compressed drives and treat all drives as normal FAT drives.

Introduction to Windows 95 Setup

Running Windows 95 Setup

This section describes the procedures for installing Windows 95 on the hard disk of a computer that is not running a shared copy from a network server. The following series of tasks are described:

- Gathering information
- Analyzing the computer (hardware detection)

- Selecting software components in Custom Setup
- Selecting network components in Custom Setup
- Specifying computer identification
- Changing computer settings in Custom Setup
- Creating a startup disk
- Copying files and completing Setup

Introduction to Windows 95 Setup

Running Windows 95 Setup

Gathering Information

Most information needed to install Windows 95 is gathered automatically by Windows 95 Setup before you are asked to do anything. The following series of tasks are presented by Windows 95 Setup to guide you through providing the information needed to install and configure the new operating system:

- Choosing the Windows directory
- Selecting the setup type
- Checking disk space for Windows 95

Introduction to Windows 95 Setup

Running Windows 95 Setup

Gathering Information

Choosing the Windows Directory

This option is available for all setup types

If a previous installation of Windows 3.1 or Windows for Workgroups 3.x exists, Windows 95 asks you to confirm the directory where Windows 95 is to be installed. By default, the directory containing the existing Windows installation is selected.

For information about deciding whether to install Windows 95 in a new directory, see [Deciding to Run Setup from MS-DOS or Windows.](#)

To install Windows 95 in a new directory

1. Click the Other Directory option, and then click the Next button.

MSBATCH.INF

[setup]

InstallDir=*dirname*

sets this value and bypasses confirmation



2. Type a new directory name, and then click the Next button.

MSBATCH.INF

[setup]

InstallDir=*dirname*

bypasses this screen



If you choose to install Windows 95 in a new directory, you might need to reinstall Windows-based applications because Windows 95 uses a different method from Windows 3.x for storing configuration information, and because application support files such as DLLs will be missing from the Windows 95 directory. Windows 95 Setup cannot transfer this information automatically.

Note You cannot migrate system settings and groups under Windows 3.1 and Windows for Workgroups 3.x by copying all the .GRP and .INI files into the new installation directory. This does not work with Windows 95, because .GRP files and .INI file entries cannot be used by Windows 95 unless Windows 95 Setup migrates this information to the Registry. You must run Windows 95 Setup and install Windows 95 in the existing Windows directory to migrate .GRP and .INI file information from Windows 3.x.

Introduction to Windows 95 Setup

Running Windows 95 Setup

Gathering Information

Selecting the Type of Setup

Windows 95 Setup asks you to select the type of setup you want. For a description of these options, see [Deciding to Use Typical, Portable, Compact, or Custom Setup](#). By default, the Typical Setup option is selected.

MSBATCH.INF

[setup]

express=1

bypasses this screen;

InstallType=0, 1, 2,

or 3 selects Compact, Typical, Portable, or Custom, respectively

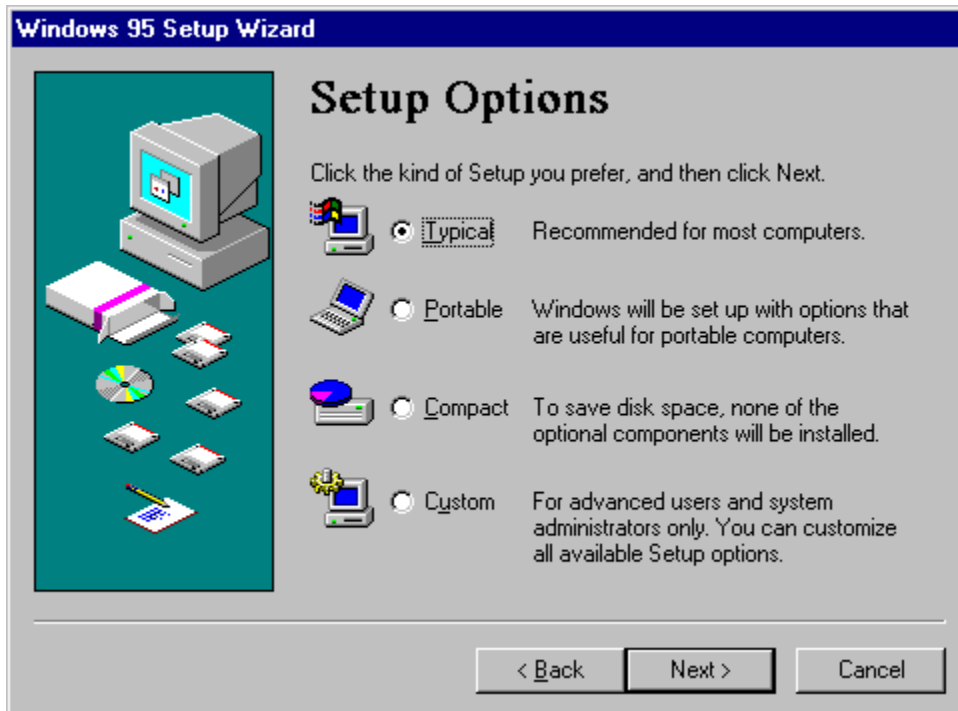

To specify Custom Setup

- In the Setup Options screen, click Custom, and then click the Next button.

Introduction to Windows 95 Setup

Running Windows 95 Setup

Gathering Information

Checking Disk Space for Windows 95

After you select the directory for Windows 95, Setup checks the hard disk, prepares the directory, and verifies that there is enough free disk space for Windows 95. If there is insufficient space on the destination drive, Windows 95 Setup warns you about the lack of space, and displays the minimum and complete installation space requirements.

If Windows 95 Setup detects that there is insufficient disk space for a normal upgrade of an existing version of Windows, you can choose to install a compact configuration of Windows 95. If you continue even though there is insufficient disk space, the installation might be incomplete. If Setup runs out of disk space, it stops and displays an error message; you must free additional disk space and then run Setup again.

Introduction to Windows 95 Setup

Running Windows 95 Setup

Gathering Information

Providing User Information

This option is available for all setup types

The information requested during this part of Setup is required, no matter what setup type you specified.

After completing the disk-space check, Windows 95 Setup asks you to type your name and company name, which Windows 95 uses to identify you for various operations. You must type and verify a response for Setup to continue.

MSBATCH.INF

[NameAndOrg]

name=*value*

org=*company*

sets these values;

display=0

bypasses displaying this screen



Windows 95 Setup next requests a product identification number. You must type and verify a response for Setup to continue. The Product ID dialog box might not appear if you are installing Windows 95 from the network, depending on the requirements at your site. The product ID number can be found on your Windows 95 disks or your Certificate of Authenticity.

Introduction to Windows 95 Setup

Running Windows 95 Setup

Analyzing the Computer

This option is available for all setup types

After you complete the user information, Windows 95 Setup prepares for the hardware detection phase. Setup can search automatically for all basic system components such as disk drives and controllers, display devices, pointing devices, and keyboards.

For Typical Setup, you can choose to skip detection for certain hardware, such as CD-ROM or multimedia devices, depending on what Setup finds during its safe-detection examination of the hardware. If Setup proposes to skip detection of certain hardware, but you know that these types of devices are attached to the computer, you can override the suggestion and have Setup detect the devices. Otherwise, skipping detection for the devices as suggested by Setup saves time during installation.

For Custom Setup, you can specify whether you want Setup to skip detecting any specific devices attached to your computer. Usually, you should let Setup detect the hardware unless you know that the computer contains devices that cause problems during hardware detection. For example, you should skip detection of a particular device if Setup failed previously while detecting that device and if Safe Recovery does not automatically skip detecting that device when you run Setup again.

For information about specific device types supported in Windows 95, see the Manufacturers and Models lists in the Add New Hardware wizard, and see the Windows 95 README.TXT and SETUP.TXT files.

MSBATCH.INF
express=1
bypasses this
screen

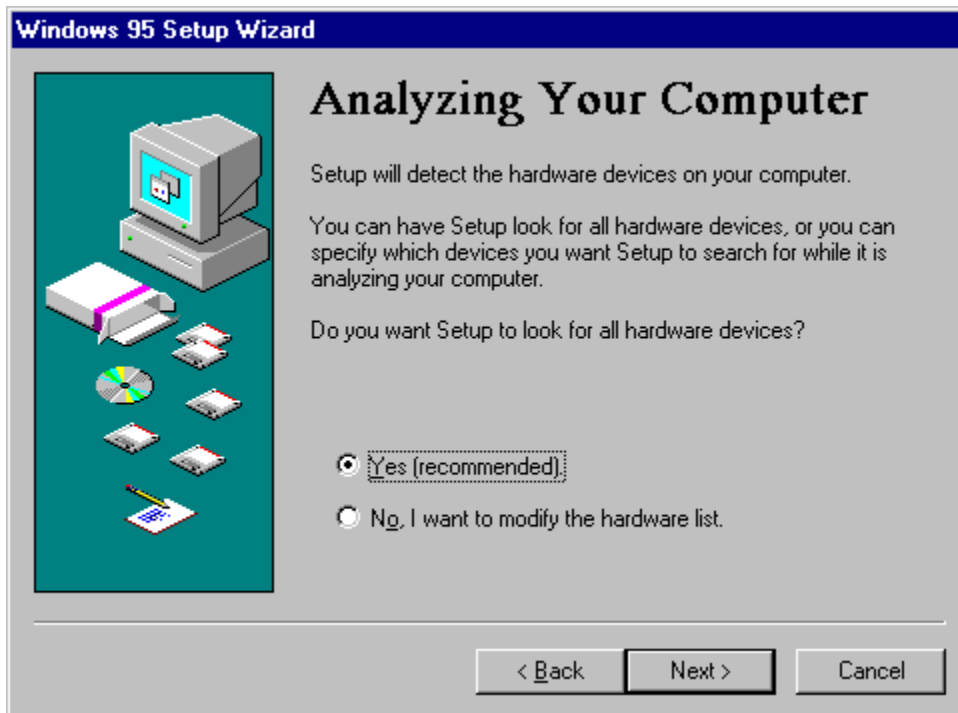

- ▶ **To have Windows 95 Setup attempt to detect all system hardware**
- On the first Analyzing Your Computer screen, click the Yes option, and then click the Next button.

▶

To modify the list of hardware to be detected in Custom Setup

1. On the first Analyzing Your Computer screen, click the option named No, I Want To Modify The Hardware List, and then click the Next button.

The second Analyzing Your Computer screen appears, containing lists of the components that Windows 95 Setup proposes to detect.

2. To avoid detecting a specific class of hardware, make sure the hardware class is not checked in the Hardware Types list.

-Or-

To avoid detecting a specific manufacturer and model of a hardware device (while detecting other devices in that class), make sure the related hardware type is checked, and then make sure the item you want to skip in the Manufacturer And Model list is not checked.

If a Hardware Type is dimmed (but not checked), then you cannot change how Windows 95 Setup detects that class of hardware.

Note The list of CD-ROM drives shows only proprietary drives that require special installation consideration. All other CD-ROM drives are detected automatically.

3. To begin hardware detection, click the Next button, and then click it again.

MSBATCH.INF

does not allow you to skip parts of detection

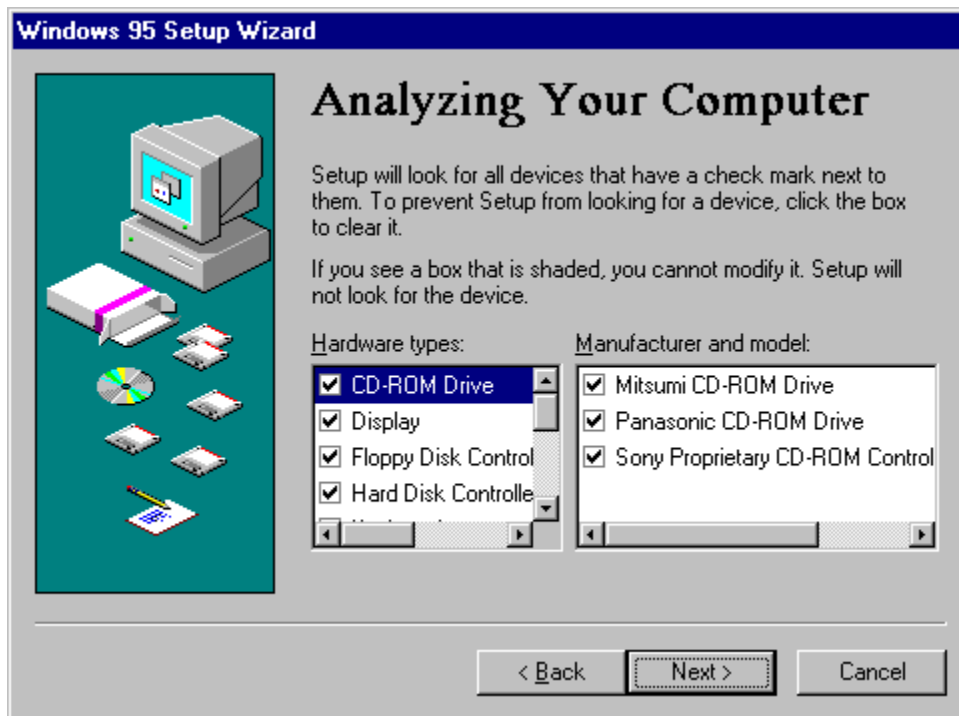

The hardware detection process can take several minutes. The progress indicator shows what portion of hardware detection has been completed. Notice that this is also the point at which Windows 95 Setup can stall if hardware detection fails for a particular system component.

To continue if Windows 95 Setup stops during hardware detection

1. Press F3 or click the Cancel button to quit Setup.

If the computer does not respond to the Cancel button, restart the computer by turning it off and then back on again.

2. Run Setup again.

Setup prompts you to use Safe Recovery to recover the failed installation.

3. Click Use Safe Recovery, and then click the Next button.

4. Repeat your installation choices.
Hardware detection runs again, but Setup skips the portion that caused the initial failure.
5. If the computer stops again during the hardware detection process, repeat this procedure until the hardware detection portion of Setup completes successfully.

Introduction to Windows 95 Setup

Running Windows 95 Setup

Selecting Software Components

If you are running Typical Setup, the following screen appears so that you can specify whether you want to choose the accessories and other software to be installed with Windows 95:

This screen appears for Typical Setup

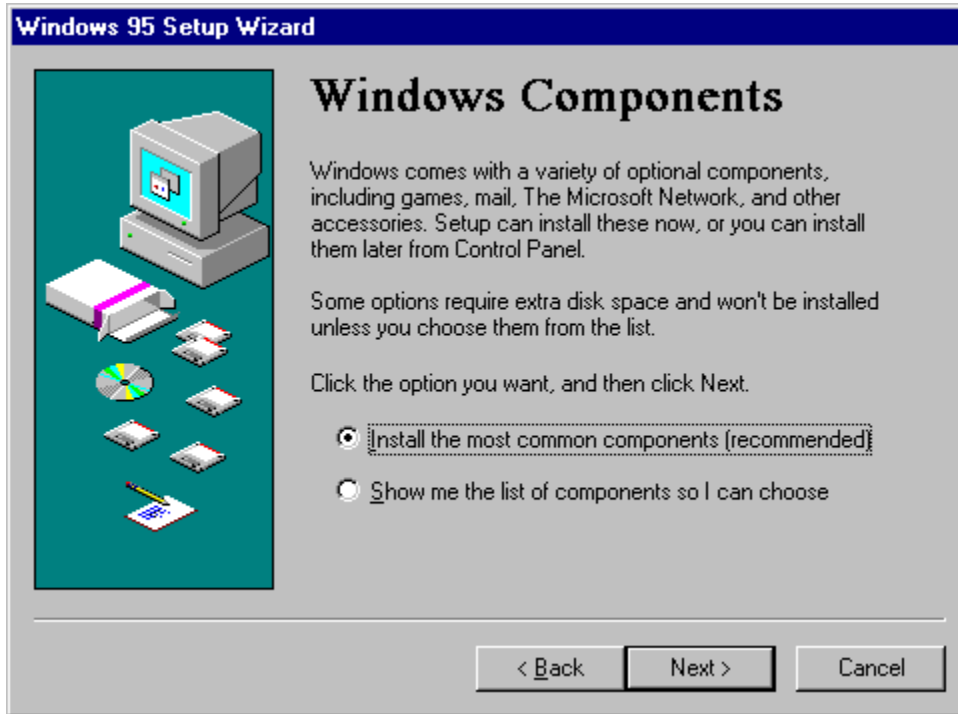

If you choose the option for customizing the list of components to be installed, the Select Components dialog box appears. (For Custom Setup, the Select Components screen appears automatically.) Notice that the Components list includes information about the disk space required for that component.

MSBATCH.INF

[OptionalComponents] can define the components to be installed

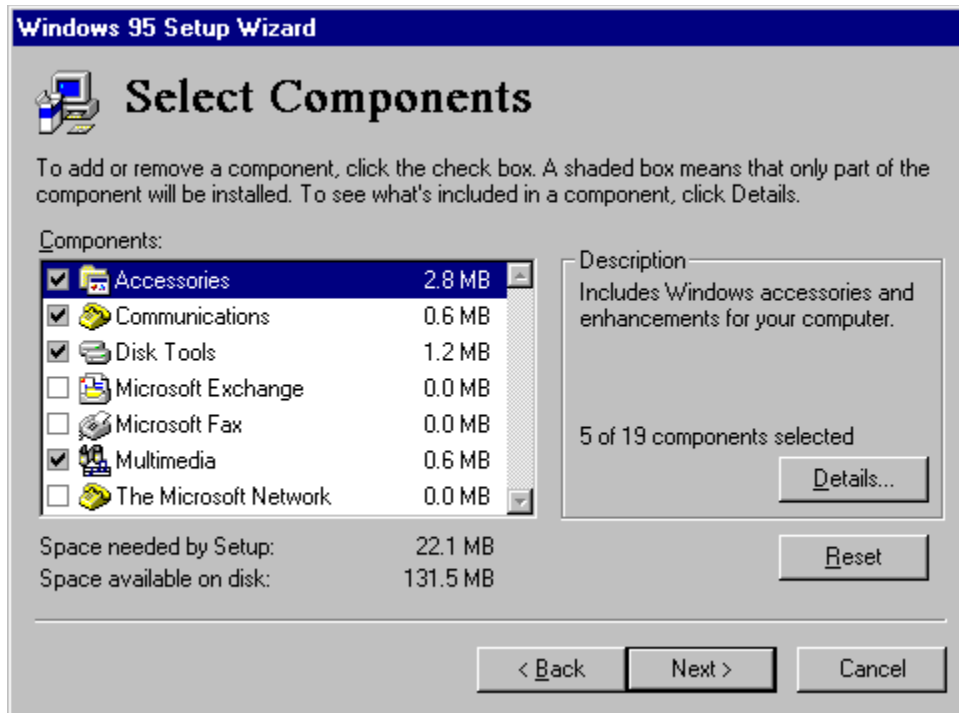

To change whether any component is installed

1. In the Components list, select a component category, and then click the Details button.
 - A dialog box appears, listing the components in the category.
2. Select the component you want to install, and then click OK.
 - To add a component, make sure the component is checked.
 - To prevent a component from being installed, make sure the component is not checked.

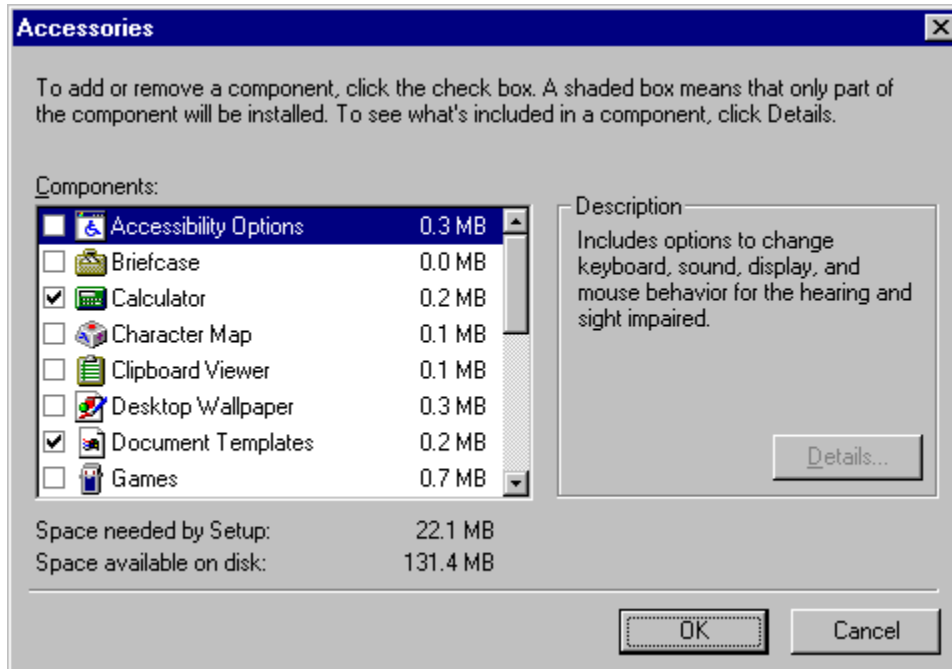

3. Repeat this procedure for each category in the Components list on the Select Component screen.

4. When you are satisfied with your selections, click the Next button.

Note You can install or remove any of these components after Windows 95 is installed by using the Add/Remove Programs option in Control Panel, as described in [Application Support](#).

Selecting Network Components in Custom Setup

This option is available only for Custom Setup

Windows 95 Setup allows you to specify network components and settings. This section summarizes the options for modifying network settings during setup. For information about network support, see [Introduction to Windows 95 Networking](#).

Note Windows 95 Setup provides appropriate settings based on hardware and software detection for the network components running when you start Setup. You should accept the default settings unless you know that particular settings need to be changed.

To remove a network component from the list of components to be installed

- In the Network Configuration screen, select the component you do not want to install, and then click the Remove button.

MSBATCH.INF

[setup]

network=0

bypasses installing networking components;

[network] settings can define networking components to be installed;

display=0

bypasses

this screen

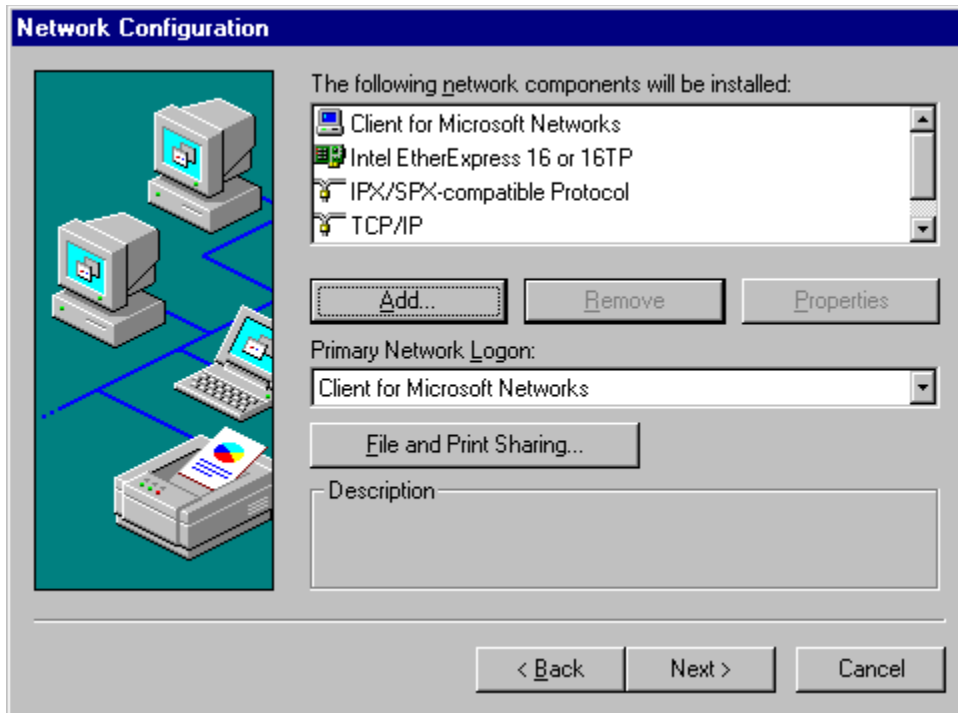

To add a network component to the list of components to be installed

1. In the Network Configuration screen, click the Add button.
2. In the Select Network Component Type dialog box, select the type of component you want to add, and then click the Add button.

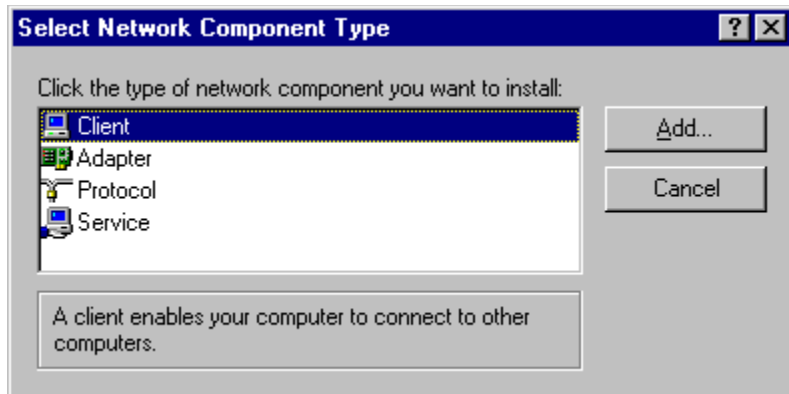

Note If you are installing a real-mode (16-bit) network client from another vendor, the Adapter, Protocol, and Service component types are not available.

3. In the dialog box for the selected component type, select the manufacturer of the component in the Manufacturers list, and then click the appropriate version in the list of models. Click OK.
4. To configure settings for the component you just added, click the component, and then click the Properties button.

Important If your computer is connected to a Windows NT domain, be sure to configure Client for Microsoft Networks to specify the correct domain for logon validation. This ensures that you can log on to your preferred domain and your network printer selections are available automatically.

If you do not specify a domain name when you are installing Windows 95 from source files on the network, Setup might not be able to access required files for completing the final stages of installation.

The following sections summarize each type of network option.

Introduction to Windows 95 Setup

Running Windows 95 Setup

Selecting Network Components in Custom Setup

Selecting the Network Client

If you choose to add a network client, Windows 95 Setup displays a list of supported networks. Windows 95 supports the following network types, although in most cases you also need to use supporting software from the network vendor:

- Microsoft networks, such as Windows NT, Windows for Workgroups, LAN Manager 2.x, or LAN Manager-compatible networks such as IBM LAN Server, or DEC™ PATHWORKS™
- Artisoft® LANtastic® version 5.0 and later
- Banyan® VINES® version 5.52 and later
- Novell NetWare version 3.11 and later
- SunSoft™ PC-NFS® version 5.0 and later

Note Artisoft LANtastic cannot be used with a 32-bit, protected-mode networking client such as Client for Microsoft Networks. This client must be installed as the sole network client on the computer.

MSBATCH.INF

[network]

clients=*value*

defines this option, where the value is a device ID defined in NETCLI.INF or NETCLI3.INF

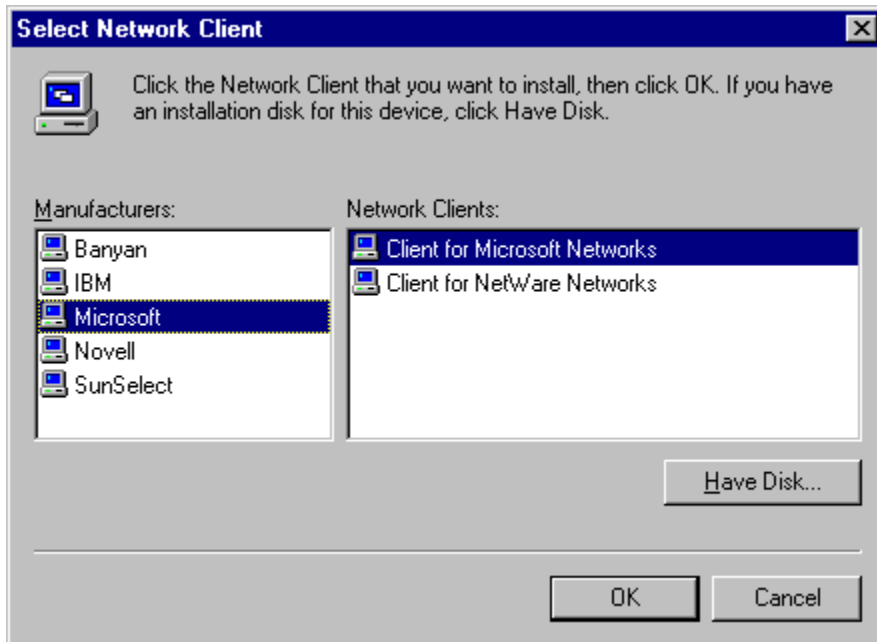

To use Microsoft networking features, you must install Client for Microsoft Networks. For information about configuring this client, see [Windows 95 on Microsoft Networks](#). For information about installing and configuring network clients for other kinds of networks, see [Windows 95 on Other Networks](#).

To use Windows 95 on a NetWare network, you must install supporting client software, as described in [Windows 95 on NetWare Networks](#). If you let Setup automatically install the Microsoft 32-bit, protected-mode Client for NetWare Networks, you can take advantage of automatic reconnection to servers and client-side caching for network information, in addition to the improved performance of the protected-mode networking components.

Introduction to Windows 95 Setup

Running Windows 95 Setup

Selecting Network Components in Custom Setup

Selecting and Configuring a Network Adapter

Windows 95 supports multiple network adapters (also called network interface cards, or NICs) in a manner similar to Windows for Workgroups 3.11 — that is, up to four network adapters can be supported in a single computer.

Network detection automatically determines the type of network adapter and its required resource settings. This is always the recommended method for configuring network adapters.

If you choose to add a network adapter, Windows 95 displays a list of supported network adapters. For information about technical issues for network adapters, see [Network Technical Discussion](#).

MSBATCH.INF

[network]

netcards=*value*

defines this option, where the value is a device ID defined in the related INF file

In most cases, network detection is the best method for installing network adapters

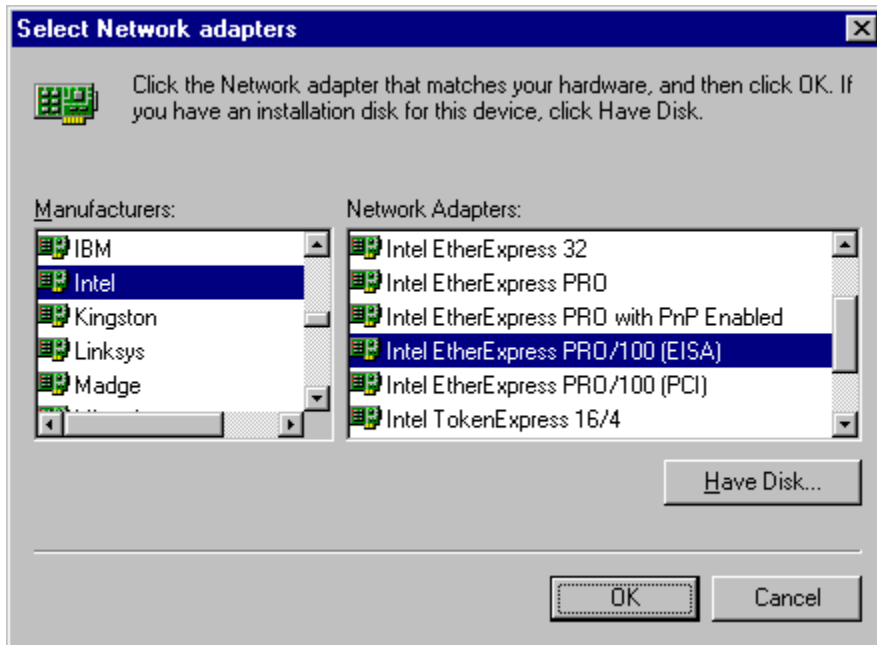

Introduction to Windows 95 Setup

Running Windows 95 Setup

Selecting Network Components in Custom Setup

Selecting and Configuring the Network Protocols

Windows 95 Setup automatically installs the appropriate protocol for the network client you select. Microsoft provides 32-bit, protected-mode versions of these protocols:

- IPX/SPX-compatible protocol
- Microsoft NetBEUI
- Microsoft TCP/IP

Protocols to support other network clients are also provided with Windows 95. For information about the three principal network protocols, see [Network Technical Discussion](#).

MSBATCH.INF

[network]

protocols=*value*

defines this option, where the value is a device ID defined in NETTRANS.INF

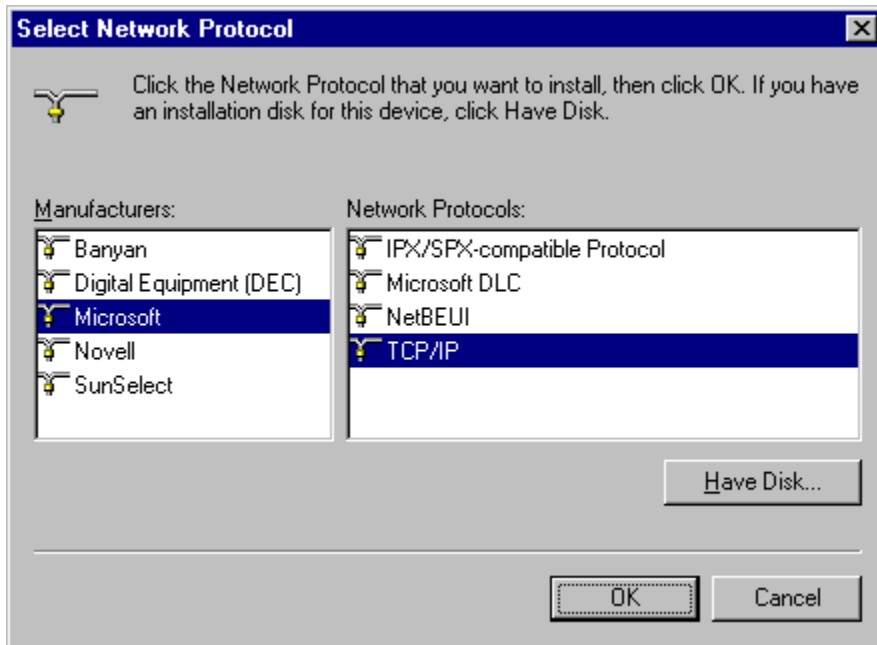

Introduction to Windows 95 Setup

Running Windows 95 Setup

Selecting Network Components in Custom Setup

Selecting and Configuring a Network Service

Network services provide additional networking support. Microsoft provides several supporting network services for Windows 95. Services included on the Windows 95 installation disks include peer resource sharing services (File and Printer Sharing for NetWare Networks or File and Printer Sharing for Microsoft Networks). These services allow other computers on the network to share file, printer, and CD-ROM resources on this computer. For more information about installing, configuring, and using these services, see [Logon, Browsing, and Resource Sharing](#).

MSBATCH.INF

[network]

services=*value*

defines this option, where the value is a device ID defined in the related INF file

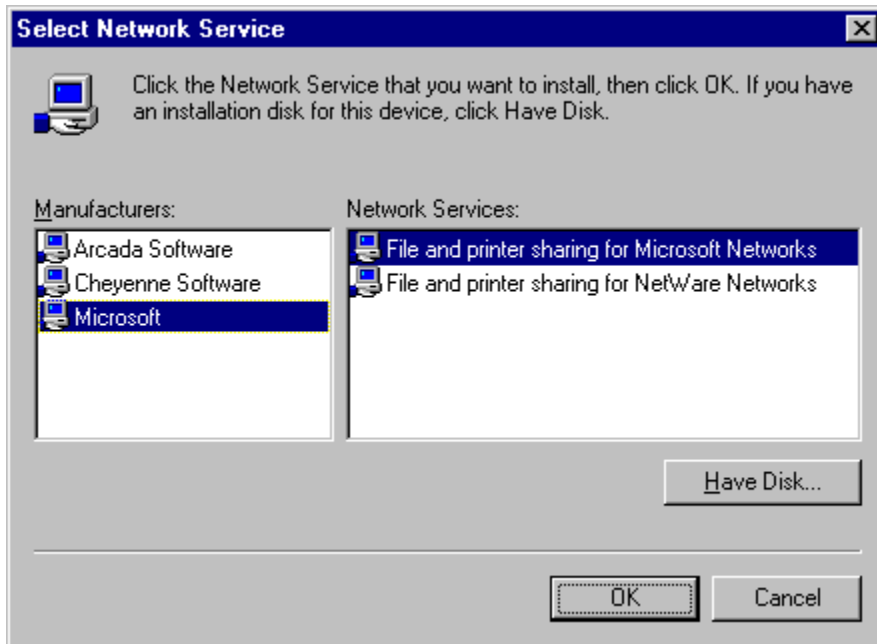

Additional network services, such as backup agents, a Simple Network Management Protocol (SNMP) agent, the Microsoft Remote Registry agent, are also provided on the Windows 95 compact disc in the ADMIN directory, as described in [Remote Administration](#).

Specifying Computer Identification

The Identification screen allows you to specify how the computer is identified on the network. This option is available for all setup option types on networked computers.

```
MSBATCH.INF
[network]
computername=value
workgroup=value
description=value
define these options
```

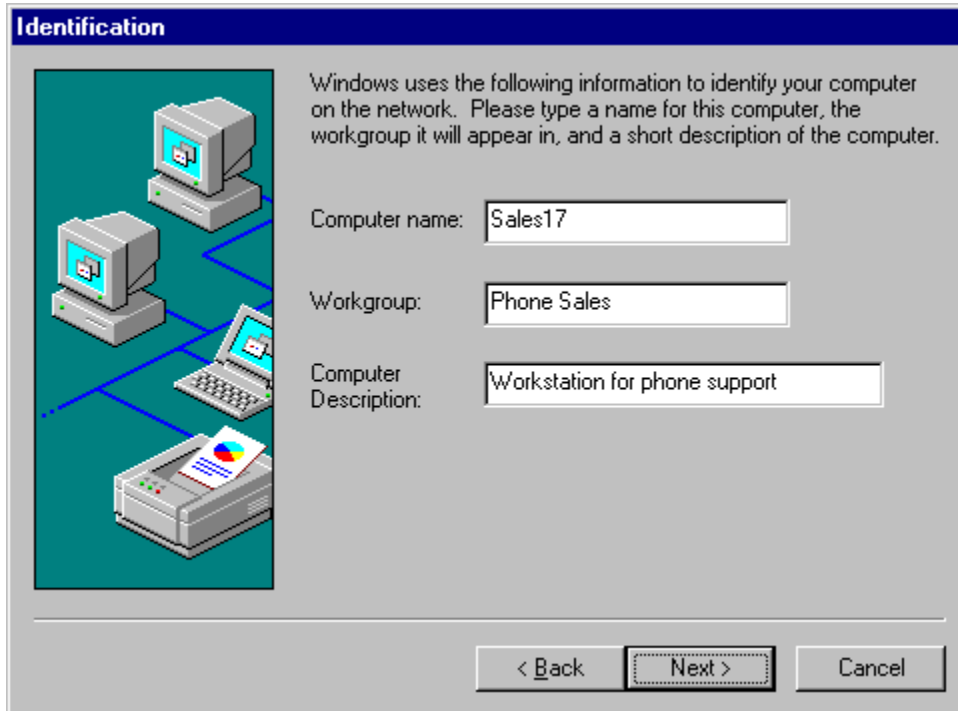

- The computer name must be unique on the network, and can be up to 15 characters long with no spaces (no blank characters). The name can contain only alphanumeric characters and the following special characters:
! @ # \$ % ^ & () - _ ' { } . ~
- The workgroup name can be up to 15 characters long and uses the same naming convention as the computer name. The workgroup is used to associate groups of computers together for more efficient browsing. The network administrator can provide guidelines for workgroup selection by using WRKGRP.INI, as described in Custom, Automated, and Push Installations.
- The computer description can be up to 48 characters long, but it cannot contain any commas (.). This text appears as a comment next to the computer name when users are browsing the network, so you can use it to describe the department or location of the computer, or the type of shared information.

Changing Computer Settings in Custom Setup

This option is available only for Custom Setup

Windows 95 Setup detects the hardware in the computer and determines appropriate default values for configuring the hardware. Usually, you should accept the values determined through hardware detection, unless you know that a manual setting must be supplied.

Note You can select options in the Computer Settings screen for Advanced Power Management (an option on some portable computers), Regional Settings (the local language preference), and Windows User Interface (Windows 95 versus Program Manager). You can also add multilanguage support for Eastern European, Greek, or Cyrillic languages if you are installing an English or Western European version of Windows 95.



To configure system hardware options

1. In the Computer Settings screen, click the item in the list you want to change, and then click the Change button.

```
MSBATCH.INF
[system] entries
define these options;
display=0
bypasses this screen
```

```
[setup]
express=1 also bypasses this screen
```



The Select Device dialog box appears. A list displays the models that are identified as compatible for the hardware detected in your computer.

```
MSBATCH.INF
[system]
display=value
```

defines this option; the value is a section name in that device's INF file

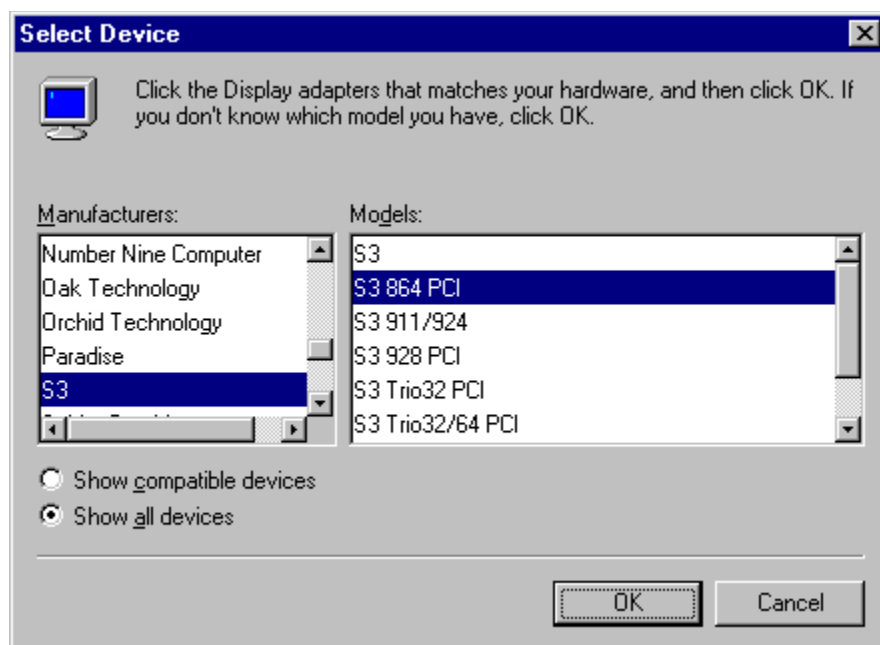

2. In the Select Device dialog box, select the model name that matches your device.

– Or –

If you want to display all possible entries for the selected device category, click the Show All Devices option, and then select the model that matches your device.

3. Click OK. For information about configuring a device, see [Devices](#).

The following chapters provide information about changing specific hardware settings. You use the same procedures during Custom Setup to change settings as are used after Windows 95 is installed.

To change this device setting **See this chapter**

Display, mouse, and COM ports [Devices](#)

Network adapter [Network Technical Discussion](#)

Keyboard [International Windows 95](#)

If Windows 95 does not have a new driver for your display adapter when upgrading over a previous version of Windows, it reports it as Standard Display Adapter (VGA) in the Computer Settings list. Later, Windows 95 displays a message stating that your display driver is invalid; however, you can select your Windows 3.1 driver from the list and continue. Although you can install Windows 3.1 display drivers, Microsoft recommends that you upgrade to Windows 95 drivers wherever possible for improved performance and reliability. For information, see [Devices](#).

Introduction to Windows 95 Setup

Running Windows 95 Setup

Creating a Startup Disk

This option is available for all setup types

In the Startup Disk screen, Windows 95 Setup offers to create an emergency startup disk that contains basic system files. You can use this disk to start Windows 95 when you cannot start the operating system from the hard disk. Creating the startup disk is the default option, but you can choose to bypass this step.

Important It is strongly recommended that you create a startup disk during Windows 95 Setup. If you want to create a startup disk later, you can use the Add/Remove Programs option in Control Panel to create one.

MSBATCH.INF

[setup]

EBD=1

forces creation of a startup disk



To create a startup disk

- Click the option named Yes, I Want A Startup Disk, and then click the Next button.

Introduction to Windows 95 Setup

Running Windows 95 Setup

Copying Files and Completing Setup

After hardware detection is complete and Windows 95 Setup has obtained all required information, the next phase of Windows 95 Setup begins. During this phase, the Windows 95 files are copied to the destination drive and directory.

MSBATCH.INF

[setup]

express=1

bypasses this screen



If you chose to have Windows 95 Setup create a startup disk, Setup asks you to insert a floppy disk into drive A. The disk does not need to be formatted or empty, but any information you have stored on the disk will be permanently deleted. After you insert the disk, click OK to create the startup disk. Windows 95 Setup formats the disk and copies the appropriate files.

When the basic installation steps are completed, Windows 95 Setup asks you to remove any disks from the floppy disk drives. After you click OK, the computer is restarted, and the final phase of the installation process begins, which includes converting Windows Program Manager groups and migrating various system configuration settings to the Registry.

Near the end of the installation process, Windows 95 Setup asks you to complete several configuration options. These configuration options are referred to as Run-Once options, because after you have completed the installation steps for these options, that particular set of activities is not repeated again when you choose the related option in Control Panel. Some Run-Once installation procedures are described in the following sections.

For more information about this phase, see [Setup Technical Discussion](#).

Introduction to Windows 95 Setup

Running Windows 95 Setup

Copying Files and Completing Setup

Setting the Local Time Zone

Setup prompts you to set the time zone for your location. This is an important step for network computers that need to keep time stamps synchronized.



To configure the local time zone

- Click your location on the map.
 - Or –
 - Select your time zone from the list.

MSBATCH.INF

[install]

timezone=*string*

defines this option

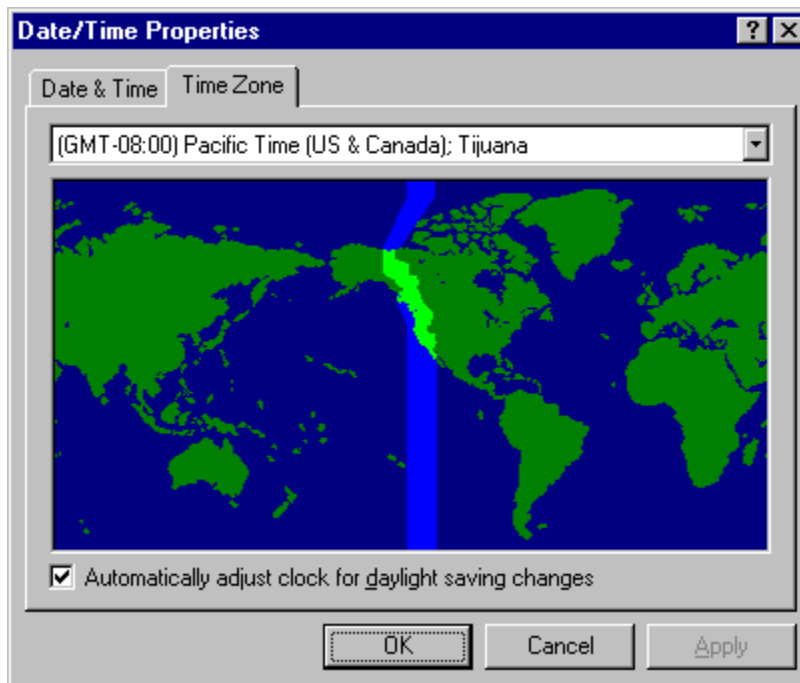

Introduction to Windows 95 Setup
Running Windows 95 Setup
Copying Files and Completing Setup

Installing and Configuring a Printer

If you are installing Windows 95 in a new directory or on a computer that did not have a previous version of Windows, Windows 95 Setup automatically runs the Add Printer wizard the first time that Windows 95 is started after the basic installation is complete.

MSBATCH.INF
[Printers]

printer=driver,port
defines this option

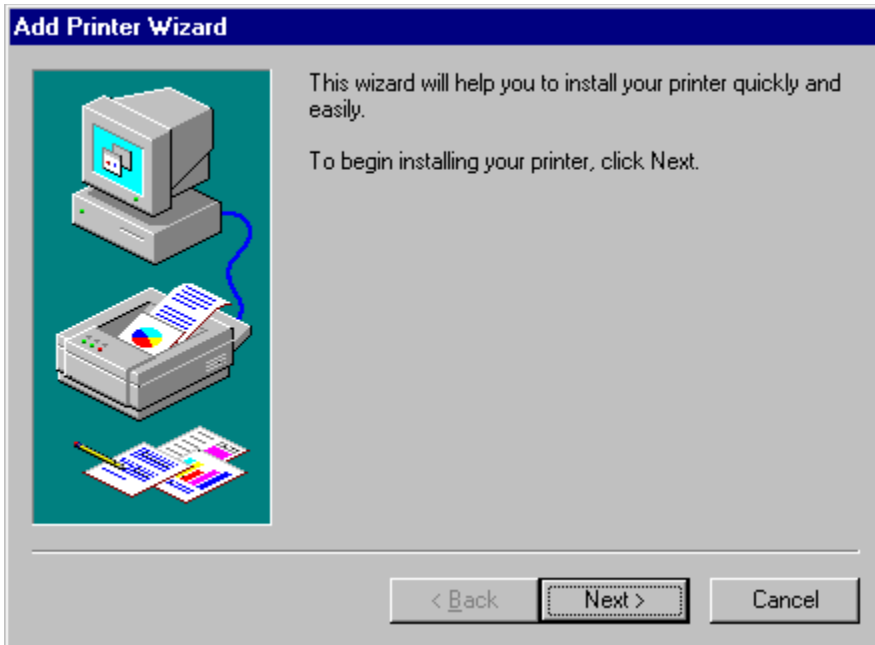

To configure a printer during Windows 95 Setup

- In the Add Printers wizard, click Next and follow the instructions on the screen.
 - Or –
 - Click Cancel if you do not want to install a printer.

If you want to install or change a printer after Windows 95 is installed, double-click the Printers folder in My Computer. For information about installing and managing printers in Windows 95, see [Printing and Fonts](#).

If you are installing Windows 95 in the same directory as an earlier version of Windows, then your previous printer configuration is incorporated into Windows 95 and the wizard for installing printers does not run during Setup.

Introduction to Windows 95 Setup

Running Windows 95 Setup

Copying Files and Completing Setup

Configuring Microsoft Exchange

During the final stages of Windows 95 Setup, the Inbox Setup wizard runs automatically if you selected Microsoft Exchange in the Select Components screen.

If the administrator has already created a postoffice, added users to it, and shared it with all users on the network, the postoffice name and location appear in the dialog box automatically without requiring you to type this information. This makes setting up the Microsoft Exchange client with the Microsoft Mail workgroup postoffice easy for all users in the workgroup. For information about setting up a Microsoft Mail workgroup postoffice, see [Electronic Mail and Microsoft Exchange](#).



To configure the Microsoft Exchange client

1. When the Inbox Setup wizard appears, follow the instructions on the screen for configuring the Microsoft Exchange client on your computer.
2. If you also selected Microsoft Mail Services in addition to Microsoft Exchange, the wizard prompts you for the path name for the postoffice location, your Microsoft Mail user name, and Microsoft Mail password.

Introduction to Windows 95 Setup

Running Windows 95 Setup

Copying Files and Completing Setup

Completing Windows 95 Setup

Depending on the options you selected during Setup, the hardware devices you have, or the computer you have, additional Run-Once options might need to be completed, such as the wizard for configuring MIDI devices. After all the Run-Once options are completed, all of the files are installed, and the computer is configured to run your applications.

For technical information about initializing the operating system at the completion of Setup and for a detailed description of the system startup process, see [Setup Technical Discussion](#).

Introduction

This chapter provides information about the Server-based Setup program, which is used to install Windows 95 source files on a server, and to prepare for installing Windows 95 to run as a shared copy on client computers.

- Server-Based Setup: The Basics
- Server-Based Setup: The Issues
 - Planning for Machine Directories
 - Planning for Shared Installations
- Server-Based Setup: An Overview
- Task 1: Copying Windows 95 Files to a Server
 - Selecting the Server
 - Setting the Destination Path and Installation Policy
 - Creating a Default Setup Script
 - Installing Files on the Server
- Task 2: Creating Machine Directories
- Installing Windows 95 for Shared Installations
- Configuring Shared Installations
 - Configuring Shared Installations for Protected-Mode Clients
 - Configuring Shared Installations for Real-Mode Clients
 - Creating the Disk Image for RIPL
- Technical Notes for Shared Installations
 - System Startup and Networking for Shared Installations
 - Technical Notes on MACHINES.INI and SETMDIR
 - Other Notes on Shared Installations

Server-Based Setup: The Basics

Server-based Setup (NETSETUP.EXE) is used to prepare the server to run Windows 95 Setup (SETUP.EXE) on network client computers. Windows 95 provides improved support over Windows 3.x for installing and running a shared copy of Windows 95 (that is, “shared installations”). After installing Windows 95 source files on a server, Server-based Setup can be used to create and manage machine directories, which contain the specific configuration information for each computer on a shared installation. You can also use Server-based Setup to create setup scripts (which are batch files for automated setup), as described in Custom, Automated, and Push Installations. Windows 95 supports the following kinds of shared installations:

- Computers that start from the local hard disk and then run a shared copy of Windows 95 from the server.
- Computers that start locally from a floppy disk and then run a shared copy of Windows 95 from the server.
- Diskless workstations that remote boot (sometimes called RIPL or remote IPL) from servers and run a shared copy of Windows 95.

At the time of the release of Windows 95, the remote-boot option can be used only for diskless workstations on Novell® NetWare® version 3.x and 4.0 networks. Support for remote boot of Windows 95 workstations will be available in upcoming releases of Windows NT. For information about Windows NT support, contact your sales support representative.

Server-based Setup replaces the Administrative Setup process used for Windows 3.x and Windows for Workgroups. The following table compares the actions required on older versions of Windows to the Windows 95 methods.

Methods for Creating Network-based Setup and Shared Installations

Windows for Workgroups	Windows 95
Run setup /a to create a Windows distribution directory on the network	Run Server-based Setup under Windows 95 (netsetup)
Customize INF files for system, desktop, applications, and Program Manager	Create a setup script in MSBATCH.INF format
For shared installations, create network directories and configure shared files	Included automatically as part of Server-based Setup
For shared installations, create correct configuration files and startup disks for each workstation to define settings for MS-DOS, Windows, and networking software	Included automatically as part of the setup script and Windows 95 Setup
Run setup /n on each workstation	Run Windows 95 Setup with setup script (setup msbatch.inf)

When you use Server-based Setup to create shared installations for computers that start from a floppy disk or for remote-boot workstations that use a disk image on a server, you need to run Setup only once for each type of computer. Server-based Setup can create machine directories for the other similar computers. So you only have to make copies of the startup disk (either the floppy disk or the boot image).

Therefore, for example, for shared installations of Windows for Workgroups on remote-boot workstations, users simply restart their workstations to upgrade to Windows 95. For upgrading shared installations that start from floppy disks, users can upgrade by simply restarting their computers with the new startup disk.

Server-Based Setup: The Issues

The Server-based Setup program is available only on the Windows 95 compact disc in the ADMIN\NETTOOLS\NETSETUP directory. Server-based Setup is not provided on the Windows 95 floppy distribution disks.

Important Server-based Setup can be run only from a computer running Windows 95.

You cannot run Server-based Setup from Windows 3.1, Windows for Workgroups, Windows NT, or MS-DOS.

Typically, shared installations are used where there might be users who need to access various computers for tasks such as point-of-sale data entry. Shared installations are also typically used on enterprise networks with many thousands of similar computers.

The most important consideration in deciding how to run Windows 95 in the corporate environment is the current configuration for workstations running Windows 3.x. If the largest portion of workstations currently run shared Windows, then the upgrade process is straightforward if you continue to use a shared configuration. If you decide to change a workstation to run Windows 95 from the local hard disk, applications must be reinstalled and desktop settings reconfigured in addition to installing the new operating system.

The basic benefits of installing Windows 95 on the local hard disk of a computer include the following:

- Performance is superior
- Less network traffic is generated
- The system can start and continue running if the server is not available
- The user has more freedom to customize the system, if system policies don't restrict this

The benefits of a shared installation include the following:

- Little or no hard disk space is required on the local computer
- Updating drivers for multiple computers is easier
- The workstation is more secure and operation is safer for novice users, because network logon is required and access to system files is limited (although you can use system policies to enforce the same restrictions for local installations)

Although an entirely shared configuration makes it easy to maintain the system, a shared configuration also means more network traffic and requires larger servers.

The following sections provide some guidelines and summary information for planning the installation process for computers that will run a shared copy of Windows 95. This information supplements that planning and implementation information presented in [Deployment Planning Guide](#).

Planning for Machine Directories

For a shared installation on each computer that starts from a floppy disk or a remote-boot disk image, the machine directory is a required network directory that contains the particular files required for that specific configuration. The machine directory contains WIN.COM, the full Registry, and startup configuration files such as SYSTEM.INI.

Both Windows 95 Setup and Server-based Setup can create machine directories automatically, as described in [Task 2: Creating Machine Directories](#). For shared installations for floppy disk-based and remote-boot workstations, you need to run Windows 95 Setup only once for each type of computer configuration. Then you can use Server-based Setup to create machine directories for other computers. You can replicate the startup disks (or boot images) for other computers of the same type.

For computers that start from the hard disk, machine directories are optional; however, you must run Windows 95 Setup on each computer that has a hard disk, even if the computer will use a machine directory on the network.

The machine directory is for computer-specific settings. This is different from the individual user directories on Windows NT networks or the individual Mail directories on NetWare networks, which contain user-specific files such as login scripts or user profiles for individual users. Using machine directories offers several benefits:

- Computer-specific settings are saved in a central location, rather than with user-specific settings. So the correct configuration is available for the particular computer, no matter which user logs on.
- A single boot image on the network (or single version of the floppy startup disk) can be used to start several computers.
- The administrator can easily create and replicate shared Windows 95 installations for new computers from a central location, often without having to run Windows 95 Setup repeatedly.

Windows 95 files for a shared installation are stored in the locations described in the following table.

File location	Description
Startup disk	Contains the real-mode software necessary to start the computer and connect to the shared Windows directory, including the mini Registry used to start the computer. The startup disk for a shared installation can be a local hard disk, a floppy disk, or a remote-boot disk image stored on a server.
Machine directory	Contains files specific to a particular computer (not a particular user), including the full Registry. This also includes the default USER.DAT file, which is updated with the user's personal USER.DAT if user profiles are enabled on the network. The machine directory can exist on any shared network resource. Machine directories must exist on the network for computers that start from a floppy disk or for remote-boot workstations, and are created locally by default for shared installations on computers that have hard disks.
Shared Windows 95 directory on a server	Contains all the shared Windows 95 files. This directory is marked read-only automatically during installation of the source files.

Planning for Shared Installations

This section summarizes some technical issues related to shared installations of Windows 95.

Technical issues for all network clients on shared installations.

Network logon is required before running Windows 95 on shared installations, because network connectivity is required before Windows 95 can run across the network. This can be a generic logon, rather than specific user logon. For more information, see [Configuring Shared Installations](#).

- One Windows 95 software license is required for each computer that will run Windows 95.
- Because most or all of the Windows 95 files are located on the server for shared installations, loading the shared Windows 95 components increases network traffic.
- Each client computer must use all 32-bit, protected-mode networking components or all 16-bit, real-mode components, not a combination of real-mode and protected-mode components.

Important After Windows 95 installation is complete, all path statements in login scripts must specify Windows 95 locations, and not Windows 3.x or MS-DOS. Make sure that **path** variables are set correctly in login scripts to avoid unexpected behavior.

Technical issues for Microsoft protected-mode clients.

These issues are important in your planning for shared installations that use Microsoft Client for NetWare Networks or Client for Microsoft Networks:

- Each client computer must use all 32-bit, protected-mode networking components. For example, a computer running a shared installation cannot run a network client such as Microsoft Client for NetWare Networks using ODI network adapter drivers.
- Real-mode components are required for the first connection to the network during system startup. Microsoft TCP/IP in Windows 95 runs only in protected mode, so the computer must load an IPX/SPX or NetBEUI protocol to make the real-mode connection to the network. After the system loads and switches to protected mode, then Microsoft TCP/IP can be used. Real-mode versions of NetBEUI and IPX/SPX-compatible protocols are built into the real-mode software that is used to make the first connection to the server before Windows 95 starts.
- You cannot use existing NDIS 2.x or ODI drivers to support protected-mode networking clients. For either Client for NetWare Networks or Client for Microsoft Networks, the network adapter must have an NDIS 3.1 driver (although an NDIS 2 driver is used for the first connection to the server during system startup).
- For protected-mode network clients, you cannot use a PCI network adapter or ISA adapters on a PCI computer for system startup over the network. This is because PCI adapters do not start until the second booting of Windows 95. For shared installations, the adapter must start on the first boot.

Note If a computer has an IBM 16/4 token-ring adapter and has been using ODI drivers, Windows 95 Setup uses the existing ODI driver by default. To use this adapter with a 32-bit, protected-mode network client, you must remove the existing ODI driver and replace it with the Windows 95 NDIS 3.1 driver for the IBM 16/4 token-ring adapter. For information about the specific statements for installing the NDIS 3.1 driver for this adapter as part of a setup script, see [MSBATCH.INF Parameters](#).

Technical issues for other network clients.

Client computers can run a shared copy of Windows 95 from a server using real-mode network software other than the Microsoft real-mode networking software used for system startup. However, computers that don't use the Microsoft real-mode network software for system startup cannot use protected-mode network clients (such as Client for Microsoft Networks or Client for NetWare Networks).

Shared installation requirements.

Server-based Setup operates on one server at a time. You specify a particular server where Windows 95 files are to be installed and where related machine directories will be created for shared installations.

However, the machine directories do not need to be created on the same server where the Windows 95 files are installed. In fact, to balance the network load, you might prefer to designate specific servers to maintain the Windows 95 source files, and other servers to contain the machine directories and login scripts. Typically, you need to make Windows 95 source files available from multiple servers, both to provide fault tolerance and to reduce network traffic.

On the server, 90 MB of hard disk space is required for the Windows 95 source files. The following

summarizes the disk space required for each machine directory on a shared installation, not including the swap file space requirements.

Disk Space Requirements for Server and Local Hard Disks

Startup type	Local hard disk space	Server disk space
Local hard-disk startup, local Windows 95	20 MB	0
Local hard-disk startup, Windows 95 on a server ¹	2 MB (1 MB)	1.5 MB (optional)
Floppy-disk startup, Windows 95 on a server	1.2 MB floppy drive	2 MB
Remote-boot startup, Windows 95 on a server	0	2 MB

¹ If this configuration uses a machine directory on a server, only the Registry and basic files are local.

The following table summarizes the memory requirements for client computers running Windows 95.

Recommended Client System Configuration for Windows 95

Windows 95 location	Protected-mode ¹ RAM	Real-mode ² RAM
Local hard-disk startup, local Windows 95	8 MB (4 MB) ³	8 MB (4 MB)
Local hard-disk startup, Windows 95 on a server	8 MB (4 MB)	8 MB (4 MB)
Floppy-disk startup, Windows 95 on a server	8 MB (4 MB)	8 MB (4 MB)
Remote-boot startup, Windows 95 on a server	8 MB (6 MB)	8 MB (4 MB)

¹ Microsoft Client for NetWare Networks or Client for Microsoft Networks.

² For example, Novell NetWare NETX real-mode client.

³ The first number indicates recommended memory; the second value is the minimum requirement.

Swap file requirements for shared installations.

By default, the swap file for a shared installation is stored in the machine directory. For floppy-disk and remote-boot computers, this means that all paging occurs across the network. If computers configured for floppy-disk or remote-boot startup have hard disks, you will see noticeable performance improvements as the swap file is placed on the hard disk.

To change the location for the swap file, add the entry **pagingfile=c:\win386.swp** in the [386Enh] section of the SYSTEM.INI file stored in the machine directory. You can add this setting automatically using an [Install] section in the setup script, as described in [MSBATCH.INF Parameters](#).

The swap file size requirements vary, depending on the amount of RAM in the client computer, the number and kinds of applications that are run, and other factors. For guidelines on swap file size, see [Performance Tuning](#).

Server-Based Setup: An Overview

To install Windows 95 source files on the network and create setup scripts, you must run Server-based Setup under Windows 95, and follow the instructions to do the following:

- Copy the Windows 95 source files onto the server, as described in [Task 1: Copying Windows 95 Files to a Server](#).
This is the only step required to make Windows 95 source files available for running Windows 95 Setup from a network source.
- For shared installations, create a machine directory for each computer, as described in [Task 2: Creating Machine Directories](#). This step is required for floppy disk-based and remote-boot installations. For computers that start from the hard disk, you must run Windows 95 Setup on each computer, even if the computer will use a machine directory on the network.
- Create setup scripts for automated installation of Windows 95 on client computers, as described in [Custom, Automated, and Push Installations](#).

The following illustration summarizes the main tasks that are performed using Server-based Setup.

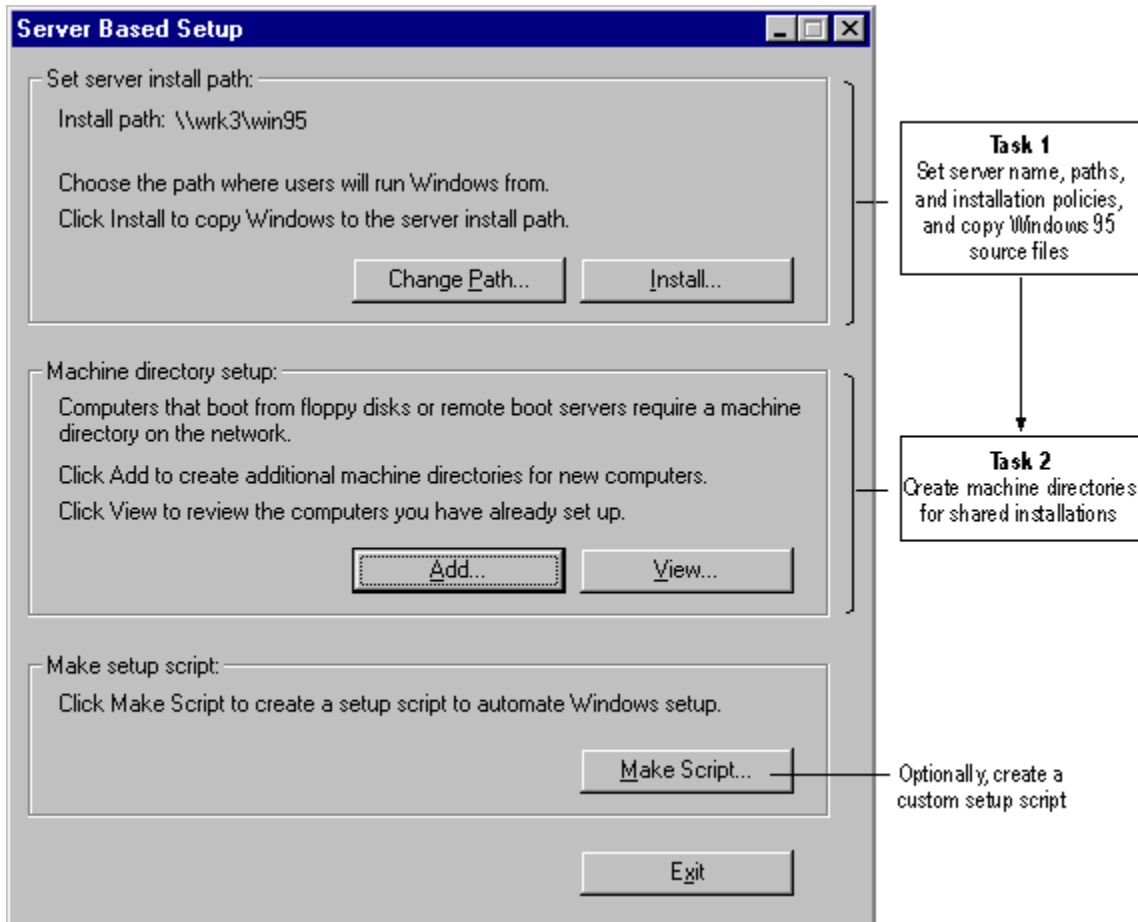

After you have completed these preliminary tasks, you can run Windows 95 Setup to complete the installation, as described in [Installing Windows 95 for Shared Installations](#).

Note Run Windows 95 Setup from the directory where SETUP.EXE is stored.

In Windows 3.x, you had to switch to the directory you were setting up before running **setup /n**. This is no longer necessary in Windows 95.

The files that make up Server-based Setup are uncompressed files in the ADMIN\NETTOOLS\

NETSETUP directory on the Windows 95 compact disc. The program can be run directly from the compact disc, which is the recommended method.

Task 1: Copying Windows 95 Files to a Server

To place the Windows 95 source files on a server, you must run the Server-based Setup program. Using **netsetup** replaces the **setup /a** method used for Windows 3.x and Windows for Workgroups.

Note The procedures for Task 1 are the only steps you need to complete if you want to place Windows 95 source files on a server for installation on computers that will run Windows 95 from their local hard disks.

You can install the source files for shared Windows 95 installation on one of the following networks:

- Banyan® VINES® 5.52
- Microsoft Windows NT Server
- Novell NetWare 3.x and 4.x

You can also place the Windows 95 source files on servers for installing Windows 95 locally on the following kinds of networks:

- Artisoft® LANtastic® 5.x
- DEC™ PATHWORKS™
- IBM® OS/2® LAN Server 1.2 or greater
- Microsoft LAN Manager 2.x
- Microsoft Windows 95 peer server (for Microsoft or NetWare networks)
- SunSoft™ PC-NFS® 5.0



To get ready to copy Windows 95 source files on to a server

- From the network administrator's computer, log on to the network file server where you will place the Windows 95 source files.

Make sure you log on with security privileges that allow you to create directories and copy files on the network file server.



To run Server-based Setup

1. Run Windows 95.
2. Insert the Windows 95 compact disc in the CD-ROM drive, and make sure that it is the active drive. Then switch to the ADMIN\NETTOOLS\NETSETUP directory.
3. In Windows Explorer, double-click NETSETUP.EXE.

The Server-Based Setup dialog box appears so that you can begin installing source files and other tasks.

The Server-Based Setup dialog box shows the currently selected server where source files are to be installed.

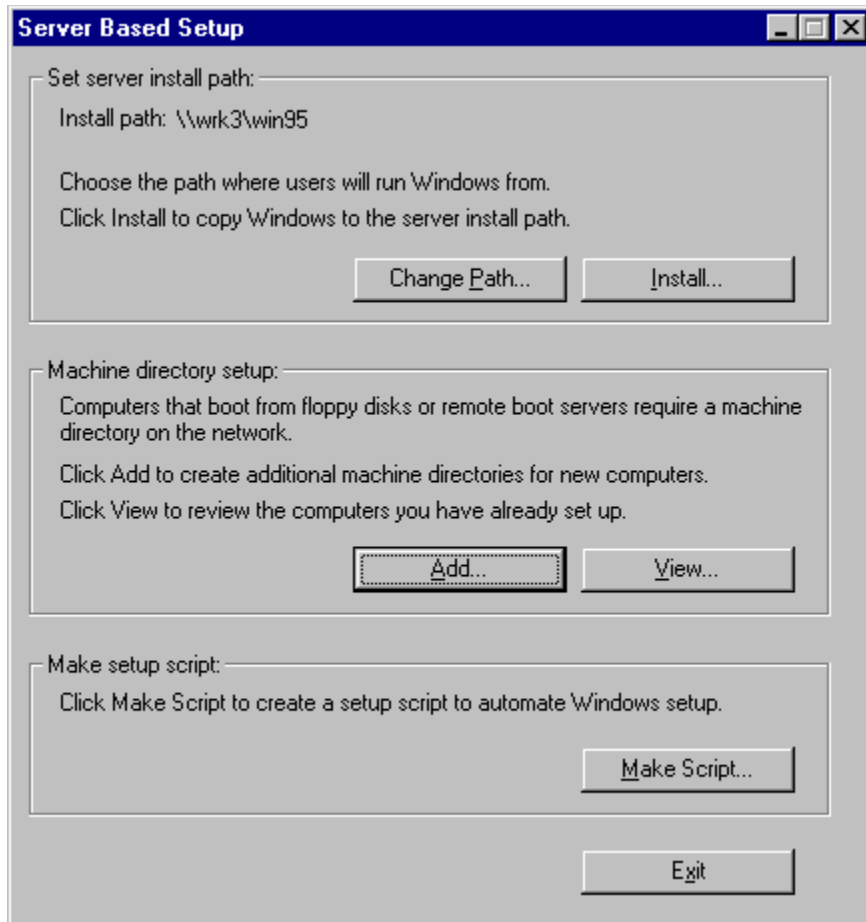

The following procedure summarizes the steps for installing source files using Server-based Setup. The following sections provide details about the steps required to set up the server.



To install Windows 95 source files on a server

1. In the Server-Based Setup dialog box, click the Set Path button, and then specify the server path. Then click OK.
The button name becomes Change Path if a server path was defined previously.
2. Click Install. Server-based Setup presents a series of dialog boxes so that you can complete these actions:
 - Set the server path where the source files are to be installed
 - Specify how users can install Windows 95 from the server — on a local hard disk, as a shared copy, or as the user chooses
 - Install Windows 95 source files in the shared directory you specify
 - Specify whether you want to create a default setup script, and then define the settings in the script, if you choose to create one
 - Provide a CD Key number for product identification

Tip After installing the Windows 95 source files in a network directory, make sure to copy any required VxDs or DLLs from other vendors into the appropriate Windows 95 subdirectory on the server. For information, see [Custom, Automated, and Push Installations](#).

Server-Based Setup for Windows 95

Task 1: Copying Windows 95 Files to a Server

Selecting the Server

In the Server-Based Setup dialog box, the Set Server Install Path box shows the mapped drive or the UNC path for the selected server.



To define the path where source files will be installed

1. In the Server-Based Setup dialog box, click Set Path (or Change Path, if a path has already been set).
2. In the Server Path dialog box, type the drive letter for a mapped drive or the UNC path to the server where you want to install Windows 95 source files. Then click OK.

For example, if the server where you want to install the files is named NWSVR1 and the share is WIN95SRC, type:

```
\\nwsvr1\win95src
```

Notice that you can specify a UNC path for a NetWare server if you are already attached to that server.

If you specify a subdirectory on the server and that directory does not already exist, Server-based Setup asks if you want to create the directory, and then completes this action if you confirm the message.

If you have insufficient privileges for connecting to or creating a directory on the specified server, a message warns you. You can specify another server, or quit Server-based Setup and log on using an account that has sufficient privileges on the specified server.

When Server-based Setup is set to a new path, it looks for the Registry file (NETSETUP.POL) that it uses to track which computers have been set up. Each time you use Server-based Setup to create a machine directory, an entry is added to this file. No entry is added when a user runs Windows 95 Setup from that shared directory.

Note NETSETUP.POL is read only by Server-based Setup to create MSBATCH.INF. You cannot run System Policy Editor to read or modify NETSETUP.POL. Also, you cannot edit MSBATCH.INF using Server-based Setup; you must edit setup scripts using a text editor.

Server-Based Setup for Windows 95

Task 1: Copying Windows 95 Files to a Server

Setting the Destination Path and Installation Policy

After you set the server name, you can install the Windows 95 source files on that server. You must specify the source and destination paths for copying the source files, and set the installation policy that specifies whether users running Windows 95 Setup from this server are installing Windows 95 to run from their local hard disk or are preparing to run a shared copy from the server.



To set the destination path and installation policy for a server

1. In the first Server-Based Setup dialog box, click the Install button to display the Source Path dialog box.

Server-based Setup stores the settings made in this dialog box in the default MSBATCH.INF file created as part of the Server-based Setup process.

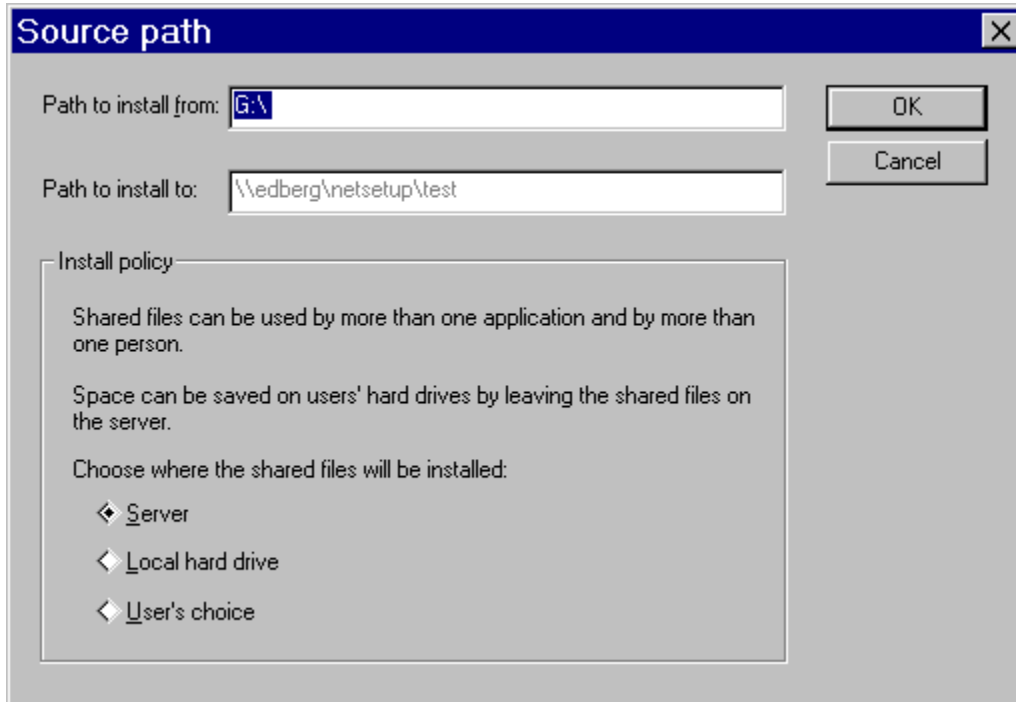

2. Select an installation policy option as described in the following table.

Installation policy	Resulting installation capability
Server	Allows only shared installation of Windows 95. Select this option if the source files on this server are to be used by client computers to run a shared copy of Windows 95.
Local Hard Disk	Allows installation only on a local hard disk. Select this option if all Windows 95 files are to be stored on each computer's local hard disk.
User's Choice	Prompts the user to specify either shared or local installation. Select this option if you are allowing users to choose whether to run a shared installation, or if you are using setup scripts to install different types of installations using the same source files.

If you select either User's Choice or Local Hard disk, you will not be prompted to specify machine

directories. If you do not define machine directories, Setup will use a default machine directory. For information about creating machine directories, see [Task 2: Creating Machine Directories](#).

3. In the Path To Install From box, type the path for the source of the Windows 95 distribution files. The first time you install the source files, this is the path to the CD-ROM drive and directory that contains the source files on the Windows 95 compact disc.

If you subsequently install source files on other servers, you can specify the path to a network directory that contains the Windows 95 source files.

4. In the Path To Install To box, type the path to the directory where the Windows 95 source files are to be installed.

This must be a directory on the selected server where you want to copy the source files. (Server-based Setup will create the directory if it does not already exist on the server.)

For both Path boxes, you can either type a drive and directory path or specify a UNC path name.

5. Click OK to continue to the next part of Server-based Setup.

Creating a Default Setup Script

Server-based Setup can create a default setup script automatically by storing the setup options you specify in an MSBATCH.INF file that is placed with the Windows 95 source files on the server. This default setup script can be used to install Windows 95 on individual computers, or it can be used as a template to create other versions of the setup script.

This section summarizes the procedural steps related to creating a default script while installing Windows 95 source files on a server. For information about making a script based on choosing the Make Script button in the Server-Based Setup dialog box, see [Custom, Automated, and Push Installations](#). For information about the specific settings in MSBATCH.INF, see [MSBATCH.INF Parameters](#).

When you click OK in the Source Path dialog box after specifying the destination path and installation policy option, Server-based Setup automatically prompts you to specify whether a default setup script should be created. If you choose to create a default script, it will be saved as MSBATCH.INF on the server.

The decision about whether to create a default setup script depends on the following:

- Principally, whether you want to control installation settings for users who install Windows 95 from this server
- Whether you want to use the default settings to create custom scripts
- Whether you previously created a setup script and do not require a new default script



To continue with Server-based Setup without creating a default script

- In the Source Path dialog box, click OK. Then, in the Create Default dialog box, click the Don't Create Default button to begin installing Windows 95 source files on the server.

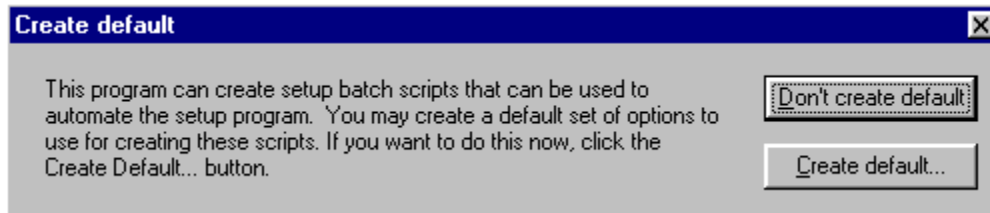

To create a default script for automating Windows 95 Setup

1. In the Create Default dialog box, click the Create Default button.

Server-based Setup displays the SBS Default Policies page for creating an MSBATCH.INF file that contains the specific configuration settings.

2. Click options to check all the components you want to define in the setup script and, where required, type values in the Settings box. After you have defined all components for the script, click OK.

For information about the values defined in the setup script, see [MSBATCH.INF Parameters](#).

Some options require that you select or type additional information in the Settings box at the bottom of this dialog box.

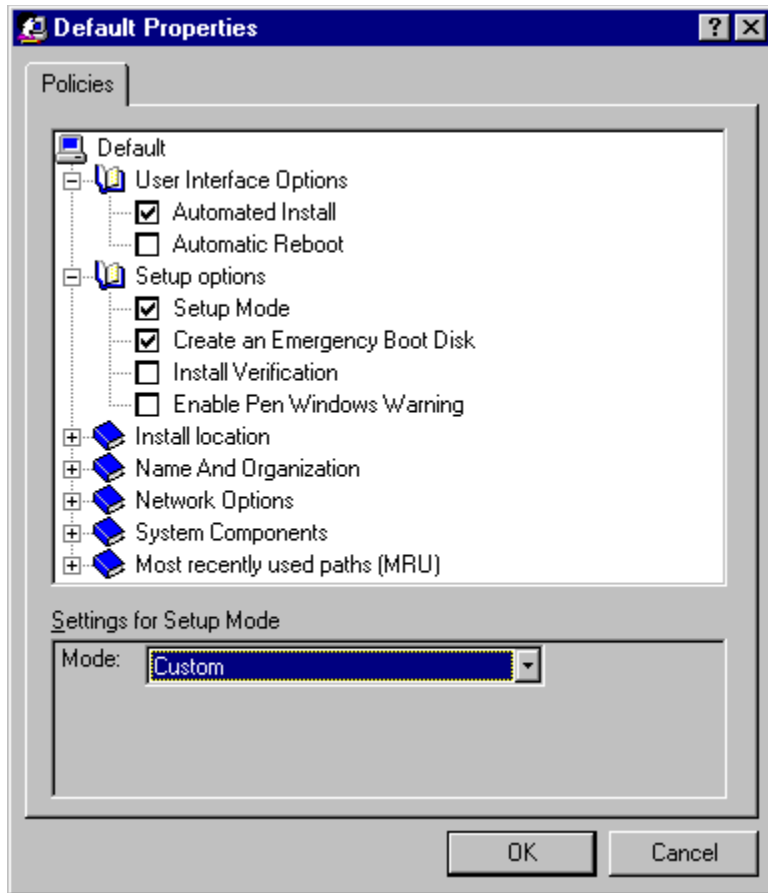

Notice that although Server-based Setup uses the System Policy Editor user interface, this procedure does not create system policies. Only a setup script is created.

Server-Based Setup for Windows 95

Task 1: Copying Windows 95 Files to a Server

Installing Files on the Server

After you complete all choices for a default setup script, Server-based Setup prompts you to supply the CD Key identification number. You can find the 10-digit CD Key number on the yellow sticker on the Windows 95 compact disc case.

When Server-based Setup has all the information it needs, it installs Windows 95 source files on the selected server, performing the following tasks:

- Windows 95 source files are copied to the server, using the same hierarchical directory structure used when files are copied to the hard disk.
- An MSBATCH.INF file is created on the server, based on the default computer settings. This setup script is used whenever users run Windows 95 Setup from the shared directory on the server without specifying the filename for another setup script.

When Server-based Setup is finished, the server should have the following directory structure (rather than the flat directory structure created by the Windows 3.x **setup /a** command):

destination directory

```
Command
Config
Cursors
Fonts
Inf
Media
Progra~1
  Access~1
  Themic~1
  Micros~1
Shellnew
System
  Color
  Iosubsys
  Viewers
Vmm32
```

Note Windows 95 source files and other shared system files are marked read-only automatically during installation of the source files. You do not need to use the NetWare FLAG command or any other procedure to set sharable attributes.

Task 2: Creating Machine Directories

When you run Windows 95 Setup to create a shared installation for a client computer, information is stored in the client computer's machine directory (not in individual users' home directories). The machine directory contains the following kinds of configuration information:

- Appropriate initialization and configuration files (including WIN.INI and SYSTEM.INI)
- SYSTEM.DAT and USER.DAT files, which make up the Registry for the shared installation
- Files that define the Desktop, Start menu directories, and other programs
- The spool directory for printing

For floppy disk-based and remote-boot computers, the swap file and TEMP directory are also placed in the machine directory. You must create machine directories on a server for floppy disk-based and remote-boot shared installations. Using machine directories is optional for computers with hard disks that are running a shared version of Windows 95.

You can set up the machine directory for a single computer or specify the filename of a text file that defines machine directories for multiple computer names.



To specify machine directories for multiple computers

1. Create a text file that contains a list of computer names with the related location of machine directories that are to contain Windows 95 computer-specific files.

In this text file, the entry for each machine directory must appear on a separate line, in the following format:

```
computername, \\UNC_server_name\directory\machine_directory
```

For example:

```
machine1, \\nwsvr1\netsetup\machine1  
machine2, \\nwsvr1\netsetup\machine2
```

2. Save the file in text-only (ASCII) format, using any filename and storing it in any shared directory.



To create machine directories using Server-based Setup

1. In the Server-Based Setup dialog box, click Set Path (or Change Path), and specify the path for the server that contains the Windows 95 source files. Then click OK.
2. Click the Add button.

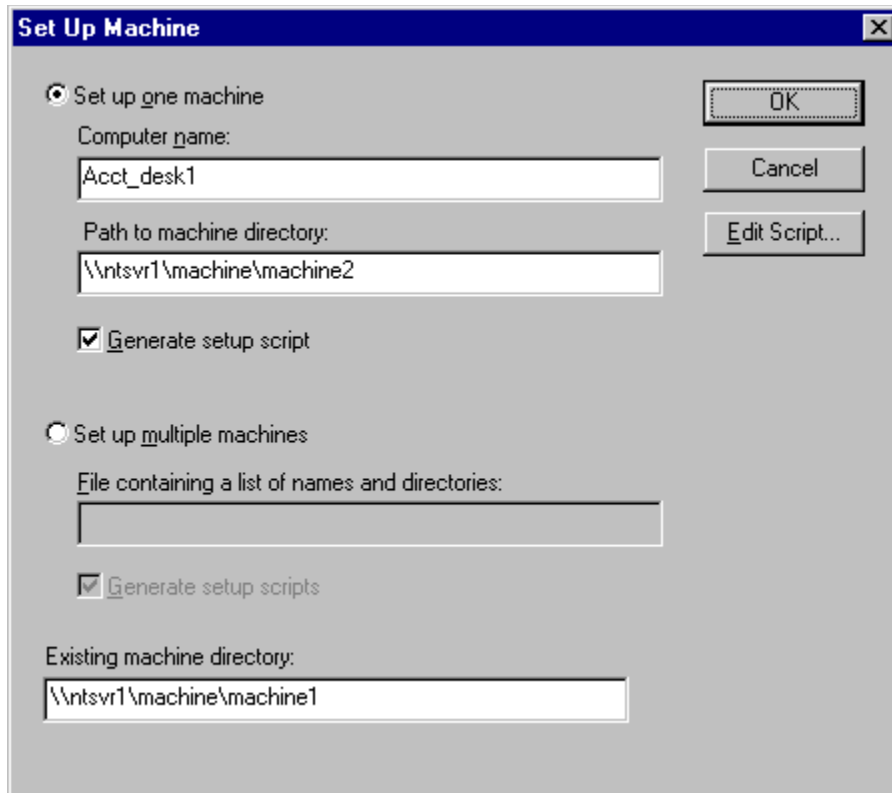

3. In the Set Up Machine dialog box, click an option to specify whether you are adding a single machine directory or multiple directories:
 - If you want to add a machine directory for a single computer, click Set Up One Machine. Then specify the name of the computer and the path to its machine directory.
 - If you want to add multiple machine directories using a batch file, click Set Up Multiple Machines. Then type the path and filename of the batch file that contains the list of computer names and machine directories. (This is the file created in the previous procedure.)
If the file is stored on another server, type the UNC path to the directory.
4. If you want Server-based Setup to create setup scripts based on the values set in this dialog box and the default script created in Task 1, make sure the related Generate Setup Script option is checked.
5. If you want to create a shared installation based on the configuration in an existing machine directory, specify that directory in the box named Existing Machine Directory.
You can see a list of the machine directories created in the currently selected server by clicking the View button in the Server-based Setup dialog box.
6. After you have specified all the options you want, click OK.
Server-based Setup creates the specified machine directories and, if you specified that a setup script should be created, it stores a setup script in each machine directory.

Tip for Setting Up Machine Directories

The best way to take advantage of Server-based Setup for setting up multiple computers is to specify options and run Windows 95 Setup to create a shared installation for one computer. Then, for each group of computers that have the same network adapter and that will start a shared copy of Windows 95, you can use the Set Up Machine dialog box to automatically create machine directories for all computers of the same type.

By using Server-based Setup in this way, you only need to run Windows 95 Setup once for each type of computer configuration. Setup will automatically

create machine directories and copy the main Windows 95 files, such as the Registry files, INI files, program groups, and so on, to each new machine directory. For each machine directory, Setup also updates the Registry to set the correct path to the machine directory and to prepare the Run-Once actions to convert program groups and complete other actions.

Server-Based Setup for Windows 95

Installing Windows 95 for Shared Installations

Each computer that starts from a hard disk must run Windows 95 Setup. For remote-boot workstations or floppy disk-based computers, run Windows 95 Setup once for each class of computers — that is, workstations that have identical network adapter configurations. Similar computers can then use their own machine directories with the startup floppy disk or boot image to run Windows 95.

The setup script tells Windows 95 Setup what kind of installation is allowed, based on the installation policy specified in Server-based Setup. The script can force a local hard-disk installation or a shared installation, or allow either. If the script is set to allow either, Setup asks the user to specify a shared or local installation.

Notice, however, that Windows 95 can be installed for remote-boot workstations only by specifying **RPLSetup=1** in the [Network] section of a setup script.

For shared installations, you can use the default version of MSBATCH.INF stored on the server plus a list of computer names and machine directories to generate a setup script for each client computer. You can also create custom setup scripts using the MSBATCH.INF format. Also, you can archive setup scripts, in case you need to run Setup again for a particular computer (for example, if the Registry becomes corrupted and cannot be restored).

The appropriate setup script is specified as a command-line parameter when running Windows 95 Setup. As described in [Custom, Automated, and Push Installations](#), you can use the following basic approaches for installing Windows 95 with setup scripts:

- Run Windows 95 Setup with a setup script from the command line; for example:

```
setup n:\bob\bob.inf
```
- Use a login script that includes a command line to run Setup with a setup script, automatically installing Windows 95 when the user logs on
- Use Microsoft Systems Management Server or network management software from other vendors to run Windows 95 Setup with a setup script

When Windows 95 Setup runs with a setup script, Setup performs the following for both local hard-disk and shared installations:

- Detects and configures the hardware, storing the configuration in the computer's machine directory
- Prompts the user to specify or change any settings that are not defined in the setup script

For shared installations, the following additional installation tasks are performed:

- If **DisplayWorkstationSetup=1** is specified in the setup script, Setup prompts the user for the path to the machine directory, if a path isn't specified in the setup script
- Setup creates the startup disk (or boot image), as described in [Configuring Shared Installations](#)
- If a protected-mode network client is to be used, Setup configures the system for making the transition from real-mode networking

Configuring Shared Installations

The following sections present information about the specific configuration files for each type of shared installation.

The default settings defined in MSDOS.SYS will also affect system startup on shared installations. For information about these defaults and how to change settings, see [Setup Technical Discussion](#).

Important After Windows 95 is installed, make sure that all path statements in login scripts specify Windows 95 locations, and not Windows 3.x or MS-DOS. Unexpected behavior or system instability can occur when erroneous **path** variables are set in login scripts.

Configuring Shared Installations for Protected-Mode Clients

For shared installations, Windows 95 Setup adds the following basic kinds of entries in AUTOEXEC.BAT for computers that will run a shared copy of Windows 95 and use basic Microsoft networking for the first connection to the server:

```
snapshot
net start redir
net use drive: \\server\shared_source
net use drive: \\server\share\machine_dir
setmdir
```

If AUTOEXEC.BAT previously included **net start** or **net init** statements, Windows 95 Setup adds the commands for a shared installation at the same location. If AUTOEXEC.BAT included command lines for MS-DOS-based utilities before the **net start** entry, you must place these after **net start** for an AUTOEXEC.BAT file to be used with Windows 95.

For example, the earlier version of AUTOEXEC.BAT might contain these statements:

```
doskey
net start
```

Windows 95 Setup would change this AUTOEXEC.BAT to contain these statements:

```
drive:\sharredir\doskey
net start basic
net logon /y
```

You must then manually edit AUTOEXEC.BAT to move the **doskey** statement after the **net** statements.

The SNAPSHOT.EXE utility called in AUTOEXEC.BAT is a real-mode program that prepares for the transition to protected-mode networking. A protected-mode counterpart (SNAPSHOT.VXD, stored in the shared Windows SYSTEM directory) uses this information to load the protected-mode network client. The following list shows command-line parameters that Setup might add in AUTOEXEC.BAT.

Parameters for SNAPSHOT.EXE

Parameter	Description
/B:n	Sets <i>n</i> as the boot drive, where <i>n</i> is a drive letter A through Z. Usually this is set to /b:c .
/M:n	Sets the amount of memory to reserve for the real-mode network, where <i>n</i> is a number in kilobytes. The default is 160K.
/S	Enables shutdown trapping, which causes Snapshot to intercept the Windows shutdown process and restart the workstation as soon as it is disconnected from the network. This parameter is used for floppy disk-based and remote-boot computers that use swap files on the network.
/R	Indicates that this is a diskless workstation that has no floppy disk drives. (On some remote-boot computers, the BIOS reports drives A and B when these drives don't exist; this parameter solves that problem.)
/V	Sets verbose mode.

The **net start** command includes either the **basic** or **nwredir** parameter to start real-mode Microsoft networking. For either parameter (and any type of network), the **net use** command is then used to connect to make the initial network connection. The user is prompted for a user name and password for this real-mode connection. Otherwise, you can modify AUTOEXEC.BAT to use a generic logon for this first connection.

Note If the computer uses more than one network client, the first client specified in the **clients=** entry in the setup script will be used to run Windows 95. If the first client specified in **clients=** is a Windows 95 protected-mode client, then that client is used with the **net start** command.

The **net use** entries in AUTOEXEC.BAT map drives for the shared Windows 95 files and the machine directory for the computer. The **setmdir** command (that is, Set Machine Directory) searches for MACHINES.INI in the shared Windows 95 directory to locate an entry that specifies the path to the machine directory that contains the full Registry for this computer. For more information, see Technical Notes on MACHINES.INI and SETMDIR.

The startup disk for a shared installation contains all the software required to connect to the network and start Windows 95. One startup disk can be used for computers with the same kinds of network adapters and settings. The same configuration can be used to run a shared copy of Windows 95 on remote-boot workstations with similar hardware configurations.

For computers that start from floppy disks, the contents of the startup disk fit on a 1.2 MB floppy disk. After Setup, you should make sure that the startup disk is write-protected. The software on the disk does not require writing information to the startup disk.

Server-Based Setup for Windows 95

Configuring Shared Installations

Configuring Shared Installations for Protected-Mode Clients

Configuring a Computer that Starts from a Hard Disk

If you want to run a shared copy of Windows 95 on a computer that starts from its local hard disk, the setup script should contain the following entries:

```
[network]
WorkstationSetup=1
HDBoot=1
```

In this case, if there is a hard disk present on the computer with sufficient space for the required files, Windows 95 Setup creates the configuration required to start the computer from the Windows directory on the local hard disk and run a shared copy from the network.

Optionally, if the entry **DisplayWorkstationSetup=1** is specified in the setup script, the user can choose to create a local installation or a shared installation of Windows 95. For a shared installation, the user must specify the path for the machine directory.

For a computer that starts from a hard disk and uses Client for Microsoft Networks, AUTOEXEC.BAT is set up as follows for a shared installation:

```
snapshot.exe
net start basic
net logon /savepw:no /y
net use x: \\server\share
```

For computers running a NetWare-compatible client as the default network client, AUTOEXEC.BAT is as follows:

```
snapshot.exe
net start nwredir
net use drive: \\server\directory
```

The following shows an example of AUTOEXEC.BAT for a computer that starts from its local hard disk:

```
snapshot
c:\windows\net start nwredir
c:\windows\net use * /d
c:\windows\net use r: \\nwsvr\sys
path c:\windows;r:\sbsdinst;r:\sbsdinst\command
set tmp=c:\windows
set temp=c:\windows
```

Setup creates a machine directory and copies the following files to the machine directory:

- WIN.COM
- All initialization files, including WIN.INI and SYSTEM.INI
- USER.DAT

Notice that the USER.DAT portion of the Registry must be in the machine directory for user profiles to work. During network logon, Windows 95 copies the correct USER.DAT to use if user profiles are enabled.

Setup places SYSTEM.DAT on the local hard disk.

Because all Windows 95 source files are on the server, Setup does not need to copy Windows 95 locally as it does for installation on a local hard disk. The File Copy step in Setup should only copy about 2 MB of files.

For shared installations on computers with hard disks, Setup modifies the Windows 95 startup disk by changing the boot sector and copying new IO.SYS, COMMAND.COM, and MSDOS.SYS files. The files in the following list are copied to the startup disk.

Files on Startup Disk for Shared Installations on Hard-Disk Computers

autoexec.bat	msdos.sys	protman.exe
command.com	ndishlp.sys	protocol.ini
config.sys	net.exe	snapshot.exe
himem.sys	net.msg	system.dat
ifshlp.sys	neth.msg	NDIS 2 adapter driver
io.sys	protman.dos	

For a client computer that contains a hard disk, the swap file and TEMP directory are stored on the local hard disk. To change the location for the swap file in this configuration, add a **pagingfile=***path* entry in the [386Enh] section of the SYSTEM.INI file that is stored in the machine directory.

Server-Based Setup for Windows 95

Configuring Shared Installations

Configuring Shared Installations for Protected-Mode Clients

Configuring a Computer that Starts from a Floppy Disk

If you want to run a shared copy of Windows 95 on a computer that starts from a floppy disk, the setup script should contain the following entries:

```
[network]
WorkstationSetup=1
HDBoot=0
RPLSetup=0
```

Windows 95 Setup creates the configuration required to start the computer from a floppy-based startup disk and run a shared copy from the network. Setup also creates this configuration if **HDBoot=1** is specified but there is no hard disk present or there is insufficient space on the hard disk to install the required files.

Note You must add an entry for the client computer in MACHINES.INI before that computer can start Windows 95.

For shared installations on floppy disk-based computers, Setup creates a mini Registry in a machine directory on the startup floppy disk. This reduced version of the computer's SYSTEM.DAT file contains only the information needed by IO.SYS and the real-mode network that makes the initial connection to the server. After connecting to the machine directory on the network, Windows 95 uses the full Registry stored there.

The swap file and TEMP directory are also stored in the machine directory for a client computer that starts from a floppy disk. To change the location for the swap file in this configuration, add a **pagingfile=path** entry in the [386Enh] section of the SYSTEM.INI file that is stored in the machine directory.

The following shows an example of AUTOEXEC.BAT for a computer that starts from a floppy disk to run Windows 95 from a NetWare server:

```
snapshot
net start nwredir
net use * /d
net use r: \\server\share
setmdir
path=sbsdist;r:\sbsdist\command
```

Note Do not include the machine directory in the path. The **setmdir** command manages this requirement automatically.

Windows 95 Setup creates the startup floppy disk by modifying the boot sector and copying IO.SYS. After Setup, make sure that the startup disk for this configuration is write-protected. The following table lists the files on the startup disk for this configuration.

Files on the Startup Disk for a Shared Installation on a Floppy-Disk Computer

autoexec.bat	msdos.sys	protman.exe
config.sys	ndishlp.sys	protocol.ini
command.com	net.exe	snapshot.exe
himem.sys	net.msg	system.dat (mini version)
ifshlp.sys	neth.msg	NDIS 2 adapter driver
io.sys	protman.dos	

Server-Based Setup for Windows 95

Configuring Shared Installations

Configuring Shared Installations for Protected-Mode Clients

Configuring a Remote-Boot Workstation for Client for NetWare Networks

Windows 95 can be installed on remote-boot workstations that start from Novell NetWare 3.x and 4.x servers. Remote-boot workstations contain a Remote Boot PROM that queries the network for instructions. Before installing Windows 95 to run on a remote-boot workstation, you should first make sure that the workstation successfully starts and runs with ODI drivers over RIPL.

If you want to run a shared copy of Windows 95 on a remote-boot workstation, the setup script should contain the following entries:

```
[network]
WorkstationSetup=1
HDBoot=0
RPLSetup=1
```

Windows 95 Setup creates the configuration required for starting and running a shared copy wholly from the network. Setup also creates this configuration on computers with NetWare-compatible clients if **HDBoot=1** is specified but there is no hard disk or floppy drive present or there is insufficient space on the hard disk to install the required files.

At system startup for a remote-boot workstation that will run Microsoft Client for NetWare Networks, the network provides instructions to create a RAM drive and then copies a disk image from the server to the workstation's RAM drive. Then the workstation continues booting from the RAM drive. The RAM drive is removed from memory after the operating system switches to protected mode. Windows 95 Setup creates the disk image that is copied from the server to the workstation's RAM drive. For information about customizing boot images, see [Creating the Disk Image for RIPL](#).

To accomplish these actions for remote-boot workstations, Setup adds the following line to the workstation's CONFIG.SYS to create the RAM drive:

```
device=a:\ramdrive.sys 1440
```

The following lines are added to AUTOEXEC.BAT:

```
@mkdir ramdrv:\
@copy a:\ ramdrv:\
```

When you run Windows 95 Setup on a remote-boot workstation, a mini Registry is created and copied to the RAM drive. Windows 95 Setup also copies other supporting startup files to the RAM drive. When Setup is finished, it creates a file containing a disk image of the workstation's RAM drive on the server. The startup disk image contains a reduced version of the computer's SYSTEM.DAT file, which contains the Registry information needed by IO.SYS and the real-mode network. After connecting to the workstation's machine directory, Windows 95 uses the full Registry stored there.

The following shows an example of AUTOEXEC.BAT created for a remote-boot workstation:

```
@copy a:\ c:\
c:
```

The following shows an example of WIN.BAT, which runs automatically after AUTOEXEC.BAT is run:

```
set comspec=c:\command.com
nwrpltrm
snapshot /R /S /B:C
net start nwredir
net use * /d
net use N: \\nwserverbasedsetup\sbsdist
path=n:\netsetup\rpl;n:\netsetup\rpl\command
setmdir
win.com
```

The machine directory is created on the server. Windows 95 Setup copies the files listed in the following table.

Startup Files for Remote-Boot Installations

autoexec.bat	msdos.sys	protman.exe
bootdrv.com	ndishlp.sys	protocol.ini
config.sys	net.exe	ramdrive.sys
command.com	net.msg	rplboot.sys
himem.sys	neth.msg	snapshot.exe
ifshlp.sys	nwrpltrm.com	system.dat
io.sys	protman.dos	NDIS 2 adapter driver

On remote-boot workstations, the NWRPLTRM.COM file runs during system startup to terminate the connection to the disk image. Users looking at the boot image on remote-boot workstations cannot see the RPLBOOT.SYS file

For remote-boot workstations, the network adapter is considered the boot device, and the real-mode operating system files are stored with the disk image in the machine directory. The swap file and TEMP directory are also stored in the machine directory. To change the location for the swap file in this configuration, add a **pagingfile=***path* entry in the [386Enh] section of the SYSTEM.INI file that is stored in the machine directory.

Configuring Shared Installations for Real-Mode Clients

All three types of shared installations can be used on computers that run real-mode network clients such as the Novell-supplied NETX or VLM workstation shells.

When a shared installation is created for a real-mode network, the system startup does not include a transition to 32-bit networking. After the initial connection to the network server, the networking software continues to run in real mode. This means that many performance and feature enhancements for Windows 95 are not available, but it also ensures that you can create shared installations on networks where 32-bit, protected-mode networking solutions are not yet available.

As for local installation of Windows 95, you should make sure that the real-mode networking software is installed and running correctly when you start Windows 95 Setup. Then run Windows 95 Setup, specifying the machine directory and other information required to create a shared installation.

The configuration settings created for shared installations using real-mode network clients does not include **snapshot** or **net** commands. Other configuration issues are described in the following notes.

Hard-disk computers with real-mode networking.

For computers that start from the hard disk, the configuration and system startup process are similar to that for computers that use protected-mode clients, except there is no transition to protected mode.

Floppy-disk computers with real-mode networking.

For computers that start from the floppy disk, Setup first asks for the old boot disk for the network, and then copies the information from the root directory on this disk to a temporary directory. Then Setup copies the required Windows 95 components to that directory. Finally, Setup copies the directory contents to the new startup disk for Windows 95. The startup disk still contains the original real-mode network software. This configuration uses **setmdir** (in the same way as configurations for protected-mode networking) in AUTOEXEC.BAT to find the correct machine directory, but the path is specified on the command line rather than in a MACHINES.INI file.

Remote-boot computers with real-mode networking.

This configuration uses **setmdir** (in the same way as configurations for protected-mode networking) in AUTOEXEC.BAT to find the correct machine directory, but the path is specified on the command line rather than in a MACHINES.INI file.

To prepare for running a remote-boot workstation using a NETX or VLM client with Windows 95, you must complete the following additional tasks:

- You must include the entry **SaveSuBoot=1** in the [Setup] section of the setup script.
- You must manually copy the Novell-supplied files to the *machine_dir*\SUBBOOT directory and then run RPLIMAGE again, as described in [Creating the Disk Image for RIPL](#). For information about the required files, see your Novell documentation.

Creating the Disk Image for RIPL

Novell NetWare does not provide RIPL support with its basic networking software. To obtain the latest versions of RIPL software, you can contact your Novell dealer or download the self-extracting file RPLKT1.EXE from the NOVLIB forum on CompuServe®. Configuring a remote-boot workstation is governed by the terms of your Novell license agreement.

As with all NetWare software used with Windows 95, you should make sure that you have the latest MS-DOS and Windows supporting files, including ODI drivers, network shell, LSL, and other required DLLs.

To prepare for RIPL support on the server, you must load and bind the Novell-supplied RPL.NLM file in AUTOEXEC.NCF and copy all .RPL files to the SYS:LOGIN directory.

To use RIPL to support a diskless workstation, the workstation must have an RPL ROM Module (PROM) installed on the network adapter that can send the correct RPL frame sequence. You must also create a disk image file in the server's SYS:LOGIN directory, as described later in this section.

For more information, see your Novell documentation; see also the Novell-supplied document, RPLNLM.DOC, and *IBM Remote Program Load User's Guide* from the NOVLIB forum on CompuServe.

Notice that some older PROMs (such as NE2000 boot PROMs) use only 802.3 Ethernet frame types; RIPL.NLM cannot run with this frame type and usually binds to the 802.2 frame type. Such older PROMs also cannot use BOOTCONF.SYS. For information about determining whether your site is using such older PROMs, and to find the software solutions, see the Novell-supplied document RIPLODI.DOC, available from the NOVLIB forum on CompuServe.

To allow a remote-boot workstation to start from a Novell NetWare server, the following actions must be completed:

1. Create a boot disk, and then create a disk image file using the boot disk.
Windows 95 Setup installs a new disk image file, as described later in this section.
2. Copy the remote-boot files to the server.
3. Create a BOOTCONF.SYS file on the server.
4. Install the Enhanced Remote Boot PROM on the network adapter.
5. Install the network adapter in the remote-boot workstation.
6. Add an entry for the workstation in MACHINES.INI, as described in [Technical Notes on MACHINES.INI and SETMDIR](#).
7. Connect the remote-boot workstation to the network.

Note Do not run RPLFIX.EXE or DOSGEN.EXE under Windows 95. These utilities are included with the Novell RIPL software. DOSGEN is used to create IMAGE.SYS (the disk image for startup) and NET\$DOS.SYS to support RIPL on MS-DOS-based computers.

If you want to customize the disk images further using the Microsoft RPLIMAGE utility, first you must set **SaveSUBboot=1** in the [Setup] section of MSBATCH.INF. The files to be included in the boot image will be saved in the SUBBOOT subdirectory under the machine directory. Then, use the RPLIMAGE utility that is included in the ADMIN\NETTOOLS\NETSETUP directory on the Windows 95 compact disc.

Important The RPLIMAGE utility creates a file name NET\$DOS.SYS that consists of all the files in the current directory. You must then move NET\$DOS.SYS from the machine directory to the server's SYS:\LOGIN directory.

You can use the following command-line parameters with RPLIMAGE.EXE to make a disk image of files and directories, including lower level directories:

```
rplimage [pathname1] [pathname2] [/t:n] [/n:n] [/sc:n] [/nf:n] [/fs:n] [/h:n] [/f:n] [/ss:n] [/e:n]  
[label:string] [/date:yyyy.mm.dd] [/time:hh.mm.ss] [/sort]
```

Parameters for Microsoft RPLIMAGE.EXE

Parameter	Description
/t	Specifies the number of tracks
/n	Specifies the number of sectors per track
/sc	Specifies the number of sectors per cluster
/nf	Specifies the number of FATs in the image
/fs	Specifies the size of FATs in sectors
/h	Specifies the number of heads
/f	Specifies one of the standard formats
/ss	Specifies the sector size in bytes
/e	Specifies the FAT type (12-bit or 16-bit)
/label	Specifies a volume label for the image
/date	Specifies the date to touch all files and directories
/time	Specifies the time to touch all files and directories
/sort	Sorts the image by <i>filename.ext</i> in ascending order

The following information describes how Windows 95 Setup installs a new disk image file. It also provides information to help you create a BOOTCONF.SYS file to support remote-boot workstations running a shared copy of Windows 95 from a NetWare server. For more information, see the Novell publication *Installing Enhanced Remote Boot PROMs on Novell Ethernet Network Interface Cards*. To obtain this document, contact your NetWare vendor.

When Windows 95 Setup is finished, it automatically creates a disk image on the server. This file contains a disk image of the RAM drive for the remote-boot workstation.

You can include the boot image filename plus the workstation's network address and node address in the BOOTCONF.SYS file on the NetWare server that is the repository for boot image files. BOOTCONF.SYS is stored in the SYS:LOGIN directory of the server, and is a text file that contains one record for each remote-boot workstation or group of workstations. Multiple workstations can be specified by using wildcards or question marks within the network address.

The following shows the format for each record in BOOTCONF.SYS. The parameters are defined later in this section.

```
0x[network_address,]node_address = image_filename.sys [ack] [frame=ff] [gns] [noack] [nogns] [noprotect] [notro] [protect] [ps=server] [tro] [wait time=sss]
```

Each record ends in a carriage return or linefeed character.

The NetWare server that contains the boot image files should have Novell RIPL.NLM loaded and bound to the appropriate network adapter. The following procedures summarize this process.



To load RPL on a NetWare 3.x or 4.x server

1. At the command prompt, type **load rpl**
2. Then type the following:
bind rpl to *board* [ack] [frame=*ff*] [gns], [nodefault], [protect], [ps=*server*], [tro], [wait time=*sss*]

The parameters for BOOTCONF.SYS records and for binding RPL are not case-sensitive. The parameters can be entered in any order, and can be separated by either commas or blank spaces. The following table briefly defines these parameters. For more information, see your Novell-supplied documentation on BOOTCONF.SYS.

Novell NetWare Parameters for BOOTCONF.SYS and BIND Commands

Parameter	Description
ack	Requires a per-frame acknowledgment so slower workstations can pace RPL when it sends frames in burst mode.
bind <i>board</i>	Binds RPL to a board configured for 802.2 frames. The board

can be specified by the name of the network adapter board number.

frame=ff	Configures RBOOT to use the following frame types: 802.2 (default), EII (Ethernet_II), or snap .
gns	Causes the workstation to use a Get Nearest Server request after RBOOT is downloaded. Use this parameter when the workstation should find a server other than the one containing RPL.
nodefault	Causes RPL to ignore remote-boot requests when the node address is not in BOOTCONF.SYS.
nogns	Overrides gns .
noprotect	Overrides protect specified with BIND.
notro	Overrides tro with BIND.
protect	Adjusts memory size in BIOS data area to reflect the amount of memory used by RBOOT, reducing available memory by 12K. Do not use unless absolutely necessary.
ps=server	Specifies that RBOOT attach to a preferred server other than the server where RPL is located.
tro	Causes the bootstrap program to perform This Ring Only Count Of 3 on all broadcast frames. Used in source routing environments.
wait	Specifies how many seconds (0000 to 665535) the workstation waits before selecting a Disk Image Name automatically, when multiple names are specified in BOOTCONF.SYS.
time=sss	

Server-Based Setup for Windows 95

Technical Notes for Shared Installations

This section presents some technical notes related to running a shared copy of Windows 95.

System Startup and Networking for Shared Installations

For shared installations, the first access to the network must occur in real mode. For shared installations that use a Windows 95 protected-mode network client, Microsoft real-mode networking (NET.EXE) is used for the first network connection, even for connecting to a NetWare network. After Windows 95 is loaded, the protected-mode drivers take over if the computer is configured to use a Microsoft protected-mode client such as Client for NetWare Networks.

Real-mode versions of NetBEUI and the IPX/SPX-compatible protocols are built into NET.EXE. Real-mode networking includes only the basic redirector; there is no support for mailslots or named pipes. Microsoft TCP/IP cannot be used until after the system loads and switches to protected mode.

The following briefly summarizes the software portion of the startup process for a computer that starts from a floppy or hard disk to run a shared copy of Windows 95 from a server. For a general description of the Windows 95 startup process, see [Setup Technical Discussion](#).

- IO.SYS starts and reads the Registry to determine whether the computer is running Windows 95 over the network.
- COMMAND.COM runs AUTOEXEC.BAT and NETSTART.BAT (if present), which starts the network.
- During the first real-mode network connection, the system asks for a user name and password, and then logs on the user. If the administrator configures AUTOEXEC.BAT for logon using a generic user name, the user is not prompted to type a name and password.
- The network connects to the shared Windows directory. For computers running Windows 95 protected-mode network clients with machine directories on the network, the network also connects to MACHINES.INI.
- IO.SYS starts Windows.
- If the computer is configured to run a Windows 95 protected-mode network client, the system completes the transition to protected-mode networking.

Because there is both a real-mode and protected-mode network logon, it is possible that the user will be prompted for logon information twice. To avoid this, you can configure the **net logon** statement in AUTOEXEC.BAT to use a generic user name, so that the user isn't prompted to enter information for the real-mode logon. To do this, use a statement in this format:

```
net logon generic_name password /y
```

Notice, however, that the network connection made during the original real-mode network logon remains throughout the work session, even when the system switches to protected-mode network components after the first connection. For example, if a generic login is used to make the first connection to \\NWSVR1\SYS, and in protected mode you subsequently log on under your own user name with a different logon server, the generic connection to \\NWSVR1\SYS still remains.

The following describes some configuration issues and hints related to the real-mode and protected-mode network logon:

- For Windows NT networks, you can make sure that the generic logon in real mode uses the same domain as the user's actual logon in protected mode. This avoids the connection problem altogether.
- For NetWare networks, if Client for NetWare Networks is configured to use the same preferred server as specified in the real-mode logon, Windows 95 automatically tries the same user name and password for protected-mode logon. If this is successful, the user will not see a second prompt for protected-mode logon.

Notice in all cases that for shared installations, if you make the user name and password the same for real-mode and protected-mode network logon and for Windows logon, the real-mode logon prompt always appears.

Technical Notes on MACHINES.INI and SETMDIR

MACHINES.INI is a file that lists, for each client, the location of the machine directory and other drive letters to connect. This file is stored on the server containing the shared Windows 95 files. The following shows the format of each entry in MACHINES.INI:

```
[Node_address]
sysdatapath=drive:\path
drive=\\server\share specified in sysdatapath
```

The *Node_address* section name is the 12-character address of the network adapter for a particular computer. You can find this address on NetWare networks by using the **userlist/a** command. On computers running Windows for Workgroups or Microsoft Workgroup Add-on for MS-DOS, you can find this address using the **net diag /s** command. If the node address you find is less than 12 characters long, you must add 0 (zero) characters at the front of the address. For example, if the node address is AA00578902, then the section name must be [00AA00578902].

The path defined in **sysdatapath=** must be a drive that is mapped to a drive letter in the same MACHINE.INI section.

In the following example, the machine directory is set to E:\DIR1\DIR2, and drives C, D, and E are set to network locations:

```
[00AA0051E4FB]
SysDatPath=e:\dir1\dir2
c=\\server1\share1
d=\\server2\share2
e=\\server3\share3
```

Note A section entry must be included in MACHINES.INI for each remote-boot workstation or floppy-disk computer in order for the computer to be started.

The **setmdir** command is used to set the machine directory for the computer and load the full Registry.

The floppy startup disk or disk image for shared installations contains only a mini Registry large enough to start the real-mode network. The startup disk for shared installations does not contain the information to find the machine directory, so that a single boot image on the network (or floppy startup disk) can be used to start several computers. The **setmdir** command solves this problem.

For computers running Client for Microsoft Networks and Microsoft Client for NetWare Networks, the **setmdir** command connects to the directory that contains the shared Windows 95 files and looks for MACHINES.INI. When the **setmdir** command finds the computer entry in MACHINES.INI, it switches the Registry APIs to point to the full Registry.

For computers that use real-mode networking clients, the **setmdir** command-line includes the path to the machine directory, rather than using MACHINES.INI. This is because the system has no guaranteed way of finding node addresses on other networks.

Parameters for SETMDIR

Parameter	Description
/V	Sets verbose mode, so information is displayed while the program is running.
/R:path	Sets the current Registry and environment variables to the specified path. For example, setmdir /R:d:\users\anniep does the following: <ul style="list-style-type: none"> • Sets the Registry to D:\USERS\ANNIEP\SYSTEM.DATA • Adds D:\USERS\ANNIEP to the path • Sets the following environment variables: <pre>comspec=d:\users\anniep\command.com</pre>

temp=d:\users\anniep
tmp=d:\users\anniep

Other Notes on Shared Installations

MS-DOS Mode is disabled.

When the user starts a program that runs in MS-DOS Mode, Windows 95 shuts down and uses real-mode MS-DOS to run the program. When the program quits, Windows 95 starts again. This mode is available as a last resort mode for compatibility with existing software. Computers that run a shared version of Windows 95 lose their network when Windows 95 shuts down. Because of the related problems, MS-DOS Mode is not available for computers running Windows 95 over the network. When a user tries to run a program in this mode, Windows 95 warns that the mode has been disabled.

Hot docking for network adapters is not supported.

When Windows 95 starts over the network, real-mode drivers control the network adapter. If the network adapter is a Plug and Play card, the driver is responsible for setting the card to the active state. (You can use the setup program provided with the card to do this.) Computers that run over the network do not support hot Plug and Play disconnects, because the operating system is on the network.

Users cannot log off and log on as a different user.

For another user to log on to a shared installation, the computer must be shut down and restarted.

Safe Mode startup always runs configuration files.

To perform a Safe Mode system startup for a shared installation, the network must be started, so IO.SYS always runs AUTOEXEC.BAT, CONFIG.SYS, and NETSTART.BAT. Information in the machine directory controls how and when to perform a Safe Mode startup.

Introduction

This chapter provides information about customizing Windows 95 and using login scripts for automated installation of Windows 95.

- [Custom Installations for Windows 95: The Basics](#)
- [Custom Installations of Windows 95: The Issues](#)
- [Customizing Windows 95 with Setup Scripts](#)
 - [Using Server-Based Setup to Create Custom Scripts](#)
 - [Using BATCH.EXE to Create Setup Scripts](#)
 - [Editing MSBATCH.INF for Custom Settings](#)
 - [Customizing Setup for Accessibility Requirements](#)
 - [Installing Other Software Using Custom Scripts](#)
- [Customizing Detection for NetWare Networks](#)
- [Running Custom Setup Scripts](#)
- [Customizing Windows 95 with WRKGRP.INI Files](#)
- [Customizing Windows 95 with Profiles and Policy Files](#)
- [Overview of Push Installations](#)
- [Using Login Scripts for Push Installation](#)
 - [Preparing a STARTUP.GRP File](#)
 - [Preparing Login Scripts for Push Installations](#)
 - [Setting Up a Windows NT Server for Push Installations](#)
 - [Setting Up a NetWare Server for Push Installations](#)
 - [Running Login Scripts for Push Installations](#)

Custom Installations for Windows 95: The Basics

You can use the Server-based Setup program, as described in [Server-Based Setup for Windows 95](#), to install source files and create setup scripts to automate all kinds of Windows 95 installations. After using Server-based Setup to create a basic setup script, you can use a text editor to customize setup scripts for your site.

You have several options for customizing Windows 95 when users install Windows 95 using source files on a server. The most basic options include the following:

- Create custom MSBATCH.INF files. The custom setup scripts contain predefined settings for all the options that can be specified during Setup, and can contain instructions for installing additional software.
- Create user profiles and system policies to customize the desktop and system settings, or to restrict users' abilities to change the configuration.

The following table compares the customization methods formerly used for Windows for Workgroups versus the methods prescribed for Windows 95.

Comparison of Customization Methods

Windows for Workgroups	Windows 95
SETUP.SHH to customize system settings	MSBATCH.INF settings
SETUP.INF to copy additional files or to force Setup options	MSBATCH.INF settings
CONTROL.INF to list incompatible TSRs or force selection of devices or network clients	NETDET.INI for NetWare TSRs; built into Setup for all others
APPS.INF to create PIFs for applications	APPS.INF (same format)
WRKGRP.INI to control workgroup membership	WRKGRP.INI (similar format, with a new entry for Windows 95 features)
[New.Groups] in SETUP.INF for custom program groups	System policies to customize the desktop contents
setup /p to restore program groups; manually copying .GRP files to restore desktop contents	GRPCONV.EXE to convert program groups or restore default menus, as described in Setup Technical Discussion
SYSTEM.INI, WIN.INI, or CONTROL.INI to modify system or desktop settings	For upgrades from Windows 3.x, custom settings are migrated; for the rare cases in which there is no equivalent in the user interface or in system policies, you can still modify INI files

After a setup script and other customization files are created, Windows 95 can be installed automatically by running Setup at each client computer, using the name of the setup script as a command-line parameter. Setup can be run from any of the following:

- A login script
- From server-based system management software
- From a batch file that contains the appropriate setup command line, distributed on floppy disk or by electronic mail

Custom Installations of Windows 95: The Issues

In Windows 95, you cannot modify the default INF files to customize the setup process or the final Windows 95 installation. Instead, Windows 95 provides more flexible, easier to use methods that rely principally on MSBATCH.INF and system policies to control installation options or manage the final configuration.

To take advantage of user profiles, the client computers must be running a 32-bit, protected-mode network client, such as Microsoft Client for NetWare Networks or Client for Microsoft Networks. Additional issues for using user profiles and system policies are described in [User Profiles and System Policies](#).

To take advantage of WRKGRP.INI for restricting workgroup choices, the file should be stored in the shared directory that contains the Windows 95 source files. For shared installations, WRKGRP.INI should be stored in the shared Windows directory on the server.

The following list summarizes the items that cannot be customized or the screens that cannot be skipped during Windows 95 Setup.

Setup Components That Cannot Be Skipped or Customized

Dialog box or message	Comment
MS-DOS Uninstall	This message appears if Setup detects MS-DOS Uninstall information on the computer. You cannot turn off this display or automate a response.
OS/2 Detected	This message appears if Setup detects that a version of OS/2 is installed on the system. You cannot turn off this display or automate a response.
Quit All Windows Programs	This message appears if Setup detects that other programs are running. You cannot turn off this display or automate a response. This message always appears if Setup is run using a Windows-based network management tool such as Microsoft Systems Management Server.
Not Enough Disk Space	This message appears if there is not enough hard disk space to support the specified installation type. You cannot turn off this display from a setup script. However, to avoid this message, start Windows 95 Setup using the setup /id switch. Caution Setup will fail during installation if it runs out of disk space.
Checking Your Hard Disk	This information message always appears. You cannot turn off this display, but no response is required.
Preparing Directory	This information message always appears. You cannot turn off this display, but no response is required.
Analyzing Your Computer	This information message always appears. You cannot turn off this display, but no response is required.

If **Express=1**, you cannot add parameters to override safe detection for network adapters, SCSI controllers, or sound cards. This means that if the software detection process in Setup does not find peripheral hardware that is actually installed on the computer, then Setup will not run hardware detection to install support. In such cases, the user will have to use the Add New Hardware option in Control Panel to install support after Setup is complete.

You can force installation of certain hardware when **Express=1** by adding specific entries in the [System] section to install support. Otherwise, specify **Express=0** in MSBATCH.INF, and then during Setup you can manually specify hardware detection in the Analyzing Your Hardware dialog box.

Customizing Windows 95 with Setup Scripts

You can specify custom settings for Windows 95 installations by creating a custom file in MSBATCH.INF format and using this setup script for installation. The default setup script is stored with the source files on the server. Custom setup scripts can be stored in users' home directories or in other central locations.

There are several ways to create a custom setup script:

- Use Server-based Setup (NETSETUP.EXE) to specify many custom settings
- Use Batch Setup (BATCH.EXE in the *Windows 95 Resource Kit* utilities) to specify most settings
- Create or edit a file in MSBATCH.INF format to specify all possible custom settings

These methods are described in the following sections.

Tip The *Windows 95 Resource Kit* utilities include generic setup scripts for a variety of cases. These scripts can be used as is or modified to automate Windows 95 Setup.

Using Server-Based Setup to Create Custom Scripts

You can use the Make Script button in Server-based Setup to create a default setup script. This option can only be used to create a setup script, not to edit an existing script. To edit an existing script, you must use a text editor, as described in [Editing MSBATCH.INF for Custom Settings](#).

To create a custom setup script using the Server-based Setup program

1. In Server-Based Setup, click the Make Script button.
2. In the Save As dialog box, specify the filename for this setup script, then specify the path where the script is to be stored, and click OK.

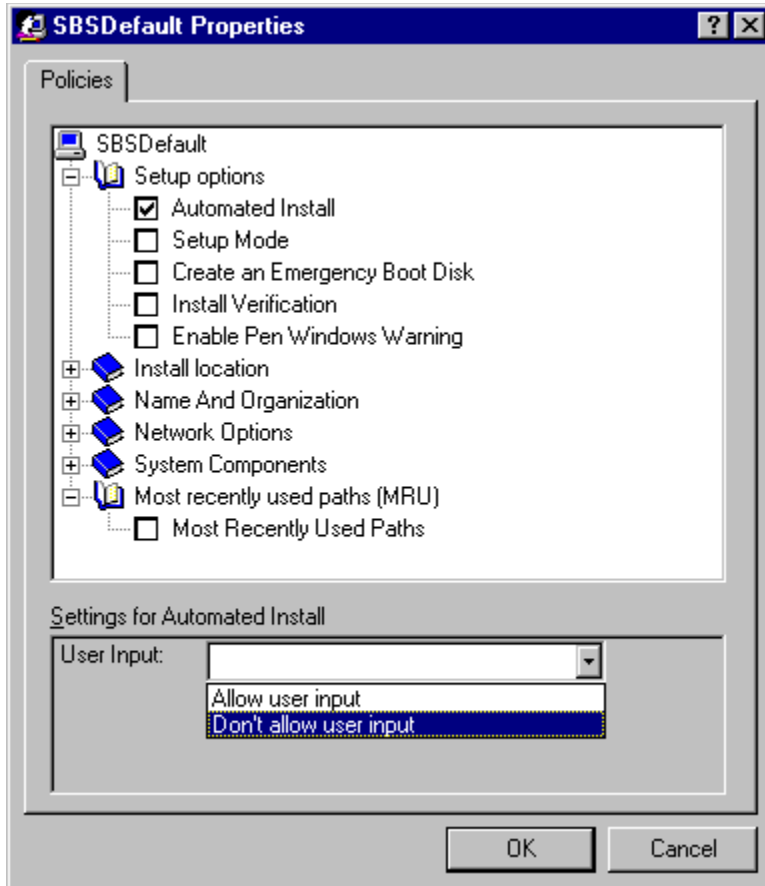

3. Use the SBS Default Properties dialog box to specify custom settings.

The following table summarizes what is set when a particular option is checked in the SBS Default Properties dialog box. For more information about each of these options when specified in a setup script, see [MSBATCH.INF Parameters](#).

Server-Based Setup Options for Custom Scripts

Option	Description and related script setting
Setup Options [Setup]:	
Automated Install	Specifies whether to allow user input during Setup; sets Express=1 .
Setup Mode	Selects Compact or Custom as the Setup type; sets the InstallType= value.
Create an	Ensures that Setup will create a startup disk; sets

Setup Options [Setup]:

Option	Description and related script setting
Automated Install	Specifies whether to allow user input during Setup; sets Express=1 .
Setup Mode	Selects Compact or Custom as the Setup type; sets the InstallType= value.
Create an	Ensures that Setup will create a startup disk; sets

Emergency Boot Disk	EBD=1 . The user will be prompted to insert a floppy disk when Setup is ready to create this disk.
Install Verification	Specifies full installation or verification only; sets the Verify= value: <ul style="list-style-type: none"> • Do a full installation • Verify install but don't copy files
Enable Pen Windows Warning	Ensures that a warning appears if Setup finds an unknown version of Pen Windows; sets PenWinWarning=1 .

Install Location [Setup]:

Install Directory	Specifies the path for where Windows 95 is to be installed; sets the InstallDir= value.
Server based Setup	Specifies where to install and how to start Windows 95. The Store Windows item offers two options: <ul style="list-style-type: none"> • On the server (for shared installations) • On the user's hard disk (for local installations) The Boot Device item offers three options that apply only for shared installations: <ul style="list-style-type: none"> • Floppy disk • Hard disk • Remote-boot server For information about shared installations of Windows 95, see Server-Based Setup for Windows 95 .

Name and Organization [NameAndOrg]:

Display name and organization page	Prevents the User Information dialog box from appearing during Setup; sets Display=0 .
Name	Specifies a user name; sets the Name= value.
Organization	Specifies a company name; sets the Organization= value.

Network Options [Network]:

Display network pages during custom setup	Prevents the Network Configuration dialog box from appearing during Setup; sets Display=0 .
Clients to Install	Specifies a comma-separated list of network clients to be installed; sets the Clients= value. <ul style="list-style-type: none"> • VREDIR installs Client for Microsoft Networks • NWREDIR installs Client for NetWare Networks • NETX or VLM retains existing Novell-supplied clients The first client in the list becomes the default client, which loads first when the computer is started.

Client for Windows Networks [VRedir]:

Validated Logon	Permits network logon only if the user has a valid account on the domain; sets ValidatedLogon=1 .
Logon Domain	Specifies a Microsoft network domain name; sets the LogonDomain= value.

Client for NetWare Networks [NWRedir]:

Preferred Server	Specifies a NetWare server name; sets the PreferredServer= value.
------------------	--

First Network Drive Specifies a drive letter; sets the **FirstNetDrive=** value.

Protocols [Network]:

Protocols to Install Specifies a comma-separated list to set the **Protocols=** value. The following values install the standard protocols provided with Windows 95:

- NWLINK indicates IPX/SPX-compatible protocol
- NETBEUI indicates Microsoft NetBEUI
- MSTCP indicates Microsoft TCP/IP

The first protocol in the list becomes the default protocol, which also sets LANA 0.

IPX/SPX-compatible protocol [NWLink]:

Frame Type Selects a frame type; sets the **FrameType=** value. The recommended setting for this is **Auto** unless you are absolutely certain of the frame type.

NetBIOS support Installs support for NetBIOS over IPX; sets **NetBIOS=1**.

Microsoft TCP/IP [MSTCP]:

DHCP Enables DHCP for configuring TCP/IP; sets **DHCP=1**.

IP Address Specifies an IP address for the computer in the form **###.###.###.###**; sets the **IPAddress=** value.

Subnet Mask Specifies a subnet mask in the form **###.###.###.###**; sets the **SubnetMask=** value.

WINS Specifies whether WINS servers are used for name resolution and how WINS is configured; sets the **WINS=** value. The following are the possible choices:

- Disable WINS
- Enable WINS; get parameters from DHCP
- Enable WINS resolution (you must type WINS addresses)

Primary WINS Specifies an IP address for a WINS server in the form **###.###.###.###**; sets the **PrimaryWINS=** value.

Secondary WINS Specifies an IP address for a WINS server in the form **###.###.###.###**; sets the **SecondaryWINS=** value.

Scope ID Specifies a scope ID string; sets the **ScopeID=** value.

Enable DNS Enables the use of DNS servers or LMHOSTS files for name resolution; sets **DNS=1**.

Hostname Specifies a host name for the computer (usually the same as the value of **ComputerName=**); sets the **Hostname=** value.

Domain Specifies the DNS domain name for this computer; sets the **Domain=** value.

DNS Server search order Specifies a comma-separated list of DNS servers in the order to be searched, each in the form **###.###.###.###**; sets the **DNSServers=** value.

Domain search order Specifies a comma-separated list of DNS domain suffixes; sets the **DomainOrder=** value.

LMHOST Path Specifies the path where the LMHOST file is stored; sets the **LMHostPath=** value. Notice that you must also check the Enable DNS option to use LMHOSTS.

Gateways Specifies a comma-separated list of gateways to be

used, each in the form **###.###.###.###**; sets the **Gateways=** value.

Net cards [netcard]:

Net cards to install Specifies a comma-separated list of network adapter driver names, which sets the **Netcards=** value.

Note In general, this value should not be defined in a setup script; you should let Windows 95 Setup use detection to identify and configure network adapters.

Services [Network]:

Services to install Specifies a comma-separated list of network services to be installed; sets the **Services=** value. For File and Printer Sharing services, specify one of the following values:

- VSERVER installs support for Microsoft networks
- NWSERVER installs support for NetWare networks

File and Printer Sharing for NetWare Networks [NWServer]:

SAP Browsing Enables SAP Advertising for this computer; sets **Use_SAP=1**.

Browse Master Enables Workgroup Advertising for this computer, and specifies the browser master role for this computer; sets the **BrowseMaster=** value. The following choices are possible:

- This machine can be a browse master
- This machine cannot be a browse master
- This machine is the preferred browse master

File and Printer Sharing for Microsoft Networks [VServer]:

LMAnnounce Allows computers running Microsoft LAN Manager to see this computer; sets **LMAnnounce=1**.

Browse Master Specifies the computer's browser master role; sets the **MaintainServerList=** value. The following choices are possible:

- Auto (the computer can be a browse master if required)
- Enabled (this computer is the browse master)
- Disabled (this computer cannot be a browse master)

Identification [Network]:

Computer Name Specifies a unique name on the network; sets the **ComputerName=** value.

Workgroup Specifies a unique name on the network; sets the **Workgroup=** value.

Description Specifies any string, with no commas; sets the **Description=** value.

Access Control [Network]:

Security Type Defines the type of security to be used to protect shared resources, and the type of pass-through security agent, if user-level security is specified; sets the **Security=** value. The following choices are possible:

- Share (for share-level security)
- User-level — Windows NT domain

- User-level — Windows NT computer
 - User-level — NetWare server
- Pass-through Agent Specifies the server or domain that is to provide pass-through validation for user-level security; sets the **PassThroughAgent=** value.

System Components [System]:

- Various device types Specifies the related INF section name for installing and configuring a specific device. This includes Advanced Power Management, locale, machine, pen windows, tablet, keyboard, monitor, display, and mouse devices.
- Note** The recommended method for installing and configuring all these devices is for Windows 95 Setup to use detection.

Most Recently Used Paths [InstallLocationsMRU]:

- Most Recently Used Path Specifies UNC names for up to four paths that can be displayed in dialog boxes that request the location of files during Setup.

Tip for Ensuring User Logon Capabilities in Setup Scripts

By default, Windows 95 Setup preserves the network identification information from the user's previous networking configuration, including the logon domain or preferred server. However, in cases where this configuration information is not already defined, you must specify settings in the setup script.

If users are installing Windows 95 from a server that requires logon validation, make sure the custom setup script defines the correct logon server. For a computer that will run Client for Microsoft Networks and use the Windows NT network for network logon validation, you should define values for **LogonDomain=** and **ValidatedLogon=** in the [VRedir] section. For a computer that will run Client for NetWare Networks, define a correct value for **PreferredServer=** in the [NWRedir] section.

If the appropriate values aren't defined in a setup script, the user might not have the validated access required to complete the final Setup steps for installing printers and other actions.

Custom, Automated, and Push Installations
 Customizing Windows 95 with Setup Scripts

Using BATCH.EXE to Create Setup Scripts

Batch Setup (BATCH.EXE) is a Windows-based program that makes it easy to create setup scripts that can be used to automate Windows 95 installation. By running Batch Setup and completing the options, you create a file in MSBATCH.INF format that can be used to run Windows 95 Setup with minimal user intervention.

This tool is especially useful when you are testing alternate configurations and need to run Setup repeatedly. Batch Setup can be used to define all options in a setup script; however, unlike Server-based Setup, it cannot be used to install source files or create machine directories for a shared installation.

The following summarizes the suggested method for running and using Batch Setup.



To use Batch Setup (recommended method)

- From the Start menu, click Run. Type **batch.exe** and then complete all the options to create a customized setup script.

For assistance in completing any options, see the online Help for Batch Setup.

After you create the setup script, you can run Windows 95 Setup by specifying the name of the script as a command-line parameter, as described in [Running Custom Setup Scripts](#). Depending on how many options you completed in Batch Setup, you might not have to provide any additional input while installing Windows 95.

For more information, see the BATCH.HLP and README.TXT files in the BATCH directory. For a description of the parameters in the file created by Batch Setup, see [MSBATCH.INF Parameters](#). If you want to modify the file that is created, follow the guidelines for editing setup scripts, as described in [Editing MSBATCH.INF for Custom Settings](#).

Editing MSBATCH.INF for Custom Settings

After you have used Server-based Setup or BATCH.EXE to create a setup script in MSBATCH.INF format, you can edit and save this file with a text editor to create alternate or more detailed setup scripts.



To edit MSBATCH.INF

1. Use a text editor such as Notepad to open the MSBATCH.INF file.
2. Edit the file, and save it in text-only format.

The following are the editing guidelines for MSBATCH.INF:

- Each section starts with a unique section name enclosed in brackets ([]).
- Only sections and key words defined in MSBATCH.INF Parameters, are evaluated by Windows 95 Setup.
- Each section can contain one or more entries. The typical entry consists of a key word and a value separated by an equal sign.
- Key words within a section do not have to be unique, but each key word and its value should follow the guidelines for that key word.
- A comment can be included anywhere on a line by starting the comment with a semicolon.

Tip for Defining Custom Entries in Setup Scripts

Use the Custom Setup option to install Windows 95 on a single computer. You can define all the optional components and other items you want installed for other similar computers at your site.

After Windows 95 is completely installed on this single computer, you can use any text editor to copy the [OptionalComponents], [Setup], [NameAndOrg], and [System] sections from SETUPLOG.TXT in the computer's root directory. Add this information to define settings for the same sections in the custom setup script.

This is especially useful for defining entries for [OptionalComponents] or when many computers require the same [System] settings. Some settings for the [Network] section can also be copied from SETUPLOG.TXT.

Customizing Setup for Accessibility Requirements

Users who require accessibility aids to work with Windows can experience problems with Windows 95 Setup, because their accessibility aids are not available while Setup is running.

As the system administrator, you can assist users in such cases by creating setup scripts that define all options so that Setup can run without user intervention. In such cases, be sure to include the Windows 95 Accessibility Options among the optional components to be installed with Windows 95.

The following suggestions can help individuals who require accessibility aids but do not have a system administrator to create a setup script. In such cases, you have two options, depending on whether you want to create the script while running Windows 3.x or MS-DOS:

- If you are running Windows 3.1 or Windows for Workgroups, use BATCH.EXE to create a setup script
- If you are running MS-DOS, create or edit the AUTOMATE.INF setup script provided with the *Windows 95 Resource Kit* utilities

When you install Windows 95 over an earlier version of Windows, Setup automatically moves your

Startup group and other Program Manager groups for use under Windows 95. So any accessibility options in your previous Startup group will start automatically under Windows 95 after Setup is completed.

Whichever method you choose for creating the script, you can use it to control Windows 95 installation automatically, by using it with the **setup** command, as described in [Running Custom Setup Scripts](#). For information about the accessibility options that can be installed automatically with Windows 95, see [Accessibility](#).



To use Batch Setup to create a hands-free setup script

1. Run Batch Setup, as described in [Using BATCH.EXE to Create Setup Scripts](#).
2. In the Windows 95 Batch Setup window, type the Setup Identification information.
3. Click the Installation Options button.
4. In the Windows 95 Installation Options dialog box, click the Type Of Installation list and select Custom.

You can make any other changes you want. However, the recommended method is to accept all the default settings and let Windows 95 Setup complete the actions automatically.

5. Click the Set button.
6. In the Batch Setup Administrative Options dialog box, make sure the option named Don't Stop During Setup is selected. Then click OK.
7. In the Windows 95 Batch Setup window, click the Optional Components button.
8. In the Available Areas list in the Windows 95 Optional Components dialog box, click Accessories. Then in the Available Components list, click Accessibility Options so that it is checked.

You can use the same method to add any additional components to be installed with Windows 95. Then click OK.

9. When you finish setting all the options you want, click the Done button. In the Save As dialog box, specify the path and filename for saving this script.

For networking components, the recommended method is to allow Windows 95 Setup to install and configure components automatically.



To edit AUTOMATE.INF to create a hands-free setup script

1. Use any text editor to edit a copy of the AUTOMATE.INF sample script provided in the SAMPLES directory with the *Windows 95 Resource Kit* utilities. You can also create this script by typing the entries in the sample script following this procedure.
2. Change entries to specify your correct time zone, product identification number, and user name. To make these changes, delete the semicolon at the start of the line, and type the correct text between quotation marks.

For a list of correct values for time zones, see [MSBATCH.INF Parameters](#).

Your product identification number is the CD Key number on the Windows 95 compact disc case or the number provided on your Certificate of Authenticity.

3. Under the [Optional Components] section, include this entry:

```
"Accessibility Options"=1
```

The following shows an example of the entries defined in AUTOMATE.INF:

```
[Setup]
Express=1
InstallType=1
EBD=0
;TimeZone=""           ;remove semicolon and add correct zone in quotes
;productid=""         ;remove semicolon and type the product ID
vrc=1                 ;overwrite files without warning you

[NameandOrg]
Display=0
```

```
Name="" ;type your username between the quotes
```

```
[Network]  
Display=0
```

```
[OptionalComponents]  
"Accessibility Options"=1  
; add any other components to be installed in this section
```

Installing Other Software Using Custom Scripts

This section describes how to use INF Installer to prepare for installing other software with Windows 95 and how to add Run-Once actions that occur at the end of Setup.

Server-based Setup cannot be used to add extra components, such as *Windows 95 Resource Kit* utilities or applications and services from the ADMIN directory on the Windows 95 compact disc. To add such components or to add any other software that uses Windows 95 INF files, you must make sure that the source files are installed correctly, the INF files used by Windows 95 Setup are modified properly, and correct entries are added to MSBATCH.INF.

The INF Installer utility (INFINST.EXE) accomplishes these actions automatically for any software that has a Windows 95 INF file. INF Installer is part of the *Windows 95 Resource Kit* utilities. Before you can use INF Installer, you must use Server-based Setup to install the Windows 95 source files in a network directory, as described in [Server-Based Setup for Windows 95](#).



To use INF Installer to add components in MSBATCH.INF

1. From the Start menu, click Run, and then type **infinst**
2. In the INF Installer window, click the Set Path button and type the UNC path name for the Windows 95 source files on the network.
3. To add a component's INF and other files to the Windows 95 source files, click the Install INF button, and then browse for the path name for the current location of the component's INF, executable, and supporting files.

INF Installer copies the files listed in the component's INF file and makes the following modifications in the MSBATCH.INF file that's in the Windows directory on the server that contains the Windows 95 source files:

- If the component is a network service, then the device ID as specified in the INF file is added to the **services=** entry in the [Network] section.
- If the component is an application, the components listed in the INF file are added as comments in the [OptionalComponents] section.

Note For any component to be installed using this setup script, you must manually remove the semicolon before the entry for the component name.

If you want to add to the Run-Once operations that occur the first time Windows 95 starts, you can define entries for these actions in MSBATCH.INF. In addition, you must make sure that the required files are available with the Windows 95 source files, or are otherwise available on a shared resource that users installing Windows 95 have access to. For software components that have Windows 95 INF files, you can use INF Installer to prepare files to be included with Windows 95 Setup. You must also add these entries in the setup script:

- Create an **AddReg=** entry in the [Install] section for each software component that you want to run during the Run-Once part of Setup. For example:

```
[install]
AddReg=myprogram.addreg
```

For more examples of [Install] section entries, see [MSBATCH.INF Parameters](#).

- In the related [*software*] section, add the following kind of entry for the operation:

```
[myprogram.addreg]
HKLM, Software\Microsoft\Windows\CurrentVersion\RunOnce\reg_values
```

The following shows the Run-Once entry from MSMAIL.INF that causes the setup routine for Microsoft Mail to run after Windows 95 is installed:

```
[MSMailAddReg]
HKLM, Software\Microsoft\Windows\CurrentVersion
\RunOnce\Setup, "%EmailRunOnce%", , "%25%\mlset32.exe"
```

Important To create definitions in MSBATCH.INF for Run-Once statements or other actions, you must provide the precise Registry settings that the program uses to read or write to the Registry. This requires programmatic understanding of the software, or you must use values provided by the software manufacturer.

If you want to add other software as part of Windows 95 installation, but that software does not have a Windows 95 INF file, you must use a system management tool for software distribution, such as Microsoft Systems Management Server.

Tip Avoid using relative path names in setup scripts so that you can make sure the commands are run from the correct directory.

Customizing Detection for NetWare Networks

This section describes the format of NETDET.INI, which is used to detect NetWare components and TSRs during Windows 95 Setup. You can use this information to add custom entries for detecting components on NetWare networks and defining actions to be taken during Setup based on detection results.

Note If you do not need to modify the default detection behavior for setting up Windows 95 on NetWare networks, you can skip this section.

The NETDET.INI and related NETOS.DLL files are stored in the PRECOPY2.CAB file on the Windows 95 floppy disks or compact disc. The version used by Windows 95 Setup is stored in the Windows directory on the local computer. If you modify this file, you can place the revised version of NETDET.INI in the Windows directory on the server that contains the Windows 95 source files.

Each component section in NETDET.INI consists of one or more *detection* entries, and one or more *event* entries. A detection entry has the following format:

```
detectionN=method1[,method2...]
```

Alternate *detection* entries can be used to define different actions to be taken, depending on how a component is detected. For example, a TSR detected in memory but not in a batch file might require different actions from the actions required when an entry for the TSR is found in AUTOEXEC.BAT. For example:

```
detection0=mcb
detection1=autoexec.bat
full_install0=migrate
full_install1=prevent
```

Each *method#* parameter in the *detection* statement defines a detection method, as listed in the following table. Setup assumes that the component has been detected if one method detects it.

Detection method	Meaning
assumed	Always detected; used to force an action unconditionally
autoexec.bat	Detected in an uncommented line in AUTOEXEC.BAT
config.sys	Detected in an uncommented line in CONFIG.SYS
custom_dll	Detected by calling external DLL detection code
mcb	Detected by checking the list of TSRs maintained by MS-DOS in the memory control blocks (MCB)
mcb_nobat	Detected in the MCB chain but not in AUTOEXEC.BAT
system.ini	Detected in an uncommented line in SYSTEM.INI

The special detection method **custom_dll** requires two additional entries: **detection_dll**, which contains the filename of the DLL to be loaded, and **detection_call**, which contains the name of the entry point consistent with the following **typedef**:

```
typedef BOOL (WINAPI *LPDCALL) (LPSTR)
```

Adding custom entries based on this detection method requires that you have sufficient programmatic understanding of the calls made in the relevant DLLs. For an example of required entries for **custom_dll**, see the example entry for VLM later in this section.

The NETDET.INI file includes one or more *event* entries grouped by numerical suffixes that match the suffixes in *detection* entries (that is, *N* must be 0 or 1). Each *event* entry contains a list of actions to be performed if the associated *detection* action was successful. The following shows the form of *event* entries:

eventN=action1[(parameter)],action2[(parameter)]...

The *event* name is the name of the Setup code for handling installation of components related to the detected TSR or NetWare component. The following list shows the defined events.

Event	Meaning
protstack_installN	The protected-mode protocol will be installed
nwredir_installN	The protected-mode network client will be installed
full_installN	The protected-mode protocol and network client will be installed

The following table lists the defined action codes related to events in NETDET.INI.

Action code	Meaning
none	Do not do anything (NOP)
prevent	Recommend against using during recommendation phase
remove	Comment out using REM in AUTOEXEC.BAT or a batch file called from AUTOEXEC.BAT
unremove	Remove REM comment from AUTOEXEC.BAT or a batch file called from AUTOEXEC.BAT
migrate	Comment out using REM in AUTOEXEC.BAT, and add to WINSTART.BAT
unmigrate	Remove REM comment in AUTOEXEC.BAT, and remove from WINSTART.BAT
install_devnode(<i>node</i>)	Cause specified device node to be installed
uninstall_devnode(<i>node</i>)	Cause specified device node to be removed
gen_install(<i>section</i>)	Cause action in an <i>install</i> section to run (see the example for Source Routing for NetWare later in this section)

Notice that the event named **prevent** is a special case that is used during the recommendation phase when Setup is determining which new Windows 95 components can be installed without interfering with TSR dependencies defined in NETDET.INI. If a component is detected by the defined method and the **prevent** action is associated with the related event, then Setup will recommend against the usual Setup action for the event.

The following shows some examples of entries in NETDET.INI:

```
;;;;; VLM 4.x ;;;;;;;;;;
; prevents installation of Client for NetWare Networks
; if Novell NDS is used
[VLM]
detection0=custom_dll
detection_dll=NETOS.DLL
detection_call=NW_IsNDSinUsefull_install0=prevent

;;;;; Btrieve ;;;;;;;;;;
[Brequest.exe]
detection0=mcb; installs all protected-mode components
full_install0=migrate; if Btrieve is present

;;;;; NOVELL NETBIOS ;;;;;;;;;;
; installs NETBIOS over IPX if Novell NETBIOS is present
[NETBIOS]
detection0=mcb
full_install0=remove,install_devnode(NWNBLINK)
```

```
;;;;;;;;;; SOURCE ROUTING FOR NETWARE ;;;;;;;;;;
; adds cache size for Source Routing
[ROUTE]
detection0=mcb
full_install0=remove,gen_install(NWSRCR)

[NWSRCR]
AddReg=NWSRCR.reg

[NWSRCR.reg]
HKLM,System\CurrentControlSet\Services\VxD\NWLINK,cachesize,, "16"
HKLM,System\CurrentControlSet\Services\VxD\NWLINK\Ndi\params
  \cachesize,"", "16"
```

Running Custom Setup Scripts

The following procedure describes how to run Windows 95 Setup from a setup script.



To run Windows 95 Setup using a setup script with minimal user action

1. Start the computer running the existing network client software.
2. Connect to the server or drive that contains the Windows 95 source files.
The network administrator can include this step in the login script to avoid user action.
3. Change to the directory where the Windows 95 Setup files are located.
4. At the command line, run Windows 95 Setup by specifying the batch file that contains the setup script, using this syntax:

```
setup msbatch.inf
```

If MSBATCH.INF exists in the Windows directory on the server containing the Windows 95 source files, Setup uses it by default. Otherwise, for example, you would type **setup e:\mybatch.inf** to run Setup using a setup script named MYSCRIPT.INF on drive E. To use a script in the SCRIPTS directory on a server named NTSVR1, you would type **setup \\ntsvr1\scripts\mybatch.inf** (provided, of course, that your operating system software can interpret UNC path names).

-Or -

Include the entire statement for running Windows 95 Setup in the login script, so that the user does not have to type anything at the command prompt.

When you run Windows 95 Setup in this way, Setup takes all settings from the custom script. For information not defined in the setup script, Windows 95 Setup migrates settings from an earlier version of Windows 3.x on the computer, uses built-in defaults, or prompts the user to provide information.

After copying files, Windows 95 Setup restarts the computer and begins the Run-Once setup operations (printer setup, program group conversions, and so on). When these operations are finished, Windows 95 is completely installed.

When the user quits Windows 95 Setup at this point, Setup writes all changes to the Registry. The user can restart the computer and log on with the usual logon name and password.

The network administrator can automate this process by providing each user with a floppy disk that contains the necessary files for starting the computer, connecting to the network, and running Windows 95 Setup with a custom setup script.

Customizing Windows 95 with WRKGRP.INI Files

You can use a file named WRKGRP.INI to specify a list of workgroups that users can choose to join. You can use WRKGRP.INI in these ways:

- To help reduce the proliferation of workgroup names on the network
- To control the workgroup choices that users can make
- To specify defaults for the NetWare preferred server or Windows NT domain on a per-workgroup basis

The WRKGRP.INI file is stored in the Windows directory on the server that contains the Windows 95 source files.

Windows 95 Setup uses the values defined in WRKGRP.INI to set Registry values in the workgroup, logon domain, preferred server, and other values. The same values are used to control options available for users to select in the Network option in Control Panel. The WRKGRP.INI file contains the following sections:

- [Options] specifies the recognized options for workgroups
- [Workgroups] contains a list of workgroups from which the user can choose

In Windows 95, for each workgroup, you can specify the domain, preferred server, and so on, that everyone in a workgroup will use, depending on the network providers used.

The following table describes the format of the Windows 95 WRKGRP.INI file.

WRKGRP.INI Settings

Section or entry	Description
[Options] section:	
ANSI=true false	Specifies whether the workgroups need to be converted from an OEM character set to ANSI. Default is false .
Required=true false	Specifies whether users can type their own workgroup name or forces them to choose from those listed.
ForceMapping=true false	Specifies whether users can change the workgroup, logon domain, or preferred server that are set by a mapping.
Mapping=NP1, NP2, NP3,... (comma-separated list of network providers)	Specifies a comma-separated list of the network providers to which workgroups can be mapped. Also specifies the order in which values will be listed in the [Workgroups] section. Implicitly, this specifies where in the Registry to store settings. This parameter is optional. By default, workgroups map to <i>domain</i> , <i>preferred server</i> .
Default=NP1 default, NP2 default, NP3 default,...	Specifies the default mapping for workgroups listed in the [Workgroups] section that don't have a mapping defined. This allows you to add a single entry to an existing Windows for Workgroups WRKGRP.INI file to get minimal mapping functionality. The format is the same as for specifying a mapping in [Workgroups].
[Workgroups] section:	
workgroup=optional_mapping	Specifies a workgroup that users can

choose and its mappings will automatically be defined in the order specified in **Mapping=**. There can be a *workgroup=* entry in the file for every workgroup that users can choose. Each name of a workgroup must be followed by an equal sign (=) for the workgroup name to be interpreted correctly.

The entry that defines the network providers for each workgroup has the following format in the [Workgroups] section:

```
workgroup_name=mapping1,mapping2,mapping3,...
```

By default in Windows 95, workgroups can be mapped to both Windows NT domains and NetWare preferred servers. (This is because Windows 95 includes network providers for these two networks.) For example:

```
MktMain=MktDom1,master1
```

This example specifies that the workgroup named MktMain has these two mappings: MktDom1 is the logon domain for the Windows NT network, and Master1 is the preferred server for the NetWare network.

Administrators can specify the 32-bit, protected-mode network providers that can be mapped for a workgroup by setting the **Mapping=** parameter in the [Options] section of WRKGRP.INI. For example, if the network uses two network providers (MSNP32 for Microsoft networks and NWNP32 for NetWare networks), the following is defined in WRKGRP.INI:

```
[options]  
mapping=msnp32,nwnp32
```

The order specified in the **Mapping=** entry also specifies the order of items in the [Workgroups] section.

You can also use the **Default=** entry to specify a default mapping for workgroups that do not have an explicit mapping. This allows you to use an existing WRKGRP.INI created for Windows for Workgroups 3.11, and add one entry to take advantage of Windows 95 functionality. For example, add the entry **Default=MktDom1,Master1** to use the servers described in the previous example as the default mapping.

If a WRKGRP.INI exists, the Workgroup field in Windows 95 Setup and the Network option in Control Panel both show all the workgroups listed in WRKGRP.INI. Users can choose a workgroup from the list or type a workgroup name. If **Required=true** in WRKGRP.INI, the user must choose from the list.

In WRKGRP.INI, **ForceMapping=** controls whether mapped values can be changed in the Windows 95 user interface. For example, if **ForceMapping=true** and the user selects a workgroup that is mapped to a domain, the user cannot change the value in the Logon Domain box in the Network option in Control Panel and in the logon dialog box.

Note If Windows 95 Setup finds the WRKGRP.INI file in the Windows 95 source files, it copies the file to the shared Windows directory.

Customizing Windows 95 with Profiles and Policy Files

You can predefine settings in user profiles and system policy files to control user actions. For example:

- You can enforce a mandatory desktop configuration by installing a mandatory user profile (USER.MAN) in users' home directories. (On NetWare networks, this is the MAIL subdirectory for each user.)
- You can control the user's security privileges, network access, and desktop configuration if you install system policy files on the logon server. This is the PUBLIC directory on a NetWare server or the NETLOGON directory on the primary domain controller for a Windows NT domain.

To take advantage of these features in Windows 95, you must define the user profile and system policy settings to be used. Then place these files in the appropriate directories before users run Windows 95 Setup. When users log on to Windows 95, the profiles and policies will be used automatically.

For information about creating and using user profiles and system policy files, see [User Profiles and System Policies](#). For an example of setup script statements that enable user profiles, group policies, and remote administration, see [MSBATCH.INF Parameters](#).

Overview of Push Installations

A push installation uses Windows 95 Setup with a setup script, plus login scripts and user accounts on a NetWare or Windows NT network, to create an automated, mandatory installation scheme for installing Windows 95 on multiple computers. This allows you to install Windows 95 remotely, without actually going to the computer being upgraded.

You will probably want to create an automated push installation scheme if you are responsible for installing Windows 95 on more than 50 computers.

After you use Server-based Setup to set up the source files on one or more servers and create setup scripts, you can perform push installations in these ways:

- Use a login script that includes a statement to run Setup with a setup script, automatically installing Windows 95 when each user logs on. Details are provided in the following sections.
- Insert an object in an electronic mail message that will start Windows 95 Setup with a setup script when the user clicks the object.
- Use Microsoft Systems Management Server to run Windows 95 Setup with a setup script as a mandatory job, as described in [Microsoft Systems Management Server](#).
- Use network management software from other vendors to install Windows 95 based on the setup scripts you create. Refer to the documentation for your network management software for information about performing remote installation of software.

Push installation example for migration of shared Windows 3.x.

Because Windows 95 installation and management methods differ significantly from Windows 3.x, it might be helpful to look at an example of how one type of corporate installation can make the move to Windows 95. The following example focuses on migrating shared installations to Windows 95.

In the corporation in this example, Windows 3.x was installed in shared directories on the network (using **setup /a**). Workstations each contain a hard disk, where the swap file, TEMP directory, and hardware-specific SYSTEM.INI file are stored. Windows 3.x components were installed in each user's home directory. All workstations run NetWare real-mode networking with ODI drivers. When users log on to the network, the login script runs WINSTART.BAT, which copies the workstation's SYSTEM.INI to the user's home directory and starts Windows. All applications are also stored on and run from servers.

To migrate to Windows 95 using push installations that maintain similar functionality for users on shared installations, the administrator does the following:

1. Install Windows 95 source files and create machine directories for each computer. This step includes using INF Installer to prepare any supporting software that uses Windows 95 INF files, and manually copying any additional networking or applications software to the shared Windows 95 directory on the network.
2. Create the setup script that specifies any custom settings. This should include installing all protected-mode networking components, so that both the administrator and user can take advantage of Windows 95 protected-mode networking features.
3. Create system policies, including setting policies that enable user profiles.
Alternately, you can enable user profiles using setup script statements, as defined in [MSBATCH.INF Parameters](#). This is the only method for enabling group policies.
4. At each client computer, run a login script with statements to do the following:
 - Copy the contents of the user's home directory to C:\WINDOWS.
This should include copying the Windows 3.x .GRP, .INI, and REG.DAT files that define the user's personal preferences and working environment. In this case, make sure that the Windows 3.x REG.DAT file includes registration settings for all the shared applications that users run at your site.

Note This process is related to the particular configuration used in the example; this is not a required process for creating shared installations or using push installation methods to install Windows 95.

- Run Windows 95 Setup with a custom setup script.

You can set **installdir=c:\windows** to define the machine directory in the setup script.

In this example, Windows 95 Setup installs the shared Windows 95 files on the local hard disk and in the machine directory for the client computer. The settings in the Windows 3.x .GRP, .INI, and REG.DAT files are migrated automatically to the Registry. Notice that in this case, where user profiles are enabled, the current version of USER.DAT file is also stored automatically in the user's home directory when the user logs off. This copy of USER.DAT is the user profile that is then copied to the current machine directory wherever the user logs on.

To install Windows 95 on the local hard disk of client computers, the steps for the administrator are similar to those in the preceding example. However, no machine directories are created for the computers. The following section discusses specific issues related to login scripts for local installations of Windows 95.

Using Login Scripts for Push Installation

Push installation from login scripts can be used on computers running MS-DOS or Windows 3.x with the following real-mode network clients:

- Microsoft Workgroup Add-on for MS-DOS
- LAN Manager 2.x real-mode network client
- Novell® NetWare® real-mode network client (NETX or VLM)
- Windows for Workgroups real-mode and protected-mode network clients

The following sections describe how to use a common Upgrade account rather than changing every user's login script to install Windows 95. This method avoids activating the Setup process again after Windows 95 has been installed. However, using a common Upgrade account might not work in some corporate environments, where INI files are copied to users' directories based on the user name specified at logon. In such cases, if Windows 95 is installed using an Upgrade account, each user's application settings will not be migrated to Windows 95. In such cases, you can add statements to setup scripts to copy the related INI files to C:\WINDOWS as part the installation process.

Other methods you can use with login scripts to avoid the problem of running Setup a second time include adding a statement to the login scripts to check the MS-DOS version with alternate actions defined when the version is Windows 95.

To use the method described in this section for push installations (for either protected-mode or real-mode network clients), you must do the following in addition to installing the Windows 95 source files and creating setup scripts:

- For Windows for Workgroups computers, create a STARTUP.GRP file that contains the command line for starting Windows 95 Setup, as described in [Preparing a STARTUP.GRP File](#).
- Create the login scripts that will be used to start the installation process.
- Create the special user accounts that will be used to run the login scripts.

A push installation actually begins when the user logs on to the client computer.

Important If the login script processor stays in memory after starting Windows 95, and if the computer is not correctly configured to use extended memory, then there might not be sufficient memory available to run Setup. However, the method presented here for using a STARTUP.GRP file with Windows for Workgroups avoids memory problems in push installations. For login scripts on NetWare networks, you can use an exit command that runs Windows 95 Setup after the login script is complete.

You can also remove unnecessary TSRs and device drivers to increase the available memory before Setup begins. For information about how to define statements in a setup script for changing the system configuration as part of installation, see [MSBATCH.INF Parameters](#).

Preparing a STARTUP.GRP File

If you are upgrading computers that run Windows for Workgroups, you can create a special Startup group that is used just once to run the login script.

The use of the Startup group is only mandatory when the user is running Windows for Workgroups 3.11 with logon validated performed by Windows NT Server. In this case, the user starts Windows for Workgroups, which loads the protected-mode protocols and processes the login script. The login script runs in a VM; although Windows 95 Setup cannot be run in a VM, the login script can be used to create a modified STARTUP.GRP file that causes Setup to run as a Windows-based application after the login script finishes running.

Note For computers that use a real-mode network client, login scripts can run Windows 95 Setup directly, without using a special STARTUP.GRP.

Only computers that use a protected-mode network client need to use the STARTUP.GRP method to run Setup from within Windows for Workgroups.



To prepare for push installations to upgrade earlier versions of Windows

1. Run Windows for Workgroups on a computer.
2. If the Startup group is not present, use the File New command in Program Manager to create a Startup group.
3. In the Startup group, use the File New command to create an Upgrade icon that contains the following command line:

```
source_drive:setup [source_drive:msbatch_format.inf]
```

If the setup script is named MSBATCH.INF and is in the Windows directory in the source files, you do not need to specify the script name on the command line. Otherwise, specify the drive and script name. For example:

```
k:\setup k:\myscript.inf
```

Specify the same source drive used in the login script statements, as described in the following sections on preparing the server for push installations.

4. Copy the STARTUP.GRP file to the shared directory on the server that contains the Windows 95 source files.
5. Delete the group or icon that you just created, so that it is no longer stored on the computer where you are working.
6. In the MSBATCH.INF file, add the following statements to make sure that STARTUP.GRP is replaced after Setup:

```
[install]  
renfiles=replace.startup.grp
```

```
[replace.startup.grp]  
startup.grp, startup.sav
```

```
[destinationdirs]  
replace.startup.grp=10
```

Preparing Login Scripts for Push Installations

This section presents some information about creating login scripts that use an Upgrade account for installing Windows 95 on client computers. Some of the login script statements described in this section are related to using the STARTUP.GRP file for Windows for Workgroups, as described in [Preparing a STARTUP.GRP File](#).

Tip Avoid using relative path names in login scripts and setup scripts so that you can ensure the commands are run from the correct directory.

Also, for shared installations, after Windows 95 Setup is complete, make sure that all path statements in users' login scripts point to Windows 95, and not Windows 3.x or MS-DOS directories.

Login scripts for Microsoft real-mode network clients.

For a computer running MS-DOS or Windows 3.1 with a Microsoft real-mode network client, the login script should be similar to the following:

```
net start full
net use drive_letter: \\server\distshare
drive_letter:setup drive_letter:msbatch.inf
```

If the client computer is running on a LAN Manager or Windows for Workgroups network, the login script must contain a **net start full** statement. On a Windows for Workgroups network, the real-mode network client for Windows for Workgroups or Windows 3.1 also requires the entry **lmlogon=1** in the [Network] section of SYSTEM.INI. This ensures that the full network redirector is loaded and the user is validated for network logon. Other login script issues are discussed in the following section.

Login scripts for Windows NT networks.

For client computers running MS-DOS or Windows 3.1 on a Windows NT network where an Upgrade account is to be used to install Windows 95, the login script must contain the following kinds of entries:

```
net use source_drive \\ntsvr\share
source_drive:setup source_drive:msbatch.inf
```

If this login script will be used to upgrade computers that are currently running Windows for Workgroups, the login script must contain the following kinds of entries to use a STARTUP.GRP:

```
net use source_drive \\ntsvr\share
rename windowsdir\startup.grp *.sav
copy path\startup.grp windowsdir\startup.grp
```

Value	Description
<i>Source_Drive</i>	Maps a drive letter for the server containing the source files. This must be the same drive letter as specified in the STARTUP.GRP file. Check the lastdrive= setting in CONFIG.SYS to make sure that the drive letter specified on the preceding command line is a valid logical drive letter. If it is not, the network connection will not be made, and the Setup process will fail.
<i>\\NTSvr\Share</i>	Specifies the Windows NT computer that contains the Windows 95 source files.
<i>WindowsDir</i>	Specifies the relative path to the user's Windows directory.
<i>Path</i>	Specifies the path to the Startup group file.
<i>User_Windows</i>	Specifies the relative path to the user's Windows directory that will contain STARTUP.GRP. Use the

relative drive and directory designation (.) instead of the actual path to the Windows directory (for example, C:\WINDOWS). Do not use the **WinDir** environment variable, because **WinDir** is not an accessible environment variable in the script.

For example, for a computer running Windows for Workgroups, the login script could be similar to the following:

```
net use k: \\ntsvr1\share1
rename .\startup.grp *.sav
copy \winnt\system32\repl\import\scripts\startup.grp .\startup.grp
exit
```

Login scripts for NetWare networks.

The login script for client computers running MS-DOS or Windows 3.1 must contain the following kinds of entries:

```
attach nwsvr/share:
map source_drive:nwsvr/share
source_drive:setup source_drive:msbatch.inf
```

Value	Description
<i>Source_Drive</i>	Specifies the same drive letter as specified in the Startup group
<i>NWSvr/Share</i>	Specifies the NetWare server that contains the Windows 95 source files

For example, for a computer running MS-DOS or Windows 3.1 with a real-mode network client, the login script could be similar to the following:

```
attach nwserver1/win95
map k:nwserver1/win95
k:setup k:msbatch.inf
```

Setting Up a Windows NT Server for Push Installations

This section summarizes the procedures for running login scripts from a Windows NT server for push installations.



To prepare the server for push installations on a Windows NT network

1. Run Server-based Setup, and install the Windows 95 source files in the shared directory on the Windows NT Server, as described in [Server-Based Setup for Windows 95](#).
2. Create an MSBATCH.INF file to meet your installation requirements, and copy this file into the Windows 95 source directory on the server.
3. Using User Manager for Domains on a computer running Windows NT Server, create a user account named Upgrade, and specify **upgrade** as the password. Also, make sure the following options are selected for the Upgrade user account:
 - User Cannot Change Password
 - Password Never Expires

By default, the user account is created in the domain where you logged on to the network. To create the user account in another domain, you must select that domain before creating the account. If your users log on to multiple domains, create the Upgrade user account in each domain.

4. Create the login scripts that run Windows 95 Setup. For examples that use the Upgrade user account, see [Preparing Login Scripts for Push Installations](#).
5. Assign the login script to the Upgrade user account. The login script must be placed in the *winn\SYSTEM32\REPL\EXPORT\SCRIPTS* directory on the computer running Windows NT Server. The replication service replicates this from the export server to the import server, so the file is copied to *winn\SYSTEM32\REPL\IMPORT\SCRIPTS* on the server.

Setting Up a NetWare Server for Push Installations

This section summarizes the procedures for running login scripts from a NetWare server for push installations.



To prepare the server for push installations on a NetWare network

1. Run Server-based Setup, and install the Windows 95 source files in the shared directory on the NetWare server, as described in [Server-Based Setup for Windows 95](#).
2. Create an MSBATCH.INF file to meet your installation requirements, and copy this file into the directory that contains the Windows 95 source files on the network.
3. On the NetWare server, create a user account named Upgrade and specify **upgrade1** as the password. Also, set the types of options for this account as described in the following list.
 - Allow User To Change Password = No
 - Force Periodic Password Changes = No
4. Assign the Upgrade user account to the preferred server to which users have access.
5. Create a login script and assign it to the Upgrade user. The login script must be placed in the appropriate directory on the server where users will log on. For examples of login scripts that use the Upgrade user account, see [Preparing Login Scripts for Push Installations](#).

Running Login Scripts for Push Installations

Push installations from login scripts are the same whether you are running a network client with MS-DOS, Windows 3.1, or Windows for Workgroups. If you are using an Upgrade account, as described earlier, these are the requirements:

- For computers running Windows for Workgroups, the Upgrade account has been created on the Windows NT domain or NetWare server, with a corresponding Upgrade login script, as described in the previous section.
- The Upgrade login script contains these principal entries:
 - The **net use** statements to connect to the appropriate shared directory for the Windows 95 source files (or similar statement for starting the network and connecting to the server on a NetWare network).
 - Statements to start Windows 95 Setup. These statements might involve renaming the user's Startup group and copying the alternate Startup group from the server, as described in [Preparing a STARTUP.GRP File](#).
 - An **exit** statement that closes the login script so that Setup can continue.



To run a login script for a push installation

- Tell users to log on to the network using the Upgrade user account and the **upgrade** password.

When a user logs on, the Windows 95 installation process begins automatically, using the settings in the MSBATCH.INF file specified in the login script.

After copying files, Windows 95 restarts the computer and begins the Run-Once operations (group conversions, and so on). When the Run-Once operations are finished, Windows 95 is completely installed. Notice that this stage requires the user to log on to the network, so all configuration values must be specified in the setup script to support correct logon and to allow Windows 95 Setup to connect to shared resources containing Windows 95 source files.

When the user quits Windows 95 at this point, Setup writes all changes to the Registry. The user can restart the computer and log on using the usual logon name and password.

Introduction

This chapter provides technical information about Windows 95 Setup, including background information about Safe Recovery and detailed descriptions of the Setup and system startup processes. You will find this technical information helpful if you are responsible for troubleshooting Windows 95.

- Phases of the Setup Process
 - Startup and Information Gathering Phase for Windows 95 Setup
 - Hardware Detection Phase
 - File Copy Phase

 - Final System Configuration Phase
- Safe Detection, Safe Recovery, and Verification
 - Safe Detection in Windows 95 Setup
 - Safe Recovery with Setup Log Files
- Windows 95 Startup Process
 - Bootstrapping in the BIOS Phase
 - Loading Hardware Profiles and Real-Mode Drivers
 - Initializing Static VxDs at Startup

 - Loading the Protected-Mode Operating System at Startup
- System Startup Files
 - IO.SYS: The Real-Mode Operating System
 - MSDOS.SYS: Special Startup Values
 - CONFIG.SYS and AUTOEXEC.BAT
 - SYSTEM.INI and WIN.INI
 - BOOTLOG.TXT: The Startup Process Log
- Windows 95 Setup with Other Operating Systems
 - Installing Windows 95 over Windows 3.x
 - Installing Windows 95 for Dual Booting with Windows 3.x
 - Installing Windows 95 over MS-DOS
 - Installing Windows 95 for Dual Booting with Windows NT
 - Installing Windows 95 over DR DOS
 - Installing Windows 95 over OS/2
- Removing Windows 95 from a Computer
 - Removing Windows 95 with Command-Line Startup
 - Removing Windows 95 with Your Previous Operating System
- Troubleshooting Setup and System Startup
 - Troubleshooting Specific Setup Errors
 - Troubleshooting Specific Startup Errors
 - Converting Windows 3.x Program Groups

Phases of the Setup Process

Windows 95 Setup is divided into the following logical phases:

- Startup and information gathering
- Hardware detection
- File copy
- Final system configuration

The following sections provide technical details about what happens in each of these phases.

Startup and Information Gathering Phase for Windows 95 Setup

When you start Windows 95 Setup, the following steps occur:

1. If you started Windows 95 Setup from MS-DOS, Setup searches the local hard disks for previous versions of Windows. If a version of Windows is found, the program prompts you to quit and run Setup from Windows. You can, however, bypass this warning.
2. Setup runs ScanDisk and performs system checks to confirm that the computer is capable of running Windows 95 (enough CPU, memory, and disk space; the correct version of MS-DOS; and so on). If there are insufficient resources, Setup informs you of the problem. For a description of system requirements, see [Introduction to Windows 95 Setup](#).
3. If you started Windows 95 Setup from MS-DOS, Setup checks for an extended memory specification (XMS) provider and installs one if one is not present. Windows 95 Setup looks for existing disk caching and automatically loads SMARTDrive if no other caching is found. The cache size varies, depending on available XMS memory.
4. Setup checks for the existence of certain TSR applications and device drivers that are known to cause problems. If any of these applications are running, Setup warns you before proceeding.
5. If you started Windows 95 Setup from MS-DOS, your Setup installs the minimal Windows 3.1 components and starts these components by using the **shell=setup.exe** command.
The Windows graphical user interface appears. In a normal installation, this is the first thing you see. Up to this point, the processor is operating in real mode.
6. If you started Windows 95 Setup from MS-DOS, Setup switches the processor to standard mode and makes extended memory available.

Windows 95 Setup begins gathering installation information to determine the components to be installed, including the directory for Windows 95 files, user information, and specifics about the devices and software to be installed. For more information, see [Introduction to Windows 95 Setup](#).

Hardware Detection Phase

During the hardware detection phase, Windows 95 Setup analyzes installed computer components, and detects installed hardware devices and connected peripherals. Windows 95 Setup also identifies the hardware resources that are available (for example, IRQs, I/O addresses, and DMAs), identifies the configuration of installed hardware components (for example, IRQs in use), and builds the hardware tree in the Registry.

Windows 95 Setup uses several mechanisms to detect installed hardware devices:

- For a non-Plug and Play-compliant computer (called a legacy computer), Windows 95 checks for known hardware devices by checking I/O ports and specific memory addresses to attempt to identify whether they are being used by known devices. Windows 95 also checks for Plug and Play peripherals connected to legacy computers, which return their own device identification codes.
- For a computer with a Plug and Play BIOS, Windows 95 queries the computer for installed components and their configuration. Windows 95 also checks the computer for connected Plug and Play peripheral devices.

During this phase, Windows 95 Setup tries to identify and resolve hardware conflicts.

Setup uses the Windows 95 hardware detection module to detect hardware components. If a Plug and Play device is detected, its configuration information is added to the Registry. Device drivers are installed based on the Registry settings. Plug and Play ensures that the correct files are installed and that the configuration options are set properly each time Windows 95 is started. For information about Plug and Play, see [Introduction to System Configuration](#) and [Windows 95 Architecture](#).

Windows 95 uses the same hardware detection procedures when you run the Add New Hardware option in Control Panel, when you use the PCMCIA wizard to enable protected-mode support, and the first time you start a computer using a new docking state.

For more information about how detection works, see [Safe Detection, Safe Recovery, and Verification](#).

Setup Technical Discussion

Phases of the Setup Process

File Copy Phase

After you identify and confirm the components to install, Windows 95 Setup begins copying files from the Windows 95 installation disks, compact disc, or network server (whichever was specified). If you selected the option to create a startup disk, this disk is created before the files are copied.

After the necessary files are copied to the computer, Windows 95 Setup prompts you to remove any disks in floppy disk drives and restart the computer to proceed with the final phase of Setup. The following topics describe what happens during the file copy phase.

Creating the Startup Disk

A startup disk is a bootable floppy disk contains utilities that you can use to troubleshoot a malfunctioning system. The startup disk loads the operating system and presents an MS-DOS command line. It is strongly recommended that you create a startup disk for every computer you install Windows 95 on. You can create a Windows 95 startup disk during the file copy phase of Windows 95 Setup, or you can create or update a disk after Windows 95 has been installed by using the Add/Remove Programs option in Control Panel. For information about using the startup disk, see [General Troubleshooting](#).

In general, the startup disk does not provide the following:

- Real-mode support for disk-management software such as ATDOSXL.SYS or Stacker® 4.0
- Access to the network
- Access to CD-ROM drives
- Access to compressed drives from other vendors

To create a startup disk, Windows 95 formats the floppy disk in drive A, and then copies files to the disk in drive A. The files that are copied are described in the following table.

9

Filename	Description
attrib.exe	File attribute utility
command.com	Core operating system file
drvspace.bin	Disk compression utility
ebd.sys	Utility for the startup disk
edit.com	Text editor
fdisk.exe	Disk partition utility
format.com	Disk format utility
io.sys	Core operating system file
msdos.sys	Core operating system file
regedit.exe	Real-mode Registry Editor
scandisk.exe	Disk status and repair utility
scandisk.ini	Disk status utility configuration file
sys.com	System transfer utility

For recovery purposes, you might want to copy the following files into a subdirectory on the startup disk: SYSTEM.DAT, CONFIG.SYS, AUTOEXEC.BAT, WIN.INI, and SYSTEM.INI, plus any CD-ROM or other device drivers. (If you do not place these files into a subdirectory, you'll have to rename them to prevent problems with the startup disk.)

Setup Technical Discussion

Phases of the Setup Process

File Copy Phase

Creating Directories and Copying Files

Windows 95 Setup creates a list of files to copy, depending on the components selected during the information gathering phase. Then various Setup DLLs run to install the network and other components. These DLLs determine exactly which files should be copied from the installation source and which additional directories should be created.

Setup Technical Discussion

Phases of the Setup Process

File Copy Phase

Creating Registry Entries

The Setup DLLs for installing various system components also create appropriate entries in the Registry and change INI file settings as required. (The Registry is created during the hardware detection phase.)

The SYSTEM.1ST file in the root directory is a copy of the Registry created when Setup is complete. To restore a damaged Registry, you can change the file attributes on this file and copy it to SYSTEM.DAT.

Setup Technical Discussion

Phases of the Setup Process

Final System Configuration Phase

During the final system configuration phase, Windows 95 Setup upgrades the existing configuration of Windows and replaces the existing version of MS-DOS with the new Windows 95 operating system (if you are upgrading an existing version of Windows). During this process, Setup restarts the computer running Windows 95.

When Windows 95 Setup completes this phase, it displays a message to indicate that the installation was successful and it prompts you to restart the computer. After you click OK but before Windows 95 Setup restarts the computer, Setup modifies the boot sector of the boot drive by adding a new system file (IO.SYS) that takes the place of the MS-DOS files IO.SYS and MSDOS.SYS. The old files are renamed to IO.DOS and MSDOS.DOS.

After the files are updated and the operating system is configured, Windows 95 Setup uses wizards to guide you through a process to configure peripheral devices (such as printers) connected to the computer. More files might also be copied here, and you might be asked to restart the computer again.

Setup Technical Discussion

Phases of the Setup Process

Final System Configuration Phase

Initializing the System after Setup

After first restarting the computer during the final system configuration phase, Windows 95 Setup updates configuration files by performing the following steps:

- WININIT.EXE processes three sections in WININIT.INI to combine all the virtual devices (VxDs) into VMM32.VXD and to rename files initially used by Setup, including ARIAL.WIN, USER32.TMP, and LOGO.SYS.
- SYSTEM.DAT is renamed to SYSTEM.DA0, and SYSTEM.NEW is renamed to SYSTEM.DAT.
- A flag is set in the Registry that indicates this is the first time Windows 95 is being run after a new installation. Hardware manufacturers can also add specific entries to the Run-Once Registry key.
- The Run-Once module is run to complete the initial configuration of PCMCIA and MIDI devices, to set up printers (if you are not installing in an existing Windows directory), and to run custom hardware manufacturers' setup programs.

Important If the system fails when running these first-time programs, restart Windows 95 rather than rerunning Windows 95 Setup.

- The Program Group converter (GRPCONV) adds existing Windows 3.x .GRP files to the PROGRAMS directory and renames the files using long filenames.

Windows 95 installation is now complete.

Setup Technical Discussion

Phases of the Setup Process

Final System Configuration Phase

Modifying the Boot Drive after Setup

Windows 95 places the real-mode operating system files named IO.SYS, MSDOS.SYS, and COMMAND.COM in the root directory of the computer's boot drive. The real-mode files needed to connect to the network are also placed on the computer's boot drive or device. (These filenames vary, depending on the network you use.)

Windows 95 detects boot drives and compression drivers, and writes certain startup files to the boot device.

Setup Technical Discussion

Phases of the Setup Process

Final System Configuration Phase

Verifying the Installation

Setup has an option for verifying the installation, as described in Safe Detection, Safe Recovery, and Verification. So, Windows 95 Setup can install files on your disk without actually having to transfer all of the file data from the floppy disk drive, network, or other source. As a part of this process, Windows 95 rebuilds VMM32.VXD or recopies any files it finds to be damaged.

For Safe Recovery, Windows 95 Setup places the following two lines in AUTOEXEC.BAT during installation:

```
@if exist c:\wininst0.400\suwarn.bat call C:\wininst0.400\suwarn.bat  
@if exist c:\wininst0.400\suwarn.bat del C:\wininst0.400\suwarn.bat
```

The SUWARN.BAT file is run only once after a failed installation. These lines are removed when Windows 95 Setup is complete.

Setup Technical Discussion

Safe Detection, Safe Recovery, and Verification

This section provides technical details about the features that ensure safe hardware detection, recovery from Setup problems, and configuration verification in Windows 95 Setup.

Safe Detection in Windows 95 Setup

Devices and buses are grouped as classes in Windows 95 for purposes of detecting and installing device drivers and managing system resources. Windows 95 differentiates between devices and drivers that comply with the Plug and Play specification and earlier versions of devices and drivers (which are referred to in the *Windows 95 Resource Kit* as legacy devices). Because of this differentiation, Windows 95 Setup detects hardware components and devices in two ways:

- Using an interactive query detection process for legacy devices and peripherals
- Using Plug and Play detection to identify Plug and Play-compliant devices and peripherals

After Setup detects a device, it adds configuration information to the Registry and installs the appropriate device drivers. The same procedures used during Setup for detecting Plug and Play or legacy hardware devices are also used to detect or configure new devices after Windows 95 is installed.

Windows 95 supports detection for base computer components such as communications ports and processor type, and provides more robust detection of computer devices, such as display adapters, pointing devices, hard-disk controllers, floppy-disk controllers, and network adapters.

Windows 95 Setup also tries to detect any hardware resource conflicts early in the installation process. This helps to avoid the problems that occur when hardware resources such as IRQs, I/O addresses, or DMAs are used by more than one device.

To avoid computer failure during the detection process, Windows 95 uses a safe detection method to search for hints from configuration files, read-only memory (ROM) strings, or drivers loaded in memory to determine whether the computer contains each class of hardware. If no such hints are found, the detection process skips detecting the entire class. If hints are found, then the detection process seeks information from specific I/O ports.

Windows 95 automatically reads the command lines in CONFIG.SYS to find hints for device class detection. Then Windows 95 loads detection modules based on information in the MSDET.INF file, which lists the hardware to be detected and points to specific INF files for each device class (for example, SCSI.INF for SCSI host adapters). Device information from the INF files is written to the Registry. For more information about the format of these files, see [Windows 95 INF Files](#).

Windows 95 can also read a particular CONFIG.SYS **device=** line for resource information to be avoided (that is, protected) during the detection process. This is useful if Windows 95 Setup cannot detect or support a certain device when it's known that the detection process can cause such a device to fail. For example, the detection process could render a fax modem inoperative because scanning the I/O port might confuse the device driver. Windows 95 can read the **device=** line in CONFIG.SYS for this model and protect the associated I/O region from other detection modules.

Windows 95 Setup asks you to confirm which classes should be skipped in the detection process. If you know that the computer has a device in one of those classes, Setup can be forced to detect that device class.

Safe detection exists for four classes of devices:

- Network adapters
- SCSI controllers
- Proprietary adapters for CD-ROM
- Sound cards

Setup Technical Discussion

Safe Detection, Safe Recovery, and Verification

Safe Detection in Windows 95 Setup

Safe Detection for Network Adapters

Windows 95 Setup performs the following kinds of steps for safe detection of network adapters:

- Find LSL.COM in memory and, if present, inquire for network adapter settings.
- Find IPX.COM in memory and, if present, inquire for network adapter settings.
- Search the Windows, Windows for Workgroups, and LAN Manager directories for PROTOCOL.INI; if present, read the file to find network adapter settings.

Setup Technical Discussion

Safe Detection, Safe Recovery, and Verification

Safe Detection in Windows 95 Setup

Safe Detection for SCSI Controllers

When trying to detect SCSI adapters, Windows 95 Setup checks for device drivers in CONFIG.SYS, and then scans ROM strings from the SCSI adapter for manufacturer names. If known drivers or known strings are found, then the corresponding detection procedure for that class is used; otherwise, the entire class is skipped. A list of the known strings and drivers that Windows 95 Setup checks is stored internally in a detection DLL. (For more information about the SCSI devices and drivers that Windows 95 supports, see the Manufacturers and Models lists in the Add New Hardware option in Control Panel.)

Different SCSI devices require different methods for safe detection. For example, a SCSI card typically is used with a combination of hard disks, CD-ROM drives, tape backup drives, scanners, and similar devices. For everything to work (except the hard disk), some sort of device driver must be loaded in CONFIG.SYS.

For hard disk drives, however, the driver usually is not loaded in CONFIG.SYS, but INT 13 ROM are enabled. Therefore, safe detection for SCSI class devices looks for a ROM string with a manufacturer's name.

Setup Technical Discussion

Safe Detection, Safe Recovery, and Verification

Safe Detection in Windows 95 Setup

Safe Detection for Proprietary Adapters for CD-ROM

Windows 95 supports Mitsumi, SONY, and Panasonic proprietary adapters for CD-ROM. Because drivers for these devices are loaded in CONFIG.SYS, safe detection first scans CONFIG.SYS for the drivers that are present. If a **device=** line for such a driver is found, the corresponding detection module is loaded for that type of device.

Setup Technical Discussion

Safe Detection, Safe Recovery, and Verification

Safe Detection in Windows 95 Setup

Safe Detection for Sound Cards

Safe detection scans CONFIG.SYS and reads SYSTEM.INI for hints about sound cards. If known drivers are not found, the entire class is skipped.

If Windows 95 doesn't have detection code for certain hardware, the equipment manufacturer can force a device to be detected by adding information about it in the MSDET.INF file. Windows 95 detection behaves as if it has detected the device and installs the device according to the INF information provided by the equipment manufacturer.

Windows 95 Setup does not detect sound cards by scanning I/O ports; instead, it checks only CONFIG.SYS and SYSTEM.INI and performs detection prescribed in MSDET.INF. Detection of sound cards by scanning I/O ports can cause the computer to stall. This is because detection calls a driver specific to a device class to send a signal to an I/O port. The driver expects a predetermined response, such as a signature from the adapter's ROM. If the wrong driver sends a signal to an I/O port address occupied by a different device class, the computer can stall.

Safe Recovery with Setup Log Files

Windows 95 Setup creates several log files: BOOTLOG.TXT, DETLOG.TXT, NETLOG.TXT, and SETUPLOG.TXT, plus DETCRASH.LOG if Setup fails. The following sections describe these files.

Basically, there are three points at which the computer might stop or stall during Windows 95 Setup: before, during, or after hardware detection.

- If Setup fails before hardware detection, Windows 95 Setup recovers by reading SETUPLOG.TXT to determine where the system stalled, what to redo, and what to skip.
- If Setup fails during hardware detection, the DETCRASH.LOG file is created, containing information about the detection module that was running and the I/O port or memory resources it was accessing when the failure occurred.

When the detection process finds this file, it automatically runs in Safe Recovery mode to verify all the devices already in the Registry and then skips all detection modules up to the failed module. Safe Recovery then skips detection and any attempts to configure the failed module, in effect skipping the action that caused the failure. Then, Safe Recovery continues the detection process, starting with the next module. If the detection process is completed successfully, DETCRASH.LOG is deleted.

DETCRASH.LOG can be read only by Setup. For information about the text equivalent of this information, see [DETLOG.TXT: The Hardware Detection Log File](#).

- Sometimes the detection process causes some devices to quit working (such as a CD-ROM drive or a network connection). If you rerun Setup, Safe Recovery recognizes that the detection process has already been completed successfully and assumes that all the necessary hardware information is in the Registry. Therefore, it skips the detection process completely at this point and continues the installation process.

SETUPLOG.TXT: The Setup Log File

The SETUPLOG.TXT file is an ASCII text file that contains Windows 95 Setup information created during the installation process. While Windows 95 is being installed, corresponding entries are written to SETUPLOG.TXT, listing information about the specific steps, their sequence, and the error conditions encountered. This file is used by Setup for recovery in case of setup failure, and it can also be used for troubleshooting errors that occur during the installation process.

Setup uses the information in SETUPLOG.TXT to ensure that the installation does not fail twice because of the same problem. If you restart Windows 95 Setup after a setup process fails, Setup reviews the contents of SETUPLOG.TXT to determine which steps completed successfully. If SETUPLOG.TXT indicates that a process started but does not indicate that the process completed, then that part of the installation process is skipped and the next part is processed. Even if Setup encounters devices that cause several installation attempts, the installation process will always progress and skip the modules that failed.

SETUPLOG.TXT is stored on the computer's root directory. Information is added to the file according to the order of the steps of the installation process. If an error occurs during installation, you can determine the probable cause of the error by examining the entries at the end of SETUPLOG.TXT.

Information in SETUPLOG.TXT is divided into the following basic categories:

- Selected Setup sections, including [OptionalComponents], [System], [NameAndOrg], and [batch_settings]
- Setting up of system startup parameters
- Selecting the directory
- Beginning of installation process
- Queuing of needed files
- Copying of needed files
- Preparing for restarting the system

Tip The [OptionalComponents], [System], and [NameAndOrg] sections can be copied from SETUPLOG.TXT on a computer with a complete installation of Windows 95 and then added to equivalent sections in MSBATCH.INF, as described in [Custom, Automated, and Push Installations](#). Notice, however, that these sections in SETUPLOG.TXT do not include networking information.

The following table shows entries in SETUPLOG.TXT file to check for information about the Setup process. Because entries are added to SETUPLOG.TXT in the order that the related actions occur during Setup, you might be able to find a probable cause of any error by examining the entries at the end of the file.

SETUPLOG.TXT entry	Description
InstallType	Type of installation
InstallDir	Directory where Windows 95 is installed
detection	Detection status
RunningApp	Applications running during installation
RootFilesRenamed	Files renamed in the root directory
error	Errors logged during installation
failed	Failures that occurred during installation
[OptionalComponents]	Optional components installed
[System]	System hardware configuration
batch settings	Installation parameters (that is, MSBATCH.INF settings)

Registry	Registry initialization status
<i>filename</i>	Verification that a specific file was loaded during Setup
[Choose Directory]	Location and type of Windows files
[FileCopy]	Files copied during Setup
[Restart]	Issues to be completed after the computer is restarted

Tip for Verifying System Files

With Windows 3.x, it was not easy to recover files, such as a component file that was accidentally deleted or a system file that was corrupted. You either had to use the Expand utility to copy the file, or you had to reinstall Windows 3.x to restore the lost file. SETUPLOG.TXT is part of the Windows 95 solution to verifying the integrity of installed components.

If you run Windows 95 Setup after Windows 95 is already installed, Setup prompts you either to reinstall Windows 95 or simply to verify installed components. If you want to verify installed components, Setup examines SETUPLOG.TXT and reruns the installation process without completely copying all operating system components. Windows 95 verifies the integrity of files installed during Setup with the files on the Windows 95 installation disks. If the integrity check fails due to a missing or corrupted file on the computer, Setup automatically reinstalls that file.

Setup Technical Discussion

Safe Detection, Safe Recovery, and Verification

Safe Recovery with Setup Log Files

DETLOG.TXT: The Hardware Detection Log File

The DETLOG.TXT file contains a record of whether a specific hardware device was detected and identifies the parameters for the detected device.

During Windows 95 Setup, after the information gathering phase, Setup begins hardware detection, which can also occur when you use the Add New Hardware option in Control Panel to add a new device. Both Windows 95 Setup and Device Manager use SYSDETMG.DLL, which contains all the detection modules for each device class and specific devices.

Windows 95 loads detection modules based on information in MSDET.INF that points to specific INF files for each device class, from which information is retrieved and written to the Registry. The device class installers are DLLs that work with Device Manager to install, configure, and remove devices or classes of devices in the system. Device Manager generates a list of compatible drivers for the device from the appropriate INF file. For information about using Device Manager to configure device drivers, and for information about the device classes used to identify logical device types, such as display, keyboard, and network adapters, see [Devices](#).

By creating an updated DETLOG.TXT file every time the detection process runs, the detection module tracks the detected devices and the I/O port addresses used. Any existing DETLOG.TXT is renamed DETLOG.OLD. If the detection process causes Setup to stall or the computer to lock up, then a binary file named DETCRASH.LOG is created. DETLOG.TXT is an ASCII text file created only for users to read; Windows 95 Setup reads the binary information in DETCRASH.LOG. Any changes made to DETLOG.TXT are not passed to DETCRASH.LOG.

The DETLOG.TXT file can be found in the root directory of the startup drive after Windows 95 is installed. The entries in DETLOG.TXT are placed in the order of the hardware information discovered as each step of the detection process is carried out. The following table briefly describes entries that appear in DETLOG.TXT.

Summary of DETLOG.TXT Entries

Entry	Description
-------	-------------

Beginning of DETLOG.TXT:

Parameters= "xxxxxx"	Shows the switches specified in the Setup command line (that is, setup /p xxxxxx). For example: Parameters "", Flags=01002233
WinVer = #####	Shows that environment detection is run. The MS-DOS version is in the high word and the Windows version is in the low word. For example: WinVer=0614030b,
AvoidMem= #####h-#####h	If present, indicates the address range specified as upper memory blocks (UMB), which detection avoids. For example: AvoidMem=cd4a0-cd50f
DetectClass: Skip Class Media	Indicates that detection found no hints that the computer might have a particular device, so it skipped that class. For example, DetectClass: Skip Class Media indicates that no sound entries appear in the configuration files, so detection skips all the sound card detection modules. For DetectClass: Skip Class Adapter , detection skips searching for proprietary CD-ROM adapters such as SONY, Mitsumi, and Panasonic. DetectClass: Skip Class Net indicates that detection was skipped for network adapters.
DetectClass Override:	If one or more skip class entries appear in DETLOG.TXT, the Analyzing Your Computer screen appears in Setup to confirm skipping those classes, so you can override the decision. Related DetectClass Override lines appear in DETLOG.TXT for the classes checked.
Custom Mode:	Describes your selection for the devices you tell Windows 95 not to detect. For example: CustomMode: resetting class ADAPTER ; Don't detect EtherLinkIII CustomMode: DETECTELNK3=0
Devices verified =	Indicates the number of devices verified from the Registry. If the number is 0, it usually means there was no existing Registry or the Registry was empty.

Detecting system devices:

Checking for:	Specifies that detection began looking for that device. The entry is followed by description of the device or class being sought. When detection is checking for a device such as the Programmable Interrupt Controller, the Checking for: entry is followed by a QueryIOMem: entry specifying the Caller, rcQuery, and I/O range checked. If a device is detected, then a Detected: entry is added, specifying the device resource information. For example: Checking for: Programmable Interrupt Controller QueryIOMem: Caller=DETECTPIC,
---------------	---

```

rcQuery=0
IO=20-21,a0-a1
Detected: *PNP0000\0000 =
    [1] Programmable Interrupt
Controller
IO=20-21,a0-a1
IRQ=2

```

Detecting network adapters:

Checking for: This section lists the attempts to detect network adapters. For example:

```

Checking for: Network Cards using
Novell
    ODI Driver
Checking for: EISA Network Cards

```

PROTOCOL.INI Section If detection finds PROTOCOL.INI, it saves the **[net_card]** section in DETLOG.TXT. For example:

```

Checking for: Network Cards using
Microsoft Windows For Workgroups
; path to WFW protocol.INI
WFW: path=d:\w311\protocol.ini
; protocol.ini mac driver section
Protocol.ini: [MS$EE16]
Protocol.ini: DriverName=EXP16$

```

NCD: detecting network adapter Indicates that detection has found a network adapter using safe detection (usually PROTOCOL.INI), but the system has information for verifying this adapter. If this adapter is verified, a **Detected** line follows. For example:

```

NCD: detecting network adapter
*pnp812d
QueryIOMem: Caller=DETECTWFW,
rcQuery=0
IO=300-30f

```

The hardware detection process continues examining computer hardware. The “|” symbol in the **IO=** line (for example, **IO=200-201 | 3e0-3e1**) indicates a range of I/O entries that are checked during the detection process. In the DETLOG.TXT file, you will find a **QueryIOMem:** and an **IO=** line for each I/O address checked.

For most devices, multiple I/O addresses are checked, which can result in a detailed and redundant device detection list. The I/O address ranges checked during detection are grouped on one I/O line. Multiple addresses on an **IO=** line are separated by commas. For example:

```

Checking for: ATI Ultra Pro/Plus (Mach 32) Display Adapter
QueryIOMem: Caller=DETECTMACH32, rcQuery=0
IO=3b0-3bb,3c0-3df
QueryIOMem: Caller=DETECTMACH32, rcQuery=0
Mem=a0000-ffff

```

If the system stalls during hardware detection, you can determine the probable cause of the error by examining the last entries in DETLOG.TXT. You can use the information in this file to determine specific error conditions occurring in the hardware detection, and reconfigure or replace the specific adapter or device. The following table shows specific kinds of entries to check in DETLOG.TXT for information about the results of the hardware detection process.

DETLOG.TXT Entries to Check for Troubleshooting

Entry	Description
detected	Detected devices

AvoidMem	Address ranges of UMBs avoided during detection
error	Errors logged during system detection
WinFlags	Setup mode used
PROTOCOL.INI	PROTOCOL.INI information that was saved during system upgrade
CustomMode	Hardware that was removed from detection in the custom Analyzing Your Computer dialog box
Devices verified	Devices found in Registry; if the value is 0, then there was no existing Registry or the Registry was empty

Some additional notes on DETLOG.TXT and hardware detection:

- Detection does not detect enumerated devices such as ISA Plug and Play devices, PCI devices, and PCMCIA devices. For information about these devices, see [Introduction to System Configuration](#).
- If the computer stalls during detection, and you rerun Windows 95 Setup and choose Safe Recovery, new detection information is appended to the previous DETLOG.TXT file. The previous version of DETLOG.TXT is saved as DETLOG.OLD, overwriting any previous DETLOG.OLD files.

The hardware that has been tested and shown to be compatible with Windows 95 appears in the Manufacturers and Models lists in the Add New Hardware option in Control Panel.

Setup Technical Discussion

Safe Detection, Safe Recovery, and Verification

Safe Recovery with Setup Log Files

NETLOG.TXT: The Network Setup Log File

This file describes the detection results for network components during Windows 95 Setup. For information about NETDET.INI, the file that Setup uses to determine how to install networking components on computers running NetWare clients, see [Windows 95 on NetWare Networks](#).

The following table describes typical entries in a NETLOG.TXT file after you run Windows 95 Setup for the first time. In this example, Client for Microsoft Networks is installed with the IPX/SPX-compatible protocol, and both are bound to an Intel® EtherExpress™ network adapter.

NETLOG.TXT entry	Description
ClassInstall (0x6) on Intel EtherExpress 16 or 16TP at Enum\Root\ *PNP812D\0000	Network installation begins.
Examining class NET	Network detection is searching for network software of four class types: NET (network adapters), NETTRANS (protocols), NETCLIENT (clients), and NETSERVICES (services such as File and Printer Sharing).
Upgrade 2.00025000= VREDIR	A network client was found on the computer.
Upgrade to: VREDIR	The version of the network client was upgraded to the version included in Windows 95.
NdiCreate (Client for Microsoft Networks) OK	Setup successfully created an internal object representing the network client.
NdiCreate (Intel EtherExpress 16 or 16TP)	Setup successfully created an internal object representing the network adapter.
CreateNetwork, Batch=0	Setup referenced a batch file.
NdiCreate (IPX/SPX- compatible Protocol)	Setup successfully created an internal object representing the IPX/SPX-compatible protocol.
ClassInstall (0x6) end	
ClassInstall (0x9) on Intel EtherExpress 16 or 16TP at Enum\Root*PNP812D\0000	Protocols are about to be bound to the network adapter.
Validating IPX/SPX- compatible Protocol at Enum\Network\NWLINK\0000, rc=0x0	The IPX/SPX-compatible protocol is added to the Registry and bound to the network adapter.
ClassInstall (0x9) on Intel EtherExpress 16 or 16TP at Enum\Root*PNP812D\0000	Clients are about to be bound to the network adapter.
Validating Client for Microsoft Networks at Enum\Network\VREDIR \0000, rc=0x0	Client for Microsoft Networks is added to the Registry and bound to the network adapter.

ClassInstall (0x9) end

Setup has finished binding the protocol to the network adapter.

ClassInstall (0xa) on Intel EtherExpress 16 or 16TP at Enum\Root*PNP812D\0000

The network setup process is concluded.

ClassInstall (0xa) end

ClassInstall (0xc) on Intel EtherExpress 16 or 16TP at Enum\Root*PNP812D\0000

ClassInstall (0xc) end

Setup Technical Discussion

Windows 95 Startup Process

Windows 95 includes new system files, Plug and Play mechanisms, and various options for starting the operating system. This section describes the Windows 95 system startup sequence.

During the real-mode startup process, devices use only static configurations; that is, no dynamic resource allocation or arbitration is provided. When the system startup process switches to protected mode, Configuration Manager ensures all devices are configured properly, as described in [Windows 95 Architecture](#).

The system startup includes four phases:

- Bootstrapping the system with BIOS in control
- Loading MS-DOS drivers and TSRs for compatibility
- Initializing static VxDs in real mode
- Putting the protected-mode operating system in control and loading the remaining VxDs

Setup Technical Discussion

Windows 95 Startup Process

Bootstrapping in the BIOS Phase

Microsoft worked with several hardware manufacturers to define a new Plug and Play BIOS specification, which defines the interactions among a Plug and Play BIOS, Plug and Play devices, and option ROMs (sometimes called adapter ROMs). The Plug and Play BIOS enables and configures Plug and Play boot devices. The Plug and Play BIOS also passes configuration information to Configuration Manager in Windows 95 for configuring the remaining adapters and devices.

Setup Technical Discussion

Windows 95 Startup Process

Bootstrapping in the BIOS Phase

Booting with a Legacy BIOS

For legacy computers that do not have Plug and Play BIOS, the BIOS enables all devices on the ISA bus. A Plug and Play ISA card that has an option ROM must start up when the computer is turned on with the option ROM enabled.

Setup Technical Discussion

Windows 95 Startup Process

Bootstrapping in the BIOS Phase

Booting with a Plug and Play BIOS

A Plug and Play BIOS accesses nonvolatile RAM to determine which Plug and Play ISA cards should be enabled, where their option ROMs should be mapped, and what I/O, DMA, and other assignments are to be given to the cards.

The BIOS then programs the Plug and Play cards before the power-on self-test (POST). All cards that do not have configurations stored in the BIOS are disabled completely, reducing the chance of a conflict.

The Plug and Play BIOS also configures all devices on the motherboard. Some devices might have been disabled or assigned to different I/O addresses, IRQ settings, and so on, by Configuration Manager.

Loading Hardware Profiles and Real-Mode Drivers

After BIOS initialization, the operating system attempts to determine the current configuration, including whether the computer is a docking station. This is done by using a hardware profile that Windows 95 selects before CONFIG.SYS is processed. The hardware profile is built by a detection process that collects information about interrupt usage, BIOS serial and parallel ports, BIOS computer identification, Plug and Play BIOS docking-station data, and, if possible, docking-station data that is unique to each OEM. Then the detection process builds a 2-byte value known as the current hardware profile (or the current configuration).

Each hardware profile has a name that matches a top-level menu item in a multiconfigured CONFIG.SYS file (that is, the long text in the menu, not the section name enclosed in square brackets). Windows 95 automatically selects that multiconfiguration menu item and processes the corresponding section of CONFIG.SYS.

CONFIG.SYS and AUTOEXEC.BAT are processed at this point. Although these files are not required for Windows 95, they are used for backward compatibility with applications created for MS-DOS or Windows 3.x. In Windows 95, CONFIG.SYS and AUTOEXEC.BAT are processed much like they are processed under MS-DOS 6.x. Drivers and TSRs specified in these files are loaded in real mode.

For more information, see [System Startup Files](#).

Note The real-mode MS-DOS errors are standard, as documented in the *MS-DOS 6.0 Programmer's Reference*.

Initializing Static VxDs at Startup

Windows 95 supports static VxDs that load during system startup in the same way as Windows 3.x VxDs, and it also supports dynamically loaded VxDs. VMM32.VXD includes the real-mode loader, the executable Virtual Machine Manager, and common static VxDs. Notice, however, that if a VxD file is in the Windows SYSTEM\VMM32 directory, Windows 95 loads it in addition to the combined VxDs in MRC12.VXD.

Note If you want to update a VxD that has been bound into the monolithic VMM32.VXD, place the VxD file in the SYSTEM\VMM32 directory. Windows 95 always checks that directory and uses any individual VxDs it finds instead of loading those bound in VMM32.VXD.

The following list shows the VxDs typically combined to create VMM32.VXD. (A custom list is built for each computer.) These drivers used to be specified in the [386enh] section of SYSTEM.INI.

Typical VxDs Combined to Create VMM32.VXD

*biosxlat	*ios	*vdd	*vmouse
*configmg	*parity	*vdef	*vmpoll
*dynapage	*reboot	*vfat	*vsd
*ebios	*vcache	*vfbackup	*vtdapi
*ifsmgr	*vcomm	*vkd	*vwin32
*int13	*vcond	*vmcpd	*vxldr

VMM32 loads VxDs in three steps:

- VMM32 loads base drivers specified in the Registry, which contains entries for every VxD not directly associated with any hardware. VxDs are located in this branch of the Registry:
`Hkey_Local_Machine\System\CurrentControlSet\Services\VxD`
- If VMM32 finds a value **StaticVxD=** in any Registry key, it loads that VxD and runs its real-mode initialization. For example, the following entry loads *V86MMGR:

```
SYSTEM\CurrentControlSet\Services\VxD\V86MemoryManger
  Description=MS-DOS Virtual 8086 Memory Manager
  Manufacturer=Microsoft
  StaticVxD=*V86MMGR
  EMMEXCLUDE=E000-EFFF
```
- VMM32 loads the static VxDs specified in the **device=*VxD** lines in the [386enh] section of SYSTEM.INI. These VxDs are actually loaded from VMM32, and appear in SYSTEM.INI only for backward compatibility.

If a specific device conflicts with a device loaded from the Registry, the device specified in SYSTEM.INI takes precedence. However, if the device specified in SYSTEM.INI cannot be found, an error will occur.

Many Windows 95 driver models, such as IOS (for disk drivers) and the network, support dynamically loaded device drivers. These VxDs are not loaded by the VMM32 real-mode loader, but are loaded by a device loader that is responsible for loading and initializing the drivers at the correct time and in the correct order.

For example, for SCSI adapter miniport drivers, the device loader is *IOS. The entries for a SCSI adapter are found in this Registry key:

```
Hkey_Local_Machine\System\CurrentControlSet\Services\Class
```

Because there is no **StaticVxD=xxx** line in this Registry entry, the VMM32 real-mode loader does nothing when Windows 95 identifies this device.

Configuration Manager attempts to find any device node that has a **DevLoader=** entry in the Registry. The device loader (in the previous example, *IOS) examines the Registry, finds the **PortDriver=** entry, loads the driver and any associated support drivers, and initializes the adapter.

Setup Technical Discussion

Windows 95 Startup Process

Loading the Protected-Mode Operating System at Startup

In the previous phase, these elements of the operating system were loaded:

- WIN.COM, which controls the initial checks and loading of the core Windows 95 components
- VMM32.VXD, which creates virtual machines and initiates VxD loading
- SYSTEM.INI, which is read for entries that differ from Registry entries

After all static VxDs are loaded, VMM32.VXD switches the processor to operate in protected mode, and the last phase of the boot process begins. This phase involves loading the protected-mode components of the operating system.

Setup Technical Discussion

Windows 95 Startup Process

Loading the Protected-Mode Operating System at Startup

Loading Protected-Mode VxDs at Startup

The protected-mode Configuration Manager is initialized for importing configuration information from a Plug and Play BIOS (if available); otherwise, it develops the Plug and Play hardware tree by enumerating devices and loading dynamically loadable device drivers. These device drivers are identified by loading drivers from a specific directory.

The next phase resolves device resource conflicts for every device in the tree and then informs the devices of their configuration. When all devices have been enumerated, all conflicts have been resolved, and all devices have been initialized, Windows 95 is ready to be used.

Setup Technical Discussion

Windows 95 Startup Process

Loading the Protected-Mode Operating System at Startup

Loading the Final System Components at Startup

The remaining Windows 95 system components are loaded in the following sequence:

- KERNEL32.DLL provides the main Windows components, and KRNL386.EXE loads the Windows device drivers
- GDI.EXE and GDI32.EXE provide the graphic device interface code
- USER.EXE and USER32.EXE provide the user interface code
- Associated resources, such as fonts, are loaded
- WIN.INI values are checked
- The shell and desktop components are loaded

At this point, a prompt appears so that you can log on by typing a user name and a password. After you log on, Windows 95 can process user-specific configuration information. If you do not log on, default settings are used. If Windows 95 is configured for network logon, the unified Windows 95 logon can be used to log on to the network during this process.

After Windows 95 is loaded and you log on, the STARTUP directory is processed.

System Startup Files

This section describes the following files involved in Windows 95 system startup:

- IO.SYS, which is the real-mode operating system that replaces the MS-DOS version; VMM32 and Windows 95 device drivers take control from IO.SYS
- MSDOS.SYS, which contains special information for Windows 95 and is also created for compatibility with applications that require this file to be present before they can be installed
- CONFIG.SYS and AUTOEXEC.BAT
- SYSTEM.INI and WIN.INI
- BOOTLOG.TXT, the log file that describes the system startup processes

The following table summarizes how Setup renames the system files for the previous operating system when Windows 95 is installed. (The Windows 95 files are renamed with .W40 filename extensions when you start the computer with the other operating system.)

Original MS-DOS filename	Renamed file under Windows 95
autoexec.bat	autoexec.dos
command.com	command.dos
config.sys	config.dos
io.sys (or ibmbio.com)	io.dos
mode.com	mode_dos.com
msdos.sys (or ibmdos.com)	msdos.dos

IO.SYS: The Real-Mode Operating System

Windows 95 uses a new system file, IO.SYS, which replaces the MS-DOS system files (IO.SYS and MSDOS.SYS). This real-mode operating system file contains the information needed to start the computer. Your computer no longer needs CONFIG.SYS and AUTOEXEC.BAT to start the Windows 95 operating system (although these files are preserved for backward compatibility with certain applications and drivers).

Note The Windows 95 IO.SYS file is automatically renamed to WINBOOT.SYS if you start the computer using your previous operating system.

The drivers loaded by default in IO.SYS include the following, if these files are found on the hard disk:

- HIMEM.SYS
- IFSHLP.SYS
- SETVER.EXE
- DBLSPACE.BIN or DRVSPACE.BIN

Most of the common functionality provided by the various CONFIG.SYS file entries are now provided by default in IO.SYS. The following table lists the common entries in CONFIG.SYS that are now incorporated into IO.SYS for Windows 95.

CONFIG.SYS Settings Incorporated in Windows 95 IO.SYS

Setting	Description
dos=high	Specifies that MS-DOS should be loaded in the high memory area (HMA). Also, the umb value is included if EMM386 is loaded from CONFIG.SYS. (IO.SYS does not load EMM386.)
himem.sys	Enables access to the HMA. This line loads and runs the real-mode Memory Manager. HIMEM.SYS is loaded by

	default in Windows 95.
<code>ifshlp.sys</code>	Installable File System Helper, which loads device drivers. This allows the system to make file system calls. Until this is loaded, only the minimal file system from IO.SYS is used. After this point, the full file system is available.
<code>setver.exe</code>	Optional TSR-type device. It is included for compatibility reasons. Some MS-DOS–based applications require a specific version of MS-DOS to be running. This file responds to applications that query for the version number and sets the version number required.
<code>files=</code>	Specifies the number of file handle buffers to create. This is specifically for files opened using MS-DOS calls and is not required by Windows 95. It is included for compatibility with older applications. The default value is 60.
<code>lastdrive=</code>	Specifies the last drive letter available for assignment. This is not required for Windows 95 but is included for compatibility with older applications. If Windows 95 Setup finds this entry, it is moved to the Registry. The default value is z.
<code>buffers=</code>	Specifies the number of file buffers to create. This is specifically for applications using IO.SYS calls and is not required by Windows 95. The default value is 30.
<code>stacks=</code>	Specifies the number and size of stack frames. This is not required for Windows 95 but is included for compatibility with older applications. The default value is 9,256.
<code>shell=</code> <code>command.com</code>	Indicates what command process to use. By default, the /p switch is included to indicate that the command process is permanent and should not be unloaded. If the /p switch is not specified, AUTOEXEC.BAT is not processed and the command process can be unloaded when quitting the operating system.
<code>fcbs=</code>	Specifies the number of file control blocks that can be open at the same time. You should use a fcbs= line in CONFIG.SYS only if you have an older program that requires such a setting. The default value is 4.



To override default values in Windows 95 IO.SYS

- Place an entry in CONFIG.SYS with the value you want.

The values in IO.SYS cannot be edited. If CONFIG.SYS contains switches or other parameters for any of the drivers or settings created by IO.SYS, the CONFIG.SYS entries override the IO.SYS defaults. Entries for **files=**, **buffers=**, and **stacks=** must be set in CONFIG.SYS to at least the default values in IO.SYS.

Note IO.SYS does not load EMM386.EXE. If any of your applications requires expanded memory or loads data into the high memory area, EMM386 must be loaded in CONFIG.SYS. For details about using EMM386, see [Command-Line Commands Summary](#).

MSDOS.SYS: Special Startup Values

Windows 95 Setup creates a hidden, read-only system file named MSDOS.SYS in the root of the computer's boot drive. This file contains important paths used to locate other Windows files, including the Registry. MSDOS.SYS also supports an [Options] section, which you can add to tailor the startup process.

The following example shows a typical file with default values:

```
[Options]
BootGUI=1

[Paths]
WinDir=C:\WINDOWS
WinBootDir=C:\WINDOWS
HostWinBootDrv=C
```

Most values in the [Options] section are Boolean — that is, the value can be 1 (enabled) or 0 (disabled). The following table describes entries in MSDOS.SYS, using the typical default values.

MSDOS.SYS Values**Entry** **Description****[Paths] section:**

HostWinBootDrv=c	Defines the location of the boot drive root directory.
WinBootDir=	Defines the location of the necessary startup files. The default is the directory specified during Setup; for example, C:\WINDOWS.
WinDir=	Defines the location of the Windows 95 directory as specified during Setup.

[Options] section:

BootDelay= <i>n</i>	Sets the initial startup delay to <i>n</i> seconds. The default is 2. BootKeys=0 disables the delay. The only purpose of the delay is to give the user sufficient time to press F8 after the Starting Windows message appears.
BootFailSafe=	Enables Safe Mode for system startup. The default is 0. (This setting is enabled typically by equipment manufacturers for installation.)
BootGUI=	Enables automatic graphical startup into Windows 95. The default is 1.
BootKeys=	Enables the startup option keys (that is, F5, F6, and F8). The default is 1. Setting this value to 0 overrides the value of BootDelay=<i>n</i> and prevents any startup keys from functioning. This setting allows system administrators to configure more secure systems. (These startup keys are described in General Troubleshooting .)
BootMenu=	Enables automatic display of the Windows 95 Startup menu, so that the user must press F8 to see the menu. The default is 0. Setting this value to 1 eliminates the need to press F8 to see the menu.
BootMenuDefault=	Sets the default menu item on the Windows Startup

#	menu; the default is 3 for a computer with no networking components, and 4 for a networked computer.
BootMenuDelay=#	Sets the number of seconds to display the Windows Startup menu before running the default menu item. The default is 30.
BootMulti=	Enables dual-boot capabilities. The default is 0. Setting this value to 1 enables the ability to start MS-DOS by pressing F4 or by pressing F8 to use the Windows Startup menu.
BootWarn=	Enables the Safe Mode startup warning. The default is 1.
BootWin=	Enables Windows 95 as the default operating system. Setting this value to 0 disables Windows 95 as the default; this is useful only with MS-DOS version 5 or 6.x on the computer. The default is 1.
DblSpace=	Enables automatic loading of DBLSPACE.BIN. The default is 1.
DoubleBuffer=	Enables loading of a double-buffering driver for a SCSI controller. The default is 0. Setting this value to 1 enables double-buffering, if required by the SCSI controller.
DrvSpace=	Enables automatic loading of DRVSPACE.BIN. The default is 1.
LoadTop=	Enables loading of COMMAND.COM or DRVSPACE.BIN at the top of 640K memory. The default is 1. Set this value to 0 with Novell® NetWare® or any software that makes assumptions about what is used in specific memory areas.
Logo=	Enables display of the animated logo. The default is 1. Setting this value to 0 also avoids hooking a variety of interrupts that can create incompatibilities with certain memory managers from other vendors.
Network=	Enables Safe Mode With Networking as a menu option. The default is 1 for computers with networking installed. This value should be 0 if network software components are not installed.

Tip for Starting an Earlier Version of MS-DOS

If you installed Windows 95 in its own directory, the earlier version of MS-DOS is preserved on your hard disk. If you set **BootMulti=1** in the [Options] section in the Windows 95 version of MSDOS.SYS, you can start the earlier version of MS-DOS by pressing F4 when the Starting Windows message appears during system startup.

Setup Technical Discussion
System Startup Files

CONFIG.SYS and AUTOEXEC.BAT

For Windows 95, both the content and method have changed for handling CONFIG.SYS and AUTOEXEC.BAT during system startup. Windows 95 automatically loads drivers and sets defaults by using IO.SYS, the Registry, and other mechanisms, rather than CONFIG.SYS and AUTOEXEC.BAT.

However, computers that require certain real-mode drivers or TSRs will continue to require that software be loaded from these configuration files. Also, CONFIG.SYS and AUTOEXEC.BAT might be required to enable certain software options. However, some options, such as long command lines, can also be enabled by using the COMMAND.COM program properties, as shown in the following illustration.

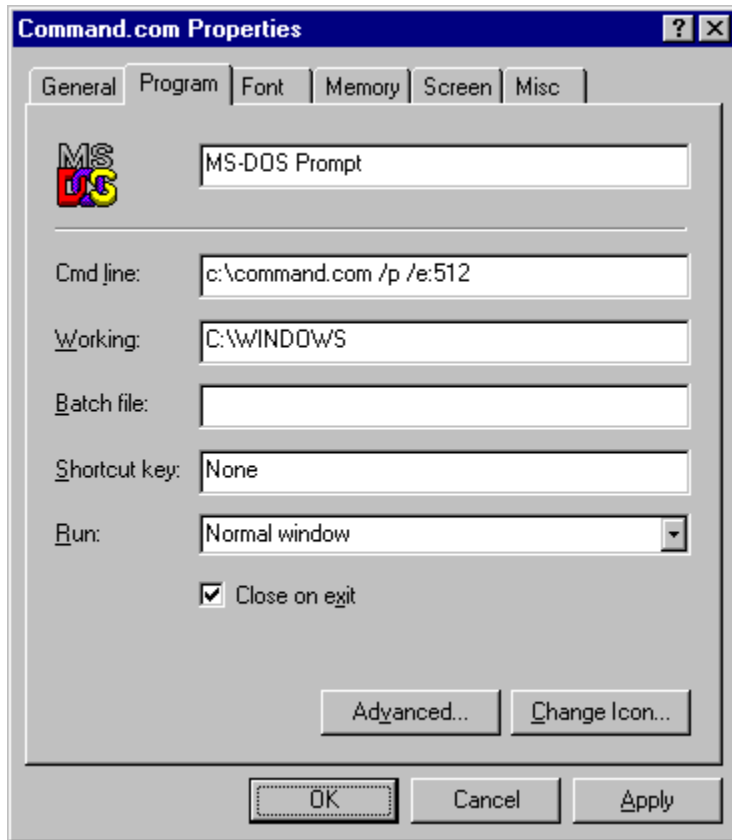

Setup Technical Discussion

System Startup Files

CONFIG.SYS and AUTOEXEC.BAT

CONFIG.SYS Processing

CONFIG.SYS defaults are implemented by IO.SYS, as described in the previous section. However, CONFIG.SYS can contain application-specific entries in addition to information stored in IO.SYS. These are processed in the sequence they are listed. After the base CONFIG.SYS file has been read, all devices are loaded, and COMMAND.COM is running.

Windows 95 loads memory managers supplied by other vendors if they are present in CONFIG.SYS; however, some might cause errors. Similarly, Windows 95 allows the use of command shells from other vendors, but, for example, long filenames are disabled, which might also indicate that other problems can occur using these command shells.

CONFIG.SYS Changes for Windows 95

Windows 95 has predefined settings built in for most common CONFIG.SYS settings, so Windows 95 Setup removes many of these lines (such as settings for **files**, **buffers**, and **stacks**) if they are equivalent to the default values, by using REM to comment out the line.

Tips for Editing CONFIG.SYS

If you edit CONFIG.SYS in Windows 95, observe the following basic guidelines:

- Do not include the **smartdrv** command. Windows 95 includes built-in disk-caching, and double-buffering is now provided by DBLBUFF.SYS.
- Remove any **device=mouse.sys** lines or similar lines. Windows 95 includes built-in mouse support.

The following tables describe the changes that Setup makes to CONFIG.SYS.

Device Entries Deleted from CONFIG.SYS if Found

cmd640x.sys	fastopen.exe	share.com	smartdrv.exe
ifshlp.sys	rambios.sys	share	
fastopen	share.exe	smartdrv.sys	

Lines Removed from CONFIG.SYS for Non-MS-DOS Operating Systems

delwatch.exe	hidos.sys	pckwik.sys	touch.exe
delpurge.exe	lock.exe	rendir.exe	vdisk.sys
diskmap.exe	login.exe	script.exe	xdel.exe
diskopt.exe	memmax.exe	superpck.exe	xdir.exe
dpms.exe	nwcache.exe	taskmax.exe	
emmxma.sys	password.exe	taskmgr.exe	

Miscellaneous Lines Removed from CONFIG.SYS

biling.sys	island.sys	nav_.sys	tcpdrv.dos
country	jdisp.sys	navtsr.exe	ubxps.dos
cpqcm.sys	jfont.sys	nemm.dos	undelete.exe
display.sys	jkeyb.sys	nfs-ndis.sys	vaccine.exe
dos-up.sys	kkcfunc.sys	pcnfs.sys	vdefend.com
dosdata.sys	kkfunc.sys	pcshel.exe	vdefend.sys
doshost.exe	memdrv.exe	pcshell	virstop.exe
driver.sys	mirror	protman.sys	vsafe.com
dwcfgmg.sys	mirror.com	rambios.sys	vsafe.sys
ega.sys	mirror.exe	redirect.sys	vwatch.com
extrados.max	msime.sys	sockdrv.sys	wbide
isl850.sys	msimek.sys	st-dbl.sys	workgrp.sys
isl861.sys	nav.driv	st-dspc.sys	

Lines Removed from CONFIG.SYS That Start Disk Caches

cache-at.sys	Golden Bow Systems software
cacheclk.exe	
cache-em.sys	Golden Bow Systems software
cache.exe	Disk cache utility
faste.exe	
fastx.exe	
fast512.sys	
flash.exe	Flash disk cache utility

hyper286.exe	Hyper disk cache utility
hyper386.exe	Shareware disk cache
hyperdkc.exe	Hyper disk cache utility
hyperdke.exe	Hyper disk cache utility
hyperdkx.exe	Hyper disk cache utility
ibmcache.sys	
icache.sys	
l.com	Lightning disk cache
mcache.sys	Paul Mace utilities
ncache.exe	Norton Utilities® disk cache utility
pc-cache.com	PC Tools™ disk cache utility
pckkey.exe	Multisoft Super PC-Kwik Windows driver
pckscrn.exe	Multisoft Super PC-Kwik Windows driver
pc-kwik.exe	PC-Kwik disk cache utility
pckwin.sys	Multisoft Super PC-Kwik Windows driver
poweron.bat	Batch file that turns on Super PC-Kwik
qcache.exe	386MAX® disk cache utility
qcache.win	386MAX/BlueMAX™ disk cache utility
scpcdext.exe	Norton CD-ROM Cache
scplus.exe	SpeedCache for disks and CD-ROM
sdcdext.exe	Norton CD-ROM Cache
speedrv.exe	Norton Speed Drive
super.exe	Super PC-Kwik
superon.bat	Batch file that turns on Super PC-Kwik
superpck.exe	Multisoft Super PC-Kwik disk cache
zcache.sys	Zenith Data Systems OEM disk cache from DOS 3.3 and 4.01

Lines Removed from CONFIG.SYS for Previous Versions of OEM-DOS

astcache.sys	AST® 3.30
cache.sys	COMPAQ® 3.20, Dell® 3.30
acher.sys	AST 3.30, Olivetti® 3.30
cemm.exe	MS-DOS 3.20, 3.21, 3.30, 3.31, 4.00
cemmp.exe	MS-DOS 3.20, 3.21, 3.30, 3.31, 4.00, COMPAQ 5.00
enhdisk.sys	COMPAQ 3.20, 3.31, 4.00
emmdrv.sys	NCR® 3.30
fastdisk.sys	AST 3.30
hardrive.sys	HP® 3.20, 3.30, 4.00
hpdcache.sys	HP 4.0
kboard.sys	Toshiba® 3.20
mlpart.sys	Tandy® 3.20, 3.30
olicache.sys	Olivetti 3.30
ramboost.exe	IBM 6.3
shelldrv.sys	NCR 3.30
spooler.sys	Tandy 3.20, 3.30
xdisk.sys	Unisys® 3.20

xma2ems.sys MS-DOS 4.00
xmaem.sys MS-DOS 4.00
zspool.sys Zenith Data Systems 3.20, 3.21

Setup Technical Discussion

System Startup Files

CONFIG.SYS and AUTOEXEC.BAT

AUTOEXEC.BAT Processing

AUTOEXEC.BAT is not required for Windows 95, but it is included for compatibility purposes. If the computer has an AUTOEXEC.BAT file, each line is processed in sequence during system startup. AUTOEXEC.BAT can contain additional application-specific entries that are run in the sequence they are listed.

Windows 95 passes the initial environment to COMMAND.COM with the correct Windows and Windows COMMAND directories already in the path and with the environment variables PROMPT, TMP, and TEMP already set. (**TEMP=** and **TMP=** indicate locations for temporary directories; both are specified for compatibility reasons.)

The following AUTOEXEC.BAT commands have equivalent default settings created in IO.SYS for Windows 95.

AUTOEXEC.BAT Equivalents for Windows 95 IO.SYS Default Settings

Command	Meaning
net start	Loads the real-mode network components and validates the binding. Any errors received are placed in the NDISLOG.TXT file. (SYSINIT or COMMAND.COM performs the necessary net start command.)
set path	Sets the path as specified.

The default Windows 95 environment includes the following:

```
tmp=c:\windows\temp  
temp=c:\windows\temp  
prompt=$p$g  
path=c:\windows;c:\windows\command  
comspec=c:\windows\command\command.com
```

AUTOEXEC.BAT Changes for Windows 95

Windows 95 Setup makes the following basic changes to AUTOEXEC.BAT:

- Updates the **path=** line statement
- Uses **rem** to comment out incompatible TSRs
- Deletes any **win** statement (or equivalent) and SHARE.EXE
- Copies the original AUTOEXEC.BAT to AUTOEXEC.DOS
- Sets the TEMP directory

For diskless workstations, if the TEMP and TMP environment variables are not set, Windows 95 Setup creates a TEMP directory in the home directory (which can be on the local hard disk or on the network), and adds **set tmp=** and **set temp=** entries in AUTOEXEC.BAT that point to the new directory.

Tips for Editing AUTOEXEC.BAT in Windows 95

If you edit AUTOEXEC.BAT, observe the following basic guidelines:

- Do not include other versions of Windows in your path.
- Start the path with C:\WINDOWS;C:\WINDOWS\COMMAND (using the name for the Windows 95 directory on your hard disk if it is not WINDOWS).
- Windows 95 Setup leaves your previous MS-DOS directory in the path. Do not change this.
- Do not add SMARTDrive or other disk caches. Windows 95 includes built-in caching.
- Do not include any statements for loading mouse support software. Windows 95 includes built-in mouse support.
- If it is necessary to connect to a network server when you start Windows 95, create a batch file, and run it from the STARTUP directory, rather than placing an entry in AUTOEXEC.BAT.

The following tables describe changes that Setup makes to AUTOEXEC.BAT. For entries that are removed, Setup uses **rem** to comment out the line.

Commands Removed from AUTOEXEC.BAT

dosshell	setcfg	UnSet=comspec	=ascsi
fastopen	share	win	

Commands Removed from AUTOEXEC.BAT for Non-MS-DOS Operating Systems

delpurge	dpms	nwcache	taskmax
delq	eraq	password	taskmgr
delwatch	lock	ramboost	touch
diskmap	login	rendir	xdel
diskopt	memmax	script	xdir

Miscellaneous Lines Removed from AUTOEXEC.BAT

3C503ban	diagintr	irmban	rinAsync
3C507ban	diagipa	isoban	script
3C523ban	diagiso	mirror	snban
3C603ban	diagomni	navtsr.exe	sockets
6510ban	diagpcnt	ndarcban	tcptsr
8023ban	diagpro4	nddgban	tinyrfc
acinfo	diagtokn	neban	tokbanmc
arcban	diagungr	net	toknban
arcmban	diagvlan	netbind	tokuiban
asyncban	diagwd	netbind	trban

attstban	dnr	nicmcbn	ubniuban
call	doshost	nmtsr	umb
csiban	drvspace,1	oliban	undelete,1
dblspc,1	emsbfr	omniban	ungerban
dellmenu,1	etherban	pcnetban	vaccine
diag5210	expban	pcshell	vdefend
diag9210	hughsban	pro16ban	virstop.exe
diagarc	i92ban	pro4ban	vlanban
diage503	intelban	proban	vsafe.com
diage523	interban	probanmc	vwatch.com
diage603	intr2ban	redirect	wbide
diagethr	ipaban	rin	wdban

Lines Removed from AUTOEXEC.BAT That Start Disk Caches

Command line	Disk cache
cache-at	Golden Bow Systems software
cachechk	Helix Multimedia Cloaking version 1.0
cache-em	Golden Bow Systems software
cache	
fast	
faste	
fastx	
fast512	
flash	Flash disk cache utility
hyper286	Hyper disk cache utility
hyper386	Shareware disk cache
hyperdkc	Hyper disk cache utility
hyperdke	Hyper disk cache utility
hyperdkx	Hyper disk cache utility
ibmcache	
icache	
l	Lightning disk cache
mcache	Paul Mace utilities
ncache	Norton Utilities disk cache utility
ncache2	Norton Utilities disk cache utility
pc-cache	PC Tools disk cache utility
pckkey	Multisoft Super PC-Kwik Windows driver
pckscrn	Multisoft Super PC-Kwik Windows driver
pc-kwik	PC-Kwik disk cache utility
pckwin	Multisoft Super PC-Kwik Windows driver
poweron.bat,1	Super PC-Kwik
qcache	386MAX disk cache utility
scpcdext	Norton CD-ROM cache
scplus	SpeedCache for disks and CD-ROM
sdcdext	Norton CD-ROM cache
smartdrv	Microsoft SMARTDrive disk utility
speedrv	Norton Speed Drive
super	Super PC-Kwik

superon	Batch file that turns on Super PC-Kwik
superpck	Multisoft Super PC-Kwik disk cache
zcache	Zenith Data Systems OEM from DOS 3.3 and 4.01

Setup Technical Discussion

System Startup Files

SYSTEM.INI and WIN.INI

This section describes changes related to system startup made by Windows 95 Setup to SYSTEM.INI and WIN.INI. Mappings for other changes between Windows 3.x and Windows 95 are described in [Windows 95 Registry](#).

Changes to SYSTEM.INI

Most configuration options for Windows 95 are now stored in the Registry and are no longer required in SYSTEM.INI. The following options have been moved to the Registry or are no longer valid in Windows 95:

- All parameters are moved from the [Network drivers] section of SYSTEM.INI to the Registry.
- The **lanabase=** parameter is moved from the [nwnblink] section of SYSTEM.INI to the Registry.

The following tables describe other changes made in SYSTEM.INI.

Entries Added to the [Boot] Section of SYSTEM.INI

comm.driv=comm.driv	gdi.exe=gdi.exe	user.exe=user.exe
dibeng.driv=dibeng.dll	sound.driv=sound.driv	

Entries Added to the [386Enh] Section of SYSTEM.INI

device=*vshare	device=*int13
device=*vcd	device=*dynapage

Entries Deleted in the [386Enh] Section of SYSTEM.INI

device=*vfd	device=lpt.386	device=isapnp.386
device=*configmg	device=pagefile.386	device=wshell.386
device=serial.386	timercriticalsection=	maxbps=

Entries Moved from the [386Enh] Section of SYSTEM.INI to the Registry

Network=	SecondNet=	V86ModeLANAs=
Network3=	Transport=	

Entries Moved from the [Network] Section of SYSTEM.INI to the Registry

AuditEnabled=	FileSharing=	PasswordCaching=
AuditEvents=	LANAs=	PrintSharing=
AuditLogSize=	LMAnnounce=	Reshare=
AutoLogon=	LMLogon=	SlowLanas=
Comment=	LogonDisconnected=	Winnet=
ComputerName=	LogonDomain=	Workgroup=
DirectHost=	LogonValidated=	
EnableSharing=	Multinet=	

The following list summarizes where you should set the related parameters using Windows 95 tools:

- Set all memory-related parameters by using the System option in Control Panel. For information, see [Performance Tuning](#).
- Set parameters for hardware devices by using Device Manager in the System option in Control Panel. For information, see [Devices](#).
- Set all networking and resource sharing parameters by using the Network option in Control Panel. For information, see [Networking](#).

Changes to WIN.INI

The font and desktop information in WIN.INI is transferred to the Registry, as described in the following lists.

Entries Moved from the [Windows] Section of WIN.INI to the Registry

Beep	KeyboardDelay	MouseSpeed
BorderWidth	KeyboardSpeed	ScreenSaveActive
CursorBlinkRate	MouseThreshold1	ScreenSaveTimeOut
DoubleClickSpeed	MouseThreshold2	SwapMouseButtons

Entries Moved from the [WindowMetrics] Section of WIN.INI to the Registry

BorderWidth	MinArrange	ScrollHeight
CaptionHeight	MinHorzGap	ScrollWidth
CaptionWidth	MinVertGap	SmCaptionHeight
MenuHeight	MinWidth	SmCaptionWidth
MenuWidth		

In addition, Setup always adds **ATMWorkaround=1** to the [Pscript.Drv] section in WIN.INI.

The following list summarizes where you should set the related parameters using Windows 95 tools:

- Set all mouse parameters by using the Mouse option in Control Panel. For information, see [Devices](#).
- Set parameters for the keyboard by using the Keyboard option in Control Panel. For information, see online Help.
- Set all screen and window display parameters by using the Display option in Control Panel. For information, see [Devices](#).

BOOTLOG.TXT: The Startup Process Log

The BOOTLOG.TXT file contains a record of the current startup process for starting Windows 95. This file is created during Setup when the Windows 95 operating system is first started from Windows 95 Setup. This file shows the Windows 95 components and drivers loaded and initialized, and the status of each.

When you use the F8 option for interactive system startup, you can choose to create a boot log during system startup. You can also use the **/b** switch to create a boot log when running WIN.COM from the command line to isolate configuration problems. For information, see [General Troubleshooting](#).

The information in BOOTLOG.TXT is written in sequence during startup, in roughly five major sections. Depending upon a specific error condition, you might need to examine multiple sections. Notice, however, that a **loadfailed=** entry means only that the related VxD refused to load. For example, **loadfailed=ebios** indicates that the EBIOS driver did not detect EBIOS in the computer and so reported that it should not be loaded. The following table shows the sections to examine, and describes the possible errors and methods for correcting those errors.

BOOTLOG.TXT Sections for Determining Errors**Section and errors Corrective action****Loading real-mode drivers:**

No XMS memory	Verify that the section contains this entry: <code>loadsucces=c:\windows\himem.sys</code> If not, verify the file and entry in CONFIG.SYS
Incorrect MS-DOS version (message appears when driver loads)	If this error appears when loading drivers or programs that worked before, verify that the section contains this entry: <code>loadsucces=c:\windows\setver.exe.</code>
Windows 95 doesn't start on a SCSI hard drive	Verify that the section contains this entry: <code>loadsucces=c:\windows\dblbuff.sys</code>
IFSHLP.SYS message occurs	Verify that the section contains this entry: <code>loadsucces=c:\windows\ifshlp.sys</code>

Loading VxDs:

	Verify the loading, system, and device initialization of all VxDs by checking the section for these entries: <code>loading vxd = ios</code> <code>loadsucces = ios</code>
Cannot access D?? SPACE drives	Verify that the section contains this entry: <code>loadsucces = c:\dblspace.bin</code>
Sharing violations occur	Might be due to failure of the Vshare VxD to load. The section might contain an entry such as: <code>loadfailed = vshare</code>

System-critical initialization of VxDs:

System-critical initialization error occurs	Verify that this section contains entries such as: <code>syscritinit=ios</code> <code>syscritinitsuccess=ios</code>
---	---

Device initialization of VxDs:

Verify that the section contains entries such as:

```
deviceinit=ios
deviceinitsuccess=ios
```

Successful VxD initialization:

Verify that the section contains entries such as:

```
initcomplete=ios
initcompletesuccess=ios
```

The following table shows the kinds of entries in BOOTLOG.TXT to examine for information about the system startup process.

BOOTLOG.TXT entry	Description
Error	Errors that were logged during startup
Fail	Failures that occurred during startup
Dynamic load success	Dynamically loaded VxDs
InitCompleteSuccess	Loaded VxDs
LoadStart, LoadSuccess, Loading Device, Loading Vxd	Indication of loading processes
LoadFailed	Indication that component failed to load
Syscritinit, SysCritInitsuccess	System initialization actions
Deviceinit, DeviceInitsuccess	Device initialization actions
Dynamic load device, Dynamic init device	Dynamic loading and initialization of devices
Initing, Init Success, InitComplete, Init, InitDone	Initialization actions
Status	Current status indicator

For example, if you see an entry such as **DynamicInitsuccess=PPPMAC** but there is no matching entry such as **DynamicLoadSuccess=PPPMAC**, then that VxD failed to load. If a driver in the Windows SYSTEMIOSUBSYS directory stalls when it is being initialized, you can sometimes successfully start the system by renaming that file.

The following shows a sample BOOTLOG.TXT file:

```
Loading Device = C:\WINDOWS\HIMEM.SYS
LoadSuccess    = C:\WINDOWS\HIMEM.SYS
Loading Device = C:\WINDOWS\EMM386.EXE
LoadSuccess    = C:\WINDOWS\EMM386.EXE
Loading Device = C:\WINDOWS\SETVER.EXE
LoadSuccess    = C:\WINDOWS\SETVER.EXE
Loading Device = C:\WINDOWS\COMMAND\ANSI.SYS
LoadSuccess    = C:\WINDOWS\COMMAND\ANSI.SYS
Loading Device = C:\WINDOWS\IFSHLP.SYS
LoadSuccess    = C:\WINDOWS\IFSHLP.SYS
Loading Vxd    = VMM
LoadSuccess    = VMM
Loading Vxd    = nmlink.vxd
LoadSuccess    = nmlink.vxd
Loading Vxd    = vnetsup.vxd
LoadSuccess    = vnetsup.vxd
```

Windows 95 Setup with Other Operating Systems

This section presents technical details related to installing Windows 95 over an existing operating system, including changes made to system files by Windows 95 Setup and configuring for dual-booting with the previous operating system.

The following table summarizes some of the available options for upgrading with Windows 3.x, MS-DOS, and Windows NT, and whether you should install Windows 95 in a new directory or an existing Windows 3.x directory to take advantage of these options.

Upgrade versus New Installation Options

Feature	Install in a new directory	Install in existing Windows 3.x directory
Migrate existing Windows application settings and files	-	X
Dual boot Windows 95 and MS-DOS	X	-
Dual boot Windows 95 and Windows NT ¹	X	-

¹ Windows 95 and Windows NT can work together properly if the computer is configured for dual booting between MS-DOS and Windows NT. However, you must install Windows 95 in a new directory.

The issues discussed in this section include the following:

- Installing Windows 95 over Windows 3.x, plus installing for dual booting with Windows 3.x
- Installing Windows 95 over MS-DOS, including running on multiple-configuration computers
- Installing Windows 95 for dual-booting with Windows NT
- Installing Windows 95 over Novell® DR DOS®
- Installing Windows 95 over IBM® OS/2®

Installing Windows 95 over Windows 3.x

If you have Windows 3.x or Windows for Workgroups 3.x, you can either upgrade the current installation to Windows 95 (the preferred method) or install this version of Windows 95 in a new directory.

If you choose to upgrade your existing Windows installation, Windows 95 Setup uses existing configuration information to set installation defaults and to set other configuration options. Windows 95 Setup converts all Windows 3.x Program Manager groups to folders inside the Programs directory, so they appear on the Windows 95 Start menu. These folders can be opened or explored to find the applications previously contained in them. Windows 95 automatically creates a shortcut for each original icon you had under the previous version of Windows.

Windows 95 Setup checks for the following files to determine whether the current installation is an upgrade to Windows 3.x: WINVER.EXE, USER.EXE, WIN.COM, SYSTEM.INI, and WINI.INI, plus PROTOCOL.INI for Windows for Workgroups 3.x. When searching for these files, Windows 95 Setup also checks the files for version information. (False files with the same name won't work.)



To upgrade from Windows 3.1 or Windows for Workgroups to Windows 95

1. Start Windows 3.1 or Windows for Workgroups on your computer.
2. Insert the first Windows 95 Setup floppy disk or the compact disc in the appropriate disk drive.

-Or-

Connect to the shared network resource that contains the Windows 95 source files.

3. In File Manager, select the disk drive you used in step 2.
4. Click the File menu, click Run, and then type **setup**

All of your current system settings (such as program groups and desktop preferences) are moved automatically to Windows 95. Windows 95 Setup also saves settings so that you can continue to use the network configuration that you had previously.



To upgrade from Windows 3.0

1. Start your computer with MS-DOS. Do not run Windows 3.0.
2. Insert the first Windows 95 Setup floppy disk or the compact disc in the appropriate disk drive.

-Or-

Connect to the shared network resource that contains the Windows 95 source files.

3. Switch to the directory that contains the Windows 95 source files. At the command prompt, type **setup** and follow the directions on screen.

Installing Windows 95 for Dual Booting with Windows 3.x

To install Windows 95 with dual-boot capabilities for MS-DOS, the computer must already be running version 5.x or 6.x of MS-DOS or PC-DOS.

Important In order to take advantage of the Windows 95 dual-boot capabilities, the entry **BootMulti=1** must be set in the Windows 95 MSDOS.SYS file in the root directory. For more information, see [MSDOS.SYS: Special Startup Values](#).



To set up dual-boot capabilities for a new installation of Windows 95

- During Windows 95 Setup, when you are installing Windows 95 for the first time, make sure you specify a new directory that does not already have another version of Windows in it.

Windows 95 Setup makes all of the necessary changes to preserve your existing version of MS-DOS, Windows 3.x, or Windows for Workgroups 3.x, and your current AUTOEXEC.BAT and CONFIG.SYS files.

If you have already installed Windows 95 without dual-boot capabilities, you can follow these steps to allow MS-DOS to dual boot with Windows 95. However, you will not be able to dual boot with your previous version of Windows.



To set up dual-boot capabilities after Windows 95 has been installed

1. On a bootable floppy disk that starts MS-DOS 5.0 or greater, rename the IO.SYS and MSDOS.SYS files on the disk to IO.DOS and MSDOS.DOS. Then copy these files to the root directory of your boot drive (usually drive C).

These files must be placed in the root directory. Usually these files are marked with the hidden, system, and read-only attributes, so you might need to use the MS-DOS **attrib** command on these files while they are on the floppy disk, to view and copy them (for example, type **attrib -h -s -r io.sys**).

Caution You must rename the MS-DOS versions of these files before copying them to the root directory. Otherwise, you will destroy your Windows 95 installation.

2. On a bootable floppy disk that starts MS-DOS 5.0 or greater, rename the COMMAND.COM file on the disk to COMMAND.DOS. Then copy this file to the root directory of your boot drive.

Note If you are using disk compression software, you need to copy IO.DOS, MSDOS.DOS, COMMAND.DOS, CONFIG.DOS, and AUTOEXEC.BAT to your host drive also.

3. Use a text editor to create CONFIG.DOS and AUTOEXEC.DOS files that are appropriate for the MS-DOS version that you are using and store them in the root directory.
4. To use Windows 95 or the earlier version of MS-DOS in the usual way, restart the computer.

Installing Windows 95 over MS-DOS

The versions of MS-DOS supported for installing Windows 95 are versions 3.2 or greater (for partitions that are greater than 32 MB), 4.x, 5.x, and 6.x.

Tip for Running MS-DOS After Windows 95 Is Installed

If you install Windows 95 in a different directory from the one containing your previous Windows 3.x version, you can start the computer by using the previous version of MS-DOS. To do this, make sure the entry **BootMulti=1** is in the Windows 95 MSDOS.SYS file, and then press F8 during system startup and choose the related option.

Files Deleted by Windows 95 Setup

This section lists MS-DOS and other files that are deleted by Windows 95 Setup. Notice, however, that these files are deleted from the old MS-DOS directory only if you install Windows 95 in the existing Windows 3.x directory. Otherwise, the old MS-DOS files are all preserved so that you can start the computer using the older version of MS-DOS.

The Windows 95 command-line commands are stored in the COMMAND subdirectory of the Windows directory. Deleting the related MS-DOS command file will not affect your ability to use the command under Windows 95. The versions that are deleted by Setup are known to be incompatible with Windows 95; for example, many of these MS-DOS commands do not support long filenames.

MS-DOS and Windows 3.x Files Deleted by Windows 95 Setup

ansi.sys	d??space.exe ¹	keyb.com	ramdrive.sys
attrib.exe	d??space.sys ¹	keyboard.sys	readme.txt
chkdsk.exe	edit.com	label.exe	scandisk.exe
choice.exe	edit.hlp	mem.exe	scandisk.ini
country.sys	ega.cpi	mode.exe	setver.exe
debug.exe	emm386.exe	more.com	share.exe
defrag.exe	fc.exe	move.com	smartdrv.exe
deltree.exe	fdisk.exe	mscdex.exe	sort.exe
diskcopy.exe	find.exe	msd.exe	start.exe
display.sys	format.com	networks.txt	subst.exe
doskey.com	help.com	nlsfunc.exe	sys.com
d??space.bin ¹	help.hlp	os2.txt	xcopy.exe

¹ DRVSPACE.* or DBLSPACE.*

COMPAQ DOS 5.0 Files Deleted by Windows 95 Setup

cache.exe	dos5help.chd	fsedit.exe	tu.exe
cemm.exe	fastart.exe	help.exe	upcu.exe
cemmp.exe			

Non-MS-DOS Operating System Files Deleted by Windows 95 Setup

delpurge.exe	hidoss.sys	rendir.exe	touch.exe
delwatch.exe	lock.exe	setup.exe	uninstal.exe
diskmap.exe	login.exe	sys.com	xdel.exe
diskopt.exe	memmax.exe	taskmax.exe	xdir.exe
dosbook.exe	password.exe	taskmax.ini	

Pre-MS-DOS 5.0 Files Deleted by Windows 95 Setup

append.com	enhdisk.sys	keybfr.exe	print.exe
------------	-------------	------------	-----------

asgnpart.com	fastopen.exe	keybgk.com	recover.exe
backup.exe	fastart.exe	keybgr.com	restore.exe
bootf.com	fdisk.com	keybgr.exe	select.com
cache.sys	filesys.exe	keybit.com	select.dat
cemm.exe	for150.exe	keybit.exe	select.exe
cemmp.exe	format.exe	keybno.com	select.hlp
chkdsk.exe	gdu.exe	keybsp.com	select.prt
cmpqadap.com	graftabl.exe	keybsv.exe	select1.dat
compact.exe	graphics.exe	keybsw.com	select2.dat
configur.com	hardrive.sys	keybuk.com	setup.exe
debug.exe	hpcache.com	keybuk.exe	shell.clr
detect.com	hpdcache.com	keybus.com	shell.hlp
diskcomp.exe	ifsfunc.exe	label.exe	shell.meu
diskcopy.exe	indskbio.sys	mode.exe	shellb.com
diskinit.com	install.exe	mvbuild.exe	shellc.exe
diskinit.exe	keyb32.com	pamcode.com	tree.exe
dosutil.meu	keybchf.com	paminstl.com	vdisk.sys
dskscan.exe	keybchg.com	part.exe	xmaem.sys
dsksetup.com	keybda.com	password.exe	zcache.sys
edlin.exe	keybfr.com	prep.exe	zspool.com
emm386.sys			

Setup Technical Discussion

Windows 95 Setup with Other Operating Systems

Installing Windows 95 over MS-DOS

System Startup with MS-DOS Multiple Configurations

Windows 95 supports multiple configurations for the same computer, and it dynamically determines which configuration is being used. If Windows 95 cannot determine the specific configuration used during system startup before processing CONFIG.SYS, then it presents a menu of available configurations as listed in the Registry, and it prompts you to select the configuration you want.

If you have a multiple configuration established in CONFIG.SYS, that menu is presented next. However, if you use a multiple configuration to switch between different versions of Windows, you must edit CONFIG.SYS manually to repair this configuration after Windows 95 is installed. For information about how to create multiple configurations for the same computer under Windows 95, see [Devices](#).

Installing Windows 95 for Dual Booting with Windows NT

You can install Windows 95 to dual boot with Windows NT on a computer. This section provides some notes for installing Windows 95 with Windows NT.

Important In order to take advantage of the Windows 95 dual-boot capabilities, the entry **BootMulti=1** must be set in the Windows 95 version of MSDOS.SYS file in the root directory of your startup drive. For more information, see [MSDOS.SYS: Special Startup Values](#).



To install Windows 95 to dual boot with Windows NT

1. Ensure that the computer is configured to dual boot between Windows NT and MS-DOS. Check your Windows NT documentation for details.
2. Start the computer by using the MS-DOS operating system.
3. Run Windows 95 Setup as described in [Introduction to Windows 95 Setup](#).

Remember that if your computer has any Windows NT file system (NTFS) partitions, they are not available locally from within Windows 95.

If you run MS-DOS from a floppy disk in order to install Windows 95, you will not be able to start Windows NT afterward. You can restore the multiboot configuration by starting the computer with your Windows NT emergency repair disk and selecting the Repair option.

To run MS-DOS after Windows 95 has been installed, you must select the MS-DOS option from the Windows NT multiboot menu. Then, from the Windows 95 Startup menu, select the Previous Version of MS-DOS option.



To install Windows NT on a computer where Windows 95 is installed

- At the command prompt, switch to the directory that contains the Windows NT source files, and then type **winnt /w**

The WINNT program is an MS-DOS-based application that creates the Windows NT Setup startup files and copies the system files to the hard disk from the source files. The **/w** switch allows WINNT to run under Windows. Using this switch also causes Windows NT Setup to skip the CPU detection process and the automatic restart at the end of Setup. You can also include the **/b** switch to copy the required startup files for Setup so that you do not have to create floppy disks for Setup.

For more information about the Windows NT operating system and about running computers with Windows 95 on a Windows NT network, see [Windows 95 on Microsoft Networks](#).

Setup Technical Discussion

Windows 95 Setup with Other Operating Systems

Installing Windows 95 over DR DOS

DR DOS is a disk operating system manufactured by Novell. The latest version of Novell DOS™ available at the release of Windows 95 was version 7.

You cannot configure dual-boot capabilities for Windows 95 and DR DOS.

Windows 95 Setup checks for the following DR DOS files that could cause conflicts.

DR DOS Files That Cause Conflicts

delwatch.exe	fastopen.exe	rendir.exe	taskmax.exe
delpurge.exe	lock.exe	script.exe	touch.exe
diskmap.exe	memmax.exe	superpck.exe	xdel.exe
diskopt.exe	password.exe		

DR DOS is upgraded in the same way as versions of MS-DOS (as described earlier in this section). However, these additional changes are made during Windows 95 Setup:

- Some DR DOS utilities can cause compatibility problems with the Windows 95 real-mode kernel; Windows 95 Setup uses **rem** to comment out any command lines in the configuration files that start such utilities.
- If you use DR DOS password protection, Windows 95 Setup warns that this should be removed; otherwise, Windows 95 Setup cannot use the protected volume.

Setup Technical Discussion

Windows 95 Setup with Other Operating Systems

Installing Windows 95 over OS/2

You can install Windows 95 on a computer running any version of OS/2 as long as a FAT partition is available. If the computer has any HPFS partitions, these partitions are not available from within Windows 95. Setup reminds you of this when it detects an HPFS partition.

The following notes apply to installing Windows 95 on a computer running OS/2:

- You must install Windows 95 in a new directory.
- Windows 95 Setup cannot migrate desktop or other settings from OS/2.
- You might have to reinstall any Windows-based applications to run under Windows 95.

Windows 95 Setup cannot run from within either OS/2 or OS/2 for Windows. You must start the computer by using MS-DOS and then run Windows 95 Setup from an MS-DOS command prompt. If your OS/2 system is not configured to dual boot with MS-DOS, install MS-DOS first, and then start Windows 95 Setup from MS-DOS.

If your computer has OS/2 Boot Manager, a message warns you that continuing with Windows 95 Setup will disable Boot Manager. If you choose to continue, Windows 95 Setup removes the OS/2 Boot Manager partition information because Windows 95 Setup cannot determine which operating system or configuration Boot Manager will use to restart the computer. This ensures that Windows 95 starts during the installation process.

Windows 95 Setup leaves all other OS/2 files intact and does not remove any files from the OS/2 directory.

Tip for Restoring Boot Manager After Windows 95 Is Installed

Windows 95 runs normally with Boot Manager after installation is complete. After Windows 95 is installed, you can make Boot Manager active again by using the OS/2 boot disk to run the OS/2 Fdisk utility.

Setup Technical Discussion

Removing Windows 95 from a Computer

Windows 95 can be removed from a computer by using the procedures described in the following section. If the computer is configured for dual booting, you will be left with the previous versions of MS-DOS and Windows 3.x intact. If you upgraded Windows 3.x, then you will need to reinstall Windows 3.x after Windows 95 is removed.

The recommended method for removing Windows 95 is to start the computer and use the F8 key to get to a command line, as described in the following procedure. When this is done, real-mode Windows 95 operating system files start the computer. If you encounter problems starting Windows 95 in this way, start your computer from the previous operating system (which might require using a floppy disk).

Removing Windows 95 with Command-Line Startup

Before you begin this process, make sure you have a system startup disk that contains an earlier version of MS-DOS and the SYS.COM file. You need this startup disk because the Windows 95 startup files (real-mode operating system files) must be deleted, so the process for removing Windows 95 makes your hard disk temporarily unbootable.

Note The MS-DOS 6.x disk #1 is bootable, but the retail MS-DOS 5.0 disk #1 is not, and OEM versions might vary. To make a startup disk with MS-DOS 6.x, run **setup /f** from disk #1.



To remove Windows 95 when the computer is started to the command line

1. Start the computer and press F8 when the Starting Windows message appears.

If you have problems starting the computer in this way, you can use the procedure entitled [Removing Windows 95 with Your Previous Operating System](#).

2. Select the Command Prompt Only option.
3. To make it easier to delete files and directories, copy the Windows 95 version of DELTREE.EXE to the boot drive. At the command prompt, type:

```
copy \windows\command\deltree.exe c:\
```

4. To use the Windows 95 version of ScanDisk to clear invalid entries and long filenames, copy the ScanDisk files from the Windows COMMAND directory to the root directory. At the command prompt, type:

```
copy \windows\command\scandisk.* c:\
```

5. Use Notepad or a similar text editor to edit SCANDISK.INI in the Windows directory. Change the entries controlling whether ScanDisk looks for invalid characters in filenames and volume labels:
 - Set **labelcheck=on** to specify that ScanDisk should check volume labels for invalid characters.
 - Set **spacecheck= on** to specify that ScanDisk should check for invalid spaces in filenames.

For information about the entries in SCANDISK.INI, see that file in the Windows directory.

6. To remove all entries that your earlier version of MS-DOS might see as invalid, at the command prompt, type **scandisk** followed by the letter identifying the drive containing the Windows 95 installation. For example:

```
scandisk c:
```

If you receive error messages during the ScanDisk process, refer to the online Help for information to help you resolve the error.

7. To delete the Windows 95 directory, in the root directory of the drive containing the Windows 95 installation, type:

```
deltree windows
```

In this command, *windows* is the name of the directory containing the Windows 95 files.

Caution All subdirectories of the Windows 95 directory will be deleted by this command. Before performing this step, make sure that the Windows 95 directory tree does not contain any critical data that has not been backed up.

This step will also require that you reinstall all Windows-based programs at the end of this procedure, so that the correct drivers and settings will be available in the restored Windows directory.

8. To delete the Windows 95 CONFIG.SYS and AUTOEXEC.BAT files, in the root directory of the boot drive, type:

```
deltree config.sys  
deltree autoexec.bat
```

9. To delete the WINBOOT.INI file and the WINBOOT directory, if present, type:

```
deltree winboot.*
```

10. To delete the setup, boot, and detection log files, type:

```
deltree setuplog.*
```

deltree bootlog.*

deltree detlog.*

11. To delete the real-mode operating system files IO.SYS and MSDOS.SYS, in the root directory of the boot drive (or from the root directory of the host drive, if the boot drive is compressed), type:

deltree io.sys

deltree msdos.sys

12. If you are using STAC Electronics Stacker® version 3.1, either skip this step or back up the STAC DBLSPACE.BIN file before completing this step.

To delete the Windows 95 compression drivers (DBLSPACE.BIN and DRVSPACE.BIN), if present, in the root directory of the boot drive (or from the root directory of the host drive, if the boot drive is compressed), type:

deltree d??space.bin

13. To delete the Windows 95 command processor (COMMAND.COM), in the root directory of the boot drive (or both from the C drive and from the root of the host drive, if the boot drive is compressed), type:

deltree command.com

14. Put a bootable floppy disk with your earlier version of MS-DOS into drive A, and then restart the computer. After the computer starts from the floppy disk, put your earlier version of MS-DOS back on the boot drive (or the host drive, if the C drive is compressed) by typing **sys** followed by the letter identifying the boot or host drive and a colon. For example:

sys c:

15. If you have MS-DOS version 6.0 and are using compression, copy DBLSPACE.BIN from the DOS directory to the root directory of the boot drive. Also, for all versions of MS-DOS, if you have a **shell=** statement referencing COMMAND.COM from a different directory, copy COMMAND.COM to the root directory. Then remove the floppy disk, and restart the computer from the hard disk.

To start the system with previous configuration files, copy CONFIG.DOS to CONFIG.SYS and AUTOEXEC.DOS to AUTOEXEC.BAT.

If you remove Windows 95 from a dual-boot installation, Windows 95 will be removed completely, and the computer will start the same way it did before installing Windows 95.

If you removed Windows 95 from an upgraded Windows 3.x installation, drivers that were located in the Windows directory (such as HIMEM.SYS, IFSLHLP.SYS, and EMM386.EXE) will be missing until you reinstall Windows 3.x. Then the computer will start the same way it did before Windows 95 was installed.

You might need to reinstall the previous version of MS-DOS, if needed files were removed by Windows 95 Setup.

Removing Windows 95 with Your Previous Operating System

Use this procedure if you cannot start a computer in Windows 95 real mode, as described in the preceding section.

Before you begin this process, make sure you have a bootable floppy disk that contains an earlier version of MS-DOS and the SYS.COM file. The process for removing Windows 95 makes your hard disk temporarily unbootable, and the Windows 95 startup files (real-mode operating system files) must also be deleted.

Note The MS-DOS 6.x disk #1 is bootable, but the retail MS-DOS 5.0 disk #1 is not, and OEM versions might vary. To make a startup disk with MS-DOS 6.x, run **setup /f** from disk #1.



To remove Windows 95 when the computer is started with the previous operating system

1. Start the computer and press the F8 key when the Starting Windows message appears.
2. Select the Previous Version Of MS-DOS option.
3. To make it easier to delete files and directories, copy the Windows 95 version of DELTREE.EXE to the boot drive. At the command prompt, type:

```
copy \windows\command\deltree.exe c:\
```

4. To copy the Windows 95 version of ScanDisk files from the Windows COMMAND directory to the root directory, type:

```
copy \windows\command\scandisk.* c:\
```

5. Use Notepad or a similar text editor to edit SCANDISK.INI. Change the entries controlling whether ScanDisk looks for invalid characters in filenames and volume labels:

- Set **labelcheck=on** to specify that ScanDisk should check volume labels for invalid characters.
- Set **spacecheck=on** to specify that ScanDisk should check for invalid spaces in filenames.

6. To remove all entries that your earlier version of MS-DOS might see as invalid, at the command prompt, type **scandisk** followed by the letter identifying the drive containing the Windows 95 installation. For example:

```
scandisk c:
```

If you receive error messages during the ScanDisk process, refer to the online Help for information to help you resolve the error.

7. To delete the Windows 95 directory, in the root directory of the drive containing the Windows 95 installation, type:

```
deltree windows
```

In this command, *windows* is the name of the directory containing the Windows 95 files.

Caution All subdirectories of the Windows 95 directory will be deleted by this command. Before performing this step, make sure that the Windows 95 directory tree does not contain any critical data that has not been backed up.

8. To delete the Windows 95 real-mode operating system file named WINBOOT.SYS, which was renamed from IO.SYS when you started the computer with your previous operating system, type the following command from the boot drive (or from the root directory of the host drive, if the boot drive is compressed):

```
deltree winboot.*
```

9. Delete the Windows 95 files MSDOS.W40, COMMAND.W40, CONFIG.W40, and AUTOEXEC.W40 files. (The renaming of these operating system files occurred when you used F8 to start the previous operating system.) To do this, type the following command at the command prompt (if the boot drive is not compressed):

```
deltree *.w40
```

If the boot drive is compressed, you must delete MSDOS.W40 from the root directory of the host drive and COMMAND.W40 from the root directories of both the host drive and the boot drive.

10. To delete the setup, boot, and detection log files, type:

```
deltree setuplog.*  
deltree bootlog.*  
deltree detlog.*
```

11. If you are using Stacker version 3.1, either skip this step or back up the STAC DBLSPACE.BIN file before completing this step. To delete the Windows 95 compression drivers (DBLSPACE.BIN and DRVSPACE.BIN), in the root directory of the boot drive (or from the root directory of the host drive, if the boot drive is compressed), type:

```
deltree d??space.bin
```

12. Put a bootable floppy disk with the earlier version of MS-DOS into drive A, and then restart the computer. After the computer starts from the floppy disk, put the earlier version of MS-DOS back on the boot drive (or the host drive, if the C drive is compressed) by typing **sys** followed by the letter identifying the drive and a colon. For example:

```
sys c:
```

13. If you have MS-DOS version 6.0 and are using compression, copy DBLSPACE.BIN to the root directory of the boot drive. Also, for all versions of MS-DOS, if you have a **shell=** statement referencing COMMAND.COM from a different directory, copy COMMAND.COM to the root directory. Then remove the floppy disk, and restart the computer from the hard disk.

If you remove Windows 95 from a dual-boot installation, Windows 95 will be removed completely, and the computer will start the same way it did before installing Windows 95.

If you removed Windows 95 from an upgraded Windows 3.x installation, you might need to reinstall your previous version of MS-DOS if some of the necessary files were removed by Windows 95 Setup. Drivers that were located in the Windows directory (such as HIMEM.SYS, IFSLHLP.SYS, and EMM386.EXE) will be missing until you reinstall Windows 3.x into the Windows directory. After you have reinstalled Windows 3.x, the computer will start the same way it did before Windows 95 was installed.



To remove Windows 95 from a computer with Windows NT installed

1. Follow the steps in the procedure named "To remove Windows 95 when the computer is started with the previous operating system" earlier in this section.
2. Use the Windows NT Setup disk #1 to restart your computer.
3. When prompted, choose Repair. Then insert the Windows NT Emergency Repair Disk and choose the option to repair the boot files.
4. Restore your original MS-DOS and Windows 3.x configuration.

Troubleshooting Setup and System Startup

This section provides information about solving problems that might occur during Setup or system startup. For specific information about troubleshooting procedures and the tools provided with Windows 95 (including details about using the Startup menu and Safe Mode for troubleshooting), see [General Troubleshooting](#).

Note If you have MS-DOS-based applications that require complete access to system resources, see the information about using MS-DOS Mode in [Application Support](#).

Troubleshooting Specific Setup Errors

This section describes Setup problems and how to diagnose and correct them.

You can also get useful troubleshooting information from the SETUPLOG.TXT log file that Setup creates in the root directory of your startup drive, as described in [SETUPLOG.TXT: The Setup Log File](#).

If Setup fails, attempt to restart it by using the following procedure.



To restart Setup after a failure

1. Press F3 or click the Exit button.

If the system does not respond, restart the computer by pressing CTRL+ALT+DEL. If this fails, turn off the computer, wait 10 seconds, and then turn it on again.

2. Start Setup again. Setup prompts you to use Safe Recovery to recover the failed installation. Choose the Safe Recovery option and click the Continue button. Setup will skip the portion that caused the initial failure.
3. If the computer stops again during the hardware detection process, restart Setup again, and repeat the process until the hardware detection portion of Setup is completed.

You can use the information in SETUPLOG.TXT and DETLOG.TXT to check for the device or devices that caused the problems. Also review any messages added by Setup in the AUTOEXEC.BAT file for instructions on correcting setup problems.

The following sections describe specific setup problems and how to resolve them.

Setup fails to start.

If Setup fails to start, you should check memory, check for hardware detection conflicts, and check the access to the source for the Windows 95 installation files. Use the following checklist and procedures to find a solution.

- Check the computer for viruses.
- Check for sufficient conventional memory.
Windows 95 requires 420K. If this is not available, check for unnecessary drivers or TSRs, remove them and then try again. You can also run the MS-DOS MEMMAKER utility to optimize conventional memory.
- Check the RAM configuration in CONFIG.SYS.
For MS-DOS 4.x or earlier, settings should contain the following:

```
device=himem.sys
```

For MS-DOS 5 or later, settings should contain the following:

```
device=himem.sys  
device=emm386.exe noems  
dos=high,umb
```

Note The path to these drivers is not specified in the preceding example. If you don't specify the path, you need to copy the drivers to the root of the startup drive. Using **emm386** and **dos=high,umb** enables UMBs, but it is optional.

- Check for adequate XMS memory. Windows 95 requires at least 3 MB of XMS. If you are using MS-DOS 6.xx, press F4 when you start the computer and the Starting MS-DOS message appears. Choose Step-by-Step Confirmation to verify that HIMEM.SYS is loading. If not, make sure that verify the startup file syntax.
- At the command prompt, use **mem /c /p** to check for free conventional and XMS memory.
- If installing from a floppy disk or compact disc, check access to the drive.
- Remove all extra entries in CONFIG.SYS and AUTOEXEC.BAT, except those required to start the system and, for a networked computer, to start the network. It is especially helpful to remove any entries related to non-Microsoft disk caching software.

Setup starts but an error is reported during the installation process.

- Restart Windows 95 Setup and use Safe Recovery.
- Check the SETUPLOG.TXT or DETLOG.TXT files.
- Check the computer for viruses. This is an especially important step if Setup fails on disk 2 with floppy disk source files, or if it fails when the Windows 95 Startup wizard is preparing to run.
- Verify that all system and networking components function normally. Run virus detection software and **scandisk** (specifying a Thorough Type of Test) to identify system problems that might cause errors.
- Check the content of the error message. Windows 95 Setup errors contain additional information about the condition causing Setup to fail. Examine the device or condition that the error describes.
- Verify that system hardware is compatible. If Setup repeatedly fails, or if you suspect hardware conflicts with the Setup process, verify that the system components are supported. You might want to skip hardware detection.
- Check for a missing or damaged file. If a driver or system component file is referenced in the error, check to see if the file exists, if it is in the expected location, and if it has the correct file size, date, and version. For more information, see [General Troubleshooting](#).

Setup fails when run from floppy disks.

When Setup fails when it is being run from floppy disks, you might see a message asking you to insert a disk in the floppy drive when a disk is already in the drive. Or, you might use the **dir** command to examine a Setup floppy disk and find that it fails or that garbled characters appear on the screen.

To solve this problem, first disable any BIOS-enable virus checking routine. Then check your computer hardware documentation or check with the manufacturer to ensure that the computer's CMOS settings are correct. If changing settings as advised by the manufacturer does not solve the problem, you can use the DRIVPARM utility.



To use DRIVPARM to solve floppy-disk hardware problems

1. Start the computer using the most basic configuration files possible, loading no additional hardware drivers or other software in CONFIG.SYS and AUTOEXEC.BAT.
2. Insert a standard disk in drive A or drive B. At the command prompt, switch to that drive and type **dir**
3. If this works, insert a disk from the Windows 95 floppy disks in the same drive, and type **dir**
4. If this fails, garbled characters appear on the screen, or subsequent attempts to read the floppy disk fail, insert one of the following statements at the end of CONFIG.SYS.

For a 1.44-MB A drive, add:

```
drivparm=/d:0 /f:7
```

For a 1.44-MB B drive, add:

```
drivparm=/d:1 /f:7
```

5. If CONFIG.SYS contains an entry for DRIVER.SYS, disable it by adding **rem** before the related command line.
6. Save the CONFIG.SYS file, and restart the computer. Then repeat steps 2 and 3. If these steps are successful, leave the **drivparm** statement in CONFIG.SYS so that you can run Windows 95 Setup. If this procedure is not successful, the problem is related to the CMOS settings on the computer. For information and assistance, contact your computer manufacturer.

You cannot access the server when installing from the network.

- Verify that the network domain is validating the user account.
- Check the user name, password, and access rights.
- Check basic network functionality.
- Check conventional and XMS memory.
- Check for and remove unnecessary drivers and TSRs.
- If using a login script, check that the login script runs properly.

For more information, see [Introduction to Windows 95 Networking](#).

The network connection fails when you are installing from the network.

- Try to reconnect to the network share.
- If you cannot reconnect, restart the computer, and try again.
- Use another computer on the network to verify the installation server is working.
- Check the basic network connection.

Setup stops during hardware detection.

When Setup stalls during hardware detection, you might need to disable hardware detection for a device or class of devices. Before you do this, wait until at least three minutes have passed with neither disk nor screen activity (that is, the mouse pointer cannot be moved). Some detection routines take long enough that the computer might appear to stop temporarily.

**To skip hardware detection in order to avoid problems**

1. Run Windows 95 Setup from MS-DOS and, if this is not the first attempt to install, select Safe Recovery.
2. To disable the specific device detection during Setup, in the Hardware Detection dialog box, select the option to specify the hardware devices to detect. Then make sure the check box next to the device is not checked.

Setup cannot communicate with a device.

If Setup cannot communicate with a specific hardware device on the system during the installation of Windows 95, a message states that Setup has found a hardware device on your computer that is not responding and prompts you to try this device again. For persistent problems, the message provides instructions on how to exit Setup and restart the computer.

This error message can be caused by one of the following:

- The network has stopped responding
- A CD-ROM drive has stopped responding
- A floppy disk drive has stopped responding
- Setup can no longer access the hard drive to complete the installation process

Follow the recommendation in the message to turn off the computer, turn it back on, and then rerun Setup with Safe Recovery. If the problem persists, identify the problem from the preceding list and correct it.

Setup fails with error B1.

A B1 error message indicates that Setup has detected an older 80386 processor that is not supported and instructs you to upgrade your processor. Intel 80386 microprocessors dated before April 1987 are known as B1 stepping chips. These chips introduce random math errors when performing 32-bit operations, thus making them incompatible with Windows 95. If your 80386 chip was manufactured before April 1987 or has a label on it that reads "For 16-bit operations only," contact your hardware manufacturer about an upgrade.

Problems occur during the file-copying phase of Setup.

If this occurs, exit Setup, restart your computer, and then rerun Setup. When prompted, select the Safe Recovery option and click Continue. The installation process should complete successfully.

If your computer stalls after all files have been copied, or if you receive an error at this point, it might be due to virus-protection software. Some computers have virus protection built into the ROM BIOS. You should disable the virus protection software or run your computer's configuration program to disable virus checking and then restart Setup. Select the Safe Recovery option, and the installation process should complete successfully.

An "Incorrect MS-DOS version" error message appears.

When starting Setup from MS-DOS, you might receive an error stating that MS-DOS 3.1 or greater is required. MS-DOS versions earlier than 3.1 are not compatible with Windows 95.

This error can also occur when starting Setup from MS-DOS if you are using the 386MAX software utility. If this error occurs, temporarily disable the 386MAX commands from the startup files, and then run Setup again.

A “Standard Mode: Fault in MS-DOS Extender” error message appears.

When running Windows 95 Setup from MS-DOS you might receive this error, indicating there might be a conflict in the upper memory region. To resolve this, either disable UMBs or remove EMM386 statements from CONFIG.SYS and rerun Setup. Or run Setup from Windows 3.x.

A “Cannot open file *.INF” error message appears.

If you receive an error that states that an *.INF file cannot be opened, you might need to free memory by disabling SMARTDrive in AUTOEXEC.BAT, or by closing any applications running in Windows.

Setup requests a new source path.

If this occurs, check the file source (the floppy disk drive or the CD-ROM drive).

- In Windows File Manager, click the floppy disk drive, and verify that the drive and files are accessible by viewing directories and loading readable text files.
-Or -
At the MS-DOS command prompt, use the **dir** and **type** commands to verify that the drive and files are accessible by viewing directories and loading readable text files.
- If the floppy disk drive is inaccessible, try reading a different disk. If that doesn't work, shut down and restart the computer. Check CMOS settings for the floppy disk drive using the hardware manufacturer's diagnostic routine (consult your hardware documentation).
- If installing from a compact disc, verify that MSCDEX and the CD-ROM drivers are loaded and configured properly.

Setup is unable to find a valid boot partition.

A valid MS-DOS partition must exist in order for Setup to install Windows 95. If Windows 95 Setup is unable to find a valid boot partition during installation, it displays an error message. If you receive an error message, there might be an actual partition error, but it is more likely that disk compression software or network components are mapping over the boot drive. This might occur if you are mapping a network drive to E, but E is the hidden host drive for your disk compression software, or you are using LANtastic network and drive C is being mapped or shared.

To resolve the invalid partition error:

- Verify the drive is not mapped over (or logically remapped).
- Verify a valid, active partition using Fdisk. If no valid partition exists, take appropriate drive or data recovery efforts. If no active partition exists, use Fdisk to mark an appropriate partition as active.
- Remove interfering drivers from the startup configuration files, and run Setup again.
- If you are using disk compression software, ensure that none of your mapped network drive letters conflict with the host drive for disk compression.

Setup finds insufficient disk space.

If Setup does not find sufficient space to install Windows 95, check for space on the destination and boot drives, and if you are using compression, check actual free space.

Setup error occurs on a system with OS/2.

Setup disables OS/2 Boot Manager to ensure that Windows 95 can restart the computer and complete its installation. Therefore, if you are using OS/2 Boot Manager to choose operating systems at startup, OS/2 Boot Manager must be reset after Windows 95 is installed. Boot Manager can be reactivated by starting the computer with an OS/2 boot disk and by using the OS/2 Fdisk utility.

If you are not using Boot Manager, you should configure the computer to use Boot Manager, and then follow the preceding instructions. If you start MS-DOS from a floppy disk and run Setup, you will no longer be able to start OS/2 after Windows 95 has been installed. To avoid this, rename or delete the AUTOEXEC.BAT and CONFIG.SYS files that OS/2 uses before running Windows 95 Setup.

Setup fails automated installation from MSBATCH.INF.

If the automated installation fails, check the following:

- Verify the network connection if source files are on the network
- Check errors messages, if any
- Check the MSBATCH.INF file contents and syntax

- Check the network validation of user logon
- Check for enough memory
- Check for and remove unnecessary drivers and TSRs
- If using a login script, verify that the script ran properly

Troubleshooting Specific Startup Errors

This section describes specific conditions that might interfere with starting a Windows 95 computer and how to fix them.

In general, for system startup problems, the first problem-solving method is to start Windows 95 in Safe Mode. For information about how to start in Safe Mode and use BOOTLOG.TXT for troubleshooting, see [General Troubleshooting](#).

Windows 95 stalls during the first restart after installation.

Usually this occurs because of legacy hardware that was configured incorrectly before Windows 95 was installed. Remove settings for hardware services in CONFIG.SYS and AUTOEXEC.BAT. Also, ensure that any SCSI devices are terminated correctly. You might also need to disable the ISA enumerator. This software detects a new type of adapter that can be configured from the operating system. The detection sequence requires the ISA enumerator for I/O processes on some ports. Although every effort has been made to avoid ports commonly in use, you might have hardware that is also trying to use these I/O ports.



To disable the ISA enumerator

- Remove the following line from the [386Enh] section of SYSTEM.INI:

```
device = ISAPNP.386
```

Bad or missing file error occurs on startup.

If you receive a "Bad or missing *filename*" message when the system is starting (where *filename* might contain HIMEM.SYS, IFSHLP.SYS, and so on), do the following:

- Check the syntax of the entry in CONFIG.SYS or other startup file.
- Verify the existence, location, version, and integrity of the file.

If the filename to which the message refers is a device driver the computer needs for accessing the drive where Windows 95 is installed, you need to move the **device=** line that contains the device driver to the beginning of CONFIG.SYS to allow access to the drive when CONFIG.SYS tries to load files from the Windows directory.

Windows 95 has damaged or missing core files.

When Windows 95 loads, it counts on key files being available and undamaged. If a system file is damaged or missing, it might prevent loading or normal operation. If VMM32.VXD or other core files are missing or damaged, you might need to run Windows 95 Setup and select the Verify option in Safe Recovery to replace the files.

System Registry file is missing.

The Windows 95 Registry file is required for operation. This is contained in SYSTEM.DAT and USER.DAT, which are backed up as .DA0 files. If only the SYSTEM.DAT Registry file is missing, Windows 95 does one of the following:

- Windows 95 automatically replaces SYSTEM.DAT from the backup Registry .DA0 file.
-Or -
- Windows 95 automatically uses Safe Mode to start Windows 95 and displays the Registry Problem dialog box. Click the Restore From Backup And Restart button to restore the Registry, which copies SYSTEM.DA0 and USER.DA0 to .DAT files.

If both SYSTEM.DAT and SYSTEM.DA0 files are missing (or if the **WinDir=** entry in MSDOS.SYS is not set), a message informs you that the Registry file is missing and that Registry services are not available for this session. (This means that most operations in Windows 95 will fail.) After this message appears, Windows 95 automatically starts in Safe Mode and displays another message offering an option to restore the Registry. However, if there is no .DA0 file, the Registry cannot be restored. To resolve this problem, either restore SYSTEM.DAT from backup or run Windows 95 Setup.

For information about backing up and restoring the Registry, see [Windows 95 Registry](#).

BIOS or a BIOS setting is incompatible.

A ROM BIOS setting might prevent Windows 95 from installing or loading, because some computers have a feature that prevents applications from writing to the boot sector. This is usually in the form of anti-virus protection set through your computer's CMOS. If this is enabled, Windows 95 cannot complete the installation or cannot start properly.

If boot sector protection is enabled in the computer's BIOS, one of the following symptoms occurs:

- Windows 95 Setup stalls.
- Windows 95 stalls while starting.
- The anti-virus software prompts you to overwrite the boot sector. Choosing Yes might allow you to complete the Setup procedure, but Windows 95 stalls when it attempts to load.

To correct this problem, disable the Boot Sector protection feature through your computer's CMOS, then reinstall Windows 95. For information about disabling this feature, consult your hardware documentation or service center.

VxD error returns you to the command prompt.

If a VxD is missing or damaged, Windows 95 displays an error message that indicates which VxD is involved. If the VxD is critical to the operation of Windows 95, then Windows 95 does not start and the screen displays the command prompt. You might need to run Windows 95 Setup and select Verify or Safe Recovery to replace the missing VxD.

You can selectively override a VxD that is included within VMM32.VxD. If the same VxD is loaded twice, the second instance intercepts all the calls to that particular VxD. There are two ways to override this:

- Copy the related .VXD file into the Windows SYSTEM\VMM32 directory.
- Edit SYSTEM.INI to add the entry **device= filename.vxd** in the [386enh] section.

You cannot use dual boot to run a previous operating system.

To take advantage of the dual-boot support in Windows 95, you cannot install Windows 95 into an existing Windows 3.x directory, and the value **BootMulti=1** must be defined in the Windows 95 version of MSDOS.SYS.

DR DOS and versions of MS-DOS earlier than 5.0 do not support Windows 95 dual-boot functionality. To return to your previous operating system, you have to remove Windows 95 and reinstall your previous operating system, as described earlier in this chapter.

“Previous MS-DOS files not found” message appears.

When trying to dual-boot to the previous version of MS-DOS, you might receive an error message stating that your previous MS-DOS files were not found. It is probable that either the files are missing, or that your previous version of MS-DOS was not version 5.0 or higher.

You must have MS-DOS 5.0 or higher in order to start to a previous version of MS-DOS. Any version of MS-DOS earlier than 5.0 looks for the first three sectors of the IO.SYS file in the first three sectors of the data area of the drive. In MS-DOS 5.0 or higher, IO.SYS is designed to allow itself to be located outside the first three sectors of a drive's data area. In this situation, the only way to start to a version of MS-DOS prior to 5.0 is from a startup floppy disk.

Drivers, such as DBLSPACE.SYS, that are loaded when you start the computer using the earlier version of MS-DOS might not be available.

Required real-mode drivers are missing or damaged.

The previous operating system might have required certain real-mode drivers (compression, partitioning, hard disk drivers, and so on), and does not start correctly without them.

- At system startup, press F8 and select Step-By-Step Confirmation to verify the correct loading of all specified drivers.
- Verify that any drivers required to support your hardware are all specified in the appropriate startup file.

Windows 95 doesn't recognize a device.

In some cases, Windows 95 is unable to recognize an installed device, and the device resources are unavailable to Windows 95. If Windows 95 doesn't recognize an installed device, remove it in Device Manager, and reinstall it by using the Add New Hardware option in Control Panel. You can also use

Device Manager to check resource conflicts. For information, see [Devices](#). Or see the hardware conflict troubleshooting information in online Help.

Installing drivers causes Windows 95 system startup to fail.

If you try to install drivers for Windows 3.x from other vendors over Windows 95 (such as sound or video drivers), running the provided installation program can cause Windows 95 to fail to start or operate correctly.



To recover, when using a device that is supported by Windows 95

1. Remove all entries in SYSTEM.INI that were added by the installation software from another vendor.
2. Delete the device in Device Manager in the System properties, as described in [Devices](#).
3. Shut down and restart Windows 95.
4. Use the Add New Hardware option in Control Panel to reinstall the device by using the Windows 95 drivers.

The wrong applications run after Windows 95 starts.

- In Windows Explorer, double-click the Windows Start Menu\Programs\Startup directory, and then delete any items that you do not want to run when Windows 95 starts.
- If the programs that are running do not appear in the Start Menu folder in Windows Explorer, run Registry Editor and find this key:

```
HKey_Current_User\Software\Microsoft\Windows\CurrentVersion  
\Explorer\Shell Folders
```

The value of **Startup=** should be *Windows\Start Menu\Program\Startup*, where *Windows* is the drive and directory containing the Windows 95 files.

Converting Windows 3.x Program Groups

Windows 95 uses folders and links to provide the same functionality as groups and items in previous versions of Windows. As part of the upgrade from Windows to Windows 95, the GRPCONV.EXE utility provides the translation of groups and group items to folders and links.

GRPCONV runs automatically after Setup has copied most of the files needed for a complete installation and restarted the computer. It searches through all .GRP files listed in the PROGMAN.INI file, and then creates shortcuts for those entries in the Applications folder. GRPCONV also searches the SETUP.INI file and creates shortcuts in the Programs folder for all the items currently specified on the Windows Setup tab in Add/Remove Programs.

GRPCONV uses information from the Registry to track changes in group files that have occurred since the last time GRPCONV.EXE was run. There are no entries in either the SYSTEM.INI or WIN.INI file that take precedence over these Registry entries. The last modified date and time of the PROGMAN.INI file and all group files are stored in the following Registry key:

```
Hkey_Current_User\Software\Microsoft\Windows\CurrentVersion\GrpConv
```

You can also run GRPCONV manually to recreate default folders or to convert other Windows 3.x program groups. Notice that .GRP files are unique to earlier versions of Windows. If you install an application after Windows 95 is installed, no .GRP file is created in the PROGMAN.INI file. Therefore, running GRPCONV after Windows 95 is installed recreates only those groups that existed before you installed Windows 95.



To recreate the default folders provided with Windows 95

1. In the Windows directory, change the filename of SETUP.OLD to SETUP.INI.
2. From the Start button, click Run and then type **grpconv /s**

This command rebuilds the default Windows 95 folders. A status dialog box titled Start Menu Shortcuts appears during the rebuilding process. When it is complete, you are returned to the desktop.

You can manually convert one group at a time using GRPCONV.



To manually convert existing Windows groups to Windows 95 format

1. From the Start button, click Run and then type **grpconv /m**
2. Click the group you want to convert, then do one of the following:
 - Click Open, then click Yes in the Program Manager Group Converter dialog box, and complete entries in the Start Menu Shortcuts dialog box.
 - Or -
 - Convert the group by double-clicking the group name. For example, if you have a group called MYGROUP.GRP, you can double-click MYGROUP.GRP to convert it to the Windows 95 folder format.

The following presents some additional notes on GRPCONV:

- The first time GRPCONV runs, the search path criteria for finding existing groups is based on the contents of the PROGMAN.INI file in the current Windows directory (if it exists).
- All data in a .GRP file except icon location (x,y coordinates in a group) is used during conversion and migrated to folders in the Windows 95 Programs folder.
- GRPCONV migrates the [Restrictions] section of the PROGMAN.INI file from previous versions of Windows into the Policies key in the Registry.

Networking

This part of the *Windows 95 Resource Kit* contains the following chapters, describing how to run Windows 95 on Microsoft networks, Novell® NetWare®, and other networks.

Chapter 7 Introduction to Windows 95 Networking

Provides an overview of Windows 95 networking, including a discussion of compatibility and operational improvements introduced with Windows 95, streamlined steps for network configuration, and a summary of Plug and Play networking support.

Chapter 8 Windows 95 on Microsoft Networks

Presents procedures and technical information for using Windows 95 on Microsoft networks. Computers running Windows 95 can communicate with other computers running Windows 95, Windows for Workgroups, Windows NT, and LAN Manager on Microsoft networks.

Chapter 9 Windows 95 on NetWare Networks

Presents information for configuring and integrating Windows 95 on Novell NetWare networks.

Chapter 10 Windows 95 on Other Networks

Provides details about installing and running Windows 95 on other networks. This chapter also discusses mainframe connectivity for computers running Windows 95.

Chapter 11 Logon, Browsing, and Resource Sharing

Describes how to configure and use the Windows 95 logon process, browse network resources, and use the peer resource sharing capabilities.

Chapter 12 Network Technical Discussion

Describes technical issues related to network adapters and protocols for Windows 95, and also presents some technical notes and troubleshooting tips for networking.

Introduction

This chapter provides an overview of Windows 95 networking, including a discussion of compatibility and operational improvements introduced with Windows 95, streamlined steps for network configuration, and a summary of Plug and Play networking support.

- Windows 95 Networking: The Basics
- Windows 95 Networking: The Issues
- Network Configuration Overview
 - Installing Networking Components
 - Setting Computer Name and Workgroup
 - Starting the Network During System Startup
- Plug and Play Networking Overview
- Basic Troubleshooting for Networking

Windows 95 Networking: The Basics

The Windows 95 operating system includes built-in networking support with a wide range of improvements over earlier versions of Windows. This includes built-in support for popular networks, plus an open, extensible networking architecture.

For supported networks other than Microsoft networking, the computer must already have the networking software from another vendor installed. Windows 95 Setup adds only the client or protocols required to work with Windows 95. The following networks are supported:

- Artisoft® LANtastic® version 5.0 and greater
- Banyan® VINES® version 5.52 and greater
- DEC™ PATHWORKS™ (installed as a protocol)
- Microsoft networking — Microsoft LAN Manager, Windows for Workgroups 3.x, and Windows NT
- Novell® NetWare® version 3.11 and greater
- SunSoft™ PC-NFS® version 5.0 and greater

The built-in networking components include support for a wide range of network transports (such as TCP/IP and IPX/SPX), industry-wide communications protocols (such as RPC, NetBIOS, and named pipes), and existing network device standards (such as NDIS and ODI). Because of the extensible architecture, other network vendors can add network connectivity enhancements and application support, and you can mix and match components at every layer. For information, see [Windows 95 Network Architecture](#).

The following list summarizes the benefits of networking features in Windows 95.

Robust networking components using no conventional memory.

The protected-mode clients provided with Windows 95 — Microsoft Client for NetWare Networks and Client for Microsoft Networks — use only 32-bit, protected-mode protocols, drivers, and supporting files. On large block transfers over the network, these protected-mode clients are up to twice as fast as real-mode clients under Windows 3.x. Windows 95 includes new 32-bit drivers for network protocols and adapters, plus a new implementation of TCP/IP.

Easy, graphical configuration for all networking components.

All network clients, adapter drivers, protocols, and services are installed and configured by using the Network option in Control Panel rather than by editing configuration files manually. All configuration values for protected-mode components are stored in the Registry.

Automatic setup of Windows 95 on network workstations.

For both Windows-based and MS-DOS-based computers, Setup upgrades the network software whenever possible to a Windows 95 protected-mode client and supporting protected-mode components, based on information detected about existing networking components. Setup also supports automated installation and customization during installation from setup scripts, plus installing Windows 95 to run from a local hard disk or from a shared network copy. For information, see [Server-Based Setup for Windows 95](#), and [Custom, Automated, and Push Installations](#).

Peer resource sharing with protected-mode network clients.

Any computer running the protected-mode Microsoft Client for NetWare Networks or Client for Microsoft Networks can be set up to serve as a file and print server for other computers on the network. Resources can be protected with user-level security on NetWare or Windows NT networks using existing user account databases. On Microsoft networks, resources can also be protected with share-level security.

Simultaneous connection to multiple networks on a computer.

The number of network connections allowed on a computer running Windows 95 depends only on the limits of your networking software. (Windows 3.x supported connection to only one network. Windows for Workgroups 3.11 allowed simultaneous connection to only two networks.) For information, see [Windows 95 Network Architecture](#).

Plug and Play networking support.

You can insert or remove a PCMCIA network adapter while the computer is running, and Windows 95

assigns the required resources automatically and makes or removes the network connection. For any network adapter that uses an NDIS 3.1 driver, you can remove a docking unit without turning off the computer. If you disconnect the network cable from a computer running Windows 95 with Plug and Play components, the system continues to function. With most real-mode network clients, this causes the system to stall. For more information, see [Plug and Play Networking Overview](#).

Unified logon, logon script processing, and resource browsing.

You can use the Windows 95 unified user logon and password caching to log on to Windows NT, Novell NetWare, and other networks. Automatic logon script processing is provided for Microsoft and NetWare networks. Users can access network resources by using Network Neighborhood or common dialog boxes, such as the Open or Save As dialog boxes. For more information, see [Logon, Browsing, and Resource Sharing](#).

Automatic reconnection for lost server connections.

When servers are available again after the loss of a network connection, Windows 95 reconnects automatically and rebuilds the user's environment, including connection status, drive mappings, and printer connections.

Client-side caching of network data with protected-mode clients.

A protected-mode network client is a file system driver that uses the same 32-bit cache (VCACHE) used by all Windows 95 file system drivers, so it can cache network data for quick access. Files read across the network are copied to the RAM cache and made available to applications much faster than they would by rereading the file across the network. For a given file request, the cache is checked for the needed data before checking the network. This feature is available when running Client for NetWare Networks or Client for Microsoft Networks. For more information, see [Disks and File Systems](#).

Long filenames for network resources.

Computers running Windows 95 can recognize and use long filenames on other computers running Windows 95, on Windows NT servers, and on NetWare 3.x and 4.x volumes that have been configured to use the OS/2® name space. For more information, see [Disks and File Systems](#).

Support for the Win32 WinNet interface.

This is an API that allows developers to create applications that run unmodified on different networks. The Win32 WinNet interface in Windows 95 supports 16-bit and 32-bit applications (as opposed to the WinNet interface in Windows 3.x, which supports only 16-bit applications). For information, see [Windows 95 Network Architecture](#).

User profiles and system policies for automatic configuration.

To take advantage of system policies, the computer must be running a protected-mode network client such as Microsoft Client for NetWare Networks or Client for Microsoft Networks. For information, see [User Profiles and System Policies](#).

Agents for network backup and remote management.

Windows 95 includes backup agents for Cheyenne® ARCserve and Arcada® Backup Exec. Agents for Simple Network Management Protocols (SNMP) and Microsoft Network Monitor are available in the ADMINNETTOOLS directory of the Windows 95 compact disc. When the correct system management agent is installed on client computers, you can use a service such as HP® Open View or Microsoft Systems Management Server to manage workstations remotely. For information about remote administration, see [Remote Administration](#).

Dial-up networking for remote access.

Windows 95 supports multiple protocols for remote access, including TCP/IP, IPX/SPX and the industry standard, Point-to-Point Protocol (PPP). For information about remote access protocols and connection types, see [Dial-Up Networking and Mobile Computing](#).

Windows 95 Networking: The Issues

If the real-mode network is running when you start Windows 95 Setup, the appropriate network client is installed automatically. This is the recommended method for installing networking support in all cases. When Setup detects existing network components, it installs the appropriate supporting software automatically and moves the configuration settings to the Registry, wherever possible.

If Windows 95 Setup detects that NetWare networking components are present, it installs the new protected-mode client, Microsoft Client for NetWare Networks, plus the supporting protected-mode protocol and adapter drivers. Client for NetWare Networks is not installed automatically, however, if Setup detects VLM running with NDS support. To maintain the existing real-mode client and support configuration, you must run Setup in Custom mode and manually select the NetWare client. For more information, see [Windows 95 on NetWare Networks](#).

Microsoft recommends using the 32-bit, protected-mode networking components wherever possible. With protected-mode networking components, all configuration settings are stored in the Registry, so you do not have to maintain configuration files such as AUTOEXEC.BAT, PROTOCOL.INI, or NET.CFG. The protected-mode networking components also allow you to take advantage of the many related benefits such as:

- Performance and reliability
- Peer resource sharing capabilities
- Use of system policies for administrative control, remote administration of the Registry, and use of the network agents, such as Network Monitor and Remote Registry service, available in the ADMIN\NETTOOLS directory on the Windows 95 compact disc

If you must run a real-mode client, networking settings are required in AUTOEXEC.BAT, plus a NETSTART.BAT file might be required to start the network during system startup. Configuration settings are maintained in PROTOCOL.INI or a similar file, depending on the particular network.

Network Configuration Overview

You can install and configure all networking options for Windows 95 automatically or manually during Windows 95 Setup. You can also install and configure networking support after installing Windows 95 by using the Network option in Control Panel. In the Network option, you can set properties for the following:

- Configuration of network clients, adapters, protocols, and services
- Identification of the computer on the network
- Access control, to specify the security used when other users access this computer over the network

In the procedures presented in the following sections, it is assumed that Windows 95 and the appropriate networking hardware have already been installed on your computer. You might also need to install or configure various supporting components, such as security, mobile networking components, agents for backup and remote administration software, and support for user profiles and system policies.

Tip To quickly display the Network option in Control Panel, right-click the Network Neighborhood icon on the desktop, and then click Properties on the context menu.

Installing Networking Components

The recommended method for installing networking components for Windows 95 is to ensure that the existing real-mode networking components are running when you start Windows 95 Setup. In this case, Setup detects the existing components and installs corresponding support for Windows 95 automatically and, wherever possible, migrates configuration settings to the Registry. For more information about how to do this, see [Introduction to Windows 95 Setup](#).

This section summarizes how to install networking support by using the Network option in Control Panel after Windows 95 is installed. Specific issues for installing various network components are discussed in the other chapters in this part of *Windows 95 Resource Kit*. The following procedures describe the general steps that are required for installing networking components.



To install a driver for a new network adapter after Windows 95 is installed

- Run the Add New Hardware option in Control Panel, and be sure to answer Yes when asked whether Windows 95 should search for new hardware.



To install networking components after Windows 95 is installed

1. In the Network option in Control Panel, click the Configuration tab, and then click Add.

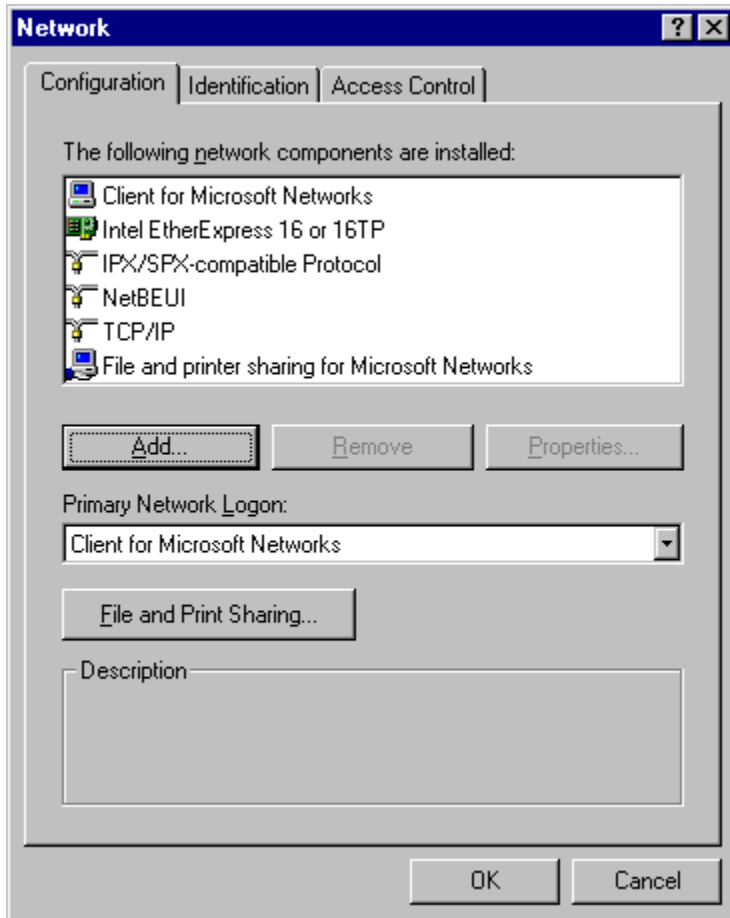

2. In the Select Network Component Type dialog box, double-click the type of component to install, as described in the following list.

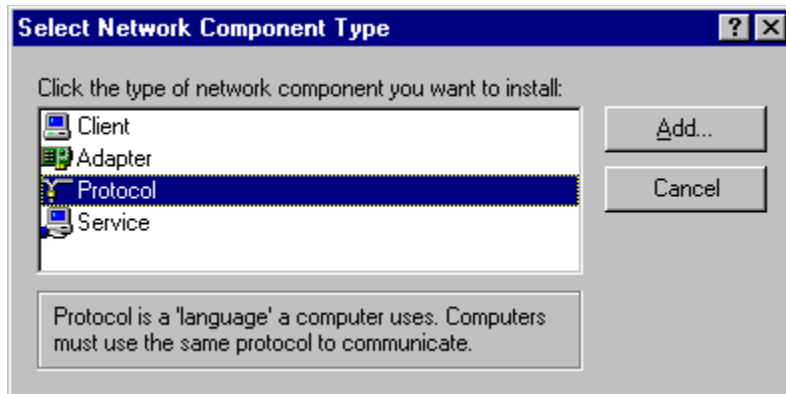

Component Description

Client	Installs client software for the types of networks the computer is connected to. You can use either a 32-bit network client (which needs no real-mode components) or older real-mode networking clients. There is no limit to the number of 32-bit network clients you can install, but you can have only one real-mode network client installed at a time. Some networks are supported only as primary networks. For information, see Windows 95 on Other Networks .
Adapter	Installs drivers for the network adapters in the computer. However, the recommended method for installing a new adapter is to use the Add New Hardware option in Control Panel. You can configure the type of driver to use (such as enhanced-mode NDIS, real-mode NDIS, or ODI), specify the resources for the adapters you are using (such as I/O, IRQ, and transceiver type), and define other options for the adapter. For information, see Network Technical Discussion .
Protocol	Installs network protocols and sets related options. For information, see Network Technical Discussion .
Service	Installs peer file and printer sharing services and other types of network services, such as backup agents, additional print services, Microsoft Remote Registry, and Network Monitor. For information, see Remote Administration .

3. In the Select dialog box, select the name of the component manufacturer in the Manufacturers list, and then select the specific component in the Models list. Then click OK.

Note Some components require that you shut down and restart the computer after installing them.

You can also install and configure networking components by using custom setup scripts or system policies. For information, see [Custom, Automated, and Push Installations](#), and [User Profiles and System Policies](#).

Setting Computer Name and Workgroup

Windows 95 requires that you define a workgroup and computer name for each networked computer, independent of the type of networking software you use. This information is required if you install networking software during Windows 95 Setup. You can also change the computer name or workgroup after Setup is complete.



To specify the computer name, workgroup, and description for a computer

1. In the Network option in Control Panel, click the Identification tab.

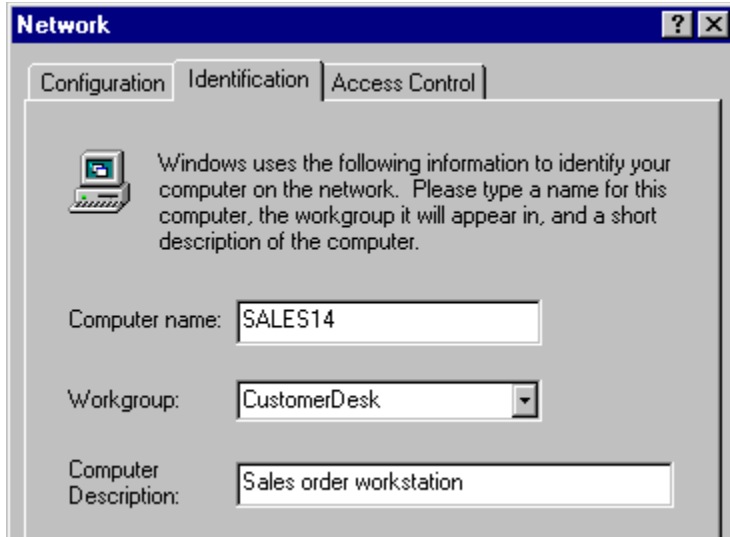

2. Type the values for the computer identification settings as described in the following list.

Setting	Description
Computer Name	The computer name must be unique on the network. It can be up to 15 characters long, with no blank spaces. The computer name can contain only alphanumeric characters, plus the following special characters: ! @ # \$ % ^ & () - _ ' { } . ~
Workgroup	The workgroup name does not need to be unique, but it uses the same naming conventions as the computer name. For information about using WRKGRP.INI to set administrative guidelines for specifying the workgroup that can be selected, see Custom, Automated, and Push Installations .
Computer Description	This information is displayed as a comment next to the computer name when users are browsing the network.

Starting the Network During System Startup

If your computer uses 32-bit, protected-mode networking components exclusively, you do not need statements in AUTOEXEC.BAT or other startup batch files to start the network when you start the computer. The installation of the correct protected-mode network client, protocol, and network adapter

driver, as shown in the Network option in Control Panel, is all you need to ensure that networking is available whenever you start Windows 95.

If your computer uses any real-mode components for the client, protocol, or network adapter driver, then you must include commands to start the network in AUTOEXEC.BAT or a batch file that is called from AUTOEXEC.BAT. This is because real-mode components must be inserted properly in the startup sequence to be available to other parts of the system.

For real-mode components on NetWare networks, the NET.CFG or similar file is used to start and configure networking during system startup. The user or network administrator must maintain this file. For Microsoft networks, the **net start** statement in AUTOEXEC.BAT is used to start any real-mode networking components. If this statement is required for any components, the operating system automatically places the **net start** statement at the beginning of AUTOEXEC.BAT. If you (or another user) removes this statement, the system replaces it so that the real-mode networking component is available the next time the computer is started.

The PROTOCOL.INI file stores settings for real-mode networking components. The only sections that might be read are [PROTMAN\$], [*netcard*], and [NDISHLP\$]. For information about the content of PROTOCOL.INI, see [Windows 95 on Microsoft Networks](#).

Plug and Play Networking Overview

The networking components in Windows 95 are designed for dynamic Plug and Play operation with most ISA, EISA, PCI, IBM Micro Channel®, and PCMCIA network adapters. To take advantage of these features, the computer must be running all protected-mode networking components, including client, protocols, and network adapter drivers.

NDIS 3.1 supports adding and removing Plug and Play network adapters dynamically while the computer is running. If an event occurs such as undocking a portable computer, the Windows 95 protocols can remove themselves from memory automatically. However, the Windows 95 protocols must load information during system startup to be available. So when an event occurs such as the dynamic addition of a PCI network adapter, the operating system prompts you to restart the computer. If you are certain that the required protocol is already loaded, you can ignore this message.

Additional Plug and Play networking benefits are available when you use 32-bit sockets with PCMCIA cards. You can click the PCMCIA icon on the taskbar to remove the card without shutting down Windows 95 or turning off the computer. Using the PCMCIA icon causes the operating system to perform an orderly shutdown. Windows 95 notifies applications that the network is no longer available and automatically unloads any related drivers or protocols.

To help mobile users who might need to change adapters in their hardware, Windows 95 uses 32-bit Card and Socket Services to support hot removal and insertion of PCMCIA cards, including network adapters. Support for hot docking means that users do not have to restart their computers each time they make a change to the configuration. For information about using and configuring PCMCIA cards, including how to enable 32-bit Card and Socket Services, see [Devices](#).

Network Plug and Play support in Windows 95 includes application-level support. An application created for Windows 95 might be designed with the ability to determine whether the network is available. Therefore, if a network adapter is removed, for example, the application automatically puts itself into "offline" mode to allow the user to continue to work, or it shuts down.

Basic Troubleshooting for Networking

This section provides basic troubleshooting information for installing network components with Windows 95. For additional information about troubleshooting for particular networks, see the chapters in [Networking](#). For information about general troubleshooting procedures and the supporting tools provided with Windows 95, see [General Troubleshooting](#); for information about troubleshooting network problems, see online Help.

When troubleshooting network problems, start by verifying the network operations status prior to and during the error condition. To evaluate the network problem, check these factors:

- Did the network work before? If so, what has changed? If any hardware or software has been added or removed, reset the original network hardware or software, and try again.
- If the network was provided by another vendor, was it installed previously and working? If not, reinstall the other vendor's network. Verify that the network operates correctly. Reinstall Windows 95.
- Has any network cable been moved or added? Check cables, connections, and terminators.
- Have any protocols been added or removed? Check protocol settings, protocol bindings, and the compatibility of the protocol with the network.
- Are the network adapter settings correct? Check network adapter settings. Consult the documentation for the correct settings. Reset the adapter settings to the correct values if necessary. Restart the computer and try again.
- Has any network adapter been moved or added? Check the adapter connection, and check any other working adapter.
- Are the network connections live? Look at the status lights on the back of the network adapter or on the media attachment unit. If the status lights show activity, the connection is live. If the status lights show no activity, disconnect and reconnect the network cable and check for activity. If the lights on the adapter are off, try a different network outlet.

Check domain or server validation.

Verify that the network domain or server is validating the user account. If the logon isn't validated, connections to required servers cannot be made, login scripts won't run, and so on. If the network domain or server doesn't validate the account, perform each of the following procedures.



To check the logon setting

1. In the Network option in Control Panel, double-click the network client (for example, Client for NetWare Networks or Client for Microsoft Networks).
2. In General properties, do the following:
 - For Client for Microsoft Networks, verify that logon validation is enabled and that the correct domain name or preferred server is shown.
 - For Client for NetWare Networks, verify that the correct server is specified as the Preferred Server.



To check the user and workgroup names

- In the Network option in Control Panel, click the Identification tab. Check the computer name and workgroup name.

Also check basic logon requirements. For example, verify that the user password and the domain or preferred server account are correct, and test basic network functionality, such as viewing or connecting to other servers.

Check connections to network resources.

Determine whether domains, workgroups, and workstations appear in Network Neighborhood. If they appear, try connecting to a server or workstation. If they do not appear, then verify that at least one server exists on the local network and that client services and protocols are installed. Also, check cable termination.

If you cannot connect to the server or workstation you want, review the error messages. At the

command prompt, use the **net use** command (as described in [Logon, Browsing, and Resource Sharing](#)) to verify that you can connect to at least one server and workstation. If you cannot connect to any server or workstation, then check workgroup assignment, domain assignment, domain logon, and basic network operations.

If you still cannot connect, determine whether you can connect to a server from another computer. If this doesn't work, it probably indicates a problem with the server you are trying to connect to, or with the cabling or routing to that server.

Verify that the File and Printer Sharing service appears in the list of installed network components to ensure that peer resource sharing is enabled. Also verify that the correct settings for the browsing method are configured in the properties for the File and Printer Sharing service. For information, see [Logon, Browsing, and Resource Sharing](#).

Check network adapter and protocol configuration.

The following procedure summarizes how to check settings for network adapters. For more information about configuring network adapters, or for detailed troubleshooting steps for protocols, see [Network Technical Discussion](#).

Note If the network adapter is not terminated, Windows 95 stalls during system startup (similar to Windows for Workgroups 3.11). To test whether this is causing a computer to stall, try terminating the network adapter directly.



To check network adapter settings

1. In the Network option in Control Panel, double-click the entry for the network adapter in the list of installed components.
2. Click the Advanced tab, and verify that each entry in the Property area has an appropriate value specified in the Value area. For information, see your hardware documentation.
3. Click the Resources tab, and then verify that the configuration type, I/O address range, and IRQ are correct. Again, for information, see your hardware documentation.
4. Click the Driver Type tab, and then verify that the appropriate driver type is selected. (If you are using a protected-mode network client, the default is an Enhanced Mode NDIS Driver.)
5. Click the Bindings tab, and verify that each protocol is checked. If a protocol is not checked, that protocol is not providing network functionality using that adapter.

Check real-mode network components.

To check basic network communications, you can use the **net diag** command with a second computer connected to the same local network. As a diagnostic tool, **net diag** can assist you in troubleshooting network connectivity problems by establishing a diagnostic server and then verifying that the local computer can connect to this server.



To establish a diagnostic server on a second local computer

1. At the command prompt, type:
net diag
2. When a message appears showing you the protocols in use, press one of the numbers indicated in the message to specify the protocol to test.
3. When a message appears prompting you to specify whether a diagnostic server exists, press N.



To verify that the diagnostic server is detected in a Windows 95 VM

1. On the computer that is not the diagnostic server, at the command prompt, type:
net diag
A message appears showing the protocols in use.
2. To specify the protocol to test, type one of the numbers in the message for the protocol used on the diagnostic server.
A message appears stating that the diagnostic server has been detected.



To reinstall the protected-mode drivers in Windows 95

1. In the Network option in Control Panel, make note of each installed component.
2. For each component, click the component, and then click the Remove button.
3. Install the components by following the procedure named "To install networking components after Windows 95 is installed" in [Installing Networking Components](#).

Introduction

Computers running Windows 95 can communicate and share resources with other computers running Windows 95, Windows for Workgroups, Windows NT Server and Windows NT Workstation, and LAN Manager on Microsoft networks. This chapter presents procedures and technical information about using Windows 95 on Microsoft networks.

Important Each computer running Windows 95 must have a client access license if it will access Windows NT Server 3.5 servers on a network. For more information, see [Client Access Licenses for Windows NT Server](#).

- [Windows 95 and Microsoft Networking: The Basics](#)
- [Windows 95 and Microsoft Networking: The Issues](#)
 - [Issues for Server-Based Microsoft Networks](#)
 - [Issues for Peer-to-Peer Networks](#)
- [Installing Client for Microsoft Networks](#)
- [Configuring Client for Microsoft Networks](#)
 - [Configuring the Primary Client for Network Logon](#)
 - [Configuring Logon and Reconnection Options](#)
- [Running Windows 95 in a Mixed Microsoft Environment](#)
 - [Running Windows 95 with Windows NT](#)
 - [Running Windows 95 with LAN Manager](#)
 - [Running Windows 95 with Windows for Workgroups](#)
 - [Running Windows 95 with Workgroup Add-on for MS-DOS](#)
- [PROTOCOL.INI: Real-Mode Network Initialization File](#)

Windows 95 and Microsoft Networking: The Basics

Client for Microsoft Networks is the 32-bit, protected-mode network client for Windows 95 that provides the redirector and other software components for Microsoft networking. Client for Microsoft Networks also supports limited interoperability with other Microsoft-compatible server message block-based (SMB) servers such as IBM® LAN Server, DEC™ PATHWORKS™, AT&T® StarLAN, and LAN Manager for UNIX® Systems local area network software.

You can install Client for Microsoft Networks to serve as the sole network support for Windows 95 or to coexist with Client for NetWare Networks or clients from other network vendors, as described in [Windows 95 on Other Networks](#). For technical information about these optional configurations, see [Windows 95 Network Architecture](#).

Support for computers running Client for Microsoft Networks includes all the robust networking features built into Windows 95:

- Automatic setup, user profiles, and system policies for configuring computers
- Dial-Up Networking, share-level and pass-through user-level security, and remote administration capabilities
- Unified logon and automatic reconnection to network resources

The following list summarizes the additional key benefits of using Client for Microsoft Networks.

A high-performance system using no conventional memory.

Client for Microsoft Networks uses only 32-bit, protected-mode supporting networking components and, as a file system driver, uses Windows 95 caching (VCACHE). Client for Microsoft Networks uses 32-bit versions of NetBEUI, Microsoft TCP/IP, and the Microsoft IPX/SPX-compatible protocol and NDIS 3.1-compliant network adapter drivers. This protected-mode client is designed to be used in a multitasking environment, providing robust performance and using no MS-DOS conventional memory space. For information about supporting protocols and network adapter drivers, see [Network Technical Discussion](#).

Protected-mode peer resource sharing services.

You can configure computers running Client for Microsoft Networks to provide peer server capabilities using File and Printer Sharing for Microsoft Networks. For information, see [Logon, Browsing, and Resource Sharing](#).

Security and other support on Windows NT networks.

You can use Windows NT servers to validate user logon and to provide pass-through security for shared resources on computers running Windows 95. Computers running Windows 95 can recognize and use long filenames on Windows NT servers because the two operating systems use the same algorithm for long filenames and aliases. For information, see [Security](#) and see also [Running Windows 95 with Windows NT](#).

In addition, a computer running Windows 95 can start from a floppy disk or local hard disk and run a shared copy of Windows 95 stored on a Windows NT server. Support for booting diskless workstations will be available in Windows NT Server update releases. For information about shared installations, see [Server-Based Setup for Windows 95](#). For information about installing Windows 95 from login scripts using Windows NT Server, see [Custom, Automated, and Push Installations](#).

Windows 95 on Microsoft Networks

Windows 95 and Microsoft Networking: The Issues

This section summarizes some issues you should consider when using Windows 95 with Client for Microsoft Networks, whether your site uses server-based or peer-to-peer networking.

Windows 95 on Microsoft Networks

Windows 95 and Microsoft Networking: The Issues

Issues for Server-Based Microsoft Networks

On server-based networks, central servers running Windows NT Server or Microsoft LAN Manager 2.x act as file and print servers and provide support for managing network logon and security. For information about the benefits of server-based networks using Windows NT Server, see [Running Windows 95 with Windows NT](#).

- You must configure Client for Microsoft Networks as the Primary Network Logon client if you want to take advantage of user profiles for configuring or managing custom desktops on a Microsoft network, or if you want users to use system policies stored on a Windows NT server.
- To share resources with computers running other Microsoft networking products, the computers must be running a common protocol.
- Client for Microsoft Networks can use a LAN Manager domain controller for logon validation. However, File and Printer Sharing Services for Microsoft Networks cannot use a LAN Manager domain controller for pass-through validation. To take advantage of the user-level security support on Microsoft networks, the user must have an account on a Windows NT domain.

Windows 95 on Microsoft Networks

Windows 95 and Microsoft Networking: The Issues

Issues for Peer-to-Peer Networks

In the peer-to-peer networking model, at least one computer must — but each computer can — act as both a client and a server. As a client in a peer network, the computer can access the network resources shared on another computer. A peer network can be an appropriate networking solution for small offices with only five to ten users.

Any computer running Windows 95 can act as both a client and a server on peer networks. If you have the technical expertise, you can establish the wiring for a small peer network using Windows 95 yourself; otherwise, use the services of a system integrator. The following sections summarize issues either you or the system integrator need to consider for peer networking with Windows 95. For technical information about configuring and using File and Printer Sharing for Microsoft Networks, see [Logon, Browsing, and Resource Sharing](#).

Windows 95 on Microsoft Networks

Windows 95 and Microsoft Networking: The Issues

Issues for Peer-to-Peer Networks

Choosing Thinnet or Twisted Pair for Cabling

Thinnet (also called thin-Ethernet or Thin Coax) is the simplest method of cabling 10 or fewer connections on a network. Thinnet cabling uses coaxial cable with a BNC connector at each end. The cable attaches to each computer with a BNC T-connector. The major disadvantage in using thinnet cabling is that if there is a fault in the cabling at any computer, it affects all computers on the network. Thinnet cabling is only appropriate for Ethernet topologies.

Unshielded Twisted Pair cabling (called VTP or twisted pair) cabling is based on common telephone wiring technology, using connectors similar to those inserted in telephone jacks. Twisted-pair cabling is appropriate if your network has or will have more than 10 computers, and if computers are located in low-noise environments such as an office — it's not appropriate for manufacturing or warehousing environments. You can use twisted-pair cabling for Ethernet or token-ring networks.

When cabling the network, make sure not to use twisted-pair wiring that was previously used for telephone systems or that is more than five years old. To make the network active, you need additional components such as hubs and concentrators. These components help to isolate cabling failures.

Choosing the Peer Network Components

This section summarizes issues for networking components and organization.

Choosing protocols and other networking components.

Microsoft NetBEUI is a fast protocol, requiring no additional configuration settings; it is a good choice for peer-to-peer networks. The IPX/SPX-compatible protocol is another alternative for small peer-to-peer networks. You also need an NDIS 3.1 network adapter driver. For information about these components, see [Network Technical Discussion](#).

Setting up security and automated backup.

Share-level security is the only security option available on peer-to-peer networks. With share-level security, you create passwords to control access to shared resources on a peer server. For information about managing passwords for Windows 95, see [Security](#). If you need to control access to files or to particular computers based on user identity, create a server-based network.

You can use any backup software that is compatible with Windows 95 to back up files on peer servers and other computers. To make sure data on the network is backed up automatically, use a server-based network.

Setting up peer servers.

Each computer that is running File and Printer Sharing for Microsoft Networks can act as a server, so that other computers can connect to it to use files or printers created on that peer server. Because work on a peer server can slow down if many users are using services on the peer server, you might want to dedicate one computer as a print server. In this configuration, users can return to work immediately after printing, and the dedicated computer can manage the print queue.

For optimal performance on each computer that is extensively used as a file or print server, use the System option in Control Panel to optimize the performance of the file system for supporting network server activities. For information, see [Performance Tuning](#).

Managing a peer network.

Most of the remote administration features in Windows 95 rely on user-level security, which requires a server running Windows NT or NetWare to provide pass-through authentication of users for access to resources on remote computers. Therefore, on peer-to-peer networks, you cannot use Microsoft Remote Registry services, or any administrative features that require remote access to the Registry. However, you can use Net Watcher to manage the file system on remote computers, as described in [Remote Administration](#).

If you want to take advantage of remote administrative features or user-level security, consider a small server-based network using Windows NT.

Installing Client for Microsoft Networks

In Windows 95, Client for Microsoft Networks provides the redirector (VREDIR.VXD) to support all Microsoft networking products that use the SMB protocol. This includes support for connecting computers running Windows 95, LAN Manager, Windows NT, Windows for Workgroups, and Workgroup Add-on for MS-DOS networking software for personal computers running MS-DOS.

Because Windows 95 network redirectors are implemented as file system drivers, Client for Microsoft Networks provides mechanisms for locating, opening, reading, writing, and deleting files, submitting print jobs, and making available application services (such as named pipes and mailslots).

If a previous Microsoft network client is running when Windows 95 Setup is started, then Client for Microsoft Networks is installed automatically. You can also add Client for Microsoft Networks after you add network hardware to the computer.



To install Client for Microsoft Networks

1. In the Network option in Control Panel, click the Add button.
2. In the Select Network Component Type dialog box, double-click Client.
3. In the Select Network Client dialog box, click Microsoft in the Manufacturers list, and then click Client for Microsoft Networks in the Network Clients list. Click OK.

Configuring Client for Microsoft Networks

To configure Client for Microsoft Networks, you need to consider the following:

- Will Client for Microsoft Networks be the Primary Network Logon client?
- Will users log on to a Windows NT domain for logon a single Windows NT computer, or a LAN Manager domain validation?
- Will persistent connections to network drives be restored when the user logs on to Windows 95 or only when the resource is used?

This section describes these options and how to configure the network client.

Windows 95 on Microsoft Networks

Configuring Client for Microsoft Networks

Configuring the Primary Client for Network Logon

If you set Client for Microsoft Networks as the Primary Network Logon, the Microsoft network is used to download system policies and user profiles, and the first logon prompt that appears will be for the Windows NT network. Also, if more than one network client is installed, the last login script will be run from Windows NT (or LAN Manager, depending on your network).



To make Client for Microsoft Networks the Primary Network Logon client

1. In the Network option in Control Panel, click the Configuration tab.
2. In the Primary Network Logon list, click Client for Microsoft Networks.

Configuring Logon and Reconnection Options

In the Network option in Control Panel, you can specify network validation and resource connection options. If you enable logon validation, Windows 95 automatically attempts to validate the user by checking the specified domain. You must enable this option if you want to access user profiles and system policies on a Windows NT domain. If logon validation is required on your network and this option is not configured, you might not be able to access most network resources. If this option is configured and you (or another user) do not provide a correct password, you might not have access to network resources.

Note The user's user name and password must be specified in a user account on the specified Windows NT domain, LAN Manager domain, or Windows NT computer for logon validation to work.

You can also set logon validation by using system policies. With system policies, you can prevent the user from accessing resources on the local computer if the correct logon password is not provided. For more information, see [User Profiles and System Policies](#).

Note Windows 95 does not support using a LAN Manager domain controller as a pass-through security provider, but LAN Manager can provide logon validation.



To enable logon validation for Client for Microsoft Networks

1. In the Network option in Control Panel, double-click Client for Microsoft Networks in the list of network components.
2. In General properties, check the Log On To Windows NT Domain option if you want to log on to a Windows NT or LAN Manager domain automatically when starting Windows 95.
If you do not want to log on to a domain when starting Windows 95, make sure this option is cleared.
3. If you select logon validation, you must also specify the domain to be used for validation by typing or selecting a name in the Windows NT Domain box.
You can specify a Windows NT or LAN Manager domain name or the name of a Windows NT computer (version 3.1 or 3.5) where you have a user account.

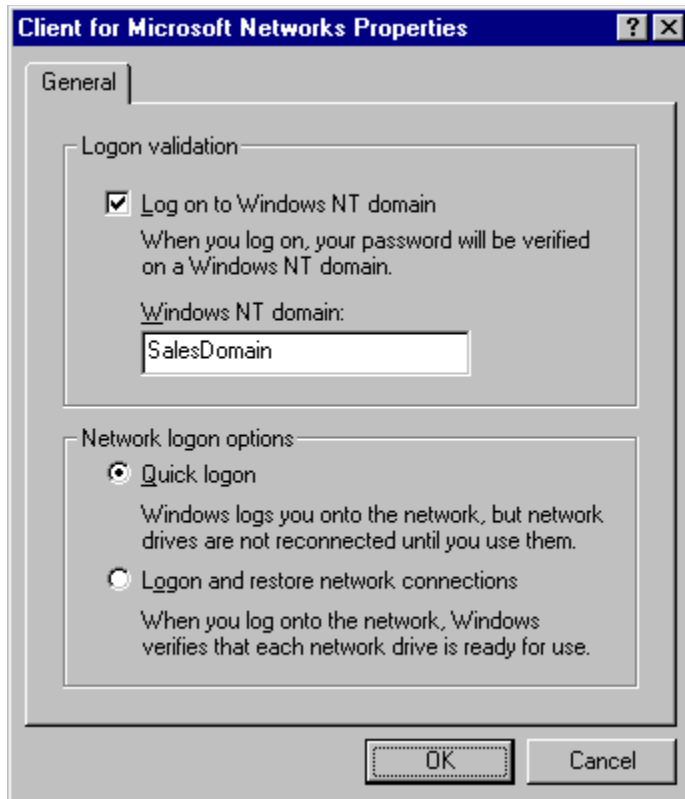

You can also specify whether Windows 95 should use “ghosted connections” or reestablish and verify each persistent connection at system startup.



To configure how persistent connections are restored

1. In the Network Option in Control Panel, double-click Client for Microsoft Networks in the list of installed components.
2. To map the drive letters when you log on without actually establishing a session for each persistent network connection, in the Network Logon Options area, click Quick Logon.

– Or –

To have Windows 95 verify each persistent network connection at startup by establishing a session for each persistent connection, click Logon And Restore Network Connections.

Quick Logon works in essentially the same way that Ghosted Connections worked under Windows for Workgroups 3.11. That is, Windows 95 initializes data structures for mapping local drives and local printer ports to network resources, but it does not physically attach to the network resource until the user tries to access it.

When you use Quick Logon (which is the default), Windows 95 can start up and return control of the user interface faster than if the physical connections are made. Because your computer might not be attached to the resource when you click a drive icon for the first time (for example, in My Computer), you might see a slight delay before the contents of that network drive are displayed. This delay is balanced against a possibly long startup time, depending on the number of persistent network connections you maintain.

Note Quick Logon requires password caching to function properly. If system policies are used to disable password caching, users cannot use Quick Logon successfully with peer servers configured with share-level security.

Windows 95 on Microsoft Networks

Running Windows 95 in a Mixed Microsoft Environment

This section presents some technical information for you to consider if your network includes computers running Windows NT or earlier versions of Microsoft networking products in addition to computers running Windows 95.

Windows 95 on Microsoft Networks

Running Windows 95 in a Mixed Microsoft Environment

Running Windows 95 with Windows NT

Microsoft Windows NT Server networks provide both client-server and peer networking with user-level security using a domain structure. You can run Windows 95 on a Windows NT network, and you can install Windows 95 for dual-booting on computers running Windows NT 3.1 or Windows NT 3.5.

The following notes summarize important issues for this configuration:

- Windows 95 and Windows NT versions 3.1 or 3.5 can be installed on the same computer, but not in the same directory.
- You cannot run Windows 95 Setup from within Windows NT. You must run Setup from MS-DOS, Windows 3.1, or Windows for Workgroups.
- If your computer has any Windows NT file system (NTFS) partitions, they will not be available locally while the computer is running Windows 95.

For a description of the support for running login scripts from Windows NT Server, see [Logon, Browsing, and Resource Sharing](#). For information about installing Windows 95 as a dual-boot operating system with Windows NT, see [Setup Technical Discussion](#).

Windows 95 on Microsoft Networks

Running Windows 95 in a Mixed Microsoft Environment

Running Windows 95 with Windows NT

Running Windows 95 in a Mixed Environment with Windows NT

In Windows 95, computers are grouped logically in workgroups, where each computer in the workgroup maintains its own security system for validating local user logon and access to resources. Computers in workgroups do not share security with other computers, and they do not rely on other computers to provide security. On Windows NT networks, computers can be grouped in domains, which allow multiple servers and workstations to be grouped for unified administration. With Windows NT domains, centralized user accounts are used to validate user logon and access to resources.

Windows 95 and Windows NT use the same workgroup model for browsing network resources, so computers running File and Printer Sharing for Microsoft Networks can appear in the same workgroup as computers running Windows NT. Computers running Windows NT will be favored in Browse Master elections because of the higher version number of the browser software.

Users running Client for Microsoft Networks can access the shared resources on a computer running Windows NT if both computers are using a common protocol. For resources protected with user-level security, the user running Windows 95 must have been granted access to those resources. Conversely, a user running Windows NT can connect to the shared resources on a computer running Windows 95 if the same conditions are met.

Windows 95 on Microsoft Networks

Running Windows 95 in a Mixed Microsoft Environment

Running Windows 95 with Windows NT

Notes on Windows NT Server Benefits

The Microsoft Windows NT Server operating system is the high-end member of the family of Microsoft Windows operating systems, providing a powerful, reliable, and scalable operating system to support the demands of client-server computing.

Windows NT Server provides the ideal platform for the server backbone in a mixed-network environment. It is especially versatile and powerful for enterprise networks made up of LANs that use a variety of network types and require dial-in support for network access. Also, on a peer-to-peer network where the computers are running Client for Microsoft Networks, you can add Windows NT to the network without changing the networking software on the existing computers.

Windows NT Server is designed to support complex business applications and administrative requirements. The following list summarizes important features.

Networking and workgroup support.

Windows NT Server provides built-in file and printer sharing capabilities for workgroup computing, and an open network system interface that includes built-in support for IPX/SPX, TCP/IP, NetBEUI, and other protocols. Windows NT Server provides administrative tools for controlling network services, auditing system events, changing hardware configuration and system performance, managing and backing up disks, and more. Windows NT also provides robust support for server-based and client-server applications.

Interoperability.

Windows NT Server is compatible with networks such as Windows 95, Banyan® VINES®, Novell® NetWare®, UNIX®, LAN Manager 2.x, and Microsoft Windows for Workgroups. Windows NT Server can add value to your current network environment without disruption. Even though networks and interoperability are complicated, a Windows NT network is easy to use and reliable, with automatic configuration provided wherever possible, and remote administration available for most administration tasks.

A single network logon.

Users can access network resources, including client-server applications, using one user account and one password per user.

Centralized management of user accounts.

The administrator can work from a single computer across divisions, departments, and workgroups.

Advanced data-protection features.

These include disk mirroring, disk striping with parity (RAID 5), and uninterruptible power supply support.

Remote Access Service (RAS).

Users can access network resources even when they are off-site, traveling, or working at home. Users can dial in over asynchronous telephone lines or Integrated Services Digital Network (ISDN) lines to access the network from computers running Windows 95, MS-DOS, Windows for Workgroups, or Windows NT operating systems. Windows NT RAS also supports X.25 networks.

Access to Apple® Macintosh® resources.

When Services for Apple Macintosh is installed on a Windows NT Server, Macintoshes and computers running Windows 95 can work together to share files, printers, and client-server applications. Macintosh users can access resources on a computer running Windows NT Server, similar to any other AppleShare® server.

Windows 95 on Microsoft Networks

Running Windows 95 in a Mixed Microsoft Environment

Running Windows 95 with Windows NT

Client Access Licenses for Windows NT Server

Windows NT Server and Windows NT Workstation are licensed separately from Microsoft, allowing you to purchase only the components you need to build a network solution for your organization. For Windows NT Server, you must have a *Server License for Microsoft Windows NT Server* for each server on the network. In addition to a Server License, a *Client Access License for Windows NT Server* is required for computers that will access or otherwise use the following basic network services:

- File services (sharing and managing files and disk storage)
- Printing services (sharing and managing printers)
- Remote access services (accessing the server from a remote location through a communications link)

Microsoft offers two licensing options for Windows NT Server:

- “Per Seat” licensing. In this case, the Client Access License applies to a specific workstation (“seat”). Using this alternative, an unlimited number of computers or workstations can access Windows NT Server, provided each one is licensed with a Client Access License. After a workstation has been licensed, it has permission to access all Windows NT Server products installed throughout your organization.

A Client Access License is required whether you use client software supplied by Microsoft or software from another vendor. In particular, for each computer running Windows 95, Windows for Workgroups, Windows NT Workstation, or any client software Windows NT Server supports, a separate Client Access License is required.

- “Per Server” licensing. In this case, each Client Access License is assigned to a particular server and allows one connection to that server for basic network services. Under this option, you designate during setup the number of licenses that apply to this server.

You can convert a Per Server license to a Per Seat license at no cost and without notifying Microsoft. You cannot, however, switch from a Per Seat option to a Per Server option. Also, all the servers in your environment are not required to be licensed using the same option — some servers can be licensed on a Per Server basis and others on a Per Seat basis.

You do not need a separate Client Access License if you access or run server applications only from Microsoft or other vendors on Windows NT Server. Examples of such server applications include Microsoft SQL Server, Microsoft SNA Server, Microsoft Systems Management Server, Lotus® Notes®, Btrieve® for Windows NT and ORACLE® Server. A Client Access License is required, however, when using utilities such as Windows NT File and Print Services for NetWare that use the basic networking services of Windows NT Server.

Note It is a violation of the terms of the Server License to access Windows NT Server without an appropriate number of Client Access Licenses. For more information, see your Server License.

Client Access Licenses are available in single-client and 20-client configurations and in volume quantities through the Microsoft Select licensing program. For more information, contact your Microsoft reseller. If you have questions, in the United States, contact the Microsoft Sales Information Center at (800) 426-9400. In Canada, contact the Microsoft Canada Customer Support Centre at (800) 563-9048. For other locations, contact your local Microsoft subsidiary.

Running Windows 95 with LAN Manager

Either Windows 95 or Windows NT Server can be installed as upgrades for all versions of LAN Manager and IBM OS/2® LAN Server, depending on the role you want that computer to serve on the network. Microsoft recommends that you upgrade these servers, rather than maintain these legacy systems on your network.

A workgroup in Windows 95 is analogous to a LAN Manager domain in that it's a logical grouping of workstations. However, a workgroup in Windows 95 does not share any of the advanced security features offered as part of a LAN Manager domain. Windows 95 does not support using a LAN Manager domain controller as a security provider, so only share-level security can be used for computers running Windows 95 on LAN Manager networks. (User-level security requires a Windows NT domain.)

To ensure computers running Windows 95 can browse for LAN Manager servers, make sure that at least one computer running Client for Microsoft Networks sets its workgroup name to the LAN Manager domain name. After a computer running Windows 95 becomes a member of the LAN Manager domain, it can distribute the names of LAN Manager servers in that domain to other computers running Windows 95 on the network. The configuration must be duplicated for each LAN Manager domain.



To ensure LAN Manager workstations can see and access resources on computers running File and Printer Sharing Services for Microsoft Networks

1. Make sure that all the computers are using a common protocol.
2. Make sure that users running LAN Manager clients have been granted access to the resources on the computers running Windows 95.
3. Set the value of the LM Announce property to Yes on each computer running Windows 95 with File and Printer Sharing services, as described in "Configuring File and Printer Sharing for Microsoft Networks" in [Logon, Browsing, and Resource Sharing](#).

The LM Announce setting ensures that the computer running Windows 95 peer resource sharing services announces its presence to LAN Manager workstations and servers. By default, the LM Announce property is set to No to reduce broadcast traffic on the network.

Tips for LAN Manager Variations

IBM OS/2 LAN Server supports a domain model and is equivalent to LAN Manager for interoperating with Windows 95. Just as with Windows for Workgroups, the Client for Microsoft Networks in Windows 95 does not support LAN Server aliases.

DEC PATHWORKS is a LAN Manager-compatible network, but it does not support a domain model for browsing servers and shared resources. DEC PATHWORKS servers will appear in Network Neighborhood.

For more information about both of these networks, see [Windows 95 on Other Networks](#).

Running Windows 95 with Windows for Workgroups

Windows 95 uses the same workgroup model as Windows for Workgroups. Because of this, computers running File and Printer Sharing for Microsoft Networks can be seen by computers running Windows for Workgroups. The Windows 95 computers will be favored in Browse Master elections because of the higher version number of the browser software.

A user running Client for Microsoft Networks can access the shared resources on a computer running Windows for Workgroups if both computers are using a common protocol. A user running Windows for Workgroups can connect to the shared resources on a computer running File and Printer Sharing for

Microsoft Networks, if both computers are using a common protocol and the user has been granted access to the resources on the computer running Windows 95.

Windows 95 on Microsoft Networks

Running Windows 95 in a Mixed Microsoft Environment

Running Windows 95 with Workgroup Add-on for MS-DOS

Computers running File and Printer Sharing for Microsoft Networks can appear in the same workgroup as a computer running the peer server supported in Workgroup Add-on for MS-DOS. For a list of peer servers to be available in the workgroup, there must be at least one computer in the workgroup configured as Browse Master that is running Windows 95, Windows for Workgroups, or Windows NT. A computer running Workgroup Add-on for MS-DOS cannot be a Browse master.

A user running Client for Microsoft Networks can access the shared resources on a computer running Workgroup Add-on for MS-DOS if both computers are using a common protocol. A user on a computer running Workgroup Add-on for MS-DOS can access resources on a computer running File and Printer Sharing for Microsoft Networks if both computers are using a common protocol, and if the user has been granted access to the shared resources.

PROTOCOL.INI: Real-Mode Network Initialization File

For real-mode networking, Windows 95 uses a file called PROTOCOL.INI in the Windows directory to determine the parameters for the protocol and network adapter drivers. Setup creates and modifies PROTOCOL.INI from information in INF files if any real-mode networking components are installed, such as NDIS 2 adapter drivers.

If you typically run Client for Microsoft Networks, the PROTOCOL.INI file on your computer is used to support Safe Mode Command Prompt Only with networking for system startup.

Caution Never edit PROTOCOL.INI manually. Actual settings are stored in the Registry, and changes in PROTOCOL.INI will be overwritten automatically. Instead, always use the Network option in Control Panel and the setup software for your network hardware to configure network settings.

The information presented in this section is for troubleshooting purposes only.

PROTOCOL.INI also contains network adapter configuration information, such as the I/O address, DMA, and IRQs. The PROTOCOL.INI file contains sections for [Protman] plus separate sections for each network adapter and network protocol.

Tip for Configuring Adapters with Real-Mode Networking

When multiple hardware adapters are used on a computer, some entries in PROTOCOL.INI, such as interrupt settings and shared memory addresses, might need adjustments to avoid hardware conflicts. Because Windows 95 Setup cannot anticipate every possible conflict, watch for error messages when you start the computer in the real-mode networking.

For example, if a network adapter and a video controller adapter both try to use the same memory address, you must adjust one of the adapters to a different address by using either the setup software for the adapter or the switches on the adapter (or both, which is the typical case). Also, the PROTOCOL.INI entries must agree with the jumper setting on each adapter.

[Protman] section.

This section provides the settings for the system component that manages protocols. The following list shows the format for this section.

[protman] entry	Description
drivername=	Entry defines the driver name for the component that manages protocols.
priority=	Entry determines the order in which incoming frames are processed.

The following shows an example of entries in this section for a computer configured with multiple NDIS protocols:

```
[protman$]  
priority=ndishlp$  
DriverName=protman$
```

[Netcard] section.

This section lists the set of parameters for an NDIS network adapter. A [netcard] section is present for each network adapter configured in the computer, and the specific entries present in this section will vary depending on the network adapter installed. The following is an example of entries in this section for an Intel® EtherExpress™ 16 or 16TP adapter:

```
[EXP16$]  
DriverName=EXP16$  
transceiver=Twisted-Pair (TPE)
```

```
iochrdy=Late
irq=5
ioaddress=0x300
```

[Protocol] section.

This section defines the settings used by a network protocol. A *[protocol]* section is present for each network transport protocol installed on the computer, and the specific entries present in this section will vary depending on the protocol installed. The following list shows the format for entries common to each configured protocol.

[protocol] entry Description

bindings= Indicates the network adapter drivers to which each transport protocol binds. The *netcard* name for the network adapter driver and protocol must appear in the **bindings=** entry for at least one of the protocol drivers. The entry can specify one or more *[netcard]* sections (separated by commas).

lanabase= For NetBIOS protocols only, defines the first LANA number the protocol is to accept.

The following is an example of entries in this section for IPX/SPX-compatible protocol and Microsoft NetBEUI:

```
[nwlink$]
DriverName=nwlink$
Frame_Type=4
cachesize=0
Bindings=EXP16$
```

```
[NETBEUI$]
DriverName=NETBEUI$
Lanabase=0
sessions=10
ncbs=12
Bindings=EXP16$
```

Introduction

This chapter presents information for installing and configuring Windows 95 on Novell® NetWare® networks.

Note For computers that use Microsoft Client for NetWare, all the files required for networking are included with Windows 95. However, Windows 95 does not include any Novell-supplied components required for real-mode NETX and VLM. For information about obtaining updates for Novell-supplied files, see [Obtaining Current Novell-Supplied Files](#).

For information about configuring Novell-supplied components and running NetWare utilities, consult your Novell documentation. For information about licensing requirements, see your Novell NetWare license agreement.

- [Windows 95 on NetWare Networks: The Basics](#)
 - [Microsoft Client for NetWare Networks: The Benefits](#)
 - [Novell-Supplied NetWare Clients: The Benefits](#)
- [Windows 95 on NetWare Networks: The Issues](#)
 - [Choosing the Network Client](#)
 - [Choosing Protocols on NetWare Networks](#)
 - [Configuring NetWare Servers to Support Windows 95](#)
- [Setting Up Windows 95 for NetWare Networks: An Overview](#)
- [Using Microsoft Client for NetWare Networks](#)
 - [Setting Up Microsoft Client for NetWare Networks](#)
 - [Configuring Microsoft Client for NetWare Networks](#)
 - [Client for NetWare Networks Technical Notes](#)
- [Using a Novell NetWare Client](#)
 - [Setting Up Windows 95 with a Novell-Supplied NetWare Client](#)
 - [Configuring Network Adapter Drivers for Novell NetWare Clients](#)
 - [NETX Technical Notes](#)
 - [VLM Technical Notes](#)
- [Technical Notes for Windows 95 on NetWare Networks](#)
 - [Obtaining Current Novell-Supplied Files](#)
 - [Search Mode with Windows 95 on NetWare Networks](#)
- [Troubleshooting Windows 95 on NetWare Networks](#)
 - [Troubleshooting Client for NetWare Networks](#)
 - [Troubleshooting Windows 95 Using Novell NetWare Clients](#)

Windows 95 on NetWare Networks: The Basics

Windows 95 runs on NetWare workstations that use Novell NetWare versions 2.15, 2.2, 3.x, and 4.x servers. You can use several different networking clients:

- The new 32-bit, protected-mode Microsoft Client for NetWare Networks
- Novell NetWare 3.x real-mode networking client (NETX)
- Novell NetWare 4.x real-mode networking client (VLM)

Note In the *Windows 95 Resource Kit*, NETX is used to refer to the Novell NetWare workstation shell for NetWare version 3.x; VLM (Virtual Loadable Module) is used to refer to the workstation shell for version 4.x.

Whichever client you choose, you can use the built-in features and commands in Windows 95 to perform most common network operation and administration tasks. Microsoft Client for NetWare Networks can process login scripts, and also supports all 16-bit NetWare 3.x and most 4.x command-line utilities for both users and administrators, so that you can use these utilities in the same way as with NETX or VLM clients running under MS-DOS or an earlier version of Windows.

Windows 95 provides complete 32-bit, protected-mode software for running on NetWare networks, including a network client (sometimes called the redirector or requestor), an IPX/SPX-compatible protocol, network adapter drivers, and administrative tools. With Microsoft Client for NetWare Networks in Windows 95, users can access NetWare server services, browse and connect to NetWare servers, and queue print jobs by using either the Windows 95 network user interface or NetWare utilities.

Whichever network client you use, the following networking features are available in Windows 95 to support computers running on NetWare networks:

- Automatic setup and customization of Windows 95 on NetWare workstations, as described in [Custom, Automated, and Push Installations](#).
- Running a shared network copy of Windows 95 for remote-boot workstations and other shared installations, as described in [Server-Based Setup for Windows 95](#).
- System policies to enforce desktop and system settings for individual or multiple computers, as described in [User Profiles and System Policies](#).
- Backup agents for Cheyenne® ARCserve and Arcada® Backup Exec, plus an agent for Simple Network Management Protocols (SNMP), as described in [Remote Administration](#).
- Complete integration of network resources in Network Neighborhood, and common controls such as the Open or Save As dialog boxes, as described in [Logon, Browsing, and Resource Sharing](#).
- Password caching for network connections and user-level security with pass-through validation to NetWare servers, as described in [Security](#).
- Printing to NetWare print queues using Point and Print. Also, the Win32-based Microsoft Print Services for NetWare Networks, available on the Windows 95 compact disc, can be used to despool print jobs from NetWare print queues to printers connected to computers running Client for NetWare Networks. For information, see [Printing and Fonts](#).

The following sections describe the different features available, depending on whether you choose to run Windows 95 using the Microsoft Client for NetWare Networks or using a Novell-supplied NETX or VLM client.

Microsoft Client for NetWare Networks: The Benefits

If you are installing Windows 95 to run on a NetWare network, Microsoft recommends that you use the Microsoft Client for NetWare Networks, which provides a 32-bit, protected-mode redirector. Client for NetWare Networks can be installed to coexist with Client for Microsoft Networks or a 16-bit network client, or it can be used as the sole network support for Windows 95. For technical information about these optional configurations, see [Windows 95 Network Architecture](#).

Architecture for Client for NetWare Network

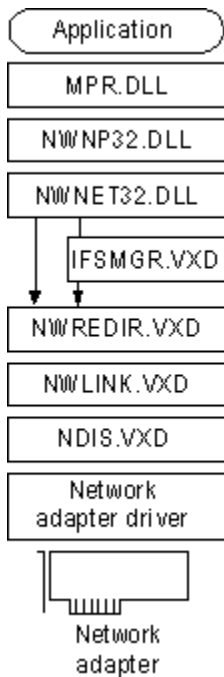

Using Client for NetWare Networks provides the following benefits.

A high-performance system using no conventional memory.

Client for NetWare Networks uses only 32-bit protocols, drivers, and supporting files. This client is designed to be used in a multitasking environment and provides the robust performance available for all protected-mode components in Windows 95, using no conventional memory space. On large block transfers over the network, Client for NetWare Networks is up to 200 percent faster than Windows 3.x with the VLM client. For most network operations that are a mix of reading and writing, Client for NetWare Networks is 50 to 200 percent faster, depending upon the mix of I/O operations.

Protected-mode peer resource sharing services.

This includes the ability to share resources such as a CD-ROM drive as a network resource. To use Microsoft File and Printer Sharing for NetWare Networks, the computer must be running Client for NetWare Networks. For more information, see [Logon, Browsing, and Resource Sharing](#).

Interoperation and logon with NetWare 2.15, 3.x, and 4.x servers.

This includes support for running NetWare login scripts. Client for NetWare Networks can access servers running NetWare 2.15 and above, NetWare 3.x servers (which are bindery-based), and NetWare 4.x servers using bindery emulation. Windows 95 provides a script processor for running login scripts.

Support for packet-burst protocol for faster data transfer.

Client for NetWare Networks with peer resource sharing supports burst-mode NCPs, a sliding window implementation. This feature can also be disabled, as described in [Logon, Browsing, and Resource Sharing](#).

Automatic reconnection for lost server connection.

When servers are available again after the loss of a NetWare Core Protocol (NCP) connection, Windows 95 reconnects automatically and rebuilds the user's environment, including connection status, drive mappings, and printer connections. (Novell-supplied AUTO.VLM only reconnects servers.) This also means that the client is not affected if the server is down or the network cable is not working.

Large Internetwork Packet (LIP) protocol support.

LIP works to increase the speed of data transmission when communication occurs over a router. Previously, if a server identified a router between itself and the client, the packet size was set to 576 bytes (including 64 bytes of header information). Using LIP, the client and server can negotiate the packet size used when communication occurs through a router. With LIP, the packets can be set to a maximum of 4202 bytes, based on the maximum physical packet size of the server. LIP is enabled between computers running Client for NetWare Networks and NetWare 3.12-4.x servers or any computer running Microsoft File and Printer Sharing for NetWare Networks.

Support for all documented MS-DOS and NetWare APIs defined by Novell.

This includes support for all NetWare 3.x APIs defined in *Novell NetWare Client SDK*. NetWare-aware applications that use only these documented APIs are compatible with Client for NetWare Networks. For more information, see [Client for NetWare Networks Technical Notes](#).

Enhanced performance and new networking features.

These features, which are made available when using protected-mode networking components, are described in detail elsewhere in the *Windows 95 Resource Kit*:

- Client-side caching for network information and complete Plug and Play support, as described in [Introduction to Windows 95 Networking](#).
- Remote network access to NetWare networks, as described in [Dial-Up Networking and Mobile Computing](#).
- User profiles for system configuration, as described in [User Profiles and System Policies](#).
- Long filenames on the local computer, on computers running File and Printer Sharing Services for NetWare Networks, and on NetWare 3.x and 4.x volumes configured to use the OS/2 name space. For information, see [Configuring NetWare Servers to Support Windows 95](#).

Windows 95 on NetWare Networks

Windows 95 on NetWare Networks: The Basics

Novell-Supplied NetWare Clients: The Benefits

Architecture for Novell real-mode clients

Novell-supplied components appear in bold

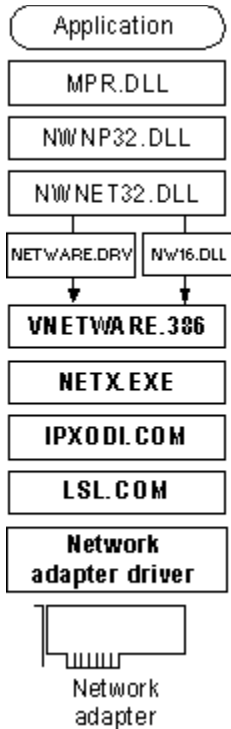

Windows 95 can be installed to use Client for Microsoft Networks in conjunction with a NETX or VLM client, or a Novell-supplied real-mode network client can be used as the sole network support in Windows 95. For technical information about these optional configurations, see [Using a Novell NetWare Client](#).

Windows 95 provides new and improved support over Windows 3.x for computers that use NetWare clients supplied by Novell, including the following.

Improved network adapter driver support.

Windows 95 networking components can be installed to work with Open Datalink Interface (ODI) network adapter drivers. This is the preferred configuration with a Novell-supplied NetWare client, and is also supported with Client for NetWare Networks. You can install Windows 95 to run with the IPX monolithic protocol stack (IPX.COM), although it is strongly recommended that you upgrade to a newer NetWare version using ODI drivers. Windows 95 can also run on NetWare networks using Datapoint Corporation ArcNet® network adapters.

Protected-mode IPX/SPX-compatible protocol.

You can use the Microsoft implementation of this protocol for network connectivity with other computers running the IPX/SPX protocol with Windows 95, Windows NT, or MS-DOS operating systems. Windows 95 also provides protected-mode NetBIOS over IPX to support NetBIOS-compliant applications, providing better performance and reduced network traffic. Alternatively, you can use the real-mode Novell-supplied driver, NETBIOS.EXE, in conjunction with the Novell-supplied real-mode client.

Compatibility with native NetWare services and commands.

Users can run native NetWare services and commands without special configuration changes in Windows 95. This includes support for NDS, NetWare IP, NCP packet signatures, 3270 emulators, TSRs, and NetWare login scripts. (Microsoft Client for NetWare Networks does not support NDS,

NetWare IP, or NCP packet signatures.)

Windows 95 on NetWare Networks

Windows 95 on NetWare Networks: The Issues

In most cases, Windows 95 Setup automatically installs Microsoft Client for NetWare Networks if it detects NetWare networking components on the computer. To install Windows 95 with Novell-supplied networking support, you must use a custom setup script that specifies the network client you want, or choose Custom and then select a Novell-supplied network client. For instructions on how to install Windows 95 with a Novell-supplied client, see [Using a Novell NetWare Client](#).

Choosing the Network Client

Microsoft Client for NetWare does not support the use of NetWare domains or the distributed name server called NetWare Naming Service (NNS). NNS is installed as an add-on product that is supported by NetWare 3.x servers. NNS uses a domain model for NetWare servers by grouping them and distributing the domain's account list to all servers in the domain. Users running NETX or VLM can log on to servers that run NNS, but cannot use NNS tools while running Windows 95.

You might choose not to use Client for NetWare Networks in these cases:

- If you want to take advantage of NetWare NCP Packet Signature for enhanced protection of servers and client computers using NCP, then you must use VLM, because Client for NetWare Networks does not support this feature.
- If your site needs to use NetWare IP, you should use NETX or VLM. Client for NetWare Networks does not support NetWare IP, and you cannot use Microsoft TCP/IP to communicate with NetWare servers using NetWare IP.
- If you use 3270 emulators that rely on DOS-helper TSRs or need 3270 emulation for applications in MS-DOS sessions, you should use NETX or VLM.
- If you are using custom VLM components such as PNW or Novell utilities such as NWADMIN or NETADMIN, you should use VLM.
- If your site needs to use NetWare Directory Services (NDS), you should use VLM. Microsoft Client for NetWare Networks does not support this feature in the release of Windows 95.

Conversely, you might choose not to use the Novell-supplied client and instead use Client for NetWare Networks in these cases:

- If you want the performance advantages of 32-bit, protected-mode network clients and network adapter drivers, including complete Plug and Play support
- If you want to take advantage of the Windows 95 unified logon and user interface for navigating the network, plus the Windows 95 network management tools
- If you want to take advantage of long filenames, client-side caching, automatic reconnections, and other performance enhancements provided in Client for NetWare Networks
- If you want to take advantage of user profiles to manage desktop configurations
- If you want to take advantage of Windows 95 peer resource sharing without running another network client

Choosing Protocols on NetWare Networks

The Microsoft 32-bit IPX/SPX-compatible protocol is an NDIS 3.1-compliant, routable protocol that conforms to the IPX specification, which requires routable datagram packets. This protocol can use Novell NetWare servers configured as routers (and other IPX routers) to transfer packets across LANs to access resources on other computers running any IPX/SPX protocol. With the Microsoft IPX/SPX-compatible protocol, it is not necessary to load the Novell-supplied VIPX.386 driver.

- The Microsoft IPX/SPX-compatible protocol is installed automatically if you install Client for NetWare Networks. However, if you configure Windows 95 to maintain the existing NetWare client and protocol software, you can later try using the protected-mode protocol provided with Windows 95. For details about installing and configuring the IPX/SPX-compatible protocol and NetBIOS over IPX, see [Network Technical Discussion](#).
- You can install both protected-mode and real-mode IPX drivers on the same adapter with ODI drivers. Notice, however, that you cannot install or use the IPX/SPX-compatible protocol to run over an IPX monolithic configuration or over ArcNet.

Client for NetWare Networks does not support NetWare IP. Microsoft TCP/IP, which is fully compliant with the standard RFCs specifying TCP/IP, cannot be used to provide TCP/IP support on NetWare networks. NetWare IP uses other protocol implementations for IP functionality, so that the two protocol suites cannot communicate with each other.

Although Microsoft TCP/IP cannot be used as the supporting protocol for Client for NetWare Networks or for Novell-supplied networking clients, Microsoft TCP/IP can be installed to support other networking clients on the same computer. Use this configuration when TCP/IP-based communications are used on the internetwork. To connect to the Internet using Microsoft TCP/IP, you do not have to install another network client in addition to Client for NetWare Networks.

Windows 95 on NetWare Networks

Windows 95 on NetWare Networks: The Issues

Configuring NetWare Servers to Support Windows 95

This section presents information about installing Windows 95 source files on NetWare servers, automating Setup for NetWare workstations, support for long filenames on NetWare servers, and where to place user profiles and system policy files on NetWare servers.

Windows 95 on NetWare Networks

Windows 95 on NetWare Networks: The Issues

Configuring NetWare Servers to Support Windows 95

Installing Windows 95 Source Files on NetWare Servers

The Windows 95 master files can be placed on a NetWare server to be used as source files for installing Windows 95 locally on NetWare workstations, or to be used as a shared copy for running Windows 95 across the network. To create a directory structure and place the Windows 95 source files on a server, you must run Server-based Setup (NETSETUP.EXE), the administrative setup program provided on the Windows 95 compact disc. (This is roughly equivalent to **setup /a** in Windows 3.x and Windows for Workgroups.)



To set up Windows 95 source files on a NetWare server

1. On the network administrator's computer, log on to the NetWare file server where you want to place the Windows 95 source files.

This should be a network computer that is running a local copy of Windows 95 and that is used only by support personnel for network maintenance. Make sure you log on with security privileges that allow you to create directories and copy files to the file server.

2. On the administrator's computer, run **castoff all** to ensure that server-to-workstation or workstation-to-workstation messages do not affect Setup.
3. Follow the procedures for copying Windows 95 source files to a server in [Server-Based Setup for Windows 95](#).

Windows 95 on NetWare Networks

Windows 95 on NetWare Networks: The Issues

Configuring NetWare Servers to Support Windows 95

Automating Setup for NetWare Workstations

You can create automatic installation procedures for installing Windows 95 on multiple workstations. The steps include the following:

- Creating setup scripts for installing Windows 95 on computers connected to NetWare networks, specifying the network client and supporting components, plus defining other software components to be installed
- Defining user and computer settings to be used in setup scripts for specific NetWare workstation configurations
- Creating login scripts to set up Windows 95 automatically on NetWare workstations when users log on

For a complete description of the procedures for preparing and managing automatic installation of Windows 95 on multiple computers, see [Custom, Automated, and Push Installations](#).

Supporting Long Filenames on NetWare Servers

Computers running Windows 95 can use long filenames on NetWare 3.x and 4.x volumes configured to use the OS/2 name space, which emulates an HPFS volume. Filenames on such NetWare volumes have a maximum length of 254 characters and use an 8.3 truncation on the first instance of the filename. For example:

```
longfilenameold.tst --> LONGFILE.TST  
longfilenamew.tst --> LONGFIL0.TST
```



To enable long filenames on a NetWare volume

1. At the NetWare server console prompt, type the following lines:

```
load os2  
add name space os2 to volume sys
```

2. Then add the following line to the STARTUP.CNF file:

```
load os2
```

3. Shut down the file server. Then copy the file OS2.NAM from the NetWare distribution disks or compact disc to the same disk and directory that contains SERVER.EXE on the NetWare file server.
4. Restart the NetWare file server.

If you have problems with this procedure, contact Novell for more information.

When you use long filenames for files on a NetWare volume while running Windows 95, the following exceptions occur:

- You cannot use a combination of short names and long names for a path used in an MS-DOS Prompt window
- You cannot use **cd** in an MS-DOS Prompt window to switch directories using first a long filename, then using a truncated name, or vice versa
- You cannot use **dir** in an MS-DOS Prompt window to check a directory on a NetWare server if you used a truncated name to switch to that directory

To avoid these problems, use Windows Explorer. Otherwise, avoid long directory names if you do a lot of work at the command prompt.

NetWare 3.11 servers experience problems with applications that open a large number of files. Error messages report these problems as sharing or lock violations, or report a "file not found" error when you know the file exists, or report other errors in opening files. Novell supplies a patch for this problem, which you can obtain from the Novell forum on CompuServe®.

However, if you have not applied the patch, this problem affects how NetWare 3.11 servers handle long filenames, even if the OS/2 name space is enabled. To avoid such problems, Windows 95 Setup only enables long-filename support with NetWare servers version 3.12 or higher.

If the NetWare patch has been applied at your site, you can ensure support for long filenames with all NetWare servers by setting **SupportLFN=2** in the following Registry key:

```
Hkey_Local_Machine\System\CurrentControlSet\Services\VxD\Nwredir
```

The possible values for this Registry key are the following:

- 0, which indicates that long filenames are not supported on NetWare servers.
- 1 (the default), which indicates that long filenames are supported on NetWare servers version 3.12 and greater.
- 2, which indicates that long filenames are supported if the NetWare server supports long filenames. This can include NetWare 3.11 servers where the patch has been applied.

These values can also be set globally using system policies. The related policy name is Support Long

Filenames under the policies for Client for NetWare Networks.

Windows 95 on NetWare Networks

Windows 95 on NetWare Networks: The Issues

Configuring NetWare Servers to Support Windows 95

Supporting Pass-Through Security for Peer Resource Sharing

If computers running Windows 95 will be providing File and Printer Sharing Services for NetWare Networks, then the NetWare server providing access validation must be configured with a special WINDOWS_PASSTHRU account. This special account is used to support pass-through validation for user-level security.

For more information about configuring and managing pass-through and user-level security for Windows 95 on NetWare networks, see [Security](#).

Windows 95 on NetWare Networks

Windows 95 on NetWare Networks: The Issues

Configuring NetWare Servers to Support Windows 95

Placing Profile and Policy Files on NetWare Servers

User profiles, which consist of the user-specific information in the Registry, can be used to ensure a consistent desktop for individual users who log on to multiple computers, or for multiple users logging on to the same computer. User profiles can be used on a NetWare network with computers configured to use Microsoft Client for NetWare Network. When a user account is created on a NetWare server, a subdirectory of the MAIL directory is created automatically for that user. Because a Mail directory is always available for each user, Windows 95 uses these individual directories to store user profiles. If you want to use user profiles to enforce a mandatory desktop, place the related USER.MAN file in the users' MAIL directories.

If you are using system policies to enforce specific desktop or system settings, the appropriate CONFIG.POL file must be stored in the SYS:PUBLIC directory on each NetWare server that users use as a preferred server. Windows 95 automatically downloads policies from this file.

For more information about using user profiles or creating system policies, see [User Profiles and System Policies](#).

Setting Up Windows 95 for NetWare Networks: An Overview

If you are administering a NetWare network, the move to Windows 95 will involve incremental planning, testing, and gradual implementation of Windows 95 on many computers on the network. Typically, the administrator will take awhile to complete the following tasks:

1. Install Windows 95 on a single workstation, and experiment with various configuration alternatives, including the following:
 - Windows 95 protected-mode network client vs. Novell real-mode client
 - Protected-mode NDIS 3.1-compliant network adapter drivers vs. real-mode Open Datalink Interface (ODI) drivers
 - Protected-mode IPX/SPX-compatible protocol vs. existing IPX
 - Using a sole client vs. adding Client for Microsoft Networks

This task includes experimenting with the typical applications used at your site and working over the network to assess the performance, reliability, and robustness available under Windows 95.
2. Prepare an implementation strategy, as summarized in [Deployment Planning Basics](#).
3. Test the selected configuration of network clients, protocols, and drivers on a small network. This could include any combinations of the following:
 - Windows 95 installed over an existing 16-bit, Novell-supplied workstation client, using ODI drivers
 - Windows 95 added to an existing Windows 3.x-and-NetWare installation, using Client for NetWare Networks and protected-mode network components
 - Windows 95 as a new installation using all protected-mode components, including both Client for NetWare Networks and Client for Microsoft Networks, plus peer resource sharing support
4. Create default user profiles, system policies, and setup scripts, and perform other customization tasks for automatic installation and configuration, based on the inventory and implementation strategy.
5. Test automatic installation on a small network.
6. Prepare and implement the strategy for rollout on the larger network.

To support Novell NetWare integration with Windows 95, any computer on which you are installing Windows 95 should be connected to a NetWare server when you start Windows 95 Setup. This requires that the computer be configured with either an ODI driver (recommended) or the monolithic IPX driver, in addition to either NETX or VLM to access resources on a NetWare server.

Windows 95 Setup detects whether a Novell NetWare workstation shell is running on the computer. If Setup finds at least version 3.26 of NET*.COM, it automatically configures networking for NetWare networks. During the detection phase, Windows 95 Setup also tries to determine whether the computer is using real-mode TSRs that cannot be replaced (such as DOSNP.COM, TCP/IP client software, or 3720 emulators).

After detection is complete, Windows 95 Setup prepares to install protected-mode networking support based on Client for NetWare Networks, unless detection has found incompatible software components or the user specifies that network support should be based on Novell-supplied components. The new Windows 95 protected-mode components are not installed automatically if detection finds the following:

- The computer is using VLM with NetWare 4.x NDS. In this case, Setup leaves all existing networking components in place.
- Certain TSRs are present that require ODI. In this case, Setup installs Client for NetWare Networks, but configures it to run over ODI.
- Certain TSRs are present that are not compatible with the protected-mode client, but can use the new implementation of the IPX/SPX-compatible protocol. In this case, the real-mode network client and adapter drivers are left in place, but Setup installs the new protocol.
- Certain TSRs are present that are not compatible with Client for NetWare Networks or other protected-mode components. In this case, Setup leaves all existing real-mode networking components in place.

To install Client for NetWare Networks and other protected-mode networking components, Setup might perform the following actions:

- Comment out NetWare-related TSRs in AUTOEXEC.BAT that are not required with Client for NetWare Networks or other Windows 95 components
- Move certain TSRs from AUTOEXEC.BAT to WINSTART.BAT so that this software can be loaded at the appropriate time during system startup
- Install new 32-bit, protected-mode versions of networking components such as protocols and network adapter drivers
- Comment out entries from SYSTEM.INI that are not required when using protected-mode networking components
- Configure settings in the Registry related to support for NetWare networks

The actions for software detection and installation of new networking components are defined in a file named NETDET.INI in the Windows directory. Installation actions are defined in NETDET.INI for the software listed in the following table. For a complete and current list, see NETDET.INI in your Windows directory.

Software detected	Windows 95 Setup default action
Btrieve® (BREQUEST.EXE)	Installs Client for NetWare Networks, with all protected-mode components
DOSNP.EXE	Keeps the real-mode IPX protocol in place
LAN Workplace®	Installs Client for NetWare Networks, but keeps the real-mode ODI network adapter and IPX protocol in place
Novell NetBIOS TSR	Installs the Microsoft IPX/SPX-compatible protocol and enables NetBIOS support
NACS/NASI (NASI.EXE)	Retains all existing Novell-supplied networking components

For information about the format of entries in NETDET.INI and how to customize this file, see [Custom, Automated, and Push Installations](#).

Windows 95 Setup automatically configures settings for network adapters and protocols. The specific issues for configuring drivers and protocols depend on whether the computer is using Client for NetWare Networks or a Novell-supplied workstation shell.

Using Microsoft Client for NetWare Networks

The redirector provided by Client for NetWare Networks (NWREDIR.VXD) is a file system driver that supports the NCP file sharing protocol for NetWare 2.15 and above, NetWare 3.x, and NetWare 4.x. Client for NetWare Networks also supports Microsoft File and Printer Sharing for NetWare Networks (NWSERVER.VXD, the NCP peer server provided with Windows 95).

This section describes how to set up and configure Client for NetWare Networks, and provides some supporting technical notes on supporting files.

For the architectural details of this configuration, see [Windows 95 Network Architecture](#). For information about logging on to a NetWare server, browsing NetWare resources, and using File and Printer Sharing for NetWare Networks, see [Logon, Browsing, and Resource Sharing](#).

Setting Up Microsoft Client for NetWare Networks

When using Client for NetWare Networks, you do not need to load any Novell-supplied drivers or components. This client runs with the Microsoft IPX/SPX-compatible protocol and NDIS-compliant, protected-mode drivers, which Windows 95 Setup installs automatically when you select this client.

When Windows 95 is installed with Client for NetWare Networks, Windows 95 Setup automatically moves any relevant NET.CFG settings to the Windows 95 Registry. You can configure the related settings using the Network option in Control Panel. You can also configure the network adapter driver and the IPX/SPX-compatible protocol, as described in [Network Technical Discussion](#).

If you did not install Client for NetWare Networks during Windows 95 Setup, you can switch to this client any time after Windows 95 is installed, as described in the following procedure. You can also install Client for NetWare Networks and configure related options when installing Windows 95 using custom setup scripts, as described in [Custom, Automated, and Push Installations](#).

Tip To display the Network option without opening Control Panel, right-click the Network Neighborhood icon on the desktop. Then click Properties on the context menu.



To add Client for NetWare Networks after Windows 95 is installed

1. In the Network option in Control Panel, examine the list of installed components.

If the computer currently has NETX or VLM installed, then select that NetWare Workstation Shell client in the list of installed components, and click Remove. Also, select and remove the IPXODI protocol if it appears in the list.

2. Click Add, and then double-click Client in the Select Network Component dialog box.

3. In the Select Network Client dialog box, click Microsoft in the Manufacturers list, and then click Client for NetWare Networks in the Network Clients list. Then click OK.

You must shut down and restart the computer for the changes to take effect.

Setup automatically installs and configures all related components. Windows 95 Setup also adds the value **lastdrive=32** to the parameters for the network client in the Registry. This value makes room for entries in a table to store drive information. For Microsoft networking, the last drive would be set to Z (or 26), but NetWare allows six additional entries in its drive table. The extra drives are used only by NetWare-aware applications; these drives are not available to users.

Windows 95 on NetWare Networks

Using Microsoft Client for NetWare Networks

Configuring Microsoft Client for NetWare Networks

This section presents information for configuring and using Microsoft Client for NetWare Networks, including the following topics:

- Configuring protected-mode NDIS network adapter drivers for Client for NetWare Networks
- Configuring Client for NetWare Networks with ODI network adapter drivers
- Running NetWare utilities with Client for NetWare Networks

For information about configuring logon options for Client for NetWare Networks, see [Logon, Browsing, and Resource Sharing](#).

Windows 95 on NetWare Networks

Using Microsoft Client for NetWare Networks

Configuring Microsoft Client for NetWare Networks

Configuring Protected-Mode Network Adapter Drivers for Client for NetWare Networks

When you install Client for NetWare Networks, a 32-bit, protected-mode, NDIS 3.1-compliant network adapter driver is installed automatically, unless the computer is running software cited in the table in [Setting Up Windows 95 for NetWare Networks: An Overview](#). If you configure Client for NetWare Networks to use ODI drivers instead, you can switch to the protected-mode drivers at any time.

Although it is possible to run Client for NetWare Networks over ODI drivers, Microsoft recommends that you install a 32-bit, protected-mode network adapter driver to take advantage of the performance improvements offered by these drivers, as described in [Network Technical Discussion](#).

For a shared installation, you must use protected-mode drivers if the computers will run Client for NetWare Networks.

Depending on when you install Client for NetWare Networks, you might have to install the 32-bit, protected-mode network adapter driver before you can install the network client. Setup prompts you to do this if it is necessary.



To switch to a 32-bit, protected-mode network adapter driver

1. In the Network option in Control Panel, double-click the network adapter in the list of installed network components.
2. In the properties for the adapter, click the Driver Type tab.
3. Click the option named Enhanced Mode (32 Bit And 16 Bit) NDIS Driver, and then click OK. Then shut down and restart the computer.

Windows 95 on NetWare Networks

Using Microsoft Client for NetWare Networks

Configuring Microsoft Client for NetWare Networks

Configuring Client for NetWare Networks with ODI Network Adapter Drivers

Architecture for protected-mode client with ODI drivers

Novell-supplied components appear in bold



You might choose to keep existing ODI drivers when using Client for NetWare Networks. The best reason for doing this is if your users need to run a TSR that requires IPX/SPX support and that is used by applications created for both Windows and MS-DOS. In this case, the TSR should be loaded by placing an entry just after the IPXODI statement in either AUTOEXEC.BAT or in WINSTART.BAT (which is the batch file used to start TSRs to be used by Windows-based applications).

Using an ODI driver instead of an NDIS 3.1 driver with Client for NetWare Networks has the following drawbacks:

- There is some use of conventional memory, and overall performance on the network is not as good as can be realized with NDIS 3.1 drivers.
- There are no Plug and Play capabilities for the networking components.
- You cannot use this configuration to run a shared installation of Windows 95.

However, you do retain the following benefits from using an ODI driver with Client for NetWare Networks instead of a real-mode network client:

- Support for long filenames
- Automatic reconnection for lost server connections
- Dial-up networking for remote access
- Client-side caching for network information

If you want to use the current ODI driver instead of a Windows 95 NDIS network adapter driver, you can select that driver using the Network option in Control Panel. For more information about using ODI drivers, see [Configuring Windows 95 with ODI Drivers](#). For information about the related files, see [Obtaining Current Novell-Supplied Files](#).



To use ODI drivers with Client for NetWare Networks

1. In the properties for the network adapter, click the Driver Type tab.
2. Click the option named Real Mode (16-bit) ODI Driver, and then click OK. Then shut down and restart the computer.

Note Shared installations that use Client for NetWare Networks cannot use real-mode ODI drivers. In this case, protected-mode networking components can be used.

Windows 95 on NetWare Networks

Using Microsoft Client for NetWare Networks

Client for NetWare Networks Technical Notes

This section presents some technical issues you should be aware of when using Client for NetWare Networks, including a summary of configuration settings and required support files, and configuration notes, plus notes about NetWare API support and running NetWare utilities with Client for NetWare Networks.

Summary of Settings for Client for NetWare Networks

The following table lists the required and possible settings for CONFIG.SYS and AUTOEXEC.BAT files if you install Client for NetWare Networks.

Configuration File Settings for Client for NetWare Networks

Filename	Required settings
autoexec.bat	None
startnet.bat ¹	None
config.sys	None

¹ The STARTNET.BAT file is a startup batch file created when VLM is installed, and is called from AUTOEXEC.BAT. This file is not required with Microsoft Client for NetWare Networks.

Notice that LOGIN.EXE is not loaded from any configuration file. Windows 95 Setup removes this entry automatically. Also, if either NETX or VLM is initialized from AUTOEXEC.BAT or another batch file, then Client for NetWare Networks will not be loaded. No real-mode drivers are needed if a network adapter driver appears in the list of installed components in the Network option in Control Panel.

The following table summarizes the minimum settings that you should see in the Network option in Control Panel if you install Client for NetWare Networks.

Required Network Settings for Client for NetWare Networks¹

Network component	Configuration options
Client for NetWare Networks	If the computer will be downloading system policies or user profiles from NetWare servers, Client for NetWare Networks should be selected in the Primary Network Logon box. In the General properties for Client for NetWare Networks, Preferred Server should show the name of the NetWare server to be used for initial logon. If login scripts are used, the option that enables login scripts should be checked.
Network adapter	In the General properties for the adapter, the driver type should be Enhanced Mode (32-Bit and 16-Bit) NDIS. ¹
IPX/SPX-compatible protocol	In its Advanced properties, the Frame Type should be Auto. If any network applications at your site require support for NetBIOS over IPX, that option should be checked in the NetBIOS properties.

¹ You can also specify 16-bit ODI drivers. You do not need to load such drivers from CONFIG.SYS or another configuration file.

Required Support Files for Client for NetWare Networks

The following table summarizes the support files required for Client for NetWare Networks. All of these files are found in the Windows SYSTEM directory and are provided with Windows 95; no Novell-supplied components are required. For more information about these components, see [Windows 95 Network Architecture](#).

Required Files for Client for NetWare Networks¹

File	Description
netware.dr	Emulates a WinNet driver required by some NetWare-

aware applications that check for this file, such as Lotus Notes®. Notice that this file is supplied with Windows 95, and is not the same as the similarly-named Novell-supplied file. (The Windows 95 version is approximately 2K in size.)

nwlink.vxd	Provides the IPX/SPX-compatible protocol.
nwlsproc.exe, nwlscon.exe	Optionally, provides the 32-bit login script processor and console used by Client for NetWare Networks.
nwnet32.dll	Provides common NetWare networking functions for the 32-bit network provider and print provider.
nwnp32.dll	Provides access to NetWare network resources using Windows Explorer, Network Neighborhood, and so on. This 32-bit network provider for NetWare networks is the service provider interface to the Multiple Provider Router.
nwpp32.dll	Provides the print provider interface to the print router in SPOOLSS.DLL. This 32-bit print provider supports the ability to print to NetWare printing resources.
nwredir.vxd	Provides a 32-bit file system driver (redirector) to support applications that use the NCP file sharing protocol.

1 These files are all supplied on the Windows 95 product disks. The NETWARE.DRV file in this configuration is a replacement for an identically named Novell-supplied file.

The following tables summarize entries that are changed automatically in configuration files when Client for NetWare Networks is installed with Windows 95.

AUTOEXEC.BAT Additions for Client for NetWare Networks

dosagent	winagent
----------	----------

AUTOEXEC.BAT Deletions for Client for NetWare Networks

bnetx	ipx	odihlp
brequest	lsl	odinsup
emsnetx	msipx	startnet
emsnet5	netbios	vlm
emsnet4	net3	xmsnet3
emsnet3	net4	xmsnet4
int2f	net5	xmsnet5
ipxodi	netx	xmsnetxp

SYSTEM.INI Additions for Client for NetWare Networks

[Boot]
networks32=nwnp32

SYSTEM.INI Deletions for Client for NetWare Networks

[386enh]	[Boot]	[boot.description]
network=	network.drv=	network.drv=
uniquedosp=		
pspincrements=		
timercriticalsection=		
reflectdosint2a=		

NET.CFG Deletions for Client for NetWare Networks

msipx

Files Renamed in Windows or SYSTEM Directories¹

nwuser.exe	nwgdi.dll	vnetware.386
netware.dr	nwpopup.exe	vipx.386
netware.hlp		

1 Files are renamed *filename.ex~*.

Client for NetWare Networks Configuration Notes

This section presents some configuration notes for Client for NetWare Networks.

- When Windows 95 attempts to connect to a NetWare server, it first silently tries to use the user's logon name and password to make the connection. If you use system policies, you can set a policy that turns off this behavior for Client for NetWare Networks. For information, see [User Profiles and System Policies](#).
- Client for NetWare Networks is always bound only to the IPX/SPX-compatible protocol. This is the only protocol this network client can use. If you require an additional protocol for your network, such as TCP/IP, you must install an additional network client, such as Client for Microsoft Networks. Notice, however, that you can install Microsoft TCP/IP to connect to the Internet without installing an additional network client.
- Windows 95 automatically provides a real-mode NetWare-compatible network client for use in emergency startup and recovery situations. It is not a full-featured, robust network client and, therefore, does not support features such as long filenames, automatic reconnection to servers, and the packet-burst (burst-mode) protocol. For more information about Safe Mode with Networking, see [General Troubleshooting](#).
- With Client for NetWare Networks, you cannot map drives for individual VM sessions; drive mappings are always global. This is the equivalent of the behavior specified in earlier versions of Windows by the SYSTEM.INI setting **NWShareHandles=True** (when using NETX or VLM). Notice, however, that with Client for NetWare Networks, each VM can have a different current directory on network drives, unlike earlier versions of Windows.
- If you are using File and Printer Sharing for NetWare Networks, then CONFIG.SYS should not have a **LastDrive=** statement.
- The NWPopUp messaging utility is not supported with Client for NetWare Networks. You can use WinPopup to broadcast pop-up messages, as described in [Network Technical Discussion](#).

Additional Settings for Client for NetWare Networks

This section describes some additional settings that can be added to the Registry for Client for NetWare Networks or for File and Printer Sharing for NetWare Networks. For information about how to add Registry values, see [Windows 95 Registry](#).

Setting maximum IPX packet size for the LIP protocol.

You can set a global value for the maximum IPX packet size for the LIP protocol. To do this, add a Registry entry named **MaxLIP** and specify a binary or DWORD value that is the greatest value allowed on any one network segment. This global setting is also used on the local network. For example, if a client on a token-ring segment (which allows 4K packet sizes) communicates over an Ethernet segment (which allows 1.5K packets) to a server on another token-ring segment, the size specified for **MaxLIP** should be limited to the lowest packet size allowed.

Add **MaxLIP** as an entry under the following Registry key:

```
Hkey_Local_Machine\System\CurrentControlSet\Services\VxD\Nwredir
```

To continue the earlier example, you would specify a value for 1.5K (0x000005DC in hexadecimal). The actual optimal value depends on the frame-header size, which is the IPX portion of the packet. You might want to experiment to get the right size but, in general, specifying a size that is too small is better than too large, because you want to make sure that the echo packet goes through on the first try.

Turning off support for packet-burst protocol.

If you want to turn off support for the packet-burst protocol (which is enabled by default for File and Printer Sharing for NetWare Networks), set **SupportBurst=0** in the following Registry key:

```
Hkey_Local_Machine\System\CurrentControlSet\Services\VxD\Nwserver
```

Setting the shell version for .OVL files.

The versions of NetWare available for the United States that run on x86-based computers use Novell-supplied IBM*.OVL (overlay) files to present the NetWare shell. This is the default assumed by Windows 95. However, other locales use other versions of .OVL files to account for different architecture. For example, NetWare 3.x J (for Japan) uses the following overlay files for various computer types.

Overlay file	Computer architecture
pc98\$run.ovl	NEC® PC9800
dosv\$run.ovl	IBM® PC-compatible
j31\$run.ovl	Toshiba® J3100
fmr\$run.ovl	Fujitsu® FMR
ps55\$run.ovl	IBM Japan

For real-mode clients, alternate .OVL files are specified in NET.CFG as the SHORT MACHINE TYPE. For Microsoft Client for NetWare Networks, alternate .OVL files can be specified as the **ShellVersion** value in the following Registry key:

```
Hkey_Local_Machine\System\CurrentControlSet\Services\VxD\Nwredir
```

The default value is **MDOS\0V7.00\0IBM_PC\0IBM\0**, where \0 indicates a binary zero (null value). This value represents the four concatenated strings returned by the INT 21 function 0xEA. You must replace the last string (0IBM) with the one used to generate the *\$RUN.OVL name. The value in the Registry must have a binary type; however, you can enter the required combination of raw ASCII and binary data in the Enter Binary Data dialog box.

Windows 95 on NetWare Networks

Using Microsoft Client for NetWare Networks

Client for NetWare Networks Technical Notes

NetWare API Support in Client for NetWare Networks

Client for NetWare Networks includes built-in support for MS-DOS-based APIs defined by Novell for NetWare 3.x, as summarized in the following table.

API for MS-DOS	Description
INT21H	Used by applications for NetWare information, bindery services, and so on
INT64 and INT7A	Used by applications to submit IPX/SPX requests

Client for NetWare Networks supports MS-DOS-based API calls documented in *Novell NetWare Client SDK*. If problems occur with applications that make proprietary or undocumented API calls, then you should use a real-mode Novell-supplied client. Also, please report this problem to both Microsoft and the application vendor.

The Windows 3.x APIs for NetWare consist of a series of DLLs provided by Novell with the version 3.x WinNet16 driver for the VLM client. The 16-bit Novell-supplied DLLs for Windows can run with Client for NetWare Networks. This ensures that Windows-based applications and utilities that are NetWare-aware will run with Microsoft Client for NetWare Networks.

If any of your applications requires one or more of these DLLs when running on a Novell-supplied client (NETX or VLM), then you must also run the same DLLs when using that application under Client for NetWare Networks.

The NetWare DLLs are described in the following list.

API for Windows	Description
nwcalls.dll	APIs for NCP communication between the file server and the client computer
nwgdi.dll	NetWare Graphical Device Interface
nwipxspx.dll	APIs for IPX/SPX communication
nwlocale.dll	APIs for localization of applications
nwnetapi.dll	Network API support for NDS
nwpsrv.dll	Print server services APIs

These Novell-supplied DLLs are not provided with Windows 95. They are provided by Novell with NetWare versions 3.12 and 4.x, and are updated on CompuServe and other electronic forums. Also, you must follow the directions provided in your Novell documentation to install these files. For information about obtaining the most recent files, see [Obtaining Current Novell-Supplied Files](#).

Windows 95 on NetWare Networks

Using Microsoft Client for NetWare Networks

Client for NetWare Networks Technical Notes

Running NetWare Utilities with Client for NetWare Networks

In addition to the 32-bit, protected-mode graphical tools built into Windows 95, you can use the 16-bit command-line utilities provided with NetWare for managing and sharing resources.

With Microsoft Client for NetWare Networks, you can run all NetWare 3.x utilities that reside on the NetWare server, such as SYSCON. You can run most NetWare 4.x utilities when you are using Client for NetWare Networks, except those that require NDS, such as NWADMIN, CX, and NETADMIN. You can also run NetWare 2.x file and printer utilities. However, you cannot use the VLM NWUSER utility with Client for NetWare Networks.

Tip To use Novell-supplied utilities such as SYSCON, map the SYS:PUBLIC directory in the login script.



To run NetWare 3.x utilities in Windows 95

1. Map a drive to the volume containing the NetWare utilities by using statements in a login script or by using the Map Network Drive dialog box.

When you use Map Network Drive, you can make this a persistent connection by clicking the Reconnect At Logon box.

2. From the Start button, point to Programs, and then click MS-DOS Prompt to start an MS-DOS session.
3. Switch to the mapped network drive, and then run the utilities in the usual way.

Using a Novell NetWare Client

Windows 95 can run with the NetWare NETX and VLM client software. Before installing Windows 95, make sure that you have the necessary Novell-supplied files for Windows support, which can be obtained from Novell.

Caution Novell-supplied components for using the NetWare client with Windows 95 require that you log on to the appropriate NetWare server before starting Windows 95. As with earlier versions of Windows, you should not log on to a NetWare server from within Windows 95.

Instead, log on to the server from AUTOEXEC.BAT or from a batch file that is called from AUTOEXEC.BAT. You should also continue to load the necessary MS-DOS-based TSR programs using AUTOEXEC.BAT or STARTNET.BAT.

For information about where a logon command should be placed in system startup files, see [Logon, Browsing, and Resource Sharing](#).

The following section describes how to set up and configure Windows 95 with a Novell-supplied client.

Windows 95 on NetWare Networks

Using a Novell NetWare Client

Setting Up Windows 95 with a Novell-Supplied NetWare Client

To help you ensure successful installation of Windows 95, make sure that the Novell-supplied NetWare client software is running before you start Windows 95 Setup. To verify that the Novell-supplied software is running, make sure you can successfully connect to and use resources on a NetWare server. Running the Novell-supplied software helps to ensure that Setup can detect the network configuration for successful installation of Windows 95.

Also, if you currently use IPX.COM, you should upgrade to the latest versions of NetWare client software that use ODI drivers before installing Windows 95. For information about using ODI drivers versus monolithic IPX.COM, see [Configuring Network Adapter Drivers for Novell NetWare Clients](#).

Installing Windows 95 with a Novell NetWare Client

This section presents the procedures for installing Windows 95 to run with a Novell-supplied client, depending on various installation situations:

- Installing Novell-supplied NetWare client support during Windows 95 Setup
- Installing Client for Microsoft Networks in addition to a Novell-supplied NetWare client
- Installing a Novell-supplied NetWare client after installing Windows 95 with no network support

Note The method for installing VLM support is different if VLM support was not installed previously under Windows 3.x, as described in [VLM Technical Notes](#).

Also notice that, if the NetWare client software is not running at the time Windows 95 is installed, you must configure Windows 95 manually after Setup to work in conjunction with the NetWare client software.

By default, Windows 95 Setup automatically installs Microsoft Client for NetWare Networks if it detects NetWare software, except in the cases described in [Setting Up Windows 95 for NetWare Networks: An Overview](#). You can select the Custom setup type and specify that the Novell-supplied software be retained during Setup. In this case, Windows 95 will use the existing networking configuration specified in NET.CFG for protocols, adapter drivers, and other values.



To select the Novell-supplied NETX client support during Windows 95 Setup

1. Start the computer as usual, making sure that the Novell-supplied network software is running. Then run Windows 95 Setup, and select Custom as the Setup type.
2. When the Network Configuration dialog box appears, select Client for NetWare Networks in the list of components, and then click Remove.
3. Click Add, and then double-click Client in the Select Network Component Type dialog box.
4. In the Select Network Client dialog box, click Novell in the Manufacturers list, and click Workstation Shell 3.X [NETX] in the Network Clients list. Then click OK.

If you also want to use Client for Microsoft Networks, follow the steps in the next procedure.

5. Click the Next button in the Network Configuration dialog box.

If you want to use only the NETX client, you do not need to specify settings for your network adapter driver or protocols. Setup automatically adds support for the ODI adapter and IPXODI (or for IPX.COM) by reading NET.CFG.

6. Continue with Windows 95 Setup.

Note You cannot install Client for Microsoft Networks as an additional network client if you are installing Windows 95 to run with an IPX monolithic configuration.



To install Client for Microsoft Networks with a Novell NetWare client

1. In the Network Configuration dialog box, click Add, and then double-click Client.
2. In the Select Network Client dialog box, click Microsoft in the Manufacturers list, and click Client for Microsoft Networks in the Network Clients list. Then click OK.



To determine whether the correct adapter driver is installed

1. In the Network option in Control Panel, double-click the network adapter (or IPX Monolithic) in the list of components.
2. In the properties for the network adapter, click the Driver Type tab.
3. Make sure the Real Mode (16 bit) ODI driver is selected.



To install a Novell NetWare client with no previous networking

1. Run the Novell-supplied installation program to install a NetWare client.

2. In the Network option in Control Panel, click Add, and then double-click Client in the Select Network Component Type dialog box.
3. In the Select Network Client dialog box, click Novell in the Manufacturers list, and click the workstation shell that you want (NETX orVLM) in the Network Clients list. Then click OK.

Windows 95 on NetWare Networks

Using a Novell NetWare Client

Setting Up Windows 95 with a Novell-Supplied NetWare Client

Switching Back to NETX from Client for NetWare Networks

If you install the protected-mode Client for NetWare Networks and later decide to return to your original Novell NetWare NETX configuration, follow these steps.

Important Be sure to use the Network option in Control Panel to remove Client for NetWare Networks, and then to configure Windows 95 to use NETX or VLM.

For details about adding or returning to VLM, see [VLM Technical Notes](#).



To return to NETX after installing Client for NetWare Networks

1. In the Network option in Control Panel, select Client for NetWare Networks, and then click Remove.
2. Click Add, and then double-click Client.
3. In the Select Network Client dialog box, click Novell in the Manufacturers list, and click Workstation Shell 3.X [NETX] in the Network Clients list. Then click OK.

Windows 95 automatically installs IPXODI support.

4. Click OK in Network properties, and provide a disk or a location for any files that Windows 95 requests to complete the installation. Then shut down and restart the computer.

Usually, you will have to reinstall Novell-supplied files at this stage, because Windows 95 Setup previously replaced these files with versions required by Client for NetWare Networks. You must also make sure that NET.CFG is present and contains correct settings, and that the required settings are present in CONFIG.SYS and AUTOEXEC.BAT. See your Novell documentation for information about these required settings.

Windows 95 on NetWare Networks

Using a Novell NetWare Client

Configuring Network Adapter Drivers for Novell NetWare Clients

This section presents some technical information related to the network adapter drivers used when configuring Windows 95 to run with Novell-supplied network clients. The topics include configuring Windows 95 with ODI drivers, monolithic IPX, or ArcNet network adapters, and setting options in NET.CFG.

NET.CFG, the Novell NetWare configuration file, is an ASCII text file that specifies various settings for the adapter, protocol, and client. For information about the format and contents of NET.CFG, consult your Novell documentation.

Windows 95 on NetWare Networks

Using a Novell NetWare Client

Configuring Network Adapter Drivers for Novell NetWare Clients

Configuring Windows 95 with ODI Drivers

The Open Datalink Interface (ODI) specification was defined by Novell and Apple® Computer to provide a protocol and a consistent API for communicating with a network adapter driver and to support the use of multiple protocols by a network adapter driver.

Note Microsoft recommends that you use ODI drivers when running Windows 95 with a Novell-supplied network client. Novell also recommends using ODI-based client software rather than monolithic IPX drivers.

Architecture for ODI drivers

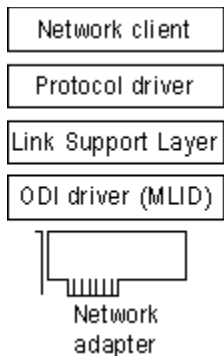

ODI consists of the following components.

An ODI-compliant version of the IPX/SPX protocol.

This component provides the network protocol for communicating between NetWare clients and servers. With NETX or VLM clients, this must be the Novell-supplied IPXODI.COM (you can also use the Microsoft IPX/SPX-compatible protocol for other network clients).

The Link Support Layer (LSL).

This component, provided in the Novell-supplied LSL.COM file, sets the foundation for network adapter drivers to communicate with multiple protocol drivers, and vice versa.

The ODI driver.

Also called the Multiple Link Interface Driver (MLID), the ODI-compliant network adapter driver is created by the adapter manufacturer. This component usually identifies the name of the supported adapter in the filename, such as NE2000.COM for the Novell NE-2000 adapter, 3c5x9.COM for the 3Com® EtherLink® III adapter, and EXP16ODI.COM for the Intel® EtherExpress™ 16 adapter. Windows 95 supports using such drivers, but these drivers are not included with Windows 95.

For information about required files, see [Obtaining Current Novell-Supplied Files](#).

Tips for Installing Windows 95 with ODI Drivers

Before you install Windows 95 on a computer, the real-mode IPXODI network should be configured and working properly using your Novell-supplied installation program. Test to confirm that there are no errors when loading the Novell-supplied files LSL.COM, IPXODI.COM, the ODI driver, and NETX.EXE, or when accessing resources on NetWare servers. If these components are running on the computer when Windows 95 is installed, Windows 95 Setup detects the drivers, identifies the network adapter, and automatically configures Windows 95 to run with the ODI drivers.

If Windows 95 Setup cannot identify the ODI driver being used, you might have to configure the network adapter driver manually. In this case, click Have Disk in the Select Network Adapter dialog box in the Network option in

Control Panel. You must provide a file for the correct IPXODI support driver to match the type of network adapter used, using a file supplied by Novell or the adapter manufacturer.

Windows 95 on NetWare Networks

Using a Novell NetWare Client

Configuring Network Adapter Drivers for Novell NetWare Clients

Setting Network Adapter Options in NET.CFG

Because a computer using ODI drivers can have multiple ODI drivers and multiple protocols loaded and bound, the networking software uses NET.CFG to identify the network adapters, protocol configuration, and binding information. NET.CFG is responsible for configuring the network environment for a Novell-supplied client, and is used to configure custom parameters for NETX, IPX, NetBIOS, or the general NetWare environment. To configure any options, edit NET.CFG as described in your Novell documentation.

Monolithic IPX (IPX.COM) does not require a settings file because there is only one protocol and one network adapter driver bound together in a specific way. The IPX.COM file contains all network adapter configuration information.

NetWare began using SHELL.CFG as the configuration filename with monolithic IPX and is now using NET.CFG for ODI. NET.CFG is the preferred file to use and has some specific uses for ODI. Neither SHELL.CFG nor NET.CFG is required for a NetWare client computer. If these files do not exist, default settings are used. If both SHELL.CFG and NET.CFG exist, both are processed (first SHELL.CFG, then NET.CFG).

If you are using ODI drivers, the Novell-supplied LSL.COM file uses information from NET.CFG to configure the ODI driver before the NETX workstation shell does. For the LSL driver to load and initialize information from NET.CFG, the proper NET.CFG file should reside in the same directory as LSL.COM and the Novell-supplied NETX.EXE network client. To verify that there is not more than one NET.CFG file present on a computer, type **dir /s net.cfg** at the command prompt (or from the Start button, click Find and search for NET.CFG).

Network adapter configuration information is contained in a **Link Driver** section in NET.CFG, where you can specify the network adapter's interrupt, I/O address, memory address, frame types, and protocols. For example, the following example shows NET.CFG entries for an SMC® Ethercard Plus Elite 16 adapter:

```
show dots=on
file handles=60
preferred server=nw_311
link driver smc8000
    int 5
    port 240
    mem d000
    frame ethernet_802.3
```

The following table describes selected information commonly found in NET.CFG under the **Link Driver** section. For information not found in NET.CFG, default settings for the network adapter are assumed. For more information, consult your Novell documentation.

Network Adapter Driver Settings in NET.CFG

NET.CFG setting	Description
DMA	DMA channel number. Can assign up to two DMA channels by designating them DMA #1 x and DMA #2 y.
FRAME	Alternate Media Access Control (MAC) layer frame encapsulations for the network adapter. The default is ETHERNET_802.3 if not specified. Frame types are the following:

	ETHERNET_802.3	ETHERNET_SNAP
	ETHERNET_802.2	TOKEN_RING
	ETHERNET_II	TOKEN_RING_SNAP
INT	IRQ number. Can assign up to two IRQs by designating them IRQ #1 x and IRQ #2 y.	
MEM	Memory address in upper memory area (UMA). Can assign up to two UMA addresses by designating them MEM #1 x and MEM # y.	
NODE ADDRESS	New 12-digit MAC address assigned to the network adapter.	
PORT	I/O port address. Can assign up to two I/O port addresses by designating them PORT #1 x and PORT #2 y.	
PROTOCOL	Protocols to be used with ODI drivers. You do not need to specify this in NET.CFG if NETX is running only IPX and no other protocol. If other protocols are running, you must specify the protocol, protocol ID, and the frame type.	
SLOT	Network adapter slot number (MCA, EISA).	

Configuring Windows 95 for Monolithic IPX

Although the monolithic IPX legacy configuration is supported in Windows 95, Novell recommends that the ODI client software be used instead of dedicated IPX drivers. Notice particularly the following exceptions for monolithic IPX:

- If you want to install Windows 95 with monolithic support, all networking components must be installed and working before you install Windows 95.
- If you want to use Client for NetWare Networks with ODI drivers, you should first upgrade your Novell-supplied networking software to a recent version of the ODI client software.
- You cannot install any Windows 95 protected-mode networking components if you are using the IPX monolithic configuration.
- You cannot install monolithic support under Windows 95 if the workstation has Novell-supplied VLM software installed.

Caution Microsoft strongly recommends upgrading to 32-bit, protected-mode software for a computer running Windows 95 on NetWare networks.

If you must use Windows 95 on monolithic IPX, then configure the real-mode monolithic IPX network and verify that it is working properly before installing Windows 95. Test to confirm that there are no errors when loading IPX.COM and NETX.EXE or when accessing resources on NetWare servers.

Architecture for monolithic IPX

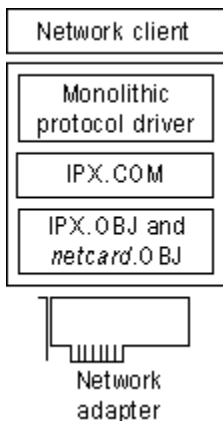

The monolithic implementation of the IPX protocol, IPX.COM, includes a single driver file that contains both the IPX/SPX protocol stack and the network adapter driver for communicating with the network adapter. IPX.COM must be configured for each computer based on the network adapter and its hardware configuration (IRQ, I/O address, RAM address in the upper memory area, and DMA channel). IPX.COM is generated from the IPX.OBJ file and a particular network adapter driver file (*netcard.OBJ*) using the NetWare SHGEN or WSGEN programs.



To add monolithic IPX after Windows 95 is installed

1. In the Network option in Control Panel, select all installed networking components, and then click Remove.
2. Click Add, and then double-click Adapter in the Select Network Component Type dialog box.
3. From the Manufacturers list in the Select Network Adapters dialog box, click Novell. From the Network Adapters list, click Novell IPX Monolithic Driver. Then click OK.
4. Shut down and restart the computer for the changes to take effect.

An entry will appear for Novell IPX Monolithic Driver in the list of installed components in the Network option in Control Panel. For information about required files, see [Obtaining Current Novell-Supplied](#)

Files.

Windows 95 on NetWare Networks

Using a Novell NetWare Client

Configuring Network Adapter Drivers for Novell NetWare Clients

Configuring Windows 95 with ArcNet Network Adapters

Windows 95 supports connectivity to Novell NetWare servers and other computers running Windows 95 over an ArcNet network. To configure Windows 95 to support NetWare over ArcNet, you must use NETX or VLM with real-mode IPX drivers on ArcNet network adapters, with NetBIOS support. This is true whether you are using a monolithic IPX driver or an ODI ArcNet driver.

You cannot use the Windows 95 IPX/SPX-compatible protocol or Client for Microsoft Networks with ODI drivers. If you are running Client for Microsoft Networks to connect to other Microsoft networking computers on an ArcNet network, you must also install NDIS 2 network adapter drivers and another protocol used in the network, such as NetBEUI. (Notice that in this configuration, you cannot also access a NetWare network.)

If the ArcNet driver and NetWare workstation shell are running when Windows 95 is installed, Windows 95 Setup detects the configuration and automatically installs the proper components. However, if the computer is using a generic ArcNet driver or if Windows 95 is unable to detect an ArcNet driver, you might have to configure Windows 95 manually to run on an ArcNet configuration. You will also need to install the ODI ArcNet Support transport with NetBIOS. If Windows 95 Setup can detect the configuration properly, this network protocol is installed automatically for an ODI ArcNet driver.

Windows 95 on NetWare Networks

Using a Novell NetWare Client

NETX Technical Notes

This section describes specific notes related to using the Novell-supplied NetWare 3.x client software with Windows 95.

Using NETX with Client for Microsoft Networks

When running NETX with Windows 95, you keep all the same functionality that you had when running with MS-DOS or Windows 3.x. You also gain the features described in [Windows 95 on NetWare Networks: The Basics](#).

If you are using NETX as the network client, you might also choose to install the 32-bit, protected-mode Client for Microsoft Networks if you want to connect to other Microsoft network computers, such as computers running Windows for Workgroups 3.x, LAN Manager, or Windows NT.

When you run the NetWare NETX client with Windows 95 in this configuration, you should continue to load the necessary Novell-supplied client components and MS-DOS-based TSR programs (LSL, ODI driver, IPXODI, and NETX) in AUTOEXEC.BAT or STARTNET.BAT, just as you did with MS-DOS or Windows 3.1. Windows 95 Setup automatically adds the configuration settings if they are not present. For information about required configuration settings, see your Novell documentation.

Notice that this configuration requires a Microsoft Windows NT Client Access license if the computer will be connecting to servers running Windows NT Server. For information, see [Windows 95 on Microsoft Networks](#).

Architecture for Novell-supplied NETX with Client for Microsoft Networks

Novell-supplied components appear in bold

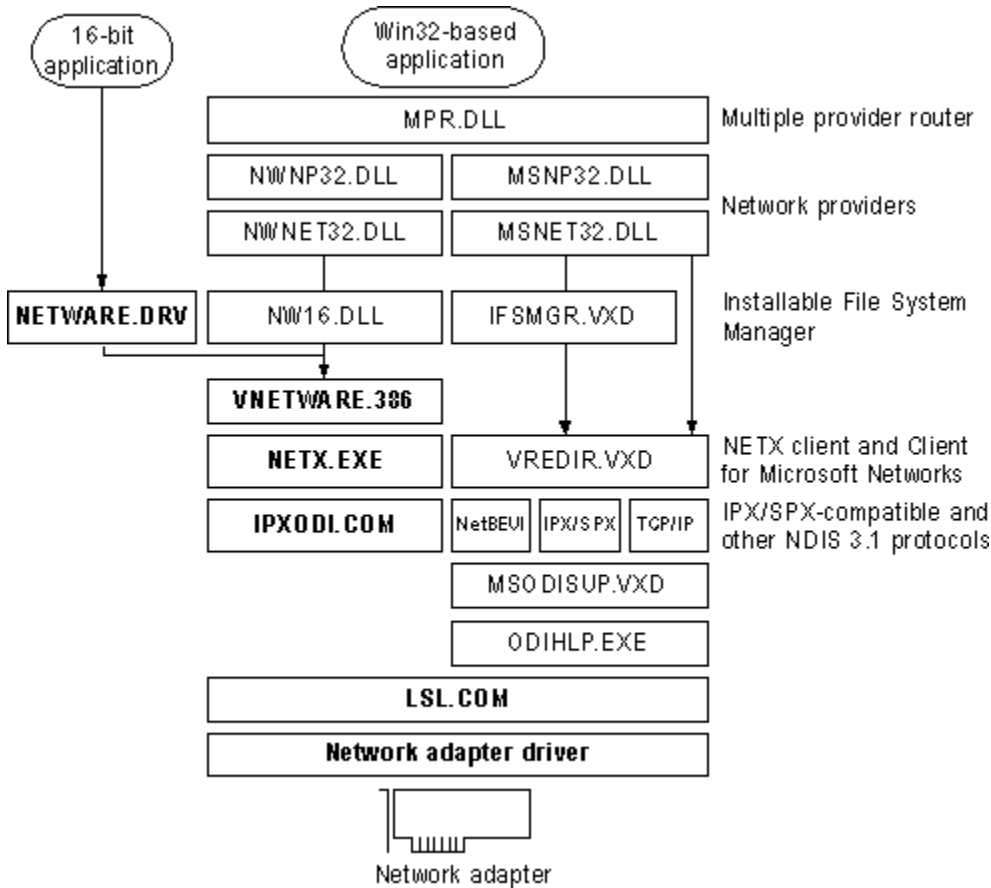

In this configuration, the Novell-supplied version of NETWARE.DRV is installed and loaded only for applications that call it directly. Because this driver is not used by Windows 95, all access to NetWare resources occurs by using the Windows 95 user interface, not the NETWARE.DRV dialog boxes

provided by Novell. The NW16.DLL component translates 32-bit network calls to 16-bit network calls that can be passed to VNETWARE.386.

Note You cannot install Client for Microsoft Networks as an additional networking client if you are using the IPX monolithic configuration.

Using NETX as the Sole Client

This configuration is for use in either of these cases:

- The IPX monolithic configuration is used.
- You do not need to connect to other computers running Windows for Workgroups 3.x, LAN Manager, or Windows NT. Of course, you can connect to computers running Microsoft File and Printer Sharing Services for NetWare.

To use only NETX client support, use the Network option in Control Panel to remove Client for NetWare Networks and Client for Microsoft Networks, if either of these clients is installed. Then add the Novell NetWare (Workstation Shell 3.X [NETX]) client, as described in [Installing Windows 95 with a Novell NetWare Client](#).

Architecture for Novell-supplied NETX as the sole client

Novell-supplied components appear in bold

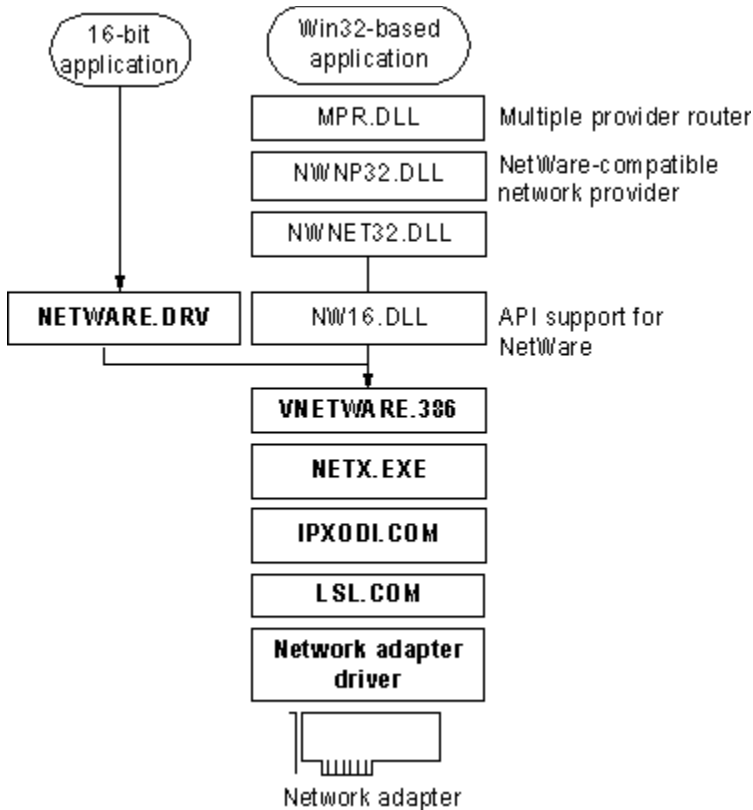

The following table lists the required settings for CONFIG.SYS and AUTOEXEC.BAT files if you use NETX as the sole network client.

Configuration File Settings for NETX as the Sole Client

Filename	Required settings
config.sys	lastdrive= <i>drive letter</i>
autoexec.bat	lsl.com odi_driver ipxodi.com netx.exe q: ; that is, lastdrive+1

```
login
c:
```

1 Or this could be the name of a batch file called from AUTOEXEC.BAT.

The following table summarizes the minimum settings that you should see in the Network option in Control Panel if you use NETX as the sole client.

Network Settings for NETX as the Sole Network Client

Component	Options
NetWare (Workstation Shell 3.X [NETX])	Novell NetWare (Workstation Shell 3.X [NETX]) should appear in the list of installed components. All other settings are configured in NET.CFG.
Network adapter	In the General properties for the adapter, the option named Real Mode (16-Bit) ODI Driver should be checked.
Novell IPXODI	Settings are configured in NET.CFG.

Windows 95 on NetWare Networks

Using a Novell NetWare Client

NETX Technical Notes

Setting the LastDrive Parameter for NETX

Windows 95 uses the value of the **LastDrive=** entry in the Registry (or CONFIG.SYS) to allocate enough storage space in the internal memory structures to recognize drive letters for devices. For example, a setting of **LastDrive=Z** tells Windows 95 to recognize drive letters from A to Z.

Windows 95 uses all drive letters up to the letter assigned as the last drive. NetWare servers use all the drive letters following the last drive. For example, if **LastDrive=P** is specified, you can assign drive letters D through P for networks other than NetWare (assuming drive C is the only physical hard disk drive in the system). In this same example, NetWare begins mapping NetWare volumes with Q.

Unlike Windows 95 for Workgroups, Windows 95 does not update the value of the **LastDrive=** if a value is already set. If no value is specified in CONFIG.SYS, Windows 95 adds **LastDrive=E** to the Registry.

Setting Show Dots and File Access Limits

A NetWare file server does not include the directory entries dot (.) and double dot (..) as MS-DOS and Windows 95 do. However, the NetWare workstation shell version 3.01 or later can emulate these entries when applications attempt to list the files in a directory.



To turn on the Show Dots feature

- If you have problems listing files or deleting directories, add the following line to the beginning of NET.CFG:

```
show dots=on
```

By default, NetWare client software allows you access to only 40 files at a time. When you are running many applications under Windows 95, it is possible to exceed this limit, so you will want to increase the settings for file limits.



To increase the file access limit

1. Add the following line to the beginning of NET.CFG:

```
file handles=60
```

2. Add the following to CONFIG.SYS for the local computer:

```
files=60
```

Windows 95 on NetWare Networks

Using a Novell NetWare Client

VLM Technical Notes

VLM, the network client provided with Novell NetWare version 4.x, provides the same support and behavior under Windows 95 as it does under MS-DOS or Windows 3.1. In addition, you gain the benefits described in [Microsoft Client for NetWare Networks: The Benefits](#).

If the computer is using VLM, you should still load the Novell-supplied client components and TSR programs, and log on from either AUTOEXEC.BAT or STARTNET.BAT. Login scripts also work in the same way they do with MS-DOS and Windows 3.x. After Windows 95 starts, you can use the Windows 95 user interface to make drive and printer connections, or you can run NetWare utilities by running NWUSER or other commands at the command prompt. Notice, however, that you cannot use NDS names in Windows 95 dialog boxes.

Installing Windows 95 with the VLM client requires special steps if an earlier version of Windows is not installed, as described in this section. This section also presents specific notes related to using the Novell-supplied NetWare 4.x client software with Windows 95.

Setting Up Windows 95 with VLM

If you install Windows 95 into the existing Windows directory on a computer where VLM is already configured to run with an earlier version of Windows, then to install VLM support, follow the steps described in [Installing Windows 95 with a Novell NetWare Client](#).

However, if you are installing Windows 95 into a new directory, or if you are installing it on a computer that has only the MS-DOS operating system (but no earlier version of Windows), you must follow special steps to set up the computer properly. This is because Windows support for VLM requires software supplied only through the Novell-supplied VLM installation program. Follow the instructions under the procedure in this section that most closely describes your configuration.

Windows 95 Setup tries to detect VLM by looking for an NLS directory. If NLS is present, it begins installing Windows 95 for VLM. If the NLS directory is not present but you select the VLM client to install in Setup, Windows 95 Setup asks you to first install VLM using the Novell installation program. Then you can continue with Windows 95 Setup.

Important Automatic logon for the NetWare network from AUTOEXEC.BAT needs to be configured before running Windows 95 Setup; otherwise, your login script will not be run under Windows 95 (and therefore any mapped drives will not be available).



If you already run VLM with Windows 3.x and install Windows 95 over Windows 3.x

- Start the computer as usual, and make sure that the Novell software is running. Then run Windows 95 Setup and choose support for Novell NetWare 4.0, as described in [Installing Windows 95 with a Novell NetWare Client](#).
- Or –
- 1. After Setup is complete, in the Network option in Control Panel, select Client for NetWare Networks (if this has been installed), and then click Remove.
- 2. Click Add, and then double-click Client.
- 3. In the Select Network Client dialog box, click Novell in the Manufacturers list, and click the option named Novell NetWare (Workstation Shell 4.0 and above [VLM]) in the Network Clients list. Then click OK.
- 4. If you want to install Client for Microsoft Networks at this time, you can repeat the steps in the Select Network Client dialog box to install it. Then shut down and restart the computer.



If you already run VLM with Windows 3.1 and install Windows 95 in a new directory, or if you are running VLM with MS-DOS

1. Start the computer as usual, making sure that the Novell-supplied network software is running. Then run Windows 95 Setup, and select Custom as the setup type.
2. When the Network Configuration dialog box appears, select Client for NetWare Networks in the list of components (if this has been installed), and then click Remove.

Note If you were logged into NDS when Setup was started, then VLM appears in this list and you can skip the following steps.

3. Click Add, and then double-click Client in the Select Network Component Type dialog box.
4. In the Select Network Client dialog box, click Novell in the Manufacturers list, and click Novell NetWare (Workstation Shell 4.0 And Above [VLM]) in the Network Clients list. Then click OK.
Setup partially configures Windows 95, and then prompts you to run the Novell Workstation Shell Install program after Windows 95 has been installed.
5. Setup places information in AUTOEXEC.BAT that instructs you to run the Novell Workstation Shell Install program, after the Copying Files phase is complete. Complete this step to install the Novell-supplied support for Windows.

Note Setup also places the entry **device=vnetbios** in SYSTEM.INI, which causes a blue screen to

appear when you restart the computer. You can ignore this screen.

6. Restart the computer again, and let Windows 95 start normally.

In the Network option in Control Panel, you will see that Setup has added Novell NetWare (Workstation Shell 4.0 And Above [VLM]) as a network client. Information in NET.CFG is used to configure the other network components.

For information about required files, see [Obtaining Current Novell-Supplied Files.](#)

Using VLM with Client for Microsoft Networks

If you are using VLM as the network client, you might also choose to install the 32-bit, protected-mode Client for Microsoft Networks if you want to connect to other Microsoft networking computers, such as computers running Windows for Workgroups 3.x, LAN Manager, or Windows NT. The following illustration describes this configuration.

Architecture for Novell-supplied VLM with Client for NetWare Networks

Novell-supplied components appear in bold

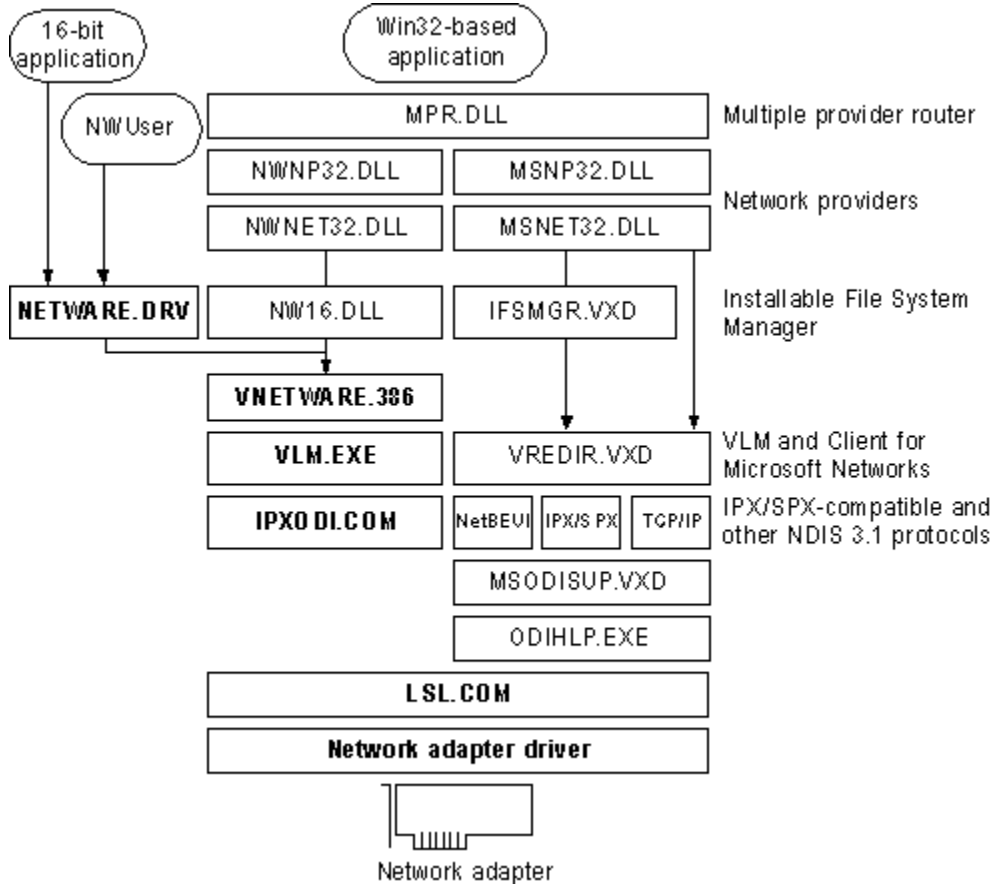

In this configuration, the Novell-supplied version of NETWARE.DRV is not used by Windows 95. It is installed and loaded only for applications that call it directly. All access to NetWare resources is through the Windows 95 user interface, not the NETWARE.DRV dialog boxes. The NWUSER utility calls NETWARE.DRV directly to bring up the central NetWare Version 3.0 WinNet16 dialog box.

Notice that this configuration requires a Microsoft Windows NT Client Access License if this computer will be connecting to servers running Windows NT Server. For more information, see [Windows 95 on Microsoft Networks](#).

Using VLM as the Sole Client

This configuration can be used if you do not need to connect to other computers that are running Windows for Workgroups 3.x, LAN Manager, or Windows NT. (Of course, you can connect to a Windows 95 computer running Microsoft File and Printer Sharing for NetWare.)

The following illustration summarizes this configuration.

Architecture for Novell-supplied VLM as the sole client

Novell-supplied components appear in bold

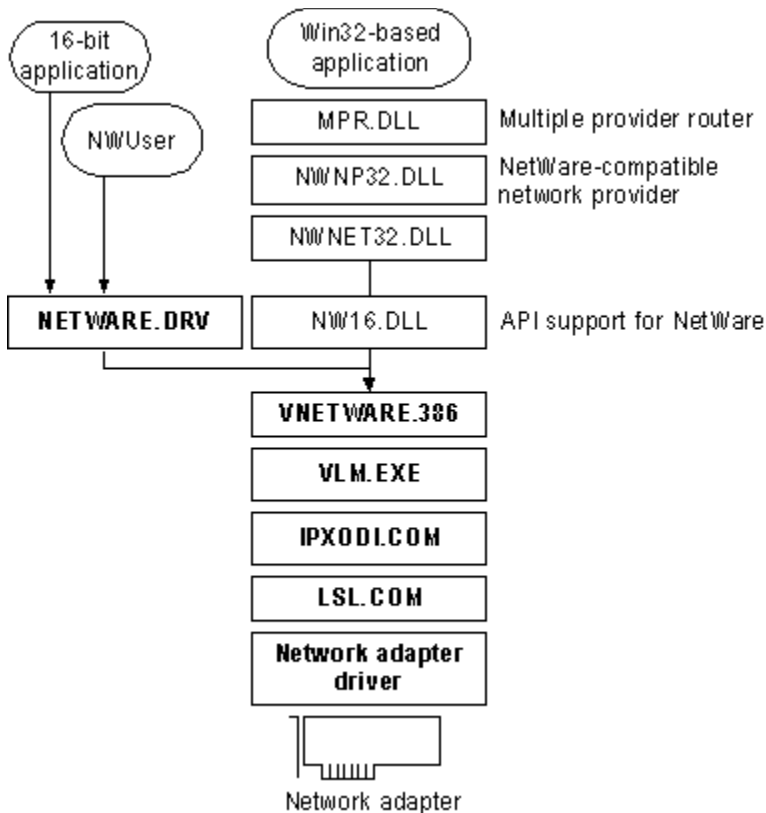

The following table lists the required settings for CONFIG.SYS and AUTOEXEC.BAT files if you use VLM as the sole network client.

Configuration File Settings for VLM as the Sole Client

Filename	Required settings
config.sys	lastdrive= <i>drive_letter</i>
autoexec.bat	startnet.bat
startnet.bat	lsl.com odi driver ipxodi.com vlm.exe f: ; that is, first network drive in net.cfg login c:

The following table summarizes the minimum settings that you should see in the Network option in Control Panel if you install Windows 95 with VLM as the sole client.

Network Settings for VLM as the Sole Client

Component	Options
NetWare (Workstation Shell 4.X [VLM])	Novell NetWare (Workstation Shell 4.X [VLM]) appears in the list of installed components. All other settings are configured in NET.CFG.
Network adapter	In the General properties for the adapter, the Real Mode (16 Bit) ODI Driver option should be checked.
Novell IPX ODI	Settings are configured in NET.CFG.

Windows 95 on NetWare Networks

Using a Novell NetWare Client

VLM Technical Notes

Setting the LastDrive Parameter for VLM

Windows 95 uses the value of the **LastDrive=** entry in the Registry to allocate enough storage space in the internal memory structures to recognize drive letters for devices. For example, a setting of **LastDrive=Z** tells Windows 95 to recognize drive letters from A to Z.

The Novell-supplied NetWare 4.x redirector handles the **LastDrive=** entry the same way that Windows 95 does. That is, both the NetWare 4.x redirector and Windows 95 allow drive letters to be used to connect to redirected network drives up through the drive letter specified by the **LastDrive=** entry.

The NetWare 4.x redirector uses the **First Network Drive=** entry in the NET.CFG file to identify the first network drive that can be mapped. For more information about this setting, consult your Novell documentation.

Windows 95 on NetWare Networks

Technical Notes for Windows 95 on NetWare Networks

This section contains information about obtaining current Novell-supplied files and technical notes on the IPX/SPX-compatible protocol and Microsoft TCP/IP.

Obtaining Current Novell-Supplied Files

If your computer is not configured with the necessary NetWare software, or if you don't have the support files that Windows 95 Setup requires to configure your computer, several sources are available for these files.

Important Use the latest available version of Novell-supplied driver files. At the release of Windows 95, the following were some of the current files posted on the Novell forum on CompuServe: DOSUP9, WINDR2; WINUP9, and VLMUP9.



To obtain current NetWare software files

- Check with your NetWare network administrator or your local Novell representative to see if the latest client files are available locally.
 - Or –
 - Over the Internet, obtain files from [ftp.novell.com](ftp://ftp.novell.com).
 - Or –
 - Check the Novell Files forum on CompuServe by typing **go novlib** at a system prompt. Novell posts revisions of NetWare client software and drivers on this forum.

Required Support Files for Novell-Supplied Clients

In addition to the base Novell-supplied NetWare client software required to communicate with a NetWare server, some additional NetWare support files are necessary for the Novell-supplied components to work properly in the Windows 95 environment. When Windows 95 is configured to support a Novell NetWare client, Setup checks to see if the required supporting files for Windows are in the Windows directory. If the files are not in the Windows directory, Setup asks for a disk or network drive location for these files.

The required Novell-supplied supporting files for NetWare connectivity under Windows are shown in the following list.

Novell-Supplied Files for Windows Support

File	Description
netware.driv, netware.hlp	Windows-compatible network driver and associated help file to provide access to network redirector functionality from 16-bit applications. Notice that this must be the version 2.x WinNet16 driver for the NETX client. Also, the Novell-supplied version of NETWARE.DRV for NETX is approximately 124K in size; for VLM, the size is approximately 144K or 162K, depending on the version.
nwpopup.exe	NetWare messaging utility. Used to receive messages and alerts from a NetWare server.
vnetware.386	Virtual device driver providing virtualization services for the NetWare redirector in the Windows environment and across VMs.
vipx.386	Virtual device driver providing virtualization services for the NetWare IPX protocol for the Windows environment and across VMs.
nw16.dll ¹	A thunk layer for passing 32-bit calls to 16-bit NETX APIs.

¹ Required for VLM, but not for NETX.

Required Support Files for ODI Drivers

A computer using Novell-supplied ODI and the IPX/SPX protocol requires certain files, depending on whether you choose to keep the Novell-supplied client when installing Windows 95 on a NetWare network.

Required Files for ODI Drivers with Novell-Supplied Client

Windows 95 drivers:

vnetbios.386

Novell-supplied NETX drivers:

ipxodi.com	netware.hlp	vipx.386
lsl.com	netx.exe	nnetware.386
netware.driv	nwpopup.exe	

A network adapter driver such as ne2000.com

Novell-supplied VLM drivers:

netx.vlm, version 4.0 or later

VLM client supporting files, version 1.02 or later

Required Files for ODI Drivers with Microsoft Client for NetWare Networks

Windows 95 drivers:

msodisup.vxd ¹	nwnblink.vxd	nwredir.vxd
ndis.vxd	nwnet32.dll	odihlp.exe
nwlink.vxd	nwnp32.dll	vnetbios.386

Novell-supplied drivers:

lsl.com

A network adapter driver such as ne2000.com

- ¹ MSODISUP.VXD is the ODI support layer that maps NDIS 3.1 protocols to an ODI driver, and ODIHLP.EXE is the real-mode stub that allows LSL to complete its binding process in real mode.

Windows 95 on NetWare Networks

Technical Notes for Windows 95 on NetWare Networks

Obtaining Current Novell-Supplied Files

Required Support Files for Monolithic IPX

After Windows 95 is installed on a monolithic IPX configuration, the required drivers include the following files, which must all be supplied by Novell:

ipx.com	netware.hlp	vnetware.386
netware.driv	netx.exe	vipx.386.

Windows 95 on NetWare Networks

Technical Notes for Windows 95 on NetWare Networks

Obtaining Current Novell-Supplied Files

Required Support Files for ArcNet Drivers

This configuration is similar to configuring Windows 95 to run with a monolithic IPX driver, except that Novell-supplied ODI drivers are used. The drivers used in this configuration include the following files, which must all be supplied by Novell:

smc8000.com (ODI driver)	netware.driv	vnetware.386
lsl.com	netx.exe	vipx.386
ipxodi.com		

Windows 95 on NetWare Networks

Technical Notes for Windows 95 on NetWare Networks

Search Mode with Windows 95 on NetWare Networks

Many applications, when started, also open a number of other files (such as overlay files and data files) that are used as application resources. To find these files, older NetWare-aware applications, such as the FILER version 3.x NetWare utility, look for files in NetWare search drives in these ways:

- Using the PATH environment to search for executable files
- Using a NetWare search path to find supporting files, such as required data files

Under Windows 95, the search mode defines how files are found, depending on the network client you use, as described in the following table.

Client	Search mode
Client for NetWare Networks	Search from a drive mapped to the server where the utility is stored

Novell-supplied NETX	Search from any local drive or any network drive
Novell-supplied VLM	Search from any network drive. Cannot search from a local drive

If you see an error message that a supporting file could not be found, the search mode is not set properly, or you are not opening the application from the correct place. For example, in FILER, the message might be: "System message library file SYS\$MSG.DAT could not be opened." In such a case, you will have to set the search mode.

Note Most newer NetWare-aware applications and utilities, such as SYSCON, do not use search mode to find auxiliary files.



To set the search mode in Windows 95

1. From the File menu in System Policy Editor, click Open Registry. Then click the icon for Local Computer.

For more information about using System Policy Editor in Registry mode, see [User Profiles and System Policies](#).

2. Click Network, click Microsoft Client for NetWare Networks, and then click Search Mode.
3. Specify a setting based on the table following this procedure. Then shut down and restart the computer.

You can also use system policies to define the search mode for multiple computers.

Search Mode has five settings: Modes 1 (also shown as 0), 2, 3, 5, and 7. (Modes 4 and 6 are not used currently.) Check your application documentation to determine whether the application only reads its supporting files, or reads and writes to them. The search mode applies to all applications that use it, so select the mode that works for most programs.

Search mode	Meaning
0 or 1	Uses the default search mode. Client for NetWare Networks will look in the search drives only when no path is specified in the application and after the default directory has been searched.
2	Causes Client for NetWare Networks not to look in any search drives to find supporting files. The application will behave as if you were running it without networking. If the application has a defined directory path for searching and opening files, the application searches for the files in that path. NetWare calls this mode "Do not search."
3	The same as Mode 1, except that if the application has no defined directory path to search and open files, Client for NetWare Networks looks in the search drives only if the open request is a read-only request. NetWare calls this mode "Search on Read-Only opens with no path."
5	Causes Client for NetWare Networks to always look in the search drives, even if the application specifies a path. NetWare calls to this mode "Search on all opens."
7	The same as Mode 5, except that Client for NetWare Networks looks in the search drives only if the open request is a read-only request. NetWare calls this mode "Search on all Read-Only opens."

whether you are running Microsoft Client for NetWare Networks or a Novell-supplied network client.
For more troubleshooting tips related to system logon and browsing on NetWare networks, and for File and Printer Services for NetWare Networks, see [Logon, Browsing, and Resource Sharing](#).

Troubleshooting Client for NetWare Networks

This section discusses some common problems that might occur while installing, configuring, or using Microsoft Client for NetWare Networks.

As a general troubleshooting step, make sure that the version of NETWARE.DRV is a size of about 2K. If it is much larger, remove Client for NetWare Networks in the Network option in Control Panel, and then reinstall it.

No network is available after Windows 95 starts.

Verify that Client for NetWare Networks is installed. Use the Network option in Control Panel to view a list of installed clients, protocols, and services. Verify that the IPX/SPX-compatible protocol is in the list of installed components.

The login script does not run.

Make sure the correct preferred server is set and that Enable Login Script Processing is checked in the properties for Client for NetWare Networks.

NetWare servers can't be found.

You might not be able to see NetWare servers if you are using an incorrect frame type for the servers. To ensure that you are using the correct frame type for the server, verify the frame type set in the Advanced properties for the IPX/SPX-compatible protocol in the Network option in Control Panel. You can switch the setting from Auto to the specific frame type used on the server.

Client for NetWare Networks supports NetWare 4.x bindery emulation. Be sure that the bindery context you set for your NetWare server directory includes the Windows 95 users who should have access to the servers. To view and set your bindery context on NetWare 4.x servers, load the SERVMAN NetWare loadable module (NLM) and then view and set the SET BINDERY CONTEXT parameter. Or, you can type **set** at the command prompt to view the miscellaneous SET parameters. For more information, see your NetWare 4.x server documentation.

You are asked for a Windows 95 password and a NetWare password at each logon.

Client for NetWare Networks asks for a Windows 95 password after you log on to the network because the user name and password for your NetWare preferred server differs from your Windows 95 password. If you don't want to be prompted for a second password, make the passwords the same for both the NetWare preferred server and Windows 95.

Access to NetWare servers is denied.

By default, Client for NetWare Networks uses the credentials provided for preferred server authentication to access other NetWare servers. To see files on NetWare servers for which you have access, synchronize your credentials on all the NetWare servers, using the Novell SETPASS command at the command prompt.

Troubleshooting Windows 95 Using Novell NetWare Clients

This section describes some common problems that might occur when running a Novell-supplied client with Windows 95.

As a general troubleshooting step, make sure that the NETWARE.DRV file version 3.03.94.280 or later for VLM is present, plus version 2.02 or later for NETX. If necessary, restore this file from the Novell-supplied installation source.

- Check the version numbers of all Novell-supplied NetWare workstation shell components, including IPX, NETX, VLM, LSL, IPXODI, and the ODI driver files. Make sure the latest versions are being used.

To get the version number for the Novell-supplied software you are using, run *driver_name i* or *driver_name ?* at the command prompt. For example, type **netx i** to get the version number for the Novell-supplied NET*.COM or NET*.EXE file.

If you are not using the latest software, upgrade as described in [Obtaining Current Novell-Supplied Files](#).

- Check for multiple instances of the NetWare files, specifically the ODI driver and NET.CFG. If there are multiple instances, remove all but the most recent version.
- Verify that IPXODI is binding to the network adapter by running the NetWare NVER utility, using the same settings as NET.CFG and the same [**link driver ODI_driver**] name. If IPXODI is not bound to the network adapter, change the entries in NET.CFG to correct this problem.
- For a monolithic configuration, verify that the configuration does not use the **lo#** switch on IPX.COM or the **config option=** statement in SHELL.CFG.
- If the user is running a shared copy of Windows 95, verify that the home directory and shared Windows directory are the first two items in the path.

Setup requires Novell Workstation Shell Installation Program.

If, during installation, Setup fails to load Novell drivers and displays a message that it requires the Novell Workstation Shell Install Program for installing the VLM network client with Windows 95, follow the instructions presented in [VLM Technical Notes](#).

You cannot attach to the NetWare file server after installing Windows 95.

Verify the frame type being used by the NetWare server. If the NetWare server is using a different frame type from the one configured for the computer running Windows 95, the user cannot see the server. The Novell-supplied IPXODI protocol binds only to the first logical board, which is the first frame type in the **link driver ODI_driver** section in NET.CFG.

To correct this problem, manually edit NET.CFG so that the correct frame type is first in the **link driver ODI_driver** section.

You cannot see other computers running Windows 95 or NetWare server.

- Determine which frame type is used at your site, and then verify that the correct frame type you want to use on the network are listed in NET.CFG. The frame type that IPXODI will use must be first or must be set explicitly.
- Verify that the correct NET.CFG is being processed by LSL.COM. To do this, check the local drive for other NET.CFG files. There should be only one, and it should be in the same directory as the NetWare driver files. If you are loading these files from AUTOEXEC.BAT or another batch file, modify the batch file to change to this directory, run the necessary ODI drivers, and change back to the directory you want. This ensures that the current directory is the same as the location of the LSL.COM file when it is being loaded.
- Verify that NET.CFG contains the correct settings for the network adapter. If necessary, restore this file from a correct backup version, or edit it to include correct settings.
- Verify that you are running the latest version of the Novell-supplied ODI drivers and support files. Check with your network adapter manufacturer to determine whether a newer ODI driver is available.
- Verify that both client computers are running the same protocols. If the client computers are on

different sides of a router, make sure that an IPX/SPX-compatible protocol is being used on both computers.

You cannot access the login drive after installing Windows 95.

A common misconception is that users must log on to their NetWare server using the drive letter F. However, this is not true. For a client computer using the NETX workstation shell, the NetWare login drive is the next drive letter available after the **LastDrive=** statement in the Registry.

You can alter the **LastDrive=** statement to change the login drive, but you must leave enough drives before the **LastDrive=** that Windows 95 can use for its own connections.

Computer doesn't run after installing VLM support under Windows 95.

If a message says that the system cannot find a device file needed to run Windows, make sure that the VLM client has been installed using the Network option in Control Panel. This step ensures that the correct VLM information is placed in SYSTEM.INI. (The Novell-supplied installation program for VLM sets the path in SYSTEM.INI to the Windows SYSTEM directory rather than to VMM32.)

Introduction

This chapter provides details about installing and running Windows 95 on other networks. This chapter also includes information about host (that is, mainframe) connectivity for Windows 95.

Note Be sure to read the Windows 95 README.TXT and SETUP.TXT notes on networking. Also check the Microsoft WinNews forums on online services for specific information about your network and about particular network adapters.

- [Windows 95 on Other Networks: The Basics](#)
- [Windows 95 on Other Networks: The Issues](#)
- [Installing Support for Other Networks: An Overview](#)
 - [Installing Network Support During Windows 95 Setup](#)
 - [Installing Client for Microsoft Networks with Other Networks](#)
- [Using Real-Mode WinNet16 Drivers](#)
- [Artisoft LANtastic](#)
- [Banyan VINES](#)
- [DEC PATHWORKS](#)
- [IBM OS/2 LAN Server](#)
- [SunSoft PC-NFS](#)
- [Host Connectivity and Windows 95](#)
 - [Using DLC for Connectivity](#)
 - [Using Gateways for Connectivity](#)
 - [Using TCP/IP for Host Connectivity](#)
 - [Using Terminal Emulation Applications](#)
 - [Troubleshooting Connection Problems with Microsoft DLC](#)

Windows 95 on Other Networks: The Basics

Integrated networking support is a key feature of Windows 95. The new architecture that supports multiple network providers means that it's easier to install and manage support for a single network or multiple networks simultaneously using Windows 95 than in earlier versions of Windows. Windows 95 can support configuration on a single computer of as many 32-bit, protected-mode network clients as you want and one 16-bit, real-mode client using the network provider interface of Windows 95.

Windows 95 includes two protected-mode network clients (Client for Microsoft Networks and Client for NetWare Networks), plus built-in support for several types of 16-bit, real-mode network clients. In most cases, you also need to use supporting software from the network vendors in the following list:

- Artisoft® LANtastic® version 5.0 and later
- Banyan® VINES® version 5.52 and later
- DEC™ PATHWORKS™ version 5.0 and later
- IBM® OS/2® LAN Server
- Novell® NetWare® version 3.11 and later
- SunSoft™ PC-NFS® version 5.0 and later

Tip for Using Protected-Mode Network Clients from Other Vendors

The network provider interface defines a set of APIs used by Windows 95 to access the network for actions such as logging on to the server, browsing and connecting to servers, and so on. Microsoft has made this set of APIs widely available to network vendors so that they can develop new protected-mode network providers that are compatible with Windows 95.

For example, when a Banyan VINES 32-bit network provider becomes available, then Windows 95 can support Microsoft networks, Novell NetWare, and Banyan VINES connectivity at the same time through the Network Neighborhood.

Contact your network vendor to determine when protected-mode software for Windows 95 will be available for your network.

Multiple network support in Windows 95 consists of these components:

- Win32 WinNet API
- Multiple provider router and service provider interface
- Network providers, including the WinNet16 interface, as described in [Using Real-Mode WinNet16 Drivers](#)

For information about the system components that provide multiple network support, see [Windows 95 Network Architecture](#). For information about networking printing and support for printing when using a 16-bit network client, see [Printing and Fonts](#).

Windows 95 on Other Networks: The Issues

Although you can run any number of 32-bit network clients simultaneously, you can only run a single 16-bit, real-mode network client.

The network software should be installed and running on the workstation when you start Windows 95 Setup to install Windows 95, so that Setup can detect the network and install support for it automatically.

If your network vendor does not provide a 32-bit, protected-mode client that is compatible with Windows 95, and if you don't (or can't) run Client for Microsoft Networks in addition to your other network client, you cannot take advantage of the protected-mode networking features of Windows 95. For example:

- You won't gain the performance advantages of 32-bit, protected-mode network components, including Plug and Play networking support, long filenames, client-side caching, automatic reconnections, and other performance enhancements.
- You can't use the Windows 95 unified logon and user interface for navigating the network, or use the Windows 95 network management tools.
- You can't use user profiles for management of desktop configurations.

Specific issues for particular 16-bit network clients— including whether support for a particular network includes browsing in Network Neighborhood and whether you can also use a 32-bit, protected-mode client such as Client for Microsoft Networks simultaneously with that network — are presented in the section describing that network.

If support for your network's 16-bit client is not included with Windows 95, contact your network vendor to obtain a Windows 95 INF file.

Support for FTP NFS protocols can be installed by using the Network option in Control Panel. The required components (client, network provider, and so on) must be obtained from FTP.

Windows 95 on Other Networks

Installing Support for Other Networks: An Overview

This section describes how to install Windows 95 with network support from another vendor. For installation details related to your specific network, see the section for that network.

Installing Network Support During Windows 95 Setup

If you want to install Windows 95 on a computer that already has networking support from a network vendor other than Microsoft or Novell NetWare, you should be sure the network client from that vendor is installed correctly under MS-DOS, Windows version 3.1, or Windows for Workgroups.

The network software should be running when you start Windows 95 Setup. If Setup detects a network adapter but the computer is not running network software when you install Windows 95, then Setup installs Client for Microsoft Networks by default. Although in most cases the Network option in Control Panel provides the same controls for adding and removing networking components after Windows 95 Setup is complete, Microsoft recommends that you install networking support during Windows 95 Setup.

Note For computers running multiple network clients, Windows 95 Setup can install but cannot remove support for networks from other vendors.



To add a network client while running Windows 95 Setup

1. Make sure that the network client from your vendor is already installed under MS-DOS, Windows 3.1, or Windows for Workgroups. The network software should be running when you start Windows 95 Setup.
2. Start Windows 95 Setup as described in [Introduction to Windows 95 Setup](#), and choose the Custom setup type.
3. When the Network Configuration screen appears during Setup, your network client should appear in this list automatically, because Setup should detect the network you are running. If the list is correct, click OK to continue with Setup.

If you need to add the network client manually, click the Add button. Then double-click Client in the Select Network Component Type dialog box. In the Select Network Client dialog box, click the appropriate network vendor in the Manufacturers list, and click the name of the client in the Network Clients list. Then click OK.

Note Support for DEC PATHWORKS 5.x is installed as a protocol together with Client for Microsoft Networks, so DEC PATHWORKS does not appear in the Select Network Client dialog box. For information about installing support for this product, see [DEC PATHWORKS](#).

4. Because the network client keeps track of the network adapter and protocols, no protocols or adapters should be listed in the Network Configuration dialog box.
If you want to install Client for Microsoft Networks in addition to the network client from your vendor, follow the steps described in [Installing Client for Microsoft Networks with Other Networks](#). Otherwise, click the Next button and continue with Windows 95 Setup.
5. After Windows 95 is installed, check AUTOEXEC.BAT to make sure that all commands point to the correct directory for your network software.

On computers running multiple clients, Windows 95 Setup stores all real-mode networking components, including PROTOCOL.INI, in the Windows directory. On computers running a real-mode client as the primary network, the networking components are left in place. The settings in PROTOCOL.INI affect only real-mode NDIS drivers. Changing these values has no effect on protected-mode NDIS drivers. If you need to change settings in PROTOCOL.INI, use the Network option in Control Panel whenever possible. For information about PROTOCOL.INI entries, see [Windows 95 on Microsoft Networks](#).

All the Setup options for installing and configuring network support described in this chapter can be defined in custom setup scripts for automatic installation. To install Windows 95 using setup scripts, the Windows 95 source files must be placed on a server using Server-based Setup, and custom setup scripts must be created, as described in [Server-Based Setup for Windows 95](#). For information about installing support for another network client in custom setup scripts, see [MSBATCH.INF Parameters](#).

Installing Client for Microsoft Networks with Other Networks

If you want to install the 32-bit, protected-mode Client for Microsoft Networks in addition to a network client from another vendor, follow these steps. For information about configuring and using this network client, see [Windows 95 on Microsoft Networks](#).

Note Artisoft LANtastic cannot be used together with a 32-bit, protected-mode networking client such as Client for Microsoft Networks. This client can only be installed as the sole network client on the computer.



To install Client for Microsoft Networks after another network has been installed

1. Start Windows 95 Setup as described in [Introduction to Windows 95 Setup](#), and choose the Custom setup type.
– Or –
After Setup, double-click the Network option in Control Panel.
2. In the Network Configuration dialog box, click the Add button. In the Select Network Component Type dialog box, double-click Client.
3. In the Select Network Client dialog box, click Microsoft in the Manufacturers list, and click Client for Microsoft Networks in the Network Clients list. Click OK.
4. Usually hardware detection detects the correct network adapter and selects the corresponding driver. If you must add a network adapter, follow the steps in [Introduction to Windows 95 Networking](#).
5. In the Network Configuration dialog box, double-click the network adapter in the list of components. Verify the settings in the properties for the network adapter. Then click OK. For information, see [Network Technical Discussion](#). See also the documentation for your network adapter to verify its software settings.
Setup automatically installs a protected-mode version of any protocol that the installed network clients are using. If you need to install another protocol, follow the steps in [Introduction to Windows 95 Networking](#).
6. Click Next to continue with Setup.
– Or –
If you are adding support after Windows 95 has been installed, you must shut down and restart the computer.

Using Real-Mode WinNet16 Drivers

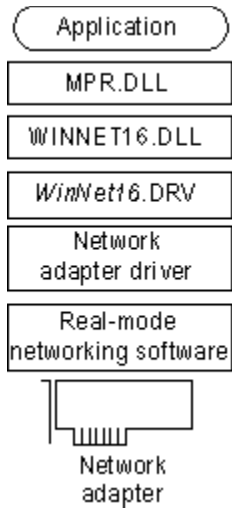

In addition to multiple 32-bit Windows 95 network providers, Windows 95 can also support a single 16-bit WinNet driver. This is the basic configuration that must be used for a network product that does not offer a 32-bit network provider.

If the 16-bit network provider from another network vendor does not provide a browsing scheme, Network Neighborhood will be empty in Windows 95, indicating that this is not a browsable network. You must use the Map Network Drive dialog box for network access. Also, notice that a drive connected through the Windows 95 user interface is accessible in all VMs. A connection made at a command prompt, however, will be available in that VM only and will not be available throughout the Windows 95 user interface.

The following list summarizes the components for the 16-bit, real-mode network drivers.

Component	Description
WINNET16.DLL	Provides a 32-bit to 16-bit thunk and translation between the 32-bit Windows 95 network provider interface and the 16-bit WinNet API.
<i>winnet16.DRV</i>	A 16-bit Windows 3.x network driver that provides a basic Map Network Drive dialog box.
<i>network.VXD</i> (or .386)	A Windows 3.x virtual device driver that allows virtualized access to the real-mode network software for all virtual machines (including the <i>winnet16.DRV</i>).
Real-mode network software	This can include proprietary network adapter drivers, protocol drivers, client (redirector), and network utilities loaded through CONFIG.SYS and AUTOEXEC.BAT (or other batch file).

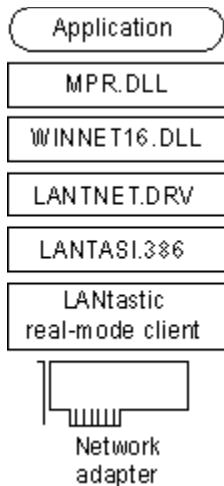

Windows 95 can be installed to run with Artisoft LANtastic version 5.x. or later client software. You must install Artisoft LANtastic by letting Windows 95 Setup detect this client while installing Windows 95. You cannot install support for this client after installation is complete.

LANtastic servers will not appear in Network Neighborhood. You can connect to servers at the command prompt.

Artisoft LANtastic can be configured only as the primary network. Additional 32-bit network providers, such as Client for Microsoft Networks or Client for NetWare Networks, are not possible in this case.



To set up Windows 95 with an Artisoft LANtastic real-mode network client

1. Make sure that the LANtastic server is not running. The LANtastic server cannot be run during Windows 95 Setup.
2. Make sure that the LANtastic client is already installed under MS-DOS, Windows 3.1, or Windows for Workgroups. The network software should be running when you start Windows 95 Setup. Then follow the steps in [Installing Support for Other Networks: An Overview](#). No other steps are required.



To connect to a LANtastic server when running Windows 95

- You must type the complete server name and share name in a Map Network Drive dialog box or at the MS-DOS Prompt.

The following table shows the entries required in configuration files when Artisoft LANtastic real-mode network support is installed with Windows 95.

Configuration file	Entries
autoexec.bat	@echo off path c:\windows;c:\windows\command;c:\dos; prompt \$p\$g rem lh c:\dos\share.exe call c:\lantasti\startnet.bat
config.sys	dos=high,umb device=c:\windows\himem.sys device=c:\windows\emm386.exe noems devicehigh=c:\windows\setver.exe rem - By Windows 95 Setup - stacks=9,256 files=100 rem - by Windows 95 Setup - buffers=30 fcbs =16,8
protocol.ini	[NDISHLP\$] drivername=ndishlp\$

```

bindings=
[PROTMAN$]
drivername=protman$

[DATA]
version=v4.00.166
netcards=

system.ini [LANTASTIC]
network_irq=15

```

Windows 95 on Other Networks

Banyan VINES

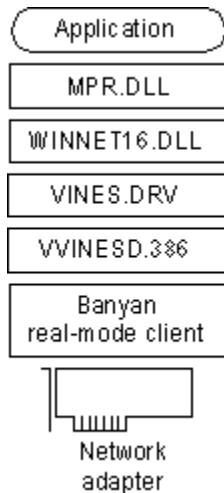

Windows 95 can be installed and run with Banyan VINES version 5.52(5) or later. Banyan VINES servers do not show up in Network Neighborhood. You can use the Map Network Drive dialog box in Windows 95 to connect to servers.

Banyan VINES as the primary network.

If real-mode support for Banyan is installed using a Banyan LAN driver, Windows 95 can support Banyan as the primary network. Banyan is also providing a 32-bit network client to be available after the release of Windows 95. Contact your vendor's sales support representative for information about the availability and features provided with this new client.

Banyan VINES as an additional 16-bit Windows 95 client.

If Banyan is installed with an NDIS 2 network adapter driver, then Banyan can be installed as an additional 16-bit network client, and you can install 32-bit, protected-mode clients such as Client for Microsoft Networks or Client for NetWare Networks.



To set up Windows 95 with Banyan VINES real-mode network client support

- If you are running on an Ethernet network, make sure that the Banyan VINES client is already installed under MS-DOS, Windows 3.1, or Windows for Workgroups. The network should be running when you start Windows 95 Setup. Then follow the steps in [Installing Support for Other Networks: An Overview](#). No other steps are required.

-Or -

- If you are running on a token-ring network, run Windows 95 Setup and choose the Custom setup type. In the Network Configuration dialog box, add Banyan Token Ring as the network client. Setup cannot detect Banyan as a token-ring network client.

Note If you are running Banyan VINES with monolithic drivers, you must use the PCCONFIG utility provided by Banyan to change Banyan drivers to NDIS drivers. Make sure that the section name matches the driver name.

The following table shows the entries required in configuration files when Banyan VINES real-mode network support is installed with Windows 95, depending on whether Banyan VINES is installed as the primary network only (connecting to a Banyan server) or is installed with Client for Microsoft Networks. These entries are for NDIS drivers.

Banyan VINES as Primary Network

Configuration file	Entries
autoexec.bat	cd \banfiles ban ndisban ; ndtokban for token ring redirall netbind arswait z:login c: cd\
config.sys	device=c:\banfiles\protman.dos /i:c:\banfiles device=c:\banfiles\ndis2driver eg: exp16.dos
protocol.ini	[PROTOCOL MANAGER] drivername=protman\$ [VINES_XIF] drivername=ndisban\$; ndtokban\$ for token ring ring bindings=MS\$EE16 [MS\$EE16] drivername=EXP16\$ interrupt=5 ioaddress=0x300 iochrdy=late

Banyan VINES with Client for Microsoft Networks

Configuration file	Entries
autoexec.bat	c:\windows\net initialize cd \banfiles ban ndisban ; ndtokban for token ring redirall c:\windows\net start arswait z:login c: cd\
config.sys	rem device=c:\banfiles\protman.dos /i:c:\banfiles rem device=c:\banfiles\ndis2driver eg: elnkii.dos
protocol.ini	[NDISBAN\$] ; NDTOKBAN\$ for token ring drivername=NDISBAN\$; NDTOKBAN\$ for token ring ring bindings=ELNKII\$ [NWLINK\$] drivername=NWLINK\$ frame_type=4 cachesize=0 bindings=ELNKII\$

```

[NETBEUI$]
drivename=NETBEUI$
lanabase=0
sessions=10
ncbs=12
bindings=ELNKII$

[ELNKII$]
drivename=ELNKII$
transceiver=external
interrupt=2
ioaddress=0x280
maxtransmits=12
datatransfer=pio_word
xmitbufs=2

[PROTMAN$]
priority=ndishlp$
drivename=protman$

[NDISHLP$]
drivename=ndishlp$
bindings=ELNKII$

```

Windows 95 on Other Networks

DEC PATHWORKS

Windows 95 can be installed and run with DEC PATHWORKS version 5.x. You must install Client for Microsoft Networks plus the DEC PATHWORKS protocol (there is no DEC PATHWORKS real-mode client). DEC PATHWORKS uses NDIS 2 network adapter drivers. Also, the Windows 95 AUTOEXEC.BAT file must contain a **startnet.bat** line to refer to the batch file used to start DEC PATHWORKS.

To install support for DEC PATHWORKS 4.1, you must install support for Windows for Workgroups 3.11 before running Windows 95 Setup. This software is available from the DECPI forum on CompuServe®. This is not necessary for installing support for DEC PATHWORKS 5.x.

If you are running DEC PATHWORKS 5.x, Windows 95 Setup detects the network. And, if you are using an NDIS, DLC, ODI, built-in DEPCA or Etherworks™ 3 data-link layer, Windows 95 Setup converts the configuration to NDIS drivers; Setup does not support X.25 or asynchronous data-link layers.

DEC is providing a 32-bit network client to be available after the release of Windows 95. Contact your vendor's sales support representative for information about the availability and features provided with this new client.

After Windows 95 is installed, you can use Network Neighborhood to browse DEC PATHWORKS servers running version 5.x. You can also use the standard Windows 95 methods for connecting to printers. Long filename support is possible only if you are connecting to a DEC PATHWORKS server version 5.0 or greater.

Also, if you are upgrading from Windows 3.1, you must install additional network components supplied by DEC; these are provided on the Windows 95 compact disc and installed automatically by Windows 95 Setup.



To set up Windows 95 with DEC PATHWORKS real-mode support

1. In Windows 95 Setup, choose the Custom setup type.
2. Install Client for Microsoft Networks, as described in [Installing Client for Microsoft Networks with Other Networks](#).
3. In the Network Configuration dialog box, click Add, and then double-click Protocol in the Select Network Component Type dialog box.
4. In the Select Network Protocol dialog box, click Digital Equipment (DEC) in the Manufacturers list,

and click a DEC PATHWORKS protocol in the Network Protocols list, depending on the server version number and whether you are running on a token-ring or Ethernet network. Click OK. Then click the Next button to continue with Setup.

Note For DEC PATHWORKS 5.x, you can use a DECnet™ protocol, or you can use NetBEUI or Microsoft TCP/IP.

The following table shows the entries required in configuration files when DEC PATHWORKS real-mode network support is installed with Windows 95.

Configuration file	Entries
autoexec.bat	<pre>c:\windows\net start @echo off prompt \$p\$g path c:\windows;c:\windows\command;c:\dos;c:\ set temp=c:\dos c:\pw\startnet.bat</pre>
config.sys	<pre>dos=high,umb device=c:\windows\himem.sys device=c:\windows\emm386.exe noems devicehigh=c:\windows\setver.exe rem - By Windows 95 Setup - stacks=9,256 files=100 rem - by Windows 95 Setup - buffers=30 fcbs =16,8</pre>
protocol.ini	<pre>[DLL\$MAC] drivename=DLL\$MAC lanabase=0 bindings=DEPCA\$ [NWLINK\$] drivename=NWLINK\$ frame_type=4 cachesize=0 bindings=DEPCA\$ [NETBEUI\$] drivename=NETBEUI\$ lanabase=1 sessions=10 ncbs=12 bindings=DEPCA\$ [DEPCA\$] drivename=DEPCA\$ maxmulticast=8 maxtransmits=16 adaptername=DE100 interrupt=5 ioaddress=0x200 ramaddress=0xd000 [PROTMAN\$] priority=ndishlp\$ drivename=protman\$ [NDISHLP\$] drivename=ndishlp\$</pre>

IBM OS/2 LAN Server

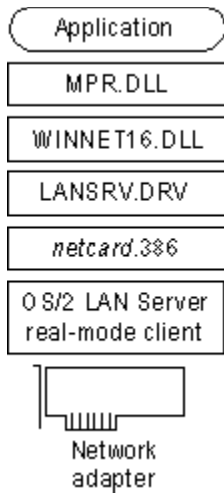

Windows 95 can be installed and run with these versions:

- IBM OS/2 LAN Server version 1.3 CSD
- IBM OS/2 LAN Server versions 1.2, 1.3, 2.0, and 4.0

Note If OS/2 LAN Server is installed using an OS/2 LAN Server LAN driver, Windows 95 can support OS/2 LAN Server as a primary network only. In this case, you cannot also install Client for Microsoft Networks as an additional network client.

Users can connect to servers using the Map Network Drive dialog box or command prompt. For OS/2 LAN Server servers to appear in Network Neighborhood for browsing, at least one computer in the LAN Server domain must be running File and Printer Sharing for Microsoft Networks and acting as the Browse Master (as described in [Logon, Browsing, and Resource Sharing](#)). Also, the workgroup name for the computer running File and Printer Sharing for Microsoft Networks must match the LAN Server domain name.

When support for OS/2 LAN Server is installed for use with Client for Microsoft Networks, aliasing is not supported.

If you are using custom setup scripts to install Windows 95 on multiple computers, make sure that at least one computer running Windows 95 in the LAN Server domain is already configured as the Browse Master. Also, make sure that the [Network] section of the custom setup script includes a correct value for **workgroup=LANServer_domain**.



To set up Windows 95 with IBM OS/2 LAN Server real-mode network client support

- Make sure that the OS/2 LAN Server client is already installed. The network should be running when you follow the steps in [Installing Support for Other Networks: An Overview](#). No other steps are required. However, you probably want to specify the LAN Server domain name as the workgroup name under Windows 95.

Windows 95 on Other Networks
SunSoft PC-NFS

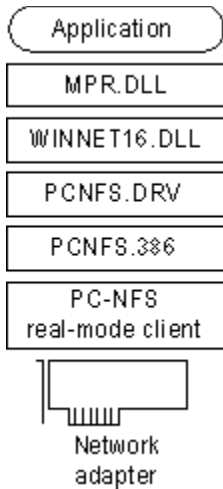

Windows 95 can be installed and run with SunSoft PC-NFS version 5.0. SunSoft servers will not appear in Network Neighborhood. You can use the Map Network Drive dialog box to connect to servers.

SunSoft PC-NFS as the primary network.

If SunSoft PC-NFS is installed using a SunSoft PC-NFS LAN driver, Windows 95 can support SunSoft PC-NFS as the primary network. Additional 32-bit network providers are not possible in this case.

SunSoft PC-NFS as an additional 16-bit Windows 95 client.

If SunSoft PC-NFS is installed with an NDIS 2 network adapter driver or with an ODI driver, then SunSoft PC-NFS can be installed as an additional 16-bit network client, and you can install 32-bit, protected-mode clients such as Client for Microsoft Networks or Client for NetWare Networks.

If you obtain supporting SunSoft PRO NFS components from the network vendor, you can use Microsoft TCP/IP with this client.



To set up Windows 95 with SunSoft PC-NFS real-mode network client support

- Make sure that the SunSoft PC-NFS client is already installed under MS-DOS, Windows 3.1, or Windows for Workgroups. The network should be running when you follow the steps in [Installing Support for Other Networks: An Overview](#). No other steps are required.

The following table shows the entries required in configuration files when SunSoft PC-NFS real-mode network support is installed with Windows 95, depending on whether PC-NFS is installed as the primary network only, or installed with Client for Microsoft Networks.

SunSoft PC-NFS as Primary Network

Configuration file	Entries
autoexec.bat	<pre>set tz=pst8pdt set path=c:\nfs;c:\dos;c:\net rem c:\net\net start c:\lanman\netbind set nfsdrive=c set nfspath=c:\nfs set tn_dir=c:\nfs\telnet c:\nfs\prt * c:\nfs\net init. c:\nfs\rtm</pre>
config.sys	<pre>rem device=c:\net\ifshlp.sys</pre>

```

lastdrive=z
device=c:\nfs\pcnfs.sys
device=c:\nfs\sockdrv.sys
device=c:\lanman\protman.sys /i:c:\lanman
device=c:\lanman\nfs-ndis.sys
device=c:\lanman\expl6.dos

```

SunSoft PC-NFS with Client for Microsoft Networks

Configuration file	Entries
autoexec.bat	<pre> c:\windows\net start set tz=pst8pdt set path=c:\nfs;c:\dos;c:\net set nfsdrive=c set nfspath=c:\nfs set tn_dir=c:\nfs\telnet c:\nfs\prt * c:\nfs\net init. c:\nfs\rtm </pre>
config.sys	<pre> rem device=c:\net\ifshlp.sys lastdrive=z </pre>

Windows 95 on Other Networks

Host Connectivity and Windows 95

Host connectivity in this section refers to connecting to legacy IBM mainframe computers, the mid-range IBM AS/400® computers, DEC VAX®/VMS, UNIX, and HP® 3000 computers. Host terminal emulation applications running in Windows 95 require network protocols to connect to their respective hosts.

The common network protocols used to support host connectivity include the following:

- **IPX/SPX.** The IPX/SPX-compatible transport provided with Windows 95 is compatible with Novell NetWare IPX/SPX, and can be installed to support host connectivity using terminal emulation programs and gateways supporting an IPX/SPX interface.
- **NetBEUI.** The NetBEUI protocol provided with Windows 95 supports a NetBIOS programming interface and conforms to the IBM NetBEUI specifications. It also includes performance enhancements related to NetBIOS 3.0. Microsoft NetBEUI can be installed on computers running Windows 95 to provide NetBIOS support for host connectivity using terminal emulation programs and gateways supporting a NetBIOS interface.
- **TCP/IP.** The TCP/IP protocol provided with Windows 95 is a complete implementation of the most common and accepted protocol available. It allows connectivity between interconnected networks with different operating systems and hardware architectures such as UNIX, IBM mainframes, and Microsoft networks. Usually, host connectivity with the TCP/IP protocol is provided using Telnet services such as TN3270 connecting to legacy mainframes, TN5250 connecting to an IBM AS/400, and using gateways supporting a TCP/IP interface. Microsoft TCP/IP supports the Windows Sockets 1.1 interface.
- **DLC.** Data Link Control (DLC) protocol is used primarily to access IBM mainframe computers. This protocol is not used for general networking with Windows 95. Host terminal emulation programs use this protocol directly to communicate with IBM mainframe computers.

For information about using Microsoft NetBEUI, the IPX/SPX-compatible protocol, and TCP/IP, see [Network Technical Discussion](#).

Windows 95 includes a real-mode version of the DLC protocol. This section discusses how to install the Microsoft DLC protocol for host connectivity, and how Windows 95 upgrades over existing DLC configurations. This section also provides tips for using terminal emulation applications and connectivity through gateways.

Using DLC for Connectivity

For direct connection and communication with a mainframe computer that uses DLC, the DLC protocol must be installed on the client computer that is running Windows 95. The Microsoft DLC protocol works with either token-ring or Ethernet network adapter drivers.

Microsoft DLC is also used to provide connectivity to local area printers connected directly to the network. For example, DLC can be used for printing to a printer such as a Hewlett-Packard HP® LaserJet® 4Si that uses an HP JetDirect® network adapter to connect directly to the network (rather than to a port on a print server). The DLC protocol must be installed and running on the print server for the printer. Computers sending print jobs to a print server for a DLC network printer do not need the DLC protocol — only the print server requires DLC. To take advantage of the DLC protocol device driver, you must create a network printer in the Printers folder.

The following sections describe how to install the Microsoft DLC protocol and how to configure it with Novell NetWare ODI drivers and IBM LanSupport.

Note Windows 95 contains the most up-to-date Microsoft DLC protocol. Make sure you are running the latest version, which is also available from Microsoft Download Service (MSDL) and CompuServe. For more information about MSDL, see [Windows 95 Resource Directory](#).

Installing and Configuring Real-Mode Microsoft DLC

Architecture for real-mode DLC with NDIS 2 network adapter drivers

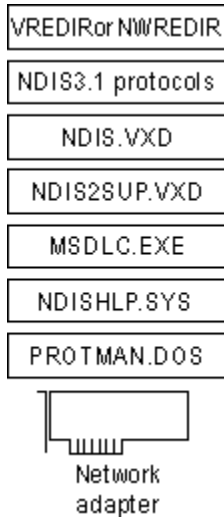

This section describes how to install the real-mode NDIS 2 Microsoft DLC protocol to bind with an NDIS 2 network adapter driver. This is an NDIS 2 protocol that, when installed, is bound to an NDIS 2 network adapter driver. The Windows 95 protected-mode protocols use the NDIS2SUP.VXD module to coexist with and run over the real-mode NDIS 2 network adapter drivers.

When you install Windows 95, Windows 95 Setup detects whether the computer already has the Microsoft DLC protocol installed; if so, Setup migrates the protocol and its settings to Windows 95. Otherwise, you can add Microsoft DLC as a protocol after Windows 95 is installed.

Note You must install the version of Microsoft DLC provided with Windows 95. You cannot use the Microsoft DLC INF file from Windows for Workgroups 3.x to install this protocol; Windows 95 uses a new INF file format.

You can also install Microsoft DLC using setup scripts, as described in [MSBATCH.INF Parameters](#).



To install the Microsoft DLC protocol on a computer running Windows 95

1. In the Network option in Control Panel, click Add.
2. In the Select Network Component Type dialog box, double-click Protocol.
3. In the Select Network Protocol dialog box, click Microsoft in the Manufacturers list, and then click Microsoft DLC in the Network Protocols list. Then click OK.
4. Shut down and restart the computer for the changes to take effect.
5. Make sure that there is only one **net start** entry in AUTOEXEC.BAT, because Setup automatically adds an entry to support DLC, even if such an entry already exists.

The properties in the following table are set by default for real-mode Microsoft DLC. You can use the Network option in Control Panel to change these default values, or to set values for other parameters that you might use, in the Advanced properties for Microsoft DLC protocol.

Value	Description
Saps	Indicates the number of SAPs that can be opened simultaneously. The range for SAPs is 1 to 255 inclusive. The default is 3. For a description of SAPs, see the <i>IBM Local Area Network</i>

Technical Reference. For more information about adjusting the SAPs value, see the entry for Stations.

- Stations** Indicates the number of link stations that can be opened simultaneously. The range for stations is 1 to 255 inclusive. The default is 20.
Each application requires a certain number of SAPs and stations. Because each SAP or station takes up memory, you should provide only enough for your application to run.
- Swap** Turns on address bit-swapping when it is enabled and Microsoft DLC is bound to an Ethernet driver. The default is 1 (enabled).
- Usedix** Sets the frame format. By default, this value is 0 (disabled), which is the correct value for 802.3 Ethernet format. Set this value to 1 for Ethernet DIX 2.0 (Ethertype 0x80D5) format. Ethernet DIX frames have an extra type-field.

The default values for Swap and Usedix are appropriate for most token-ring LAN environments. If the computer has an Ethernet adapter, then you should set the correct values for these parameters in the Advanced properties for Microsoft DLC. If you previously used the IBM DXME0MOD.SYS driver, use the following table to map the XMIT_SWAP parameter to set values for the two Microsoft DLC parameters.

DXME0MOD.SYS xmit_swap	Microsoft DLC parameters
0	swap=1 usedix=0
1	swap=1 usedix=1
2	swap=0 usedix=0
3	swap=0 usedix=1

The following example shows some typical settings in AUTOEXEC.BAT and PROTOCOL.INI for Microsoft DLC with an Intel EtherExpress PRO LAN NDIS 2 network adapter driver on an Ethernet network. Notice that the [Msdlc\$] section is added automatically by Windows 95 when the protocol is installed.

Sample Configuration File Settings for Microsoft DLC with NDIS 2 Adapters

Filename	Required settings
autoexec.bat	net init msdlc.exe net start
protocol.ini	[netbeui\$] DriverName=NETBEUI\$ Lanabase=0 sessions=10 ncbs=12 Bindings=EPRO\$ [nwlink\$] DriverName=nwlink\$ Frame_Type=4 cachesize=0 Bindings=EPRO\$ [epro\$] DriverName=EPRO\$ INTERRUPT=10

```

ioaddress=0x300
[protman$]
priority=ndishlp$
DriverName=protman$
[ndishlp$]
DriverName=ndishlp$
Bindings=EPRO$
[data]
version=v4.00.000
netcards=EPRO$, *PNP8132
[msdlc$]
DriverName=msdlc$
stations=20
saps=3
swap=0
usedix=1
Bindings=EPRO$

```

Windows 95 on Other Networks
Host Connectivity and Windows 95
Using DLC for Connectivity

Configuring Microsoft DLC with ODI Drivers

Architecture for real-mode DLC with ODI network adapter drivers



For computers that are running Microsoft DLC with ODI drivers using the Novell-supplied ODINSUP.EXE file, Windows 95 Setup installs over this configuration and leaves entries for ODINSUP and MSDLC in AUTOEXEC.BAT. Microsoft does not provide direct support for Microsoft DLC used with ODINSUP.EXE.

If you must run a real-mode network redirector or TSR (NETX.EXE, VLM.EXE, and so on), you need to configure Microsoft DLC by binding the Microsoft DLC protocol to an ODI network adapter driver, as shown in the illustration. Otherwise, install Microsoft DLC over NDIS 2 with the protected-mode Microsoft Client for NetWare Networks.

The following table shows settings used to configure Microsoft DLC with ODI drivers.

Configuration File Settings for Real-Mode Microsoft DLC over ODI Drivers

Filename	Required settings
autoexec.bat	<pre> ls1 ;Novell-supplied component mlid_driver.com ;Novell-supplied component odinhlp.exe ;Windows 95 component odinsup.exe ;Novell-supplied component msdlc.exe ;Windows 95 component </pre>

```

net start netbind ;Windows 95 component
net.cfg      Protocol ODINSUP
              Bind EPROODI
              BUFFERED
              Link Driver EPROODI
              Port 300
              Frame Ethernet_802.2
              Frame Ethernet_802.3
              Frame Ethernet_II
              Frame Ethernet_Snap
protocol.ini [protman$]
              priority=ndishlp$
              DriverName=protman$
              [ndishlp$]
              DriverName=ndishlp$
              Bindings=
              [data]
              version=v4.00.000
              netcards=
              [nwlink$]
              Frame_Type=4
              cachesize=0
              DriverName=nwlink$
              [msdlc$]
              DriverName=msdlc$
              xstations0=0
              xstations1=0
              stations=20
              saps=3
              xsaps0=1
              xsaps1=1
              swap=0
              usedix=1
              Bindings=EPROODI
              [EPROODI]
              Drivername=EPROODI
              INTERRUPT=10
              ioaddress=0x300

```

Windows 95 on Other Networks

Host Connectivity and Windows 95

Using DLC for Connectivity

Upgrading Existing IBM LanSupport Installations

If you are using DLC support supplied by IBM to connect to host computers, Windows 95 Setup can detect IBM DLC; it leaves the installation intact and configures Windows 95 to run over that configuration. Although support for IBM DLC can be installed using the Network option in Control Panel, the required components must be provided by your network vendor.

This section describes two typical IBM LanSupport configurations, using DXMC0MOD.SYS and DXME0MOD.SYS.

DXMC0MOD.SYS, the monolithic IBM DLC driver.

For this configuration, Windows 95 Setup does one of two things:

- If the computer is running NetWare, Setup keeps the DXMC0MOD.SYS driver and related settings, and installs the Generic ODI driver plus Microsoft Client for NetWare Networks, or keeps the real-mode client, as described in [Windows 95 on NetWare Networks](#).

- If the computer is running DXMC0MOD.SYS and no other networking components, Setup keeps the DXMC0MOD.SYS driver and does not install any Windows 95 networking components. The following shows a sample configuration for IBM DXMC0MOD.SYS with Microsoft Client for NetWare Networks.

Example of Configuration Settings for DXMC0MOD.SYS with ODI Drivers

Filename	Required settings
autoexec.bat	lsl ; Novell-supplied component lansup ; Novell-supplied component odihlp.exe ; Microsoft component
config.sys	device= <i>path</i> \dxmaood.sys ; IBM-supplied component device= <i>path</i> \dxmcomod.sys ; IBM-supplied component

DXME0MOD.SYS, the NDIS driver for IBM DLC.

For this configuration, Windows 95 Setup does one of three things:

Architecture for real-mode DLC with NDIS 2 network adapter and IBM LanSupport



- If the computer is running DXME0MOD.SYS and no other networking components, Setup keeps the DXME0MOD.SYS driver and does not install any Windows 95 networking components.
- If the computer is running DXME0MOD.SYS and Novell NetWare, Setup installs an NDIS network adapter driver plus Microsoft Client for NetWare Networks, and leaves the DXME0MOD.SYS driver intact.
- If the computer is running DXME0MOD.SYS with the IBM DOS LAN Requestor, Setup installs an NDIS 2 adapter driver, keeps the DXME0MOD.SYS driver, installs Client for Microsoft Networks, and removes the IBM DOS LAN Requestor redirector components.

The following shows a sample configuration for IBM DXME0MOD.SYS with Client for Microsoft Networks using an NDIS 2 adapter driver. The same basic kinds of settings are used for a computer running Microsoft Client for NetWare Networks with an NDIS 2 adapter driver.

Example of Settings for DXMCE0MOD.SYS with Client for Microsoft Networks

Filename	Required settings
autoexec.bat	net start netbind
config.sys	device=c:\windows\protman.dos /i:c:\windows device=c:\windows\epro.dos ;ndis2 driver device=c:\lsp\dxma0mod.sys ; IBM- supplied device=c:\lsp\dxme0mod.sys ,,3 ; IBM- supplied

protocol.ini

```
device=c:\windows\ndishlp.sys ;Windows
95
[protman$]
priority=ndishlp$
DriverName=protman$
[ndishlp$]
DriverName=ndishlp$
Bindings=EPRO$
[data]
version=v4.00.000
netcards=EPRO$,*pnp8132
[netbeui$]
DriverName=NETBEUI$
Lanabase=0
sessions=10
ncbs=12
Bindings=EPRO$
[nwlink$]
DriverName=nwlink$
Frame_Type=4
cachesize=0
Bindings=EPRO$
[EPRO$]
DriverName=EPRO$
INTERRUPT=10
ioaddress=0x300
[DXMAIDXCFG]
dxme0_nif=dxme0.nif
dxmj0mod_nif=dxmj0mod.nif
smcdosjp_nif=smcdosjp.nif
smcdosjp2_nif=smcdosjp.nif
smcdosat_nif=smcdosat.nif
smcdosat2_nif=smcdosat.nif
smcdosmc_nif=smcdosmc.nif
smcdosmc2_nif=smcdosmc.nif
[ETHERAND]
DriverName=DXME0$
Bindings=EPRO$
```

Using Gateways for Connectivity

When your network uses a gateway to communicate with a host computer, the client computer running Windows 95 communicates with the gateway computer just as it does with any other computer on the network. The gateway computer translates requests from the client into a form that can be understood by the host, then communicates with the host, and returns the information to the client. In this configuration, the client computer can connect to the gateway using any protocol that the gateway supports. The gateway uses some form of the DLC protocol to communicate with the host.

The following table shows commonly used gateways and the supported operating systems.

Gateway	Operating system
Microsoft SNA Server 2.0 and 2.1	Microsoft Windows NT 3.x
NetWare for SAA	Novell NetWare 3.x and 4.x
Wall Data Rumba Gateway	Microsoft Windows 3.x
Attachmate® Gateway 4.0 or higher	MS-DOS
DCA™ IRMALAN Gateway	MS-DOS
EICON	MS-DOS and Windows 3.x

Many of the gateways in the preceding table have MS-DOS versions, which run only under MS-DOS, not under Windows. Windows 95 does not support running the MS-DOS-based gateways in a VM. For information about support for a particular gateway under Windows 95, contact your gateway vendor.

Windows 95 on Other Networks

Host Connectivity and Windows 95

Using TCP/IP for Host Connectivity

Many utilities and terminal emulation programs from other vendors allow direct communication with a mainframe or host computer using a TCP/IP protocol stack. The protected-mode version of Microsoft TCP/IP included with Windows 95 relies on the Windows Sockets version 1.1 interface. Any terminal emulation program or utility that you use to connect to a mainframe or host computer over Microsoft TCP/IP must support Windows Sockets 1.1.

If you want to connect to a host computer using Telnet or TCP/IP and you are running an application that emulates an IBM 3270 or 5250, or a DEC VT xx computer terminal, you can use Microsoft TCP/IP. Before configuring Windows 95 for Microsoft TCP/IP, make sure that the emulation application supports Windows Sockets 1.1 as a TCP/IP interface option.

If your emulation software requires a TSR to communicate with another vendor's TCP/IP protocol stack, you must remove the TSR and reconfigure the emulation software for Windows Sockets in order to communicate using Microsoft TCP/IP in Windows 95. To determine the proper configuration with Windows Sockets, see the documentation for the emulation software. If the application does not support Windows Sockets 1.1, contact the application vendor to obtain a version that does; otherwise, do not use Microsoft TCP/IP.

Using Terminal Emulation Applications

Terminal emulation applications offer several different connectivity options for connecting to a host IBM AS/400, or DEC VAX computer. This section describes configuration and other issues related to using terminal emulation programs.

Connecting to a NetWare for SAA gateway.

For most emulation applications, configuring Windows 95 with the Microsoft IPX/SPX-compatible protocol enables connectivity to a NetWare for SAA gateway or to any gateway supporting IPX/SPX connectivity. If you are using a token-ring network with source routing, use the Network option in Control Panel to make sure that Microsoft IPX/SPX-compatible protocol appears in the list of network components. In Advanced properties for the protocol, set the Source Routing property to a 16-entry cache size.

If this configuration does not work well, configure Windows 95 to use a Novell-supplied real-mode NetWare client.

Connecting to a Windows NT SNA 2.0 or 2.1 server.

Windows 3.x client software supports connectivity to a Windows NT SNA 2.0 or 2.1 server. The Windows NT 32-bit client for SNA should not be used; it was designed to work only with client computers running Windows NT Workstation.

Connecting to an AS/400 with IBM PC Support software.

You can use Windows 95 to connect to an AS/400 using the IBM PC Support software. To do so, configure the PC Support application for Basic Mode; do not use Extended Mode. If the PC Support application was configured to connect using DLC, make sure that Microsoft DLC or IBM LanSupport is already installed on the computer.

You can also use Windows 95 to connect to an AS/400 using the NetWare for SAA gateway and the IBM PC Support application. Configure the PC Support application for Basic Mode; do not use Extended Mode. The IBM-supplied DOS16M.386 file is not compatible with Windows 95.

If Windows 95 is configured to use the IPX/SPX-compatible protocol, then you must create a WINSTART.BAT batch file in the Windows directory and add entries in this file to run PCSWIN.COM and STRNRTR.EXE (the Novell-compatible router). If you encounter problems using the protected-mode IPX/SPX-compatible transport with the Novell-compatible PC Support router, then configure Windows 95 to use the Novell-supplied NETX or VLM client with IPXODI, as described in [Windows 95 on NetWare Networks](#).

Connecting to a host computer using a coaxial adapter.

If you are using a coaxial connection with a coaxial adapter (CUT/DFT) supplied by IBM or another vendor, use the real-mode drivers provided with the adapter or emulation software for setting up hardware. No 32-bit drivers are available for connectivity with this type of adapter.

For information about using TCP/IP with IBM 3270 terminal emulation, see [Using TCP/IP for Host Connectivity](#).

Troubleshooting Connection Problems with Microsoft DLC

If you encounter problems using the real-mode Microsoft DLC protocol, check the following items:

- When adding the Microsoft DLC protocol, make sure that there is only one **net start** entry in AUTOEXEC.BAT. Setup adds an entry for Microsoft DLC, even if an entry already exists. Also, make sure that AUTOEXEC.BAT is configured properly, as described in [Installing and Configuring Real-Mode Microsoft DLC](#).
- Do not make direct entries or changes in PROTOCOL.INI for Microsoft DLC. Instead, make all changes in the Advanced properties for Microsoft DLC by using the Network option in Control Panel. If you make changes directly in PROTOCOL.INI, then the next time you change any values by using the Network option in Control Panel, all settings in PROTOCOL.INI for Microsoft DLC will be overwritten.
- Some terminal emulation applications use TSRs to communicate with the Microsoft DLC protocol. If your emulation application uses a TSR that runs from AUTOEXEC.BAT, then make sure that the entry for the TSR still exists (usually, the TSR entry occurs after the **msdlc** and **net start** lines). Windows 95 Setup removes or comments out many TSRs.
- The option named Set This Protocol To Be The Default Protocol in the Advanced properties for Microsoft DLC does not provide any functionality. This option should not be checked, because Microsoft DLC does not use LANA settings.
- Real-mode Microsoft DLC is an NDIS 2 protocol, so the network adapter must have an NDIS 2-compatible network adapter driver for use with Windows 95. Windows 95 includes many compatible drivers, but some Windows 95 drivers for certain PCI and PCMCIA cards do not have a corresponding NDIS 2 driver to allow loading real-mode Microsoft DLC.

Introduction

This chapter describes how to configure and use the Windows 95 logon process, network browsing, and peer resource sharing capabilities.

- Logon, Browsing, and Resource Sharing: The Basics
 - Unified System Logon Basics
 - Network Browsing Basics
 - Peer Resource Sharing Basics
- Logon, Browsing, and Resource Sharing: The Issues
- Overview of Logging on to Windows 95
- Configuring Network Logon
 - Configuring Logon for Client for Microsoft Networks
 - Configuring Logon for NetWare Networks
 - Setting Network Logon Options with System Policies
- Using Login Scripts
 - Using Login Scripts with Microsoft Networking
 - Using Login Scripts on NetWare Networks
- Technical Notes for the Logon Process
- Browsing Overview
 - Using Network Neighborhood
 - Browsing in Common Dialog Boxes
 - Connecting to Drive and Printer Resources
 - Browsing with the Net View Command
- Browsing on Microsoft Networks
 - Designating a Browse Master for Microsoft Networks
 - Building the Browse List for Microsoft Networks
 - Technical Notes on Browsing on Microsoft Networks
- Browsing on NetWare Networks
 - Using Network Neighborhood on NetWare Networks
 - Managing Connections with Client for NetWare Networks
 - Using Commands to Connect to NetWare Servers
 - Using Windows NT to Connect to NetWare Servers
- Overview of Peer Resource Sharing
 - Installing Peer Resource Sharing
 - Overview of Security for Peer Resource Sharing
- Using File and Printer Sharing for Microsoft Networks
- Using File and Printer Sharing for NetWare Networks
 - Sharing Resources on a NetWare Network
 - Using Bindery Emulation for Pass-Through Security
- Troubleshooting for Logon, Browsing, and Peer Resource Sharing

Logon, Browsing, and Resource Sharing

Logon, Browsing, and Resource Sharing: The Basics

This section summarizes key Windows 95 features that you can use to make network logon, resource browsing, and peer resource sharing easier and more secure for computers running Windows 95 on your network.

Unified System Logon Basics

Windows 95 offers a consistent user interface for logging on to and validating access to network resources. The first time the user logs on to Windows 95, logon dialog boxes appear for each network client on that computer and for Windows 95. If the user's password for Windows 95 or for another network is made the same as the password for the primary logon client, Windows 95 automatically logs the user on to Windows 95 and all networks using that password every time the user logs on. This means that, for users, network logon is simplified in that a single logon dialog box is presented each time the operating system starts. For network administrators, it means they can use existing user accounts to validate access to the network for users running Windows 95.

Note The Passwords option in Control Panel provides a way to synchronize logon passwords for different networks so they can be made the same if one is changed. For more information, see [Security](#).

When a user logs on to other networks with different passwords and chooses to save them, the passwords are stored in a password cache. The Windows 95 password unlocks this password cache. Thereafter, Windows 95 uses the passwords stored in the password cache to log a user on to other networks so no additional passwords need to be typed.

For NetWare networks, Windows 95 provides graphical logon to Novell NetWare versions 3.x, or 4.x if the network is configured for bindery emulation, plus a NetWare-compatible login script processor. This means that if you are using Microsoft Client for NetWare Networks, Windows 95 can process NetWare login scripts. If drive mappings and search drives are specified in a login script, then under Windows 95 the same user configuration is used for network connections as was specified under the previous operating system, with no administrative changes necessary.

For Microsoft networks, Windows 95 supports network logon using domain user accounts and login script processing (as supported by LAN Manager version 2.x and Windows NT).

Network Browsing Basics

Network Neighborhood is the central point for browsing in Windows 95. It offers the following benefits:

- Users can browse the network as easily as browsing the local hard disk.
- Users can create shortcuts to network resources on the desktop.
- Users can easily connect to network resources by clicking the Map Network Drive button that appears on most toolbars.
- Users can open files and complete other actions by using new common dialog boxes in applications. This new standard provides a consistent way to open or save files on both network and local drives.
- The network administrator can customize Network Neighborhood by using system policies, as described in [User Profiles and System Policies](#). A custom Network Neighborhood can include shortcuts to commonly used resources, including Dial-Up Networking resources.

In any situation in which you can type a path name for connecting to a server — such as in the Map Network Drive dialog box or at the command prompt — you can specify the server name with two backslashes (\\) if your network uses UNC path names. For example, to connect to the server CORP, volume DOCS, directory WORD, and subdirectory Q1, type the UNC name **\\corp\docs\word\q1**.

On NetWare networks, you can use the UNC name or standard NetWare syntax. For the previous example, you would type **corp/docs:word\q1**. (Notice that, in the NetWare environment, “/” and “\” are interchangeable.) However, Windows 95 does not support the NetWare 4.0 naming convention of **\\nwserver_sys\directory_path\filename.ext** where **\\nwserver_sys** is the name of the NetWare Directory Services (NDS) server volume object.

Peer Resource Sharing Basics

The two peer resource sharing services in Windows 95 — Microsoft File and Printer Sharing for NetWare Networks and File and Printer Sharing for Microsoft Networks — are 32-bit, protected-mode networking components that allow users to share directories, printers, and CD-ROM drives on computers running Windows 95. File and Printer Sharing services work with existing servers to add complementary peer resource sharing services.

For example, a NetWare network and its users will realize the following benefits by using File and Printer Sharing for NetWare Networks:

- Users can share files, printers, and CD-ROM drives without running two network clients. This saves memory, improves performance, and reduces the number of protocols running on your network. (Under Windows for Workgroups, Novell users had to also run a Microsoft network client to take advantage of peer resource sharing.)
- Security is user-based, not share-based. You can administer user accounts, passwords, and group lists in one place (on the NetWare server) because File and Printer Sharing for NetWare Networks uses the NetWare server's authentication database.
- Users running VLM or NETX clients can access shared resources on computers running Windows 95. The computer running Windows 95 looks as if it is just another NetWare server if it uses SAP Advertising, as [Using File and Printer Sharing for NetWare Networks](#). The computer providing File and Printer Sharing services can handle up to 250 concurrent connections.
- You can add secure storage space and printing to the network inexpensively, while using familiar NetWare tools to manage these resources. You can reduce the load and improve the performance of NetWare servers by moving selected shared resources to one or more computers running File and Printer Sharing services. This allows you to manage load balancing for users without adding a new NetWare server.
- You get a scalable, high-performance 32-bit peer server that uses multiple 32-bit threads, the new Windows 95 VFAT 32-bit file system, 32-bit NDIS drivers, 32-bit IPX/SPX-compatible protocol, and the burst-mode protocol.

Similar benefits are available when you use File and Printer Sharing for Microsoft Networks. You can also use either share-level security or, on a Windows NT network, user-level security to protect access to peer resources.

Logon, Browsing, and Resource Sharing: The Issues

This section summarizes the issues you need to consider when planning to use logon, browsing, and resource sharing features in Windows 95.

The network logon issues include the following:

- To use unified logon, a logon server (such as a Windows NT domain controller or a NetWare preferred server) must be available on the network and contain user account information for the user (unless, of course, the user is logging on as a guest).
- The Windows 95 logon processor can parse most statements in the NetWare login scripts. However, any statements loading TSRs must be removed from the scripts and loaded from AUTOEXEC.BAT. Because the Windows 95 logon processor operates in protected mode, it is not possible to load TSRs for global use from the login script. These TSRs should be loaded from AUTOEXEC.BAT before protected-mode operation begins, or using other methods described in [Using Login Scripts](#). In some cases, login scripts load backup agents as TSRs. In such cases, protected-mode equivalents built into Windows 95 can be used, making it unnecessary to load these TSRs.

The network browsing issues include the following:

- You can plan ahead to configure workgroups for effective browsing by using WRKGRP.INI to control the workgroups that people can choose. For information about configuring WRKGRP.INI, see [Custom, Automated, and Push Installations](#).
- If your enterprise network based on Microsoft networking is connected by a slow-link WAN and includes satellite offices with only Windows 95, then workstations in the satellites cannot browse the central corporate network. Consequently, they can connect to computers outside of their workgroups only by typing the computer name in a Map Network Drive dialog box. To provide full browsing capabilities, the satellite office must have a Windows NT server.
- You can use system policies, such as Hide Drives In My Computer or Hide Network Neighborhood, to limit or prevent browsing by users. For information, see [User Profiles and System Policies](#).

The resource sharing issues include the following:

- If you want to configure a computer to share its files or printers, the choice of which File and Printer Sharing service you install depends on whether users who will be browsing for shared resources are running Microsoft or NetWare network clients.
- If you want to use File and Printer Sharing for NetWare Networks, there must be a NetWare server available on the network. This peer resource sharing service uses only user-level security, not share-level security, so a NetWare server must be available to validate user accounts. Also, the NetWare server must include a Windows_Passthru account (with no password) in its user accounts database.
- If you plan to use File and Printer Sharing for Microsoft Networks with user-level security, then a Windows NT server or domain must be available to validate user accounts.
- If you plan to use Net Watcher to remotely monitor connections on a computer running File and Printer Sharing services, that computer must have the Microsoft Remote Registry service installed. This is also true if you want to use Registry Editor or System Policy Editor to change settings on a remote computer. For information, see [Remote Administration](#).
- If you are configuring a user's workstation to act as a peer server, you might also want to specify that this computer cannot run MS-DOS-based applications (which take exclusive control of the operating system, shutting down File and Printer Sharing services). To do this, you can set the system policy named Disable Single-Mode MS-DOS Applications.

Overview of Logging on to Windows 95

There can be two levels of system logon on Microsoft or NetWare networks:

- Log on to Windows 95 by using a user name and a password that is cached locally
- Log on to a NetWare network or a Windows NT domain for validation, [Overview of Logging on to Windows 95](#)

When other network vendors make 32-bit, protected-mode networking clients available, network logon will be automatically available for those networks because of the Windows 95 network provider interface, as described in [Windows 95 Network Architecture](#).

Windows 95 provides a single unified logon prompt. This prompt allows the user to log on to all networks and Windows 95 at the same time. The first time a user starts Windows 95, there are separate logon prompts for each network, plus one for Windows 95. If these passwords are made identical, the logon prompt for Windows 95 is not displayed again.

Logging on to Windows 95 unlocks the password cache file (.PWL) that caches encrypted passwords. This is the only logon prompt that appears if no other network clients are configured on that computer.



To log on to Windows 95 when no other network logon is configured

- When the Welcome to Windows dialog box appears after starting Windows 95 for the first time, specify the user name and password.

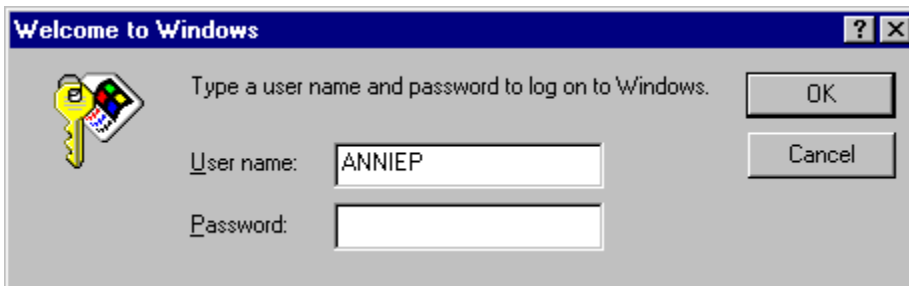

Windows 95 uses this logon information to identify the user and to find any user profile information. User profiles define user preferences, such as the fonts and colors used on the desktop, and access information for the user. (For more information, see [User Profiles and System Policies](#).)



To log on to Windows 95 on a Microsoft network

1. When the Enter Network Password dialog box appears after starting Windows 95 for the first time, specify the user name and password.

For network logon on a Microsoft network, type the name of the Windows NT domain, LAN Manager domain, or Windows NT computer that contains the related user account.

This dialog box appears for logging on to Windows NT networks

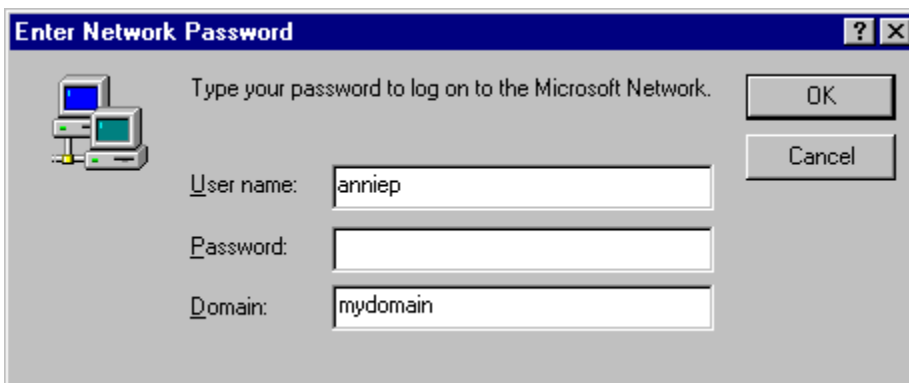

After the user name and password pair are validated by the network server, the user is allowed to use resources on the network. If the user is not validated, the user cannot gain access to network resources.

2. The first time Windows 95 starts, the Welcome to Windows dialog box appears, prompting you to type the user name and password defined for Windows 95.



To log on to Windows 95 on a NetWare network

1. To log on to a NetWare network, type the name of the NetWare server, which is the preferred server where the related user account is stored.

This dialog box appears for logging on to NetWare networks

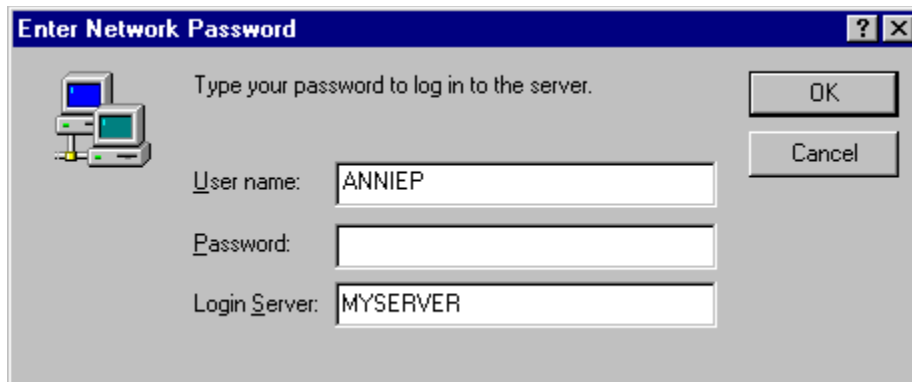

After the user name and password pair are validated by the NetWare server, the user is allowed to use resources on the network. If the user is not validated, the user will be prompted to type a password when connecting to a NetWare server during this work session.

2. The first time Windows 95 starts, the Welcome to Windows dialog box appears, prompting you to type the user name and password defined for Windows 95. Type this information and click OK.

The next time this computer is started, Windows 95 displays the name of the last user who logged on and the name of the domain or preferred server used for validation. If the same user is logging on again, only the password for the network server or domain needs to be entered. If another user is logging on, that user's unique user name and password must be entered. If the passwords are the same for the network and Windows 95, the second dialog box for logging on to Windows 95 does not appear again.

Configuring Network Logon

If you install either Client for Microsoft Networks or Client for NetWare Networks, you can configure a computer running Windows 95 to participate on a Windows NT or NetWare network.

Before you can use network logon on a computer running Windows 95, however, you must have a Windows NT domain controller or NetWare server on the network that contains user account information for the Windows 95 user. For more information about setting up permissions on a Windows NT or NetWare server, see the administrator's documentation for the server. For related information, see [Windows 95 on Microsoft Networks](#) and [Windows 95 on NetWare Networks](#).

The validation of a user's network password at system startup might not be required for accessing network resources later during that work session. However, system startup is the only time the login script can run, and it is the only time at which user profiles and system policies can be downloaded on the local computer. Therefore, proper network logon can be extremely important.

The following sections provide information about configuring network logon for computers on Windows NT and NetWare networks when using a 32-bit, protected-mode network client. You can also use system policies to control network logon options, as summarized at the end of this section. For information about enforcing logon password requirements, see [Security](#).

Tip Logon validation will control only user access to network resources, not access to running Windows 95. To require validation by a network logon server before allowing access to Windows 95, you must use system policies. For information, see [Setting Network Logon Options with System Policies](#).

Notice, however, that Windows 95 security cannot prevent a user from starting the computer by using Safe Mode or a floppy disk. If you require complete user validation before starting the computer in any way, use Windows NT as the sole operating system.

Logon, Browsing, and Resource Sharing

Configuring Network Logon

Configuring Logon for Client for Microsoft Networks

When the computer is configured to use Client for Microsoft Networks as the Primary Network Logon client, you can specify Microsoft Windows NT logon options in the Network option in Control Panel. This section describes how to configure these options.

Network logon automatically validates the user on the specified Windows NT domain during the process of logging on to Windows 95. If this option is not configured, the user cannot access most network resources. If this option is configured and the user does not provide a correct password, Windows 95 operation might seem normal, but the user will not have access to most network resources.

When you configure network logon options, you can specify whether you want to automatically establish a connection for each persistent connection to a network resource or verify whether to reestablish connections at system startup. You can also specify basic network logon options in custom setup scripts used to install Windows 95.

For complete procedures for configuring network logon and persistent connections for Client for Microsoft Networks, see [Windows 95 on Microsoft Networks](#). For information about defining network logon options in custom setup scripts, see [Custom, Automated, and Push Installations](#). For information about controlling network logon by using system policies, see [User Profiles and System Policies](#).

Configuring Logon for NetWare Networks

Each Windows 95 user must have an account on the NetWare server before being able to use its files, applications, or print queues. The NetWare server account contains user credentials (user names and passwords).

With Client for NetWare Networks, there is no real-mode logon before Windows 95 starts, just the single, unified logon prompt for Windows 95 that allows users to log on to the system and to all networks at the same time. The first time a user starts Windows 95, there are two separate logon prompts: one for Windows 95 and one for the NetWare preferred server. As long as the two passwords are the same, the second logon prompt for Windows 95 is not displayed again.

If the computer uses a Novell-supplied real-mode network client, network logon occurs in real mode, and uses all the NetWare configuration settings that were in place before Windows 95 was installed. There are no required changes.

To configure Client for NetWare Networks for network logon, you need to specify whether Client for NetWare Networks is the Primary Network Logon client, which means the following:

- System policies and user profiles are downloaded from NetWare servers, if you use these features.
- Users are prompted first to log on to a NetWare server for validation when Windows 95 starts (before being prompted to log on to any other networks).
- For this computer, the last login script runs from a NetWare server.

Tip When you start Windows 95 with Client for NetWare Networks configured as the Primary Network Logon client, Windows 95 automatically prompts you to provide logon information such as your password on the NetWare server.

You should never run the Novell-supplied LOGIN.EXE utility from a batch file or at the command prompt when you are using Client for NetWare Networks.

When you designate Client for NetWare Networks as the Primary Network Logon client, you must also specify a preferred NetWare server. Windows 95 uses the preferred server to validate user logon credentials and to find user profiles and system policy files. You can change the preferred NetWare server at any time.

The following procedure describes how to configure Client for NetWare Networks to log on to a NetWare network. If you use a NETX or VLM client, you can configure the setting for the preferred server using NET.CFG or using the **/ps** option in STARTNET.BAT, AUTOEXEC.BAT, or wherever you start NETX or VLM. For more information, consult your Novell-supplied documentation.



To use a NetWare server for network logon

1. In the Network option in Control Panel, select Client for NetWare Networks in the Primary Network Logon box.
2. Double-click Client for NetWare Networks in the list of installed components.
3. In the Client for NetWare Networks properties, set values for the configuration options, as described in the following table.

Property	Meaning
Preferred Server	Designates the name of the NetWare server that appears automatically in the network logon dialog box. Windows 95 obtains the NetWare login script from this server, unless you specify a different NetWare server in the Enter Network Password dialog box. This is also the server used to store user profiles and system policies, if these are used on your network. The Preferred Server setting is for the computer, not for individual users.
First Network	Specifies the first drive letter that you want assigned to

Drive	the first network connection.
Enable Logon Script Processing	Specifies that this computer will process NetWare login scripts when a user logs on to the network.

Client for NetWare Networks attempts to connect to the preferred server rather than the first server that responds to the Get Nearest Server broadcast. Client for NetWare Networks also attempts a number of server connections in case the client computer can't establish a connection with the preferred server.

Tip for Passwords on Windows 95 and NetWare Servers

After you log on to the network and you are validated by a NetWare server, Windows 95 automatically supplies the same user name and password for logging on to Windows 95. You are asked to supply your user name and password to log on to Windows 95 only if the user name or password is different from your NetWare user account. Therefore, you might want to keep your user name and password the same for both the Windows 95 and the NetWare networks.

Maintaining the same user name and password for both networks also makes it easier for network administrators to coordinate user accounts. For more information about passwords, including brief information on changing passwords on a NetWare server, see [Security](#).

With NETX and VLM clients, network logon occurs in real mode during system startup. Therefore, the logon prompt for Windows 95 always appears when these clients are used because the unified logon process is not available.

Logon, Browsing, and Resource Sharing
Configuring Network Logon

Setting Network Logon Options with System Policies

The network administrator can define system policies to enforce requirements for network logon. For example, you may want to make sure that users cannot access the local computer without network validation, or you may want to disable password caching.

For network logon in general, use these policies:

- Logon Banner, to specify a caption and other text, such as a legal notice, to be displayed before the logon dialog box appears.
- Require Validation By Network For Windows Access, to specify that each logon must be validated by a server before access to Windows is allowed.

For Microsoft Client for NetWare Networks, use this policy:

- Disable Automatic NetWare Login, to specify that when Windows 95 attempts to connect to a NetWare server, it does not automatically try to use the user's network logon name and password and the Windows logon password to make the connection.

For Client for Microsoft Networks, use these policies:

- Log On To Windows NT, to specify that this computer can participate in a Windows NT domain.
- Display Domain Logon Validation, to display a message when the domain controller has validated user logon.
- Disable Caching Of Domain Password, to specify that no caching is used for the network password. However, do not enable the Quick Logon feature when password caching has been disabled using system policies. The Quick Logon feature requires password caching to function properly.

For information about these policies and others that enforce password requirements, see [User Profiles and System Policies](#).

If a computer has the Microsoft Remote Registry agent installed, you can use System Policy Editor to remotely set network logon options on individual computers without using system policies. This is

useful in cases in which you have not previously enforced logon requirements using system policies but you want to make sure that network logon is configured properly on a specific computer.

Logon, Browsing, and Resource Sharing

Using Login Scripts

This section summarizes some information about using login scripts on Windows NT and NetWare networks. For details about using login scripts for push installation of Windows 95, see [Custom, Automated, and Push Installations](#).

Using Login Scripts with Microsoft Networking

This section summarizes how to use login scripts for Windows 95 on Windows NT networks.

Login scripts are batch files or executable files that run automatically when a user logs on to a computer running either Windows NT, Windows 95, or MS-DOS. Login scripts are often used to configure users' working environments by making network connections and starting applications.

There are several reasons that you might want to use login scripts:

- You want to manage part of the user environment (such as network connections) without managing or dictating the entire environment.
- You want to create common network connections for multiple users.
- You already have LAN Manager 2.x running on your network, and you want to continue to use login scripts you have created for that system.

To assign a user a login script, designate the path name of the login script file in the user's account on the server. Then, whenever that user logs on, the login script is downloaded and run. You can assign a different login script to each user or create login scripts for use by multiple users.

To create a batch-file login script, create an MS-DOS batch file. (For more information about creating batch files, see the *Windows NT Server System Guide* or your MS-DOS documentation.)

A login script is always downloaded from the server that validates a user's logon request. For users with accounts on Windows NT server domains that have one or more backup domain controllers and a primary domain controller, any one of the domain controllers can authorize a user's logon attempt. To ensure that login scripts always work for users, you should be sure that login scripts for all user accounts in a domain exist on every primary and backup domain controller in the domain. You can do this by using the Windows NT Replicator service, as described in the *Windows NT Server System Guide*.

Home directories on Windows NT networks are used to store user profiles and can also serve as private storage spaces for users. Typically, users also control access to their home directories and can restrict or grant access to other users.

To ensure access to user profiles, you should assign each user a home directory on a server. You can also assign users home directories on their own workstations (although this means that users won't have access to their user profiles from other computers); you might want to do this if you don't want the user to be able to access files and directories on the rest of the workstation.

Logon, Browsing, and Resource Sharing

Using Login Scripts

Using Login Scripts on NetWare Networks

On NetWare networks (version 3.x or using the bindery), the system login script named NET\$LOG.DAT is stored in the PUBLIC directory on the server. Individual user scripts are stored in their MAIL subdirectories. The network administrator can use SYSCON (or NWADMIN for VLM) to edit login scripts for any NetWare-compatible client running under Windows 95.

Login scripts are stored differently on NetWare 3.x servers (using bindery services) versus NetWare 4.x servers (using NDS). On a bindery server, the System login script is stored in the NET\$LOG.DAT file in the PUBLIC directory, and User login scripts are stored in the LOGIN file in MAIL subdirectories that correspond to the users' internal IDs. On an NDS server, the Container, Profile, and User login scripts are stored in the NDS database as properties of those objects.

The issues related to running login scripts depend on whether the computer is configured with Client for NetWare Networks or uses a Novell-supplied network client.

Logon, Browsing, and Resource Sharing

Using Login Scripts

Using Login Scripts on NetWare Networks

Running Login Scripts with Client for NetWare Networks

If the computer is running Client for NetWare Networks, the special Windows 95 login script processor runs the login script after the user completes entries in the network logon dialog box during system startup. Microsoft Client for NetWare Networks makes only bindery connections. When it connects to a NetWare 4.x server, the server must be running bindery emulation, so that the login scripts can be accessed in the same way as on a bindery server. If bindery-type login script files aren't available, you must use SYSCON from a NetWare 3.x server to connect to the NetWare 4.x server and create bindery-type System and User login scripts.

The Windows 95 login script processor runs NetWare 3.x system and user login scripts, using commands in these scripts, such as MAP and CAPTURE, to make global changes to the system environment. For example, a script might include SET statements or PATH statements to specify search drives.

The login script appears in a window if the user's login script contains the WRITE, DISPLAY, FDISPLAY, PAUSE, or WAIT commands.

The Login Script Processor window

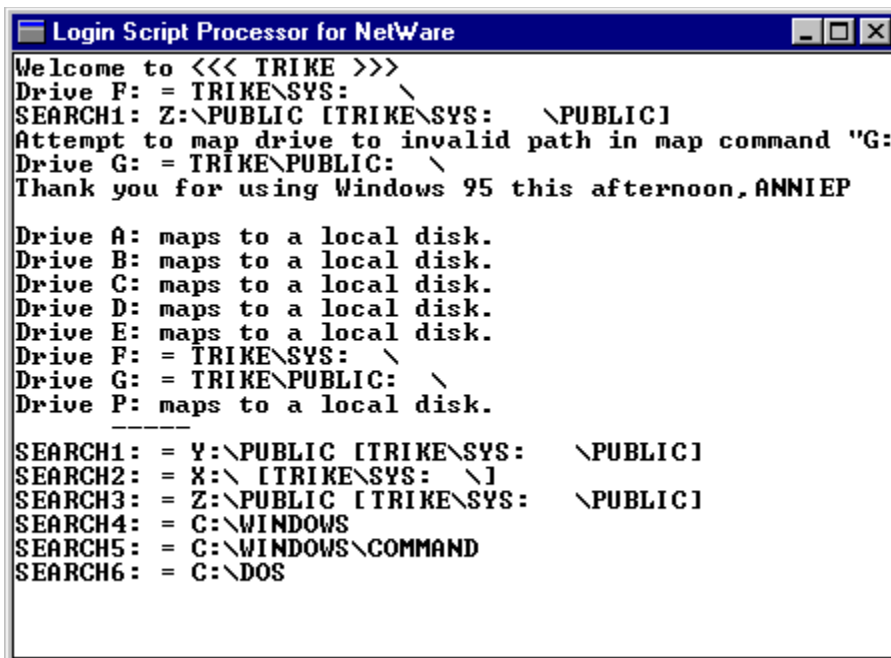

```

Login Script Processor for NetWare
Welcome to <<< TRIKE >>>
Drive F: = TRIKE\SYS: \
SEARCH1: Z:\PUBLIC [TRIKE\SYS: \PUBLIC]
Attempt to map drive to invalid path in map command "G:
Drive G: = TRIKE\PUBLIC: \
Thank you for using Windows 95 this afternoon, ANNIEP

Drive A: maps to a local disk.
Drive B: maps to a local disk.
Drive C: maps to a local disk.
Drive D: maps to a local disk.
Drive E: maps to a local disk.
Drive F: = TRIKE\SYS: \
Drive G: = TRIKE\PUBLIC: \
Drive P: maps to a local disk.

SEARCH1: = Y:\PUBLIC [TRIKE\SYS: \PUBLIC]
SEARCH2: = X:\ [TRIKE\SYS: \]
SEARCH3: = Z:\PUBLIC [TRIKE\SYS: \PUBLIC]
SEARCH4: = C:\WINDOWS
SEARCH5: = C:\WINDOWS\COMMAND
SEARCH6: = C:\DOS

```

Any NetWare or MS-DOS command (in conjunction with NetWare login script commands) can be used in a login script except those that load TSRs. The Windows 95 login script processor operates in protected-mode, so loading real-mode TSRs from a login script is not possible because login scripts are run after all real-mode actions are completed at system startup. Any TSR that is run from a login script is loaded in a single VM, which is subsequently shut down when login script processing is completed. In these cases, the login script processor displays an error message.

For loading components such as backup agents, protected-mode equivalents in Windows 95 can be used instead of running TSRs. If you need to run a TSR to support an application, use one of the options described in the following table.

Loading TSRs with Client for NetWare Networks

What the TSR must support **Where to load the TSR**

With NDIS 3.1 drivers:

All applications created for MS-DOS or Windows, without IPX/SPX support	AUTOEXEC.BAT
All Windows-based applications that require IPX/SPX support ¹	WINSTART.BAT in the Windows directory
Any MS-DOS-based application that requires IPX/SPX support ²	At the command prompt before running the application

With ODI drivers:

All applications created for MS-DOS or Windows with IPX/SPX support	After the entry that loads IPXODI in AUTOEXEC.BAT
---	---

- 1 The IPX/SPX-compatible protocol (NWLINK) is loaded after real mode is complete but before login scripts are processed, so this protocol is available for TSRs loaded from WINSTART.BAT.
- 2 The TSR must be loaded in each separate VM for each application that requires that TSR before the application is loaded. This can be done in a batch file used to run the application.

The network administrator might want to warn users that, in the following circumstances, the login script processor can display special windows and messages, and that this is not an error condition:

- When the login script runs, a message announces that the operating system is processing login scripts. The user can click a button to see details. However, if any statement in the script writes to the screen or if there is a PAUSE statement, the Logon Script Processor window appears and displays all subsequent statements as they run.
- If any *#DOS_command* statement is included in the script, a special VM is used to process the command. An MS-DOS Prompt window appears while the command is running and then closes automatically when the command is complete.

The following list presents some tips for testing and running login scripts with Client for NetWare Networks:

- In your testing laboratory, run the login script on a NETX computer and check the drive mappings and printer capture statements. Then run the script under Client for NetWare Networks and make sure the results are the same.
- Insert PAUSE statements frequently in the scripts you are testing so that you can study each screenful of information as it appears in the Logon Script Processor window.
- While testing scripts, check carefully for script errors that appear in the Logon Script Processor window.
- Insert PAUSE statements following any text that you want the user to read during system logon.

Note The Windows 95 login script processor can handle any documented NetWare login script commands. Any undocumented variations on NetWare commands might not be processed as legal statements.

You can make persistent connections (using the same drive letter each time) to NetWare volumes and directories by using the Windows 95 user interface. Using persistent connections eliminates the need for some NetWare MAP commands in login scripts. However, if persistent connections are made to a server, you should avoid using the ATTACH command in login scripts. For information about making persistent connections, see [Connecting to Drive and Printer Resources](#).

Client for NetWare Networks also differs from NETX and VLM in that it does not map the first network drive to the logon directory of the preferred server. All subsequent connections to NetWare servers must be made by using Windows 95 tools.

Logon, Browsing, and Resource Sharing

Using Login Scripts

Using Login Scripts on NetWare Networks

Running Login Scripts with Novell-Supplied Clients

If a computer is running the Novell-supplied NETX or VLM networking client, login scripts are processed as they were before Windows 95 was installed.

With NETX or VLM, login scripts are run during system startup after real mode at the command prompt before Windows 95 switches to protected mode. Therefore, all statements and TSRs will run as expected and be available globally for all applications created for Windows or MS-DOS.

Important Users running a Novell-supplied client should always log on to the NetWare server before running Windows 95. Otherwise, many operational problems will occur. For example, if a user instead logs on at command prompt while already running Windows 95, then all the drive mappings created by the login scripts will be local only to that VM.

Technical Notes for the Logon Process

The notes in this section provide a brief overview of the logon process in Windows 95.

If user profiles are enabled (using the Passwords option in Control Panel or by setting the related system policy), then a logon dialog box will always appear at system startup (even if the user's password is blank) because the user must be identified so the operating system can load the correct profile.

If user profiles are not enabled, then what happens in the logon process depends on the setting specified in the Primary Network Logon box in the Network option in Control Panel. If the Primary Network Logon setting is for a network provider such as Client for NetWare Networks or Client for Microsoft Networks, then an Enter Network Password dialog box will always appear at system startup if the network is active. These network providers cannot allow automatic logon without the user entering a password because the provider does not know which network password the user wants to use.

On a portable computer that has a network adapter that can be changed (for example, using the adapter on a docking station versus using a PCMCIA card), the logon dialog box appears when there is an active network. Only the Windows 95 system logon dialog box appears when the network is not active.

If the user selects Windows Logon as the value in the Primary Network Logon box in the Network option in Control Panel, then the Windows logon dialog box will appear first, followed by logon dialog boxes for any other network providers. In this case, if the Windows password and the passwords for any other network providers are all blank, then Windows 95 can attempt an automatic or "silent" logon (opening the user's password file with a blank password).

You might choose this configuration, for example, for peer servers that are physically secure from user access when you want such servers to be able to automatically recover from power outages or other failures without user intervention.

Note The administrator can use system policies to restrict users' access to the Passwords option in Control Panel or to require a minimum password length to prevent automatic logon using blank passwords.

Browsing Overview

Browsing in Windows 95 is the same for all network providers, whether the network is based on Windows NT Server, Novell NetWare, another network, or Windows 95 itself.

Users can browse network resources to connect to them. For example, users on NetWare networks can see NetWare servers and printers, plus computers running File and Printer Sharing for NetWare Networks. Users on Microsoft networks can find network resources by scrolling through a list of available workgroups, a list of available computers in a given workgroup, and a list of available resources on a given computer.

For technical details about network computing with Windows 95 on Microsoft and NetWare networks, see [Browsing on Microsoft Networks](#) and [Browsing on NetWare Networks](#).

Using Network Neighborhood

When you use Network Neighborhood, you can access shared resources on a server without having to map a network drive. Browsing and connecting to the resource consists of a single step: clicking an icon.

For information about what happens internally when Network Neighborhood is used to browse multiple networks, see the description of the Multiple Provider Router in [Windows 95 Network Architecture](#).

Using Workgroups in Windows 95

On Microsoft networks, computers are logically grouped in workgroups for convenient browsing of network resources. If share-level security is used, each computer in the workgroup maintains its own security system for validating local user logon and access to local resources.

NetWare networks do not use the workgroup concept, so computers running Windows 95 with VLM or NETX clients cannot be members of workgroups. However, computers running File and Printer Sharing for NetWare Networks with Workgroup Advertising enabled can appear in workgroups.

To set the workgroup for a computer, click the Identification tab in the Network option in Control Panel and type a name.

For more information about using Network Neighborhood, see online Help.



To browse a server quickly without mapping a drive

1. From the Start menu, click Run, and then type the server name. For example:

```
\\nwsrv1
```

2. To browse any shared directory in the window that appears, double-click its icon.
3. To browse this server's workgroup, press BACKSPACE. This is the equivalent of clicking the Up One Level button on the toolbar.



To create a shortcut on the desktop to a network resource

1. In Network Neighborhood, find the network resource for which you want to create a shortcut.
2. Using the right mouse button, drag the icon for that resource onto the desktop.
3. In the context menu, click Create Shortcut Here.
4. Double-click the shortcut icon to view the contents of the network directory in a new window. This shortcut is available every time you start Windows 95.

As the network administrator, you can use system policies to create a custom Network Neighborhood for individuals or multiple users. You can create shortcuts using UNC names for any network connections, including Dial-Up Networking connections, as part of the custom Network Neighborhood provided when using system policies. However, do not place directories in the custom Network Neighborhood. Windows 95 does not support this feature, and unpredictable results can occur. In System Policy Editor, enable the policy named Custom Network Neighborhood:

- Use Registry mode to enable this option on a local or a remote computer
- Use Policy mode to create or modify a policy file for one or more users

You can also set the following system policies to control users' access to built-in Windows 95 browsing features:

- Hide Network Neighborhood, to prevent access to Network Neighborhood
- No Entire Network In Network Neighborhood, to prevent access to the Entire Network icon in Network Neighborhood
- No Workgroup Contents In Network Neighborhood, to prevent workgroup contents from being

displayed in Network Neighborhood

For more information about specific policies and about using System Policy Editor, see [User Profiles and System Policies](#).

Browsing in Common Dialog Boxes

The new common dialog boxes (such as File Open and File Save) are standard in programs that use the Windows 95 user interface. They provide a consistent way to open or save files on network resources and local drives. Also, you can browse Network Neighborhood and you can perform most basic file management tasks by using a common dialog box.

Note Windows-based applications created for earlier versions of Windows do not use the new common dialog boxes.

In Windows 95, you can create new directories (also called folders) when you are saving a document (unlike Windows 3.1 in which you had to start File Manager or exit to the MS-DOS command prompt). This means that you can also create a new directory on a shared network resource when saving documents, as shown in the following procedure. This procedure can be used in any application that uses the Windows 95 common dialog boxes.



To create a new directory on the network while saving a file

1. In the File menu, click Save As.
2. In the Save In list, select a network location. If you need to, you can click Network Neighborhood in this list to browse for the computer on which you want to save the file.

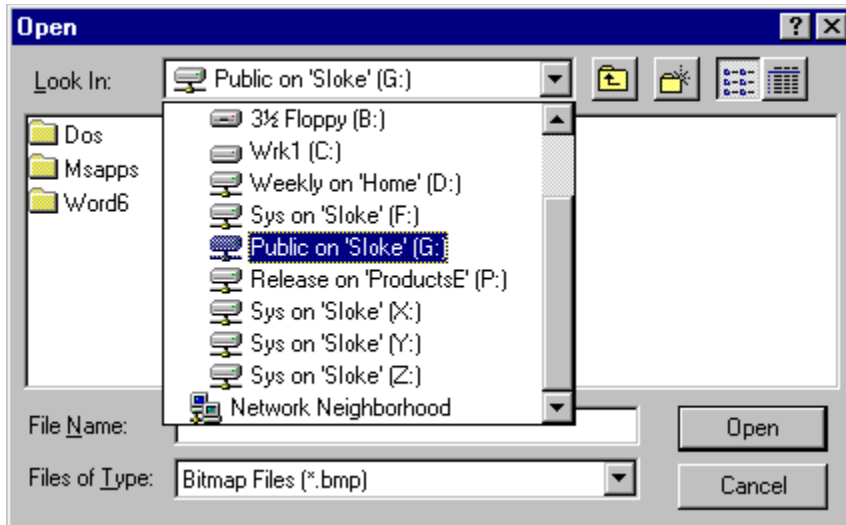

3. Click the Create New Folder icon, and type text for the new directory label.
4. In the File Name box, type a name for the file, and then click Save.

Connecting to Drive and Printer Resources

The toolbar is available in every window and includes the Map Network Drive button. If you click this button, the Map Network Drive dialog box appears. In this dialog box, you can type the name of a network server and shared directory using the UNC name. For example, the UNC name for the server CORP and the shared directory DOCS is \\CORP\DOCS. On NetWare networks, you can also type any remote computer name understood by the network (for example, TRIKE/SYS:public).

You can make a persistent connection to any drive (that is, you can store its name and automatically reconnect to it at startup) by clicking the Reconnect At Logon check box in the Map Network Drive dialog box. Persistent connections are restored to the same drive letters each time Windows 95 is started.

You can display this dialog box by right-clicking the Network Neighborhood icon.

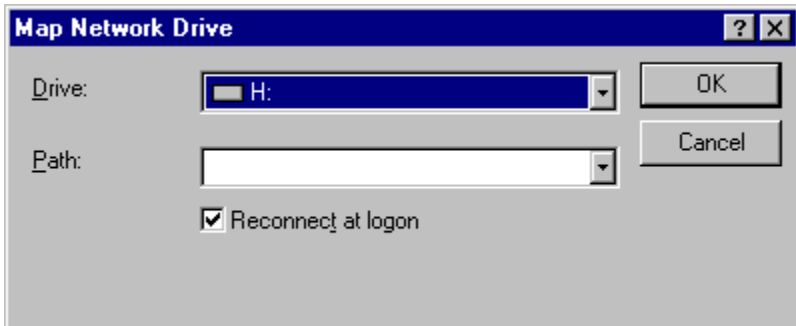

When installing a new printer, you can specify a shared printer resource by using the UNC name or the Point and Print method. For example, for the shared printer named HP_III on the server CORP, the name UNC is \\CORP\HP_III. For more information about Point and Print, see [Printing and Fonts](#).

Browsing with the Net View Command

Browsing network resources at the command prompt is handled by the real-mode networking components. You can use the **net view** command to perform most of the same browsing actions as Network Neighborhood or Windows Explorer, except that it cannot provide a list of workgroups.

For specific notes about using the **net** commands on NetWare networks, see [Browsing on NetWare Networks](#).



To display a list of computers with shared resources in a workgroup

- At the command prompt, type the following and then press ENTER.

net view [*\\computername*]

– Or –

net view [*/workgroup:workgroupname*]

Where *computername* is the name of the computer with shared resources you want to view; */workgroup* specifies that you want to view the names of the computers that share resources in another workgroup; and *workgroupname* is the name of the workgroup that has computer names you want to view.

Browsing on Microsoft Networks

The Windows 95 browsing scheme for Microsoft networks is based on the scheme currently used for Windows NT and Windows for Workgroups. The Windows 95 browse service attempts to minimize the network traffic related to browsing activity, while also providing an implementation that scales well to support both small and large networks.

This section describes how the browse service designates browse servers and maintains the browse list.

Designating a Browse Master for Microsoft Networks

The Windows 95 browse service uses the concept of a master browse server and a backup browse server to maintain the browse list. There is only one master browse server for a given Windows 95 workgroup for each protocol used in the workgroup; however, there can be one or more backup browse servers for each protocol for a given workgroup.

The master browse server is responsible for maintaining the master list of workgroups, domains, and computers in a given workgroup. To minimize the network traffic that the master browse server can be subjected to when handling browsing services, backup browse servers can be designated in a workgroup to help off-load some query requests. Usually, there is one browse server for every 15 computers assigned to a given workgroup.

When Windows 95 is started on a computer, the computer first checks to see if a master browse server is already present for the given workgroup. If a master browse server does not exist, an election creates a master browse server for the workgroup.

If a master browse server already exists, Windows 95 checks the number of computers in the workgroup, and the number of browse servers present. If the number of computers in the workgroup exceeds the defined ratio of browse servers to computers in a workgroup, an additional computer in the workgroup might become a backup browse server.

The Browse Master parameter in the Advanced properties for File and Printer Sharing for Microsoft Networks provides a mechanism for controlling which computers can become browse servers in a workgroup. If this parameter is set to Automatic, the master browse server can designate that computer as a backup browse server when needed, or that computer can be elected as master browse server. For information about configuring this parameter, see [Using File and Printer Sharing for Microsoft Networks](#).

Tip for Using the Net View Command to Check the Browse Server

The **net view** command is a valuable troubleshooting tool if you suspect the browse list maintained by a browse server is incomplete or inaccurate. You can use **net view /workgroup:** *workgroupname* at the command prompt to get the list of known computers directly from the master browse server. The request is not handled by a backup browse server.

If the list of computers returned by a master browse server is inaccurate, you could reset this computer by quitting Windows 95. Another computer will then be promoted to master browse server for the workgroup.

Building the Browse List for Microsoft Networks

In Windows 95, the browse service maintains an up-to-date list of domains, workgroups, and computers, and provides this list to applications when requested. The user sees the list in the following types of circumstances:

- If a user requests a list of computers in a workgroup, the browse service on the local computer randomly chooses one of the browse servers it is aware of and sends the request.
- If a user selects a workgroup to which the computer does not belong, Windows 95 requests a list of computers defined in the selected workgroup from a browse server in the selected workgroup.

The selected browse server also sends a list of the other workgroups it knows about that are defined on the network, along with a list of computers in the workgroup to which the user belongs.

The browse list is displayed in the Map Network Drive and Connect Network Printer dialog boxes, or anywhere that Windows 95 presents lists of resources that can be browsed. The browse list can also be displayed by using the **net view** command. The list can contain the names of domains, workgroups, and computers running the File and Printer Sharing service, including the following:

- Computers running Windows 95, Windows for Workgroups, and Windows NT Workstation
- Windows NT Server domains and servers
- Workgroups defined in Windows 95, Windows for Workgroups, and Windows NT
- Workgroup Add-on for MS-DOS peer servers
- LAN Manager 2.x domains and servers

Logon, Browsing, and Resource Sharing

Browsing on Microsoft Networks

Building the Browse List for Microsoft Networks

Adding New Computers to the Browse List

When a computer running Windows 95 is started on the network, it announces itself to the master browse server for its workgroup, and the master browse server adds that computer to the list of available computers in the workgroup. The master browse server then notifies backup browse servers that a change to the browse list is available. The backup browse servers then request the new information to update their local browse lists. It might take as long as 15 minutes before a backup browse server receives an updated browse list, and new computers on the network do not show up in a user's request for a browse list until then.

Logon, Browsing, and Resource Sharing

Browsing on Microsoft Networks

Building the Browse List for Microsoft Networks

Removing Computers from the Browse List

When a user shuts down a computer properly, the operating system informs the master browse server that it is shutting down. The master browse server then notifies backup browse servers that a change to the browse list is available. The backup browse servers then request the changes to the browse list.

If a user turns off the computer without shutting down, the computer does not get a chance to send the message to the master browse server. In this case, the computer name might continue to appear in the browse list until the name entry times out, which can take up to 45 minutes.

Technical Notes on Browsing on Microsoft Networks

This section presents some brief notes related to browsing on Microsoft networks.

- The Windows 95 browser has been updated to support browsing across TCP/IP subnetworks. To take advantage of this, the network must use a WINS server or you must use #DOM entries in LMHOSTS files for name resolution.
- Microsoft LAN Manager-compatible networks such as Microsoft LAN Manager for UNIX® and IBM® LAN Server support browsing of servers and shared directories using the Windows 95 user interface or **net view**.
- DEC™ PATHWORKS™ is an example of a Microsoft LAN Manager-compatible network that does not support browsing. AT&T® StarLAN is an example of a Microsoft Network-compatible network that is not based on Microsoft LAN Manager and that does not support remote browsing of servers and shared directories. These servers do not appear in Network Neighborhood; with Windows 95, however, users can still access the servers and shared directories through a network connection dialog box.
- When a known slow network connection is used (for example, the remote access driver), Windows 95 is automatically configured not to designate that computer to be a browse server for the network connection. The **SlowLanas** parameter in the Registry identifies the network LANA numbers for which the local computer will not serve as a master browse server. However, the user can still request a list of available workgroups and computers on the network across the slow network connection.

Logon, Browsing, and Resource Sharing

Browsing on NetWare Networks

The Windows 95 user interface includes support for browsing and connecting to network resources on Novell NetWare and other networks. Except for workgroups, this support is the same whether you use Client for NetWare Networks or the Novell-supplied NETX or VLM client. After you connect to a NetWare volume or a computer running File and Printer Sharing for NetWare Networks, you can drag and drop directories and files to move and copy them between your computer and the NetWare server.

For information about printer connections, see [Printing and Fonts](#).

Using Network Neighborhood on NetWare Networks

Network Neighborhood is the primary way you can browse the network. When you open Network Neighborhood on a computer running a NetWare-compatible networking client, all the NetWare bindery-based servers your computer is connected to are displayed. All computers running File and Printer Sharing for NetWare Networks that use Workgroup Advertising also appear in Network Neighborhood.

Clicking the Entire Network icon displays a list of all NetWare servers on the network. This list also contains a list of workgroups that include computers running File and Printer Sharing for NetWare Networks. You can view the contents of any server without having to map a network drive.

If your computer has both Client for Microsoft Networks and Client for NetWare Networks installed, then you will also see a list of computers running Windows for Workgroups, Windows 95, and Windows NT. The list of NetWare servers is at the beginning of the list of workgroups or domains in the Entire Network window.

In both the Network Neighborhood and Entire Network views, you can open a server to access its contents without having to map a network drive. You will be asked for security information, if necessary, and you can choose to save your password in the password cache so that you will not have to type it again.

If the computer is running Client for NetWare Networks, drive mappings are limited to the available drive letters. However, Windows 95 supports unlimited UNC connections. (If the computer is running NETX or VLM, it is limited to only eight server connections.)



To connect to a NetWare server in Network Neighborhood

1. In Network Neighborhood, right-click a NetWare server.
2. In the context menu, click Attach As. Then type a user name and password, and click OK.

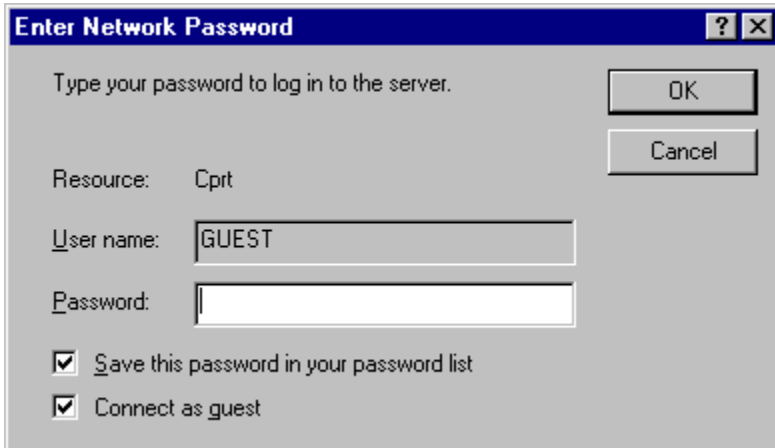

3. If you want to map a directory on this server, double-click the server icon. Right-click the directory you want to map, and click Map Network Drive in the context menu. Fill in the Map Network Drive dialog box, and click OK.

Tip You can also create a shortcut to frequently used resources. For information, see [Using Network Neighborhood](#). When you double-click a shortcut, you have to supply only a password to connect to it.

The toolbar on every window includes the Map Network Drive button, which you can use to specify the name of a NetWare server and volume (or directory) that you want to map to a drive letter.



To connect to a directory as the root of the drive

1. In Network Neighborhood, right-click a directory on a NetWare server. In the context menu, click Map Network Drive.
2. In the Map Network Drive dialog box, make sure Connect As Root Of The Drive is checked, and then click OK.

With this option enabled, if you switch to this mapped directory in a VM window, you will see the prompt as *drive:\>* not *drive:\directory>*). You cannot go further up the directory tree from the command prompt.

The context menu for a NetWare server shows everything you can do with the related server, volume, or directory. To view the context menu, in Network Neighborhood, right-click a NetWare server.

The following table describes the commands available on the context menu.

Command	Description
Open	Connects to that server.
Explore	Shows the resources available on that server without making a connection.
Who Am I	Specifies whether the user is logged on or attached to the server; if a user is logged on and the computer is attached, specifies that user's name.
Log Out	Logs the user off the server.
Attach As	Presents a dialog box for typing a password to log on to the server. This dialog box allows the user to connect to the server by using a different user name from the one used to log on to the network.
Map Network Drive	Presents a dialog box for mapping a network drive to a drive letter.
Create Shortcut	Creates a shortcut on the desktop for the selected server.
Properties	Shows the properties for the server. Notice that listing the properties of a NetWare server creates an attachment without logging on, thereby using up one of the allowable connections.

If a computer running File and Printer Sharing for NetWare Networks has been configured to allow remote administration, and if you have the authority to administer that server, you can use the administration options in the computer's properties. To do this, in Network Neighborhood, right-click the computer's icon. In the context menu, click Properties, and then click the Tools tab. Use the buttons to run Net Watcher or System Monitor, or to administer the file system.



For more information about preparing computers for remote administration under Windows 95, and about using Net Watcher and other tools, see [Remote Administration](#).

Logon, Browsing, and Resource Sharing

Browsing on NetWare Networks

Managing Connections with Client for NetWare Networks

Client for NetWare Networks is different from NETX and VLM in that it does not map the first network drive to the logon directory of the preferred server. All subsequent connections to NetWare servers must be made in the Windows 95 user interface.

With Client for NetWare Networks, you can manage connections to the NetWare network by using Network Neighborhood and common network-connection dialog boxes such as the Open and Save dialog boxes. (These are the same techniques used for Microsoft networks.)

With Client for NetWare Networks, you can define persistent connections (which use the same drive letter each time the computer starts) to NetWare volumes and directories. Using persistent connections eliminates the need for NetWare MAP commands in login scripts; however, you can still use MAP, ATTACH, and other commands at the command prompt or in login scripts, as described in the following section.

Using Commands to Connect to NetWare Servers

If you are running Client for NetWare Networks, all NetWare commands run in the same way as they do for a Novell-supplied networking client. The ATTACH and SLIST commands provided with Windows 95 use the same syntax and work in exactly the same way as the counterparts provided by Novell.

The following should be noted about certain Novell-supplied commands:

- For the ATTACH command, configure the networking client to use SAP advertising.
- You should not use the LOGIN utility to create an attachment to a computer running File and Printer Sharing for NetWare Networks. Use the ATTACH command instead.
- For the MAP command, drive mappings in Windows 95 are global to all sessions.

You can also use the Microsoft networking **net** commands at the command prompt or in login scripts to manage connections on NetWare networks. For example, the **net use** command can be used to do the following:

- Perform the same functions as the NetWare ATTACH and MAP commands.
- Supply similar functionality to the CAPTURE utility for printing when programs require printing to a specific port.

You can use the Windows 95 **net view** command to perform the same function as the NETX SLIST or VLM NLIST SERVER commands.

The following brief procedures show built-in Windows 95 commands that can be used at the command prompt or in scripts to manage resource connections.



To view NetWare servers

- At the command prompt or in a login script, type **net view**

For example:

```
D:\WIN\COMMAND>net view
NetWare Servers
```

```
-----
\\386
\\TRIKE
\\WRK
```



To view volumes on a server

- At the command prompt or in a login script, type **net view \\servername**

For example:

```
D:\WIN\COMMAND>net view \\trike
```

```
Shared resources at \\trike
Sharename      Type           Comment
-----
SYS            Disk
PUBLIC        Disk
```

The **net view** command creates an attachment without logging on. Viewing a NetWare server or a computer running File and Printer Sharing for NetWare Networks does not show print queues. However, viewing a computer running File and Printer Sharing for Microsoft Networks shows both shared directories and shared printers.

Use the **/network** parameter to specify the volumes on the particular network you want to view. For example:

```
net view \\nwserver_name /network:nw
```



To create a drive connection

- At the command prompt or in a login script, type **net use drive: \\servername\volume**

For example:

```
D:\WIN\COMMAND>net use l: \\trike\sys
The password is invalid for \\TRIKE\SYS.
Enter user name for server TRIKE:joed
Enter the password for user JoeD on server TRIKE:
```

The **net use** command is equivalent to MAP *drive:=servername\volume:* and it maps only to the root of the volume.

Tip To use the next available drive letter when connecting to the volume, replace the drive letter with an asterisk (*).

By typing the **net use** command without parameters, you can list the current network connections. For example:

Status	Local	Remote	Network
---	----	-----	-----
-	E:	\\NW4\SYS	NetWare
OK	F:	\\WINDOWS\DROOT	Microsoft
-	H:	\\NETWARE40\THOR\APPS	NetWare

To delete a drive connection

- At the command prompt or in a login script, type **net use drive: /d**

For example:

```
D:\WIN\COMMAND>net use l: /d
```

The **/d** switch and the NetWare command MAP DEL *drive* are equivalent.

To create a print connection

- At the command prompt or in a login script, type **net use port: \\servername\queue name**

For example:

```
D:\WIN\COMMAND>net use lpt3: \\trike\pscript1
```

This is equivalent to CAPTURE I=*port* S=*servername* Q=*queue name*.

To delete a print connection

- At the command prompt or in a login script, type **net use port: /d**

For example:

```
D:\WIN\COMMAND>net use lpt3: /d
```

This is equivalent to ENDCAP L=*port#*.

The **net** command in Windows 95 does not support the following:

- The functionality of the NetWare MAP ROOT command or search drive mappings.
- Any of the command-line options of the CAPTURE command, except the equivalents for specifying port, server name, and queue name. To use specific CAPTURE options, use the Novell CAPTURE command.
- The functionality of the Novell NetWare print job designations (the J=*jobname* parameter for the CAPTURE command).

Note You can still use the NetWare commands SLIST instead of **net view**, MAP instead of **net use**, or CAPTURE instead of **net use** to connect to a printer.

Using Windows NT to Connect to NetWare Servers

If your site includes both a Novell NetWare network and a Windows NT Server network, computers using Microsoft networking will need to communicate and share resources with the NetWare network. This section summarizes several options using Windows NT.

Windows NT Gateway Service for NetWare.

For Microsoft networking clients that cannot use multiple protocols, you can configure a computer running Windows NT Server 3.5 as a file or print gateway using Windows NT Gateway Service for NetWare to connect to and share NetWare resources. Notice that a Microsoft Windows NT Client Access License is required if the computer will be connecting to servers running Windows NT Server. For information, contact your Microsoft reseller.

As shown in the following illustration, Windows NT Gateway Service for NetWare acts as a translator between the SMB protocol used by Microsoft networks and the NCP protocol used on NetWare networks.

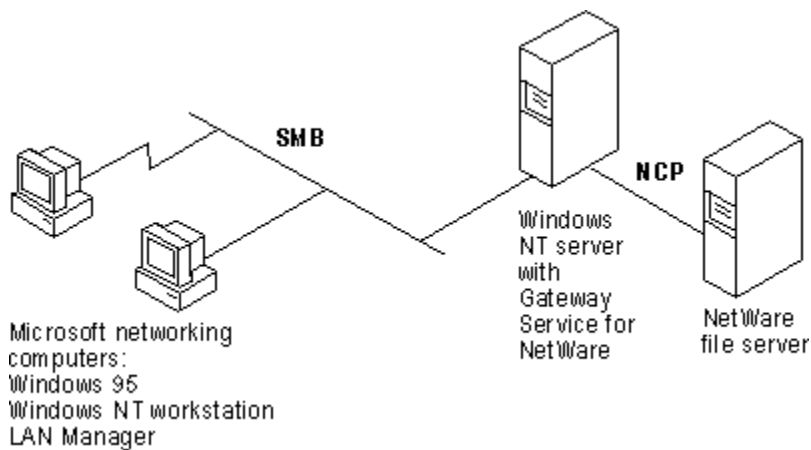

The file gateway uses a NetWare account on the Windows NT Server computer to create a validated connection to the NetWare server, which then appears on the Windows NT Server computer as a redirected drive. When the administrator shares the redirected drive, it looks similar to any other shared resource on the Windows NT Server computer. A print gateway functions in much the same way as the file gateway: the NetWare printer appears on the Windows NT network as if it were any other shared printer.

Because access over the gateway is slower than direct access from the client for computers running Windows 95 that require frequent access to NetWare resources, Client for NetWare Networks is a better solution. For information about setting up a Windows NT Server computer with Gateway Service for NetWare, see *Windows NT Server Services for NetWare Networks* in the Windows NT Server 3.5 documentation set.

Microsoft File and Print Services for NetWare.

This utility for Windows NT Server provides users running a NetWare-compatible client with access to basic NetWare file and print services and to powerful server applications on the same Windows NT Server-based computer. You can use Microsoft File and Print Services for NetWare to add a multipurpose file, print, and application server to your NetWare network without changing users' network client software.

Microsoft Directory Service Manager for NetWare.

This utility for Windows NT Server allows you to maintain a single directory for managing mixed Windows NT Server and NetWare 2.x and 3.x server networks.

For more information about these features or how to obtain Microsoft File and Print Services for NetWare, or the Microsoft Directory Service Manager for NetWare, contact your Microsoft sales representative.

Overview of Peer Resource Sharing

When a computer is running File and Printer Sharing services, other users running a compatible network client can connect to shared printers, volumes, CD-ROM drives, and directories on that computer by using the standard techniques for connecting the network resources, as described in [Browsing on NetWare Networks](#) and [Browsing on Microsoft Networks](#).

Using computers running Windows 95 as peer servers allows you to add secure storage space and printing to the network at a low cost. The peer service is based on a 32-bit, protected-mode architecture, which means all the Windows 95 benefits for robust, high performance are available. In addition, administrators can take advantage of features provided with Windows 95, such as Net Watcher and system policies, to centrally administer peer servers. In addition, user-level security is available as an additional enhancement beyond the peer server capabilities built into Windows for Workgroups.

Tip Using Net Watcher, a network administrator can remotely monitor and manage files on any computer running File and Printer Sharing services if remote administration has been enabled for that computer. Net Watcher allows an administrator to disconnect users, change access rights, and administer the file system on remote computers. For more information, see [Remote Administration](#).

Logon, Browsing, and Resource Sharing

Overview of Peer Resource Sharing

Installing Peer Resource Sharing

If you use custom setup scripts or choose the Custom option as the setup type in Windows 95 Setup, you can specify that File and Printer Sharing services be installed with Windows 95. Otherwise, you can add the service later by using the Network option in Control Panel.

Tip For a computer that will share resources with other users on the networks, choose which File and Printer Sharing service to install based on what other users require:

- If most users who need to share these resources are running NETX, VLM, or Client for NetWare Networks, then install File and Printer Sharing for NetWare Networks.
- If most users who need to share these resources are running Client for Microsoft Networks, Windows NT, Windows for Workgroups, or Workgroup Add-on for MS-DOS, then install File and Printer Sharing for Microsoft Networks.



To install File and Printer Sharing after Setup

1. In the Network option in Control Panel, click Add.
2. In the Select Network Component Type dialog box, double-click Service.
3. In the Select Network Service dialog box, click Microsoft in the Manufacturers list. Then, in the Network Service list, click the File and Printer Sharing service you want to install.

For information about enabling File and Printer Sharing in custom setup scripts, see [Custom, Automated, and Push Installations](#). For information about controlling peer resource sharing capabilities using system policies, see [User Profiles and System Policies](#).

Overview of Security for Peer Resource Sharing

For File and Printer Sharing for Microsoft Networks (but not NetWare), Windows 95 supports share-level security similar to the security provided with Windows for Workgroups. This level of security associates a password with a shared disk directory or printer. Share-level security for peer resource sharing can be implemented in a Windows 95-only peer-to-peer network or on a network supported by Windows NT or other Microsoft Windows network-compatible servers.

For File and Printer Sharing services on both Windows NT and NetWare networks, Windows 95 supports user-level security by linking a peer server directly to another server for user account validation. For network administrators, the user account list is centrally controlled at the Windows NT domain controller or NetWare server; on a Windows NT network, the user account list on a single server can also be used for validation. The resources on the Windows 95 peer server can be accessed only by users with accounts in the central database. Users can also be assigned specified access rights in Windows 95 for particular resources. For information about using and managing security, see [Security](#).

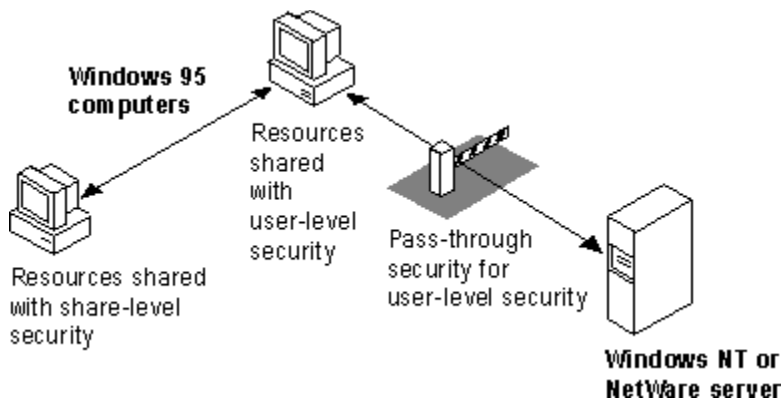

The 32-bit, protected mode network client and the File and Printer Sharing service are separate network processes, but they share connection information and pass requests to each other when validating a user-level security request.

For user-level security on a computer running either version of File and Printer Sharing service, you specify the server that contains the database of user accounts that are allowed to connect to this peer resource sharing server. You can do the following to customize access to a shared resource:

- You can use the Windows 95 user interface to specify which users can access the shared resources, and which rights they have. For details, see [Controlling Access to Peer Server Resources on NetWare Networks](#).
- For File and Printer Sharing on NetWare Networks, you can set up user rights remotely on the computer running Windows 95 by using NetWare utilities such as FILER.
- For File and Printer Sharing on Microsoft Networks, you can set up user rights remotely by using User Manager for Windows NT.
- You can use Net Watcher to monitor, add, and remove shared resources, as described in [Remote Administration](#).

When a user requests access to a shared resource under user-level security, Windows 95 checks for the user's logon name against the list of user accounts maintained on the server. If this is a valid user logon name, Windows 95 then checks whether this user has access privileges for this resource. If the user has access privileges, then the requested operation is allowed.

For an example of how pass-through validation works with peer resource sharing, see [Security](#).

Using File and Printer Sharing for Microsoft Networks

File and Printer Sharing for Microsoft Networks is the 32-bit, protected-mode Windows 95 SMB server (VSERVER.VXD) that supports all Microsoft networking products that use the SMB file-sharing protocol, including Windows for Workgroups, Windows NT, LAN Manager, LAN Manager for UNIX, AT&T StarLAN, IBM LAN Server, 3Com® 3+Open® and 3+Share®, and DEC PATHWORKS. Windows 95 enhances the features of Windows for Workgroups peer services by providing administrative control over whether peer sharing services are enabled, by adding user-based security capabilities, and by supporting long filenames.

The following summarizes some requirements for File and Printer Sharing for Microsoft Networks:

- The computer must use Client for Microsoft Networks.
- File and Printer Sharing for Microsoft Networks cannot run at the same time as NCP-based File and Printer Sharing for NetWare Networks.
- If user-level security is used, a Windows NT domain controller must be used for authentication.

The default settings for File and Printer Sharing are correct for most installations. You should need to change these settings in the following circumstances only:

- If you need to set Browse Master properties, as described in [Browsing on Microsoft Networks](#).
- If you want LAN Manager 2.x clients on your network to use resources on a computer running File and Printer Sharing for Microsoft Networks.

Use the Network option in Control Panel to configure the Browse Master and LM Announce parameters for the File and Printer Sharing service. For information about configuring security in Access Control properties, see [Security](#).



To specify Browse Master settings

1. In the Network option in Control Panel, double-click File and Printer Sharing for Microsoft Networks in the list of installed components.
2. In Advanced properties for File and Printer Sharing for Microsoft Networks, select Browse Master in the Property list.
3. Select an option in the Value list, as described in the following table.

Option	Description
Automatic	Specifies that this computer will maintain the browse list if Windows 95 determines that it is necessary. This is the default.
Yes	Specifies that this computer is to be used to maintain the browse list for computers in this workgroup.
No	Specifies that this computer is never used to maintain the browse list. Use this setting if the computer has little free memory or is connected by a slow link (such as a dial-up connection), or if other conditions create special performance problems.

At least one computer in the workgroup must have the value of Automatic or Yes for this parameter to ensure the browse list is available to network computers. This parameter is equivalent to the **MaintainServerList=** entry in the [network] section of SYSTEM.INI in Windows for Workgroups 3.11.

The LM Announce property controls whether a computer running File and Printer Sharing for Microsoft Networks can be seen by LAN Manager 2.x clients.



To specify LM Announce settings

1. In Advanced properties for File and Printer Sharing for Microsoft Networks, select LM Announce in the Properties list.
2. Select an option in the Value list, as described in the following table.

Option	Meaning
Yes	Specifies that you want this computer to announce its presence to other Microsoft networking computers in the workgroup, because there is a LAN Manager 2.x domain on the network. This value must be set to Yes if other computers in your workgroup need to see this computer when browsing the network.
No	Specifies that you do not want this computer to broadcast its presence to other computers. Setting this value to No minimizes the level of network traffic. Other users can still connect to this computer by specifying its UNC name in a Map Network Drive dialog box, but the computer will not appear in browse lists.

This parameter is the equivalent of the **LMAnnounce=** entry in the [Network] section of SYSTEM.INI in Windows for Workgroups 3.11. This value should be No unless there is a LAN Manager 2.x domain on your network.

A LAN Manager 2.x domain is known by browse servers in a workgroup only if at least one computer running Windows 95 (or Windows NT in the domain) is a member of that LAN Manager 2.x domain.



To make a computer running Windows 95 a member of a LAN Manager 2.x domain

- Set the workgroup name for the computer to be the same as the LAN Manager 2.x domain name. You can share a directory (or other resource) by selecting it in Windows Explorer or in My Computer and then configuring the related options. The following procedure describes how to share a directory on a computer where user-level security has been specified in the Network option in Control Panel. The steps for sharing resources with share-level security are similar to those for user-level security except that you do not select specific users. Rather, specify the type of access and define a password for the shared resource.



To share a directory (folder) with user-level security

1. In Windows Explorer, right-click the icon for the directory you want to share. In the context menu that appears, click Sharing.
2. Click the Sharing tab, and then type a share name for the directory.

Tip If you add a dollar sign (\$) to the end of the share name, the resource will not appear in Network Neighborhood or elsewhere when people browse network resources.

3. Click the Add button, and use the Add Users dialog box to specify which users can access the directory.

For more information about sharing folders on a Microsoft network, see online Help.

Using File and Printer Sharing for NetWare Networks

If you want to use File and Printer Sharing for NetWare Networks:

- The computer must use Client for NetWare Networks, rather than Novell-supplied client software.
- Only user-level security (not share-level security) is available.
- The service cannot run on the same computer as SMB-based File and Printer Sharing for Microsoft Networks.
- For pass-through validation when user-level security is enabled, there must be a Windows_Passthru account (with no password) on the NetWare server that is used as the security provider.

A computer configured with File and Printer Sharing for NetWare Networks uses the NCP file-sharing protocol to share resources with MS-DOS-based Novell NetWare computers, computers running Windows NT, and computers that have Client for NetWare Networks installed.

File and Printer Sharing for NetWare Networks supports long filenames and is Plug and Play-aware. This new implementation differs from peer resource sharing in Windows for Workgroups in two fundamental ways:

- File and Printer Sharing for NetWare Networks uses the NCP protocol instead of the SMB protocol. This means that any NetWare-compatible client (Client for NetWare Networks, NETX, or VLM) can connect to a computer running File and Printer Sharing for NetWare Networks.
- File and Printer Sharing for NetWare Networks uses user-level security. Access to a shared resource is based on the user's identity instead of on a password associated with that resource. The user database for verifying user identity is the bindery on a specified NetWare server.

This feature means that hundreds of NetWare users can, for example, access a shared CD-ROM using a single NetWare server connection. Also, trustee or other access rights can be defined per-directory for a shared CD-ROM.

When File and Printer Sharing for NetWare Networks is running on a computer, how that peer server appears to users browsing the network depends on how the peer server advertises itself:

- For another computer running Microsoft Client for NetWare Networks, the resources on the peer server appear exactly as any shared resources on the network. If the peer server is using Workgroup Advertising, it appears in a workgroup. A peer server using Service Advertising Protocol (SAP, the NetWare broadcasting protocol) Advertising will not appear in a workgroup, but it will appear in the Entire Network list.
- For a computer running NETX or VLM, any shared directories on a peer server that uses SAP advertising appear the same as volumes on any server. Any shared printers will appear as print queues. Most NetWare administrative commands work as expected, including RIGHTS, FILER, SYSCON, MAP, SLIST, VOLINFO, PCONSOLE, and CAPTURE. If the peer server is not using SAP Advertising, then users running NETX or VLM cannot see or connect to the peer server when browsing the network.

Sharing Resources on a NetWare Network: An Example

During the beta test phase for Windows 95, one NetWare system administrator found the peer resource sharing service to be an administrative lifesaver. A vice president at the company had CD-ROM hardware problems just when he needed immediate access to a tax program that was available only on compact disc.

The quick-thinking administrator installed File and Printer Sharing for NetWare Networks on a computer that had a CD-ROM drive. After making sure the vice president was assigned access rights, the administrator mapped a drive on the vice president's computer to access the shared CD-ROM.

The Windows 95 peer resource sharing service allowed the administrator to provide an immediate software solution to a hardware problem that would have taken much longer to solve.

Logon, Browsing, and Resource Sharing

Using File and Printer Sharing for NetWare Networks

Sharing Resources on a NetWare Network

To allow NETX and VLM clients on the network to access resources on the peer server, you must enable SAP Advertising in the properties for File and Print Sharing for NetWare Networks. The computer then appears as a server in SLIST listings, and users can map drives to connect to this computer. To see a list of volumes, users can use the VOLINFO command.

Note Administrative control over File and Printer Sharing for NetWare Networks is coupled with the printer sharing control — the option controlling the user's ability to share a local printer. If these sharing options are not selected in the Network option in Control Panel, then the File and Printer Sharing service is not loaded. However, if the administrator disables printer sharing or file sharing by setting the related option in a system policy file, then the File and Printer Sharing service still runs on the computer, but the related sharing options are not available.

Configuring Browsing for Resource Sharing on NetWare Networks

After you install File and Printer Sharing for NetWare Networks, you need to choose the method that computers browsing on the network will use to find this computer. You can browse by using two options:

- Workgroup Advertising, which uses the same broadcast method as used by workgroups on Microsoft networks.
- SAP Advertising, which is used by Novell NetWare 2.15 and above, 3.x, and 4.x servers to advertise their presence on the network. You must enable this option if you want the shared resources to be available to computers running NETX or VLM.

Note SAP Advertising has a theoretical limit of 7000 systems for browsing, and a practical limit of about 1500 systems. For a large peer network, use Workgroup Advertising.

For a general discussion of browsing when using NetWare-compatible clients, see [Browsing on NetWare Networks](#).



To specify the browsing preference

1. In the Network option in Control Panel, double-click File and Printer Sharing for NetWare Networks in the list of installed components.
2. In Advanced properties, select Workgroup Advertising to define how you want computers running Client for NetWare Networks to see and connect to this peer server.

-Or -

Select SAP Advertising if you want NETX and VLM clients to be able to connect to this peer server.

If you select Workgroup Advertising, you can set the following values.

Value	Description
Disabled	This computer will not be added to the browse list, and it cannot be seen by other members of the workgroup by using any method for browsing network resources.
Enabled: May Be Master	This computer is added to the browse list and can be promoted to master browse server if the preferred master is not available.
Enabled: Preferred Master	This computer is the master browse server for the workgroup.
Enabled: Will Not Be Master	This computer is added to the browse list by the master browse server, but it cannot be promoted to master browse server.

For more information about master browse server options, see [Building the Browse List for Microsoft Networks](#).

Note If Workgroup Advertising is used, each workgroup must have a master browse server at all times to track names and addresses for computers in the workgroup.

If you select SAP Advertising, you can set the following values.

Value	Description
Disabled	This computer will not advertise its presence, and NETX or VLM clients cannot see it by using SLIST or other browsing options, and cannot connect to it. Users running Client for NetWare Networks can see it if Workgroup Advertising is enabled on the peer server.

Enabled This computer will advertise its presence. It will appear in the Entire Network list. Users running VLM, NETX, and Client for NetWare Networks can see it by using any browsing methods, and they can connect to it as they do for any server.

By default, computers running File and Printer Sharing for NetWare Networks are placed in and browsed by workgroups. You can use the Identification properties in the Network option in Control Panel to specify the workgroup and computer name for the computer.

Although computers that use SAP advertising appear in the list of NetWare servers, you cannot use them in all the same ways that you use NetWare servers.

- When using NETX, you cannot log on to a computer running Windows 95 at the command line, although you can attach to one and map drives to its directories.
- When using VLM, you cannot log on to a computer running Windows 95 at the command line, but you can run a **login /ns** command and use the Login button in the NWUSER utility.
- If you run SYSCON on a NetWare server, you can change the server to one of the computers running Windows 95. However, the computer running Windows 95 does not have a bindery, so when you display all the users (or groups) in SYSCON, you will see the user list (or group list) from the NetWare server that was selected as the user-level security provider.
- If you run VOLINFO on a NetWare server, you can select one of the computers running Windows 95 and display its volume information (if you are attached to it). This shows all the available shared disk resources for the computer running Windows 95.

In Windows 95, you can do the same things to resources on computers running File and Printer Sharing for NetWare Networks as you can to any other network resource. If you have appropriate rights to connect to the shared resources, you can also create a link to the computer or map a drive to its shared directories, and so on.

Note Each computer configured with File and Printer Sharing for NetWare Networks logs on to the NetWare server that provides security, to get access to the bindery, using the Windows_Passthru account. This logon process takes place in the background, without user intervention. One connection to that NetWare server is used as needed for each computer running File and Printer Sharing for NetWare Networks, and it is disconnected if it is not needed for 30 seconds.

If a connection already exists, Windows 95 uses that connection and makes a new connection only when required.

Controlling Access to Peer Server Resources on NetWare Networks

You can add to the list of users who can access the resources on the peer server. To do this, add the users to the NetWare pass-through server that provides security. These users can then be given access to the peer server by adding them to the Sharing properties associated with the shared resource.

Passwords for users' resources on the peer server are the same as those for the NetWare pass-through server. Passwords must be changed at that server, as described in [Unified System Logon Basics](#).

To make sure all users have the required server access

- Make sure that one NetWare server on the network has the accounts for all users or all servers, and then set that server as the security provider for every computer configured with File and Printer Sharing for NetWare Networks.

If server access is not set properly, each time the computer running Windows 95 is started a message warns that the pass-through server has not been specified.

To share a directory and specify users on a NetWare network

1. In Windows Explorer, right-click the directory you want to share. In the context menu, click Sharing.
2. In the Sharing dialog box, type a share name for the directory.
3. Click the Add button. In the Add Users dialog box, select the user name in the list on the left, and then click the related button to specify the kind of access that user is allowed.

For more information about using the Add Users dialog box, see online Help. For more information about specifying directory access rights, see [Security](#).

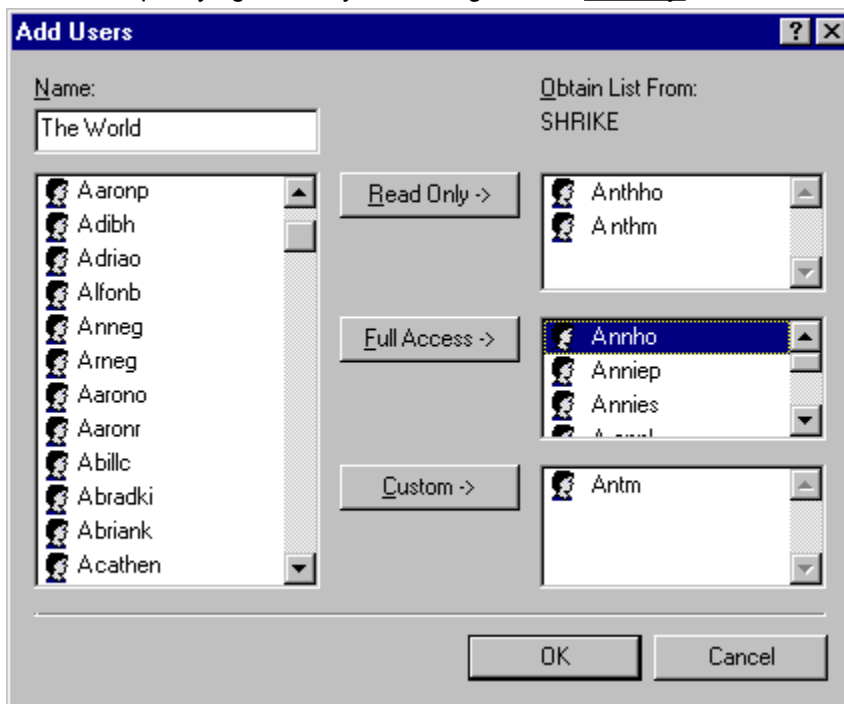

Notice in the illustration that the list of users shown in the Add Users dialog box is from the TRIKE server's bindery. This means two things:

- All user management is done in the name space of the existing NetWare server. The NetWare

server is administered by using all the same tools that are currently in place; Windows 95 has not added another name space to administer.

- Only valid user accounts and groups on TRIKE can be specified for shared resources on the peer server.

When the computer running Windows 95 receives a request from a user attempting to access a shared device, Windows 95 uses the NetWare server to validate the user name or group membership. If the name or group membership is validated, then Windows 95 checks to see if this validated name or group has been granted access rights to the shared resource, and then it grants or denies the connection request.

Share Names vs. NetWare Volume Names

When you share resources on a local hard disk drive using File and Printer Sharing for NetWare Networks, the share name associated with the shared directory structure becomes a volume name in the Novell designation *server/volume*: or the UNC designation *\\server\volume*.

You can use the UNC designation with **net** commands to connect to and disconnect from either Microsoft networking *\\server\sharename* shares or NetWare *server/volume* shares.

Windows 95 does not make this distinction between shares and volumes because all shares and volumes appear as directories (also called folders). This distinction becomes important when you use NETX or VLM and NetWare utilities. NetWare does not use or understand the concept of share names. NetWare uses volumes for drive resources and print queue names for print resources.

Therefore, for a shared drive or printer resource to be available to all the different types of clients, when a computer configured with File and Printer Sharing for NetWare Networks shares a drive resource, the share name becomes equivalent to a NetWare volume. When this same computer shares a printer resource, the share name becomes equivalent to the NetWare print queue.

```
DIRECTORY SHARE NAME ---->  VOLUME
PRINTER SHARE NAME ----->  PRINT QUEUE
```

Logon, Browsing, and Resource Sharing

Using File and Printer Sharing for NetWare Networks

Using Bindery Emulation for Pass-Through Security

File and Printer Sharing for NetWare Networks grants access to printers and directories on a per-user basis, which requires the name of the server to retrieve the names of users on a network. For NetWare versions 2.15 and 3.x servers, all the information for users, groups, passwords, and rights is stored in a database on the server called the bindery. NetWare version 4.x servers can appear to have a bindery using bindery emulation, which is enabled by default. Windows 95 can use the bindery of one NetWare server.

Usually, companies have multiple NetWare servers for different departments, and individual users log on to a different server by department. Problems can occur when the list of accounts differs between NetWare servers. For example, assume that AnnieP and YusufM log on to the SALES server, and Krisl is on the R&D server. AnnieP can select only one server for pass-through validation, so she must select the SALES server, because that's where this account is located for logon. She can grant access to YusufM, but not to Krisl.

Troubleshooting for Logon, Browsing, and Peer Resource Sharing

This section provides some general methods for troubleshooting.

Setup doesn't run the login script.

If the network logon server or domain controller is not validating the user account, the login script will not run. Check the following:

- The network connection
- The user name
- The user password
- The basic network functionality
- The domain or server logon validation

If the network logon server or domain controller is validating the user account, do the following:

- Check the network connection.
- Verify that the login script is present in the home directory (on a Windows NT network) or in the user's mail directory (on a NetWare network).
- Check for enough memory on the client computer.
- Check for and remove unnecessary drivers and TSRs, and then try to log on again.

You cannot browse to find SMB-based servers in the workgroup while using Client for Microsoft Networks.

There might be no SMB-based servers in the workgroup (computers running Windows NT, LAN Manager, or File and Printer Sharing for Microsoft Networks). Windows 95 does not support browsing in a workgroup that does not contain an SMB-based server if the computer is running Client for Microsoft Networks. The following presents a solution.



To make sure there is an SMB-based server in the workgroup

- On a computer running File and Printer Sharing for Microsoft Networks, make sure the service is configured as the master browser server.
- Or -
- Make sure that a Windows NT server computer is a member of the workgroup (or domain).

Access to an NCP-based server changes if SAP Advertising is defined.

Where you access an NCP-based peer resource server in Network Neighborhood can change, depending on whether the server is configured for Workgroup Advertising or SAP Advertising.

- If the computer running File and Printer Sharing for NetWare Networks is configured for Workgroup Advertising, that peer server appears as a computer in its workgroup.
- If the File and Printer Sharing server is configured for SAP Advertising, it appears with the other Novell NetWare servers at the beginning of the list of workgroups in the Entire Network window of Network Neighborhood.

To set SAP Advertising or Workgroup Advertising, follow the procedures in [Configuring Browsing for Resource Sharing on NetWare Networks](#).

User cannot connect to any network resource.

- Check the workgroup assignment.
- Check the domain or preferred server assignment for the protected-mode network client.
- Check the rights for the user as defined on the domain or preferred server.
- Check the basic network operations.
- Use **net view** *\\computer name* to view shared resources.
- Check for the termination of the local network cable.

Others cannot connect to my shared resources.

- In the Network option in Control Panel, verify that the File and Print Sharing service appears in the list of installed components.

- Make sure other users are running a common protocol.

Network Neighborhood doesn't show servers.

- Verify that at least one active server is on the local network.
- Verify that the proper network clients are installed and, if necessary, reinstall them.
- Verify that the user is logged on to the particular network.
- Check the network protocol settings.
- Check that the IPX Frame Type is set to Auto or to the same type as the server.
- Check the network cable termination.

You can't connect to a specific server.

- Check error message details, if available.
- Verify that you can connect to any server.
- Verify that you can connect to a specific server from other computers. If you cannot connect to the specific server from other systems, it probably indicates a problem with that server or the cabling or routing to it. Also verify termination of the local network cable.

The network redirector or server is not responding.

If the computer running Windows 95 is not responding properly as a client or server, use System Monitor to view statistics about the activity of the installed network servers and redirectors. If there is no activity, remove the client or server on the Network option in Control Panel, and then reinstall and try again.

You cannot see computers running Windows 95 on the other side of a router on a NetWare network.

This might be related to the IPX network number. An IPX client (such as a computer running Client for NetWare Networks) determines its network number by sending Routing Information Protocol (RIP) requests to the nearest IPX router. If the router is configured incorrectly, all IPX clients on that network can be adversely affected. Network numbers are assigned in the server's AUTOEXEC.NCF file when the network adapter drivers are loaded and IPX is bound to the logical adapter.

Access is denied for Windows for Workgroups users trying to connect to shared resources on a computer running File and Printer Sharing for Microsoft Networks.

If the user with the Windows for Workgroups client computer is logging on to a different domain from the computer running File and Printer Sharing services (the peer server), then Windows 95 cannot confirm logon validation for access to shared resources. To solve this problem, do one of the following:

- Upgrade the Windows for Workgroups clients to Windows 95 (recommended).
- Set the LM Announce option to Yes in the Advanced properties for File and Printer Sharing for Microsoft Networks on the peer server.
- Switch to share-level security on the peer server.
- Change the logon domain for the Windows for Workgroups clients.

This problem will not occur in these cases: if the client computers are running Windows 95 or Windows NT; if the peer server uses share-level security; or if the same domains are used for the client computer's logon domain and the domain specified for pass-through validation in the peer server's Access Control properties.

A user is incorrectly denied access to resources on a peer server on a Windows NT network.

If a user is denied access to resources on a computer running File and Printer Sharing for Microsoft Networks with user-level security, you should first determine which security provider is specified for the peer server. Then, see if the client can be validated by that security provider directly without going through the peer server.

If this is successful, verify that the user is on the access control list for the shared resource on the peer server. Remove that user from the list of users and then add the name back. If this is unsuccessful, reconfigure the peer server to use another security provider that you know can validate the user.

You need to manage SAP Advertising on computers running File and Printer Sharing for NetWare Networks.

The SAP Advertising option is disabled by default for File and Printer Sharing on NetWare Networks. If

you need to enforce the configuration of the File and Printer Sharing service, you can set the Disable SAP Advertising policy under the Default Computer policies.

In general, you will want to enable SAP Advertising only on computers with resources such as CD-ROM drives that you want to share with NETX and VLM clients. SAP Advertising is not required for sharing resources only among computers running Windows 95. Notice the following:

- SAP Advertising is not required if you want to use Net Watcher to administer the file system on a computer running File and Printer Sharing for NetWare Networks.
- Neither SAP Advertising nor File and Printer Sharing for NetWare Networks is required for remote Registry administration. The only requirement is user-level security with a pass-through server specified.

Windows 95 peer servers with SAP Advertising enabled will respond to GetNearestServer broadcasts. If this causes a NETX or VLM client to attempt to log in to a peer server, Windows 95 makes sure these NETX and VLM clients connect to a real NetWare server by using a stub file named LOGIN.EXE in the Windows NWSYSVOL\LOGIN directory. This directory is created automatically when File and Printer Sharing for NetWare Networks is installed, and it is automatically shared with read-only privileges whenever SAP Advertising is enabled on the peer server.

When a NETX or VLM client attaches to a Windows 95 peer server to attempt to log in, the peer server uses its LOGIN.EXE stub to perform the following actions:

- First, the peer server makes an implicit connection to the NETX or VLM client and maps the first drive letter on that client to SYS:\LOGIN.
- Then the peer server attaches to a real NetWare server and sets this server as the real primary and preferred server for the NETX or VLM client. The NetWare server used is one of the following (in order of preference):
 - The Preferred Server specified for the network client
 - The server specified in AUTOEXEC.BAT (or in a batch file called from AUTOEXEC.BAT) for this Windows 95 computer
 - The pass-through server specified for validating connections for File and Printer Sharing on this Windows 95 computer
- Finally, the LOGIN.EXE stub performs a global logout, remaps, and starts the login process with the real NetWare server. There is a chain execution of the real LOGIN.EXE from the real NetWare server, using identical parameters, to finish the connection for the NETX or VLM client.

The real-mode client does not detect any of these events — it just receives the login connection it wanted with a NetWare server, even though a Windows 95 peer server first intercepted its GetNearestServer broadcast.

Introduction

This chapter describes technical issues related to network adapters and protocols for Windows 95, and also presents some technical notes and tips for networking.

- Network Adapter Drivers and Protocols: The Basics
 - NDIS Driver Basics
 - Network Protocol Basics
- Network Adapters and Protocols: The Issues
- Network Adapters and Windows 95
 - Configuring Network Adapters
 - Setting LAN Adapter Numbers
 - Technical Notes on Network Adapters
- IPX/SPX-Compatible Protocol
 - Configuring IPX/SPX-Compatible Protocol
 - Using NetBIOS over IPX
 - IPX/SPX Technical Notes on NetWare Networks
- TCP/IP Protocol
 - Configuring TCP/IP with DHCP
 - Configuring TCP/IP Settings Manually
 - Name Resolution for Windows Networking
 - Using WINS for Name Resolution
 - Using DNS for Name Resolution
 - Microsoft TCP/IP Registry Parameters
- Microsoft NetBEUI Protocol
- Using WinPopup to Broadcast a Pop-Up Message
- Troubleshooting Protocol Problems

Network Adapter Drivers and Protocols: The Basics

A network adapter (sometimes called a network interface card, or NIC) is a hardware card installed in a computer so it can communicate on a network. The network adapter provides one or more ports for the network cable to connect to, and it transmits and receives data onto the network cable.

Every networked computer must also have a network adapter driver, which controls the network adapter. Each network adapter driver is configured to run with a certain type of network adapter.

A networked computer must also have one or more protocol drivers (sometimes called a transport protocol or just a protocol). The protocol driver works between the upper-level network software and the network adapter to package data to be sent on the network.

For two computers to communicate on a network, they must use identical protocols. Sometimes, a computer is configured to use multiple protocols. In this case, two computers need only one protocol in common to communicate. For example, a computer running File and Printer Sharing for Microsoft Networks that uses both NetBEUI and TCP/IP can communicate with computers using only NetBEUI or only TCP/IP.

In Windows 95, all network adapter drivers and protocols supporting protected-mode clients are configured by using the Network option in Control Panel rather than by manually editing configuration files. Configuration values are stored in the Registry.

NDIS Driver Basics

Windows 95 supports the Network Device Interface Specification (NDIS) versions 2.x and 3.1 protocol and adapter drivers, and provides an NDIS 3.1 replacement for version 3.0 drivers, which are incompatible with Windows 95.

By using NDIS 3.1 drivers, Windows 95 can support a wide range of network media, including Ethernet, token ring, and ArcNet®. The NDIS 3.1 specification accommodates Plug and Play features, so that in many cases network adapters can be added and removed dynamically while the computer is running. The related features and benefits are summarized in the following discussion.

Plug and Play support for network protocols and adapters.

Because of Plug and Play enhancements, the operating system can determine automatically the adapters to which each protocol should bind. If a Plug and Play event occurs, such as removing a PCMCIA network adapter from a portable computer, the NDIS 3.1 protocols and network adapter drivers remove themselves from memory automatically. (This Plug and Play capability is supported for most PCMCIA adapters, but not for most ISA adapters, which have power considerations.)

New NDIS mini-driver model.

The mini-driver provided by the adapter manufacturer implements only the half of the Media Access Control (MAC) layer functionality that is specific to the network adapter, which includes establishing communications with the adapter, turning on and off electrical isolation for Plug and Play, providing media detection, and enabling any value-added features the network adapter may contain.

The Windows 95 NDIS wrapper implements the half of the MAC functionality that is common to all NDIS drivers. The new mini-drivers are faster and roughly 40 percent smaller than earlier versions of NDIS 3.x network adapter drivers. The Windows 95 mini-drivers are also binary-compatible with Windows NT 3.5 mini-drivers, which means they can be used without recompiling. (You can recognize a mini-driver by its .SYS filename extension; other drivers have .VXD extensions.)

Real-mode NDIS 2 support.

An NDIS 2.x protocol under Windows 95 must use an NDIS 2.x network adapter driver. Both the protocol and network adapter drivers must load and bind in real mode before running for Windows 95. Values in PROTOCOL.INI are used to load the real-mode NDIS drivers, as described in [Windows 95 on Microsoft Networks](#). However, you still use the Network option in Control Panel to configure NDIS 2 adapters.

When you run a real-mode network (for example, when using Safe Mode with Networking for system startup), Windows 95 uses NDIS 2 versions of NetBEUI and IPX/SPX protocols. These protocols are not intended for everyday use, since Windows 95 supplies faster protected-mode versions of these protocols. These real-mode protocols are also provided for client computers that start from a floppy disk and run a shared copy of Windows 95 from a server.

Windows 95 also supports existing ODI drivers with Novell® NetWare®-compatible network clients. For information, see [Windows 95 on NetWare Networks](#).

Network Protocol Basics

Windows 95 network protocols are implemented as 32-bit, protected-mode VxDs that offer high performance and use no conventional memory. Windows 95 can support multiple protocols simultaneously, and protocol stacks can be shared among the installed network clients. For example, the IPX/SPX-compatible protocol can support both Client for NetWare Networks and Client for Microsoft Networks. The following protocols are included with Windows 95.

Microsoft IPX/SPX-compatible protocol.

This protocol is compatible with the Novell NetWare Internetwork Packet Exchange/Sequential Packet Exchange (IPX/SPX) implementation. Windows 95 includes both 32-bit, protected-mode and real-mode support for this protocol. This protected-mode protocol provides the following benefits:

- Supports any Novell NetWare-compatible network client
- Supports packet-burst mode to offer improved network performance
- Supports the Windows Sockets, NetBIOS, and ECB programming interfaces
- Support for automatic detection of frame type, network address, and other configuration settings
- Connectivity with servers and workstations on NetWare or Windows NT Server 3.5 networks, and mixed networks
- Routable connectivity across all network bridges and routers configured for IPX/SPX routing

Microsoft TCP/IP.

This is a complete implementation of the standard, routable Transmission Control Protocol/Internet Protocol (TCP/IP) protocol. Windows 95 includes only protected-mode support for this protocol. Microsoft TCP/IP provides the following benefits:

- Support for Internet connectivity and the Point-to-Point Protocol (PPP) used for asynchronous communication
- Connectivity across interconnected networks with different operating systems and hardware platforms, including communication with many non-Microsoft systems, such as Internet hosts, Apple® Macintosh® systems, IBM® mainframes, UNIX® systems, and Open VMS™ systems
- Support for automatic TCP/IP configuration using Windows NT Dynamic Host Configuration Protocol (DHCP) servers
- Support for automatic IP-address-to-NetBIOS computer name resolution using Windows NT Windows Internet Naming Service (WINS) servers
- Support for the Windows Sockets 1.1 interface, which is used by many client-server applications and many public-domain Internet tools
- Support for the NetBIOS interface, commonly known as NetBIOS over TCP/IP
- Support for many commonly used utilities, which are installed with the protocol

Microsoft NetBEUI.

This protocol is compatible with existing networks that use the NetBIOS extended user interface (NetBEUI), including Windows for Workgroups peer networks, Windows NT Server, LAN Manager, and other networks, and includes support for a NetBIOS programming interface. Windows 95 provides both protected-mode and real-mode support for this protocol.

NetBEUI was first introduced by IBM in 1985, when it was assumed that LANs would be segmented into workgroups of 20 to 200 computers and that gateways would be used to connect one LAN segment to other LAN segments or to a mainframe. NetBEUI is optimized for high performance when used in departmental LANs or LAN segments. Microsoft NetBEUI under Windows 95 is completely self-tuning and provides much better performance over slow links than did earlier versions of NetBEUI.

All three protocols are Plug and Play-compliant, so they can be loaded and unloaded automatically. For example, if a PCMCIA network adapter is removed from the computer so that the network is no longer available, the protocols are unloaded automatically after any dependent applications have been notified.

Network Adapters and Protocols: The Issues

Windows 95 Setup automatically configures a computer to use protocols and drivers to match network components that are running when Setup is started.

If you are setting up Windows 95 for a new networking option, you must choose which types of network adapter drivers and protocols to use. Because Windows 95 has an open architecture, you have a lot of flexibility in this decision. Windows 95 supports both NDIS and Transport Driver Interface (TDI) standards, allowing Windows 95 to communicate with many other networking products and making it possible to choose from a variety of network adapters and protocols.

This section describes basic issues for choosing network adapter drivers and protocols to support your networking needs.

Choosing adapters and drivers for best performance.

Network adapters have become exceptionally reliable and inexpensive. The low cost of Ethernet adapters, including new Plug and Play hardware, means that usually the cost-effective way to improve network performance is to replace an older network adapter with a new model. The cost for the new hardware is offset almost immediately by savings in support time and improved performance. In choosing a new network adapter, you should also consider buying an adapter that matches the computer bus. For example, PCI network adapters are available for use in PCI computers.

Choosing separate protocol and adapter drivers.

With some networks, each computer's network adapter driver and protocol are separate pieces of software. With other networks, a single piece of software called a monolithic protocol stack acts as both adapter driver and protocol. Microsoft recommends that you choose separate 32-bit, protected-mode protocols and drivers rather than monolithic stacks, which run only in real mode. However, Windows 95 includes mapping technology for users who must continue to use real-mode NDIS 2 or ODI drivers.

Choosing NDIS versus ODI drivers.

Windows 95 supports NDIS versions 2.x and 3.1. All network adapter drivers and protocols provided with Windows 95 conform to NDIS. You can use any combination of protocol and network adapter drivers that conforms to NDIS. Microsoft recommends that you use NDIS 3.1 drivers whenever possible with Windows 95.

The Open Datalink Interface (ODI) specification was defined by Novell and Apple Computer to provide a protocol and API for communicating with network adapter drivers, and to support the use of multiple protocols by a network adapter driver. To ensure the most flexibility in Windows 95, Microsoft recommends that you use NDIS 3.1 drivers whenever possible if you are running Windows 95 with Microsoft Client for NetWare Networks. If you are using a Novell-supplied network client, Novell recommends using ODI-based client software rather than monolithic IPX drivers.

Choosing a protocol.

Windows 95 can support multiple network protocols, and can share a protocol among the network providers that are installed. You might choose more than one protocol to ensure communication compatibility with all systems in the enterprise. However, choosing multiple protocols can cause more network traffic, more memory used on the local workstations, and more network delays. You probably want to choose a single protocol wherever possible. The following briefly presents some issues for each Windows 95 protocol.

For the IPX/SPX-compatible protocol:

- This protocol is required and installed automatically with Microsoft Client for NetWare. When Windows 95 Setup determines that it cannot install Client for NetWare Networks on a computer running a Novell-supplied network client, Setup still tries to install this protected-mode protocol. For information about how Setup determines whether to install this protocol automatically, see [Windows 95 on NetWare Networks](#).
- This protocol cannot be used to configure Windows 95 to support NetWare over ArcNet. Instead, you must use real-mode IPX drivers with NetBIOS support on ArcNet network adapters.
- With this protocol, it is not necessary to load the Novell-supplied VIPX.386 driver, because the Microsoft protocol provides virtualized services to all VMs and applications.

For Microsoft TCP/IP:

- TCP/IP in general has been known to require careful planning and management of the IP address space. However, this problem is vastly reduced when DHCP servers are used to manage assignment of IP addresses for computers running Microsoft TCP/IP.
- If you want to take advantage of DHCP for automatic IP addressing or use WINS for name resolution on computers running Windows 95, the appropriate Windows NT servers must be in place on the network.
- This protocol cannot be used on NetWare networks that require NetWare/IP.

For Microsoft NetBEUI:

- NetBEUI is a nonroutable protocol that cannot cross routers, although it can cross bridges and source routing bridges.
- NetBEUI is optimized for high performance only for use in departmental LANs or LAN segments.

One common method for setting up a network is to use NetBEUI plus a protocol such as TCP/IP on each computer that needs to access computers across a router. If you set NetBEUI as the default protocol, Windows 95 uses NetBEUI for communication within the LAN segment and uses TCP/IP for communication across routers to other parts of the WAN.

Network Adapters and Windows 95

Windows 95 supports up to four network adapters in a single computer. Windows 95 Setup automatically detects most network adapters, installs the appropriate driver for the adapter, and provides appropriate default settings to configure the adapter. If you add a new network adapter, its driver is bound automatically to all NDIS protocols currently running on the computer; if any protocols are added later, they will also be bound automatically to the network adapter driver.

This section provides technical details for configuring network adapters, setting LAN adapter numbers, and other technical notes. For specific information about PCMCIA adapters, see [Devices](#).

Note For information about specific network adapters, see the SETUP.TXT and README.TXT files in the Windows 95 distribution disks.

Configuring Network Adapters

This section discusses how to configure properties for network adapter drivers.

Important If you add a new network adapter after Windows 95 is installed, you should use the Add New Hardware option in Control Panel to install the correct driver for the adapter.

When you use the Add New Hardware option, be sure to choose Detection for determining the correct driver and resource assignment. You should configure network adapter drivers manually only after you have tried all detection and automatic configuration methods.

If you experience problems with settings for a network adapter, you should begin troubleshooting by removing the network adapter driver in the Network option in Control Panel. Then use the Add New Hardware option to reinstall support for the network adapter, using detection to ensure that Windows 95 determines the correct adapter driver and standard settings for that network adapter.



To configure properties manually for network adapter drivers

- In the Network option in Control Panel, click the Configuration tab. Select the driver in the list, and then click Properties.



To specify the driver type for a selected network adapter

1. In the properties for the network adapter, click the Driver Type tab.
2. Click one of three options (if available for the specific adapter), as described in the following table.

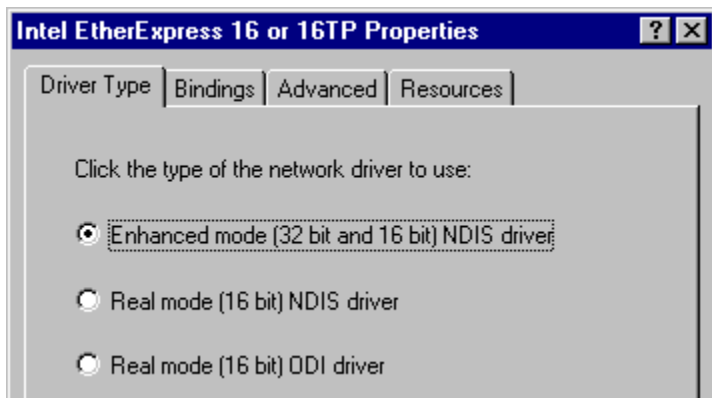

Network adapter driver type	Description
Enhanced mode (32-bit and 16-bit) NDIS driver	Installs an NDIS 3.1-compliant driver. This is the preferred driver type for use with 32-bit, protected-mode network clients.
Real-mode NDIS driver	Installs an NDIS 2.x-compliant driver.
Real-mode (16-bit) ODI driver	Installs a real-mode driver created to support ODI for Windows 3.1 on NetWare networks.

Binding Network Adapter Drivers to Protocols

For a protocol to communicate with each network adapter on your computer, the network adapter driver

must be bound to the protocol. The bindings define the relationships between networking software components. Windows 95 automatically binds the appropriate protocols to the network adapter.

You can change the bindings, for example, if you do not want to use a specific protocol with a particular network adapter. Or, as another example, if the computer is on a local area network and is also connected to the enterprise internetwork, you might not want the computer's shared resources to be seen on the internetwork. In that case, you can disable the binding between the related protocol and the adapter that connects the computer to the internetwork.



To configure bindings between a network adapter and installed protocols

1. In the properties for the selected network adapter, click the Bindings tab.
In the list, the protocols that are bound to the selected adapter are checked. If a particular protocol does not appear in the list, check that it is installed correctly by returning to the Configuration properties dialog box and reinstalling it.
2. If you do not want this network adapter to be bound to a particular protocol, click the check box beside the protocol to clear the check.

Configuring Network Adapter Resource Settings

Windows 95 can determine hardware settings for most network adapters. For this reason, the recommended method for installing or configuring network adapter drivers is to use the Add New Hardware option in Control Panel, using detection to determine the correct driver and resource settings. You should accept the proposed settings unless you are absolutely sure they are incorrect.

Most devices cannot share IRQ settings, memory buffer addresses, or ROM addresses. Where possible, Windows 95 identifies and resolves conflicts. However, if one of the supported devices does not seem to work, the problem may be the particular hardware configuration. To make sure there are no conflicts among network adapters or other peripherals, or between the system board and adapters, check the settings in Device Manager, as described in [Devices](#).

Sometimes settings for network adapters are set with software, sometimes with jumpers or switches on the hardware (refer to your hardware documentation for specific details). If settings for a network adapter can be configured through software, you can configure settings using the Network option in Control Panel.



To configure resources in a network adapter's properties

1. In the properties for the network adapter, click the Resources tab.
2. Click the option named Use These Hardware Settings, and confirm values for the listed settings by comparing the proposed settings with the values recommended in the documentation for the adapter.
3. To select from the available values for a setting, click the arrow beside the setting's current value.
 - A hash (#) character appears by current settings.
 - An asterisk (*) appears beside settings that conflict with another device in the system. You should avoid this setting or reconfigure the other devices to use different settings.

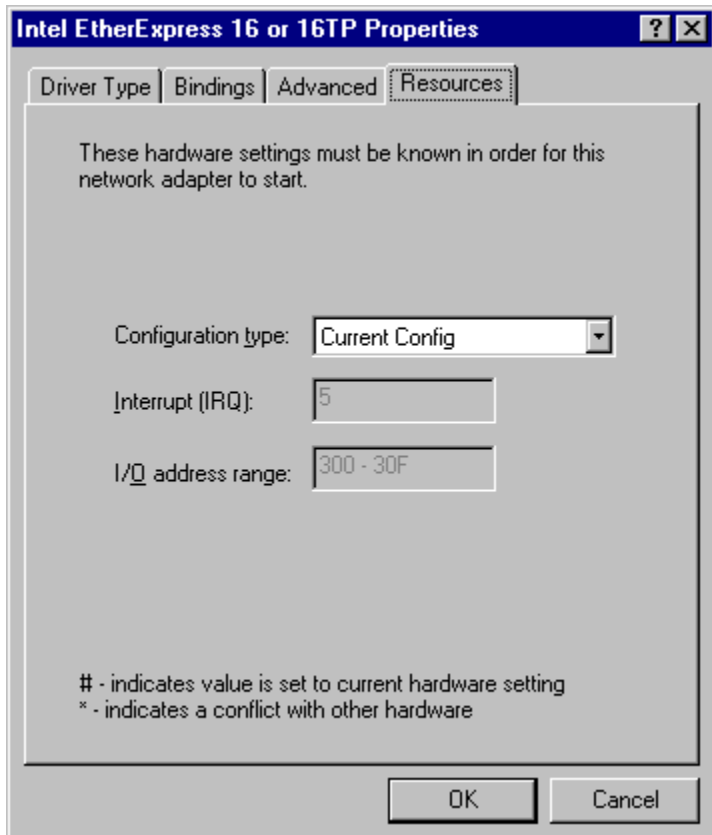

The settings available depend on the type of network adapter. For example, for Intel adapters, you cannot set the IRQ using the adapter's properties. The following table describes a few typical settings.

Examples of Hardware Resource Settings for a Network Adapter

Setting type	Description
I/O Address Range	Specifies the reserved memory address range (as a hexadecimal value) that the adapter can use for temporary storage of I/O data.
Interrupt (IRQ)	Specifies the hardware line over which the device can send interrupts (requests for service) to the computer's CPU.
Memory Address	Specifies the base memory address (as a hexadecimal value) used by this network adapter. This number must match the adapter's memory address settings, as specified in the documentation for the adapter.

Each alternate Configuration Type that might be listed in the Resources properties for a network adapter refers to a possible hardware configuration for the adapter (rather than software settings for the driver) as defined by the manufacturer.



To configure a network adapter that has alternate Configuration Types

- Run the Add New Hardware option in Control Panel, and let Windows 95 detect the hardware. If you must set the configuration manually, use the settings prescribed in the documentation provided by the manufacturer to set Resources and Advanced properties using the Network option in Control Panel.

The following table describes the network adapters that have alternate Configuration Types under Windows 95. For more information about these configurations, see the documentation from the hardware manufacturer.

Network adapter	Alternate Configuration Types
3Com® EtherLink II®-16	Memory Mapped (RAM), Programmed I/O (PIO)
DEC™ Etherworks™ 3	2K (option 0), 32K (option 1), 64K (option 2)
HP® ISA	Memory Mapped (RAM), Programmed I/O (PIO)
NE2000+	Can use shared RAM (memory-mapped), but this mode is not supported under Windows 95
Proteon 1390, 1392, 1392+	Memory Mapped (RAM), Programmed I/O (PIO)

For legacy network adapters, the settings that appear in the Resources properties are only some possible settings for the adapter driver, but many adapters have additional settings that can be programmed by running a configuration utility from the adapter manufacturer or by setting jumpers on the adapter itself. Although some of these settings do not appear in the adapter's properties, the resources used could cause conflicts with other system components.

This also means that configuring most legacy network adapters in Windows 95 consists only of specifying the preprogrammed values for the adapter hardware. Changing values for most network adapters by setting properties in Windows 95 does not reprogram the adapter itself. You can verify hardware settings for network adapters only by running the hardware configuration program to view settings, or by checking how the jumpers are set on the adapter itself.



To reprogram adapter settings

1. Use the configuration disk that came with the adapter to reprogram it.
2. Write down the settings made so that you can refer to them in the following step.
3. In the Network option in Control Panel, change the settings to the ones you noted. Then shut down

and restart the computer.

For some legacy adapters, it is possible that the adapter uses resources not listed with the Resource properties. For these adapters, the NDIS driver determines the resource settings directly from the adapter itself. Even though these resources do not appear in the list, they can still conflict with other devices. For example, the resource list for the IBM Token Ring adapter shows only the I/O settings, but this adapter also uses IRQ and Memory resources.

Configuring Advanced Properties for Network Adapters

The options available in the Advanced properties vary, depending on the type of network adapter. For information about specific settings that appear for a selected network adapter, see the documentation provided by the manufacturer for the adapter and driver. The manufacturer can also provide guidelines for when to change the default values for advanced configuration options.



To specify advanced settings for the network adapter

1. In the properties for the selected network adapter, click the Advanced tab.
2. To change these values, select an item in the Property list, and then select a setting in the Value box.
3. Click the OK button. Then restart the computer for the changes to take effect.

This example shows the advanced options for an Intel EtherExpress network adapter.

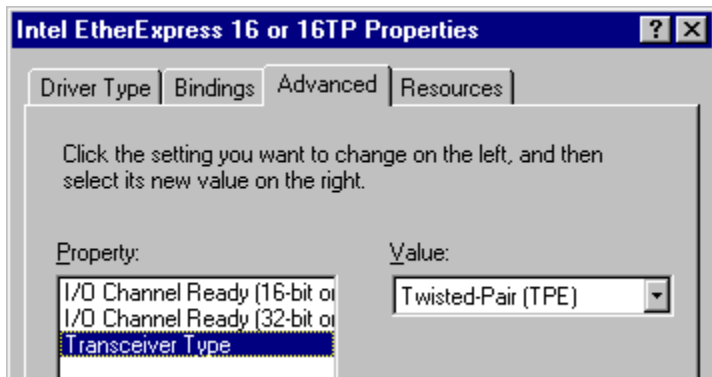

The following examples show some typical settings for general types of network adapters. Network adapters that use the new, fast Ethernet technology might have many more settings. Examples of such adapters include SMC EtherPower 10/100 (9332) PCI Ethernet Adapter, DEC Etherworks 435, and Intel EtherExpress PRO/100. For an explanation of specific settings for a network adapter, see the documentation provided by the adapter manufacturer.

Example setting Description

For Ethernet adapters:

- | | |
|------------------------------------|---|
| Transceiver Type (cable connector) | The transceiver is the device that connects a computer to the network, defined as one of the following values: <ul style="list-style-type: none">• Thick Net, for an AUI or DEC/Intel/Xerox (DIX) connection.• Thin Net, for a BNC or coaxial (COAX) connection.• Twisted Pair, for a TPE connection. |
|------------------------------------|---|

For token-ring adapters:

- | | |
|-----------------------|--|
| I/O Port Base Address | This value specifies the base memory address used by the adapter. To set the I/O address of an IBM 4/16 token-ring adapter, select either Primary (A20) or Secondary (A24) for this value. In this case, the driver ignores the I/O settings in the Resource properties. |
| Network Address | By default, Windows 95 hardware detection uses the address burned into the adapter. To use another network address, type the network address in hexadecimal form, in the format XX-XX-XX-XX-XX-XX; for example, 01-02- |

03-4E-2D-1F.

Ring Speed

The ring speed is 4 or 16 megabits per second (MBS), and is set by changing a jumper on the adapter or by running the adapter's configuration utility. For example, for an Intel TokenExpress 16/4 adapter, this is set on the adapter itself. The value in Windows 95 should match the physical or software setting.

Setting LAN Adapter Numbers

NetBIOS defines the interface between the network client and the protocol layers using a set of function calls that allow an application to use the protocol services. Because many network applications use NetBIOS to send commands to the protocol driver, the NetBIOS interface is supported by all protocols provided with Windows 95.

Each combination of a NetBIOS network protocol and a network adapter forms a logical network over which computers can communicate with each other. For example, a computer can have a token-ring adapter and an Ethernet adapter, and might use NetBEUI on the token-ring network and both NetBEUI and TCP/IP on the Ethernet network. In this case, the computer is connected to three logical networks, each of which is assigned a NetBIOS LAN adapter (LANA) number that Windows 95 uses for communication.

When Windows 95 uses multiple protocols, it transmits data first using one protocol, then again using the next protocol, and so on. When multiple protocols are installed on a computer, the first protocol to be used is called the primary protocol.

On a computer running Windows 95, each binding of a protocol to a network adapter has a LAN adapter number assigned to it. (For example, one protocol bound to two network adapters requires two LAN adapter numbers; two protocols each bound to two adapters requires four LAN adapter numbers.)

In Windows 95, LANA numbers are assigned dynamically in sequence of binding order for the protocols, beginning with 7 and then 0, 1, and so on. This accommodates dynamic Plug and Play events such as removing a network adapter while the computer is running. If you are running Windows 95 in such a dynamic environment, Windows 95 cannot guarantee that a given protocol will receive the same LANA number each time the system is started. Although if the computer's network hardware never changes, the LANA numbers may not change at each startup. However, the default protocol is always LANA 0.

You need to change a LAN adapter number only if you have a NetBIOS application that needs to know the LANA number. For example, Lotus Notes® requires that you enter the LANA number that Lotus Notes will use. To configure Windows 95 to use Lotus Notes, set the default protocol to be the NetBIOS-based protocol on which you want to run Lotus Notes. (Setting the default protocol makes it LANA 0.) This protocol can be NetBEUI, IPX/SPX-compatible with NetBIOS support, or TCP/IP.



To select a default protocol for LANA settings

1. In the Network option in Control Panel, click the Configuration tab.
2. Double-click the protocol you want to be the default.
3. In the protocol's properties, click the Advanced tab.
4. Click the option named Set This Protocol To Be The Default Protocol so that the check box is checked. Then click OK, and shut down and restart the computer for the changes to take effect.

Technical Notes on Network Adapters

This section provides some technical notes for specific network adapters and briefly describes changes to network adapter driver support as compared to Windows for Workgroups 3.11.

NDIS 3.0 network adapter drivers that worked with Windows for Workgroups 3.11 do not work under Windows 95. You must use an NDIS 2.x real-mode driver, an ODI driver, or an updated NDIS 3.1 protected-mode driver for the network adapter. The driver must have a Windows 95 INF file. Many real-mode drivers, updated protected-mode drivers, and supporting INF files are included with Windows 95.

If the network adapter does not appear in the list of adapters in the Network option in Control Panel, you can use information for a Windows 3.x adapter to install it under Windows 95. If you have an OEMSETUP.INF file created for an earlier version of Windows, you can use that INF file by clicking Have Disk in the Select Network Adapter dialog box to install that older network adapter driver.

The major reason that the INF file format has changed for all types of Windows 95 network adapter drivers is that INF files are now used to add information to the Windows 95 Registry. The INF files created for earlier versions of Windows do not contain this kind of information.

IPX/SPX-Compatible Protocol

The Microsoft IPX/SPX-compatible protocol (NWLINK.VXD) supports the 32-bit Windows Sockets programming interface, so that any Win32-based Windows Socket application can run on IPX/SPX with Windows 95. (There are no 16-bit Windows Sockets applications using IPX/SPX.)

The IPX/SPX-compatible protocol can be used by Client for NetWare Networks to communicate with NetWare servers or computers running File and Printer Sharing for NetWare Networks.

This protocol can also be used by Client for Microsoft Networks to communicate with computers running Windows for Workgroups 3.11 or Windows NT that are running the same protocol.

The IPX/SPX-compatible protocol uses the NWNBLINK.VXD module to support computers that use NetBIOS over IPX and to support the NetBIOS programming interface. This protocol can also use NetWare servers configured as routers (and other IPX routers) to transfer packets across LANs.

Configuring IPX/SPX-Compatible Protocol

The Microsoft IPX/SPX-compatible protocol is installed automatically when Client for NetWare Networks is installed. You can also install this protocol to support other network clients, including Client for Microsoft Networks.

When you install the IPX/SPX-compatible protocol, Windows 95 automatically detects and sets appropriate values for the frame type, network address, and other settings. However, in some cases you might need to configure settings for this protocol manually.



To configure the IPX/SPX-compatible protocol

1. In the Network option in Control Panel, double-click IPX/SPX Compatible Protocol.
If the computer has multiple network adapters, the list will contain an instance of the IPX/SPX-compatible protocol for each network adapter. You must configure each adapter with its own settings.
2. Click the Advanced tab.

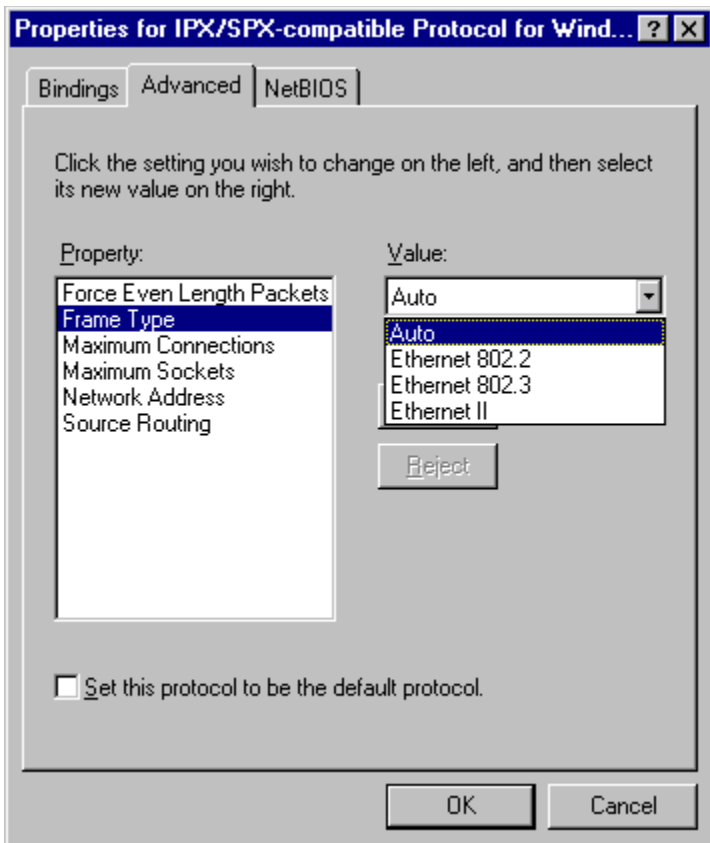

3. Most values have correct defaults in typical installations. If you need to change a value for a particular purpose, select the item in the Property list and specify a setting in the Value list based on the information in the following table.

Property	Value
Force even-length IPX packets	Enabled only for Ethernet 802.3 on monolithic implementations that cannot handle odd-length packets.
Frame type	Specifies the frame type based on detection. This value is used for network adapters that support

multiple frame types. The possible values are:

- Auto-detect (recommended)
- Ethernet 802.2 (default for NetWare 3.12 and later)
- Ethernet 802.3
- Ethernet II
- Token ring
- Token ring SNAP

Maximum connections	Specifies the maximum number of connections that IPX will allow. Configured dynamically.
Maximum sockets	Specifies the maximum number of IPX sockets that IPX assigns. Configured dynamically.
Network address	Specifies the IPX network address as a four-byte value. Configured dynamically.
Source routing ²	Specifies the cache size to use with source routing. This parameter is used only on token-ring networks, where it is used to turn on source routing. Important Cache size is specified by entry count, not byte count. The recommended value of 16 entries is the most efficient and best setting for most installations.

- ¹ Each time the computer starts, Windows 95 detects the frame type by sending a general RIP request in each frame format. Based on the responses received from routers, Windows 95 determines the most prevalent frame type used and sets that as the default frame type.
- ² Source routing is a method of routing data across bridges. For NetWare networks, this means forwarding NetWare frames across an IBM token-ring bridge. With NDIS protocols, source routing is done by the protocol. With ODI-based protocols, source routing is configured with the network adapter driver or using the NetWare ROUTE.COM utility.

You should not need to change bindings in most circumstances. However, you can disable the bindings for a protocol if you do not want other computers using that protocol to see this computer. At least one protocol, however, must be bound to the network client for the computer to communicate with the network.



To change bindings for the IPX/SPX-compatible protocol

1. In the properties for the IPX/SPX-compatible protocol, click the Bindings tab.
2. Click any network component to change its bindings.

If the option is checked, it is bound to the protocol. If it is not checked, that network component is not using the IPX/SPX-compatible protocol. For more information, see [Configuring Network Adapters](#).

Note Microsoft Client for NetWare Networks is always bound only to the IPX/SPX-Compatible Protocol. This network client cannot use another protocol.

Using NetBIOS over IPX

NetBIOS is an interface used by network applications to communicate with other NetBIOS-compliant applications. The NetBIOS interface is responsible for the following:

- Establishing logical names on the network
- Establishing connections (called sessions) between two computers by use of their logical names on the network
- Transmitting data between networked computers

Windows 95 provides a 32-bit, protected-mode driver to support NetBIOS services over IPX (VNETBIOS.386). This implementation is compatible with the Novell NetBIOS support driver. Performance enhancements include acknowledgment of previous frames in response frames (called PiggyBackAck), plus a "sliding window" acknowledgment mechanism.

These NetBIOS enhancements are used only when the computer is communicating with other computers using IPX over NetBIOS, such as other computers running Windows 95, Windows NT, or NetWare when running Lotus Notes or other NetBIOS applications. NetBIOS over IPX is not necessary for computers running Windows 95 to be able to communicate with each other. The redirector and server networking components in Windows 95 communicate with the IPX protocol directly without NetBIOS.

Novell provides a TSR NetBIOS driver named NETBIOS.EXE, which is a Level 1 NetBIOS provider that consumes about 40K of conventional memory. This driver acknowledges each frame received, thus increasing the amount of traffic generated when NetBIOS is used. With the Microsoft implementation of NetBIOS over IPX, you can remove the real-mode NETBIOS.EXE TSR.

Note A computer running Windows 95 that uses IPX without NetBIOS can connect to a Windows NT 3.5 server that uses IPX without NetBIOS. However, the Windows NT 3.5 workstation service (not Windows NT Workstation) can only connect to a computer running File and Printer Sharing for Microsoft Networks when the computer running Windows 95 is using NetBIOS over IPX.



To use the IPX/SPX-compatible protocol with NetBIOS on a computer

- In the properties for the IPX/SPX-compatible protocol, click the NetBIOS tab, and then click I Want To Enable NetBIOS Over IPX/SPX.

IPX/SPX Technical Notes on NetWare Networks

- There is no need to enable Source Routing on token-ring networks if the communication is on the same ring, even if one computer has it enabled.
- SPX-II is a protocol definition for windowing and transmitting large packets over SPX. You can run any SPX-II application under Windows 95 using the IPX/SPX-compatible protocol. The related Novell-supplied file TLI.DLL must be available on the computer to support SPX-II.
- The IPX/SPX-compatible protocol in Windows 95 uses NET.CFG parameters for NetBIOS over IPX on NetWare networks. However, it should not be necessary for you to configure these parameters, because most parameters are dynamic and self-adjusting. (When you install Windows 95 with protected-mode networking components, NET.CFG and SHELL.CFG parameters are moved to the Registry.)
- To determine the network address in IPX packets, Windows 95 checks the wire for RIP packets and chooses the most likely address. The network address is dynamic and changes when a new network address becomes more prevalent.
- All Transport Layer Interface (TLI) libraries can run on the IPX/SPX-compatible protocol in Windows 95. TLI is similar to TDI in Microsoft networking as a layer between the protocol and network adapter driver; this implementation is similar to STREAMS and provides a STREAMS environment for NetWare, but Windows 95 uses Windows Sockets instead.

TCP/IP Protocol

Microsoft TCP/IP provides communication across interconnected networks that use diverse hardware architectures and various operating systems. TCP/IP can be used to communicate with computers running Windows 95, with devices using other Microsoft networking products, or with non-Microsoft systems such as UNIX.

Microsoft TCP/IP provides all the following elements necessary for networking:

- Core TCP/IP protocols, including the Transmission Control Protocol (TCP), Internet Protocol (IP), User Datagram Protocol (UDP), Address Resolution Protocol (ARP), Internet Control Message Protocol (ICMP), and Domain Name Protocol (DNS). This suite of Internet protocols provides a set of standards for how computers communicate and how networks are interconnected.
- Support for application programming interfaces, including Windows Sockets and NetBIOS.
- TCP/IP diagnostic tools to detect and resolve TCP/IP networking problems, including **arp**, **ftp**, **nbtstat**, **netstat**, **ping**, **route**, and **tracert**, plus Windows-based Telnet and IP Configuration (WINIPCFG) utilities.

In addition, when you install Microsoft TCP/IP under Windows 95, the following enhancements are included:

- Client for DHCP, for automatic configuration of computers running TCP/IP on networks that have DHCP servers
- Client for WINS, for dynamic resolution of IP addresses to computer names on networks that have WINS servers
- Point-to-Point Protocol for asynchronous communication, as described in [Dial-Up Networking and Mobile Computing](#).

For a summary of the command-line options for TCP/IP utilities, see [Command-Line Commands Summary](#).

Configuring TCP/IP with DHCP

In an effort to make implementing the TCP/IP protocol more manageable, Microsoft worked with other industry leaders to create an Internet standard called Dynamic Host Configuration Protocol (DHCP) for the automatic allocation of IP addresses. DHCP is not a Microsoft standard, but a public Request for Comments (RFC 1541) that Microsoft has implemented.

DHCP allows you to establish a range of valid IP addresses to be used per subnetwork. An individual IP address from the range is assigned dynamically to any DHCP client requesting an address. DHCP also allows you to establish a lease time that defines how long an IP address is to remain valid. Other configuration parameters can also be assigned using DHCP, such as subnet mask, DNS and WINS server identification, and so on.

A computer running Windows 95 cannot be a DHCP server. A DHCP server runs as a service on a Windows NT 3.5 Server computer. If DHCP is available company-wide, users can move from subnet to subnet and always have a valid IP address. The IP Configuration utility (WINIPCFG) allows users or administrators to examine the current IP address assigned to the computer, the IP address lease time, and other useful data about the TCP/IP configuration.

When TCP/IP is installed, Windows 95 automatically enables the option to obtain an IP address from a DHCP server. This option can be disabled using the Network option in Control Panel if you want to enter an IP address manually.

If Microsoft TCP/IP is configured to obtain an IP address from a DHCP server when a DHCP server is not available on the network, the next time Windows 95 starts, an error message announces that the DHCP client could not obtain an IP address. To solve this problem, use the procedure described in the following section to configure TCP/IP manually.

Configuring TCP/IP Settings Manually

If you cannot use DHCP for automatic configuration, the network administrator must provide values so that individual users can configure TCP/IP manually. Or, if custom setup scripts are used to install Windows 95, the correct values can be defined in the setup script. The required values include the following:

- The IP address and subnet mask for each network adapter installed on the computer.
- The IP address for the default gateways (IP routers).
- Whether the computer will use Domain Name System (DNS) and, if so, the IP addresses of the DNS servers on the internetwork.
- WINS server addresses, if WINS servers are available on the network.

The following procedure describes the basic configuration options for TCP/IP. If you want to configure the computer to use WINS or DNS for name resolution, see the procedures in [Using WINS for Name Resolution](#) and [Using DNS for Name Resolution](#).



To configure the TCP/IP protocol manually

1. In the Network option in Control Panel, double-click Microsoft TCP/IP in the list of installed components.

Note If your computer has multiple network adapters, the list includes an instance of TCP/IP for each network adapter. You must configure each adapter with its own IP address, subnet mask, and gateway. All other settings apply system-wide.

2. In Microsoft TCP/IP properties, click the IP Address tab.

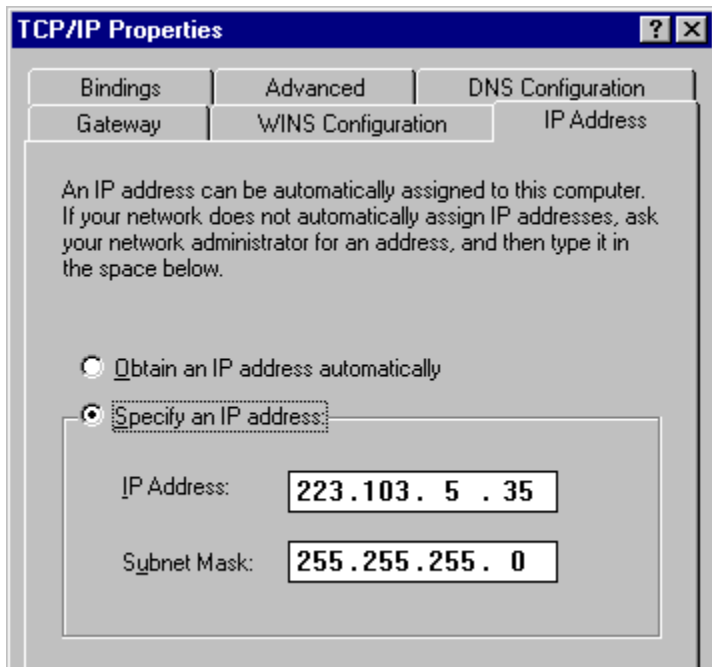

3. Click the option named Specify An IP Address.
4. Type an IP address and subnet mask in the respective boxes.

The network administrator must provide these values for individual users, based on the network ID and the host ID plan for your site.

- The value in the IP Address box identifies the IP address for the local computer or, if more than one network adapter is installed, for the network adapter selected in the Configuration dialog box.

- The value in the Subnet Mask box identifies the network membership and its host ID for the selected network adapter. The subnet mask defaults to an appropriate value, as shown in the following list.

Address class	Range of first octet in the IP address	Subnet mask
Class A	1–126	255.0.0.0
Class B	128–191	255.255.0.0
Class C	192–223	255.255.255.0

- To view or specify which network clients are bound to the TCP/IP protocol, click the Bindings tab.
 - To keep a network client from using the TCP/IP protocol, make sure the checkmark beside the client name is cleared.
 - If the network client for which you want to use TCP/IP does not appear in this list, that client might not be installed properly. Return to the Configuration dialog box and reinstall that network client.

Note The only network client provided with Windows 95 that can use Microsoft TCP/IP is Client for Microsoft Networks. Client for NetWare Networks does not use Microsoft TCP/IP.

NetWare/IP from Novell allows the NCP request to be sent over an IP header. You can use NetWare/IP only with a Novell-provided, real-mode client.

- Click the Gateway tab. Type at least one IP address for the default gateway (IP router) on the network, and then click Add.

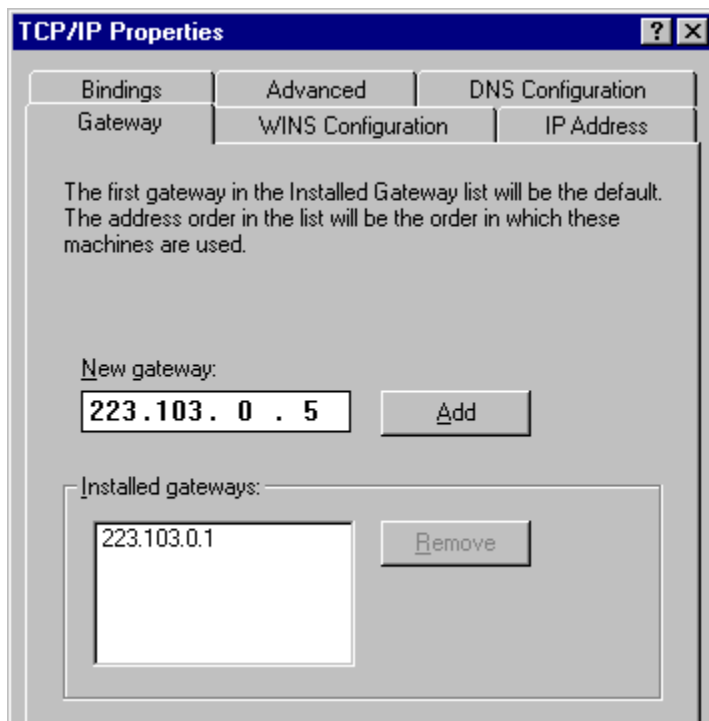

- To specify an IP address for an additional gateway, type the IP address in the New Gateway box, and then click the Add button.

The first gateway in the list is the default gateway. Gateway addresses can be prioritized by dragging the IP address in the list of installed gateways. Windows 95 attempts to connect to other gateways only if the primary gateway is unavailable.

- Click OK, and then restart the computer for changes to take effect.

If you are using Dial-Up Networking to connect to the Internet, you can manually configure DNS and IP addresses for each connection that you define. For more information about defining IP addresses for each connection and about IP addresses on TCP/IP networks, see [Internet Access](#).

Name Resolution for Windows Networking

For TCP/IP and the Internet, the globally known system name is the computer's host name, appended with a DNS domain name (for example, rhit.microsoft.com). This defaults to the computer name (NetBIOS name) defined during Windows 95 Setup. The default name can be changed in the DNS dialog box when you are configuring TCP/IP properties.

Computers use IP addresses to identify each other, but users usually find it easier to work with computer names. A mechanism must be available on a TCP/IP network to resolve names to IP addresses. To ensure that both the name and the address are unique, the computer using Microsoft TCP/IP registers its name and IP address on the network during system startup. Computers running Microsoft TCP/IP on the network can use one or more methods for name resolution in TCP/IP internetworks, as summarized in this section.

Broadcast name resolution.

Computers running Microsoft TCP/IP can use broadcast name resolution, which is a NetBIOS-over-TCP/IP mode of operation defined in RFC 1001/1002 as b-node. This method relies on a computer making IP-level broadcasts to register its name by announcing it on the network. Each computer in the broadcast area is responsible for challenging attempts to register a duplicate name and for responding to name queries for its registered name.

LMHOSTS or HOSTS files.

An LMHOSTS file specifies the NetBIOS computer name and IP address mappings; a HOSTS file specifies the DNS name and IP address. On a local computer, the HOSTS file (used by Windows Sockets applications to find TCP/IP host names) and LMHOSTS file (used by NetBIOS over TCP/IP to find NetBIOS computer names) can be used to list known IP addresses mapped with corresponding computer names. LMHOSTS is used for name resolution in Windows 95 for internetworks where WINS is not available.

- The HOSTS file is used as a local DNS equivalent to resolve host names to IP addresses.
- The LMHOSTS file is used as a local WINS equivalent to resolve NetBIOS computer names to IP addresses.

Each of these files is also known as a *host table*. Sample versions of LMHOSTS (called LMHOSTS.SAM) and HOSTS files are added to the Windows directory when you install Windows 95 with TCP/IP support. These files can be edited using any ASCII editor, such as WordPad or Edit. To take advantage of HOSTS or LMHOSTS, DNS must be enabled on the computer. For information about setting up and using HOSTS and LMHOSTS files, see [HOSTS and LMHOSTS Files for Windows 95](#).

Windows Internet Naming Service.

Computers running Microsoft TCP/IP can use WINS if one or more Windows NT Server computers configured as WINS servers are available, containing a dynamic database for mapping computer names to IP addresses. WINS can be used in conjunction with broadcast name resolution for an internetwork, where other name resolution methods are inadequate. WINS is a NetBIOS-over-TCP/IP mode of operation defined in RFC 1001/1002 as h-node or m-node; WINS clients default to h-node. Notice that WINS is a dynamic replacement for the LMHOSTS file. For more information, see [Using WINS for Name Resolution](#).

Domain Name System name resolution.

DNS provides a way to look up name mappings when connecting a computer to foreign hosts using NetBIOS over TCP/IP or Windows Sockets applications such as FTP. DNS is a distributed database designed to relieve the traffic problems that arose with the first growth explosion on the Internet in the early 1980s. A DNS name server must be configured and available on the network. Notice that DNS replaces the functionality of the HOSTS file by providing a dynamic mapping of IP addresses to host names used by TCP/IP applications and utilities. For more information, see [Using DNS for Name Resolution](#).

Windows 95 provides support for multiple DNS servers and up to two WINS servers. Support for either service can be configured automatically from a DHCP server, manually in Windows 95 Setup, or after Setup by using the Network option in Control Panel.

Using WINS for Name Resolution

WINS provides a distributed database for registering and querying dynamic computer name-to-IP address mappings in a routed network environment. If you are administering a routed network that includes computers running Windows NT Server, WINS is your best choice for name resolution, because it is designed to solve the problems that occur with name resolution in more complex internetworks.

WINS reduces the use of local broadcasts for name resolution and allows users to locate computers on remote networks automatically. Furthermore, when dynamic addressing through DHCP results in new IP addresses for computers that move between subnetworks, the changes are updated automatically in the WINS database. Neither the user nor the network administrator needs to make manual accommodations for name resolution in such a case.

The WINS protocol is based on and is compatible with the protocol defined for WINS server in Requests for Comments (RFCs) 1001 and 1002, so it is interoperable with any other implementations of these RFCs. WINS consists of two components: the WINS server, which handles name queries and registrations, and the client software (NetBIOS over TCP/IP), which queries for computer name resolution. A WINS server is a Windows NT Server 3.5 computer with WINS server software installed. When Microsoft TCP/IP is installed under Windows 95, WINS client software is installed automatically.

Windows networking clients that are WINS-enabled can use WINS directly. Non-WINS computers on the internetwork that are b-node-compatible, as described in RFCs 1001 and 1002, can access WINS through proxies, which are WINS-enabled computers that listen to name query broadcasts and then respond for names that are not on the local subnet or are h-nodes.

On a Windows network, users can browse transparently across routers. To allow browsing without WINS, you must ensure that the users' primary domain has Windows NT Server computers on both sides of the router to act as master browsers. These computers need to contain correctly configured LMHOSTS files with entries for the domain controllers across the subnet.

With WINS, such strategies are not necessary, because the WINS servers and proxies provide the support necessary for browsing Windows NT domains across routers. For a technical discussion of how WINS works and how it can be set up on the network, see *Windows NT Server 3.5 TCP/IP* in the Windows NT Server 3.5 documentation set.

If there are WINS servers installed on your network, you can use WINS in combination with broadcast name queries to resolve NetBIOS computer names to IP addresses. If you do not use this option, Windows 95 can use name query broadcasts (b-node mode of NetBIOS over TCP/IP) plus the local LMHOSTS file to resolve computer names to IP addresses. Broadcast resolution is limited to the local network, as described earlier in this section.

If DHCP is used for automatic configuration, these parameters can be provided by the DHCP server. Otherwise, you must configure information about WINS servers manually. WINS configuration is global for all network adapters on a computer.

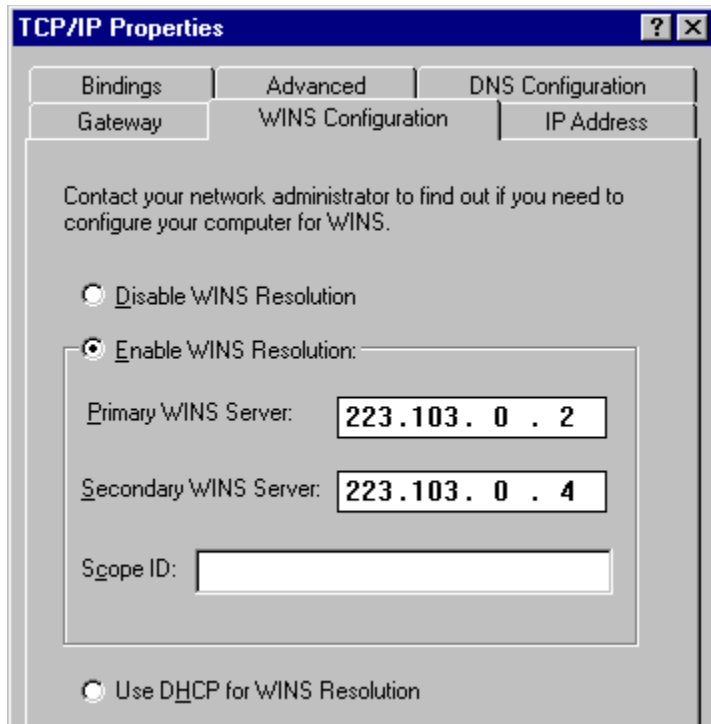

To configure a computer to use WINS for name resolution

1. In the Microsoft TCP/IP properties, click the WINS Configuration tab.
2. If a DHCP server is available that is configured to provide information on available WINS servers, select Use DHCP For WINS Resolution.
– Or –
If a WINS server is available but not a DHCP server, select Enable WINS Resolution and type the IP addresses of the Primary and Secondary WINS servers. These values should be provided by the network administrator, based on the IP addresses assigned to these Windows NT Server computers.
3. If WINS is enabled, in the Scope ID box, type the computer's scope identifier, if required on an internetwork that uses NetBIOS over TCP/IP.
Usually this value is left blank. Scope IDs are used only for communication based on NetBIOS over TCP/IP. In such a case, all computers on a TCP/IP internetwork must have the same scope ID. A scope ID can be assigned to a group of computers if those computers communicate only with each other and not with computers outside the group. Such computers can find each other if their scope IDs are identical.

Using DNS for Name Resolution

DNS provides a distributed database that contains a hierarchical naming system for identifying hosts on the Internet. The specifications for DNS are defined in Requests for Comments (RFCs) 1034 and 1035.

Although DNS may seem similar to WINS, there is one major difference: DNS requires static configuration of IP addresses for name-to-address mapping. WINS can provide name-to-address mapping dynamically and requires far less administration.

The DNS database is a tree structure called the domain name space, where each node or domain is named and can contain subdomains. The domain name identifies the domain's position in the database in relation to its parent domain, with a period (.) separating each part of the name for the network nodes of the DNS domain.

The root of the DNS database is managed by the Internet Network Information Center. The top-level domains were assigned organizationally and by country. These domain names follow the International Standard 3166. Two-letter and three-letter abbreviations are used for countries, and various abbreviations are reserved for use by organizations, as shown in the following example.

DNS domain name	Type of organization
com	Commercial (for example, microsoft.com)
edu	Educational (for example, mit.edu for Massachusetts Institute of Technology)
gov	Government (for example, nsf.gov for the National Science Foundation)
org	Noncommercial organizations (for example, fidonet.org for FidoNet)
net	Networking organizations (for example, nsf.net for NSFNET)

DNS uses a client-server model, where the DNS servers contain information about a portion of the DNS database and make this information available to clients, called *resolvers*, that query the name server across the network. DNS *name servers* are programs that store information about parts of the domain name space called *zones*. The administrator for a domain sets up name servers that contain the database files with all the resource records describing all hosts in their zones. DNS resolvers are clients that are trying to use name servers to gain information about the domain name space.

All the resolver software necessary for using DNS on the Internet is installed with Microsoft TCP/IP. Microsoft TCP/IP includes the DNS resolver functionality used by NetBIOS over TCP/IP and Windows Sockets connectivity applications such as FTP and Telnet to query the name server and interpret the responses.

The key task for DNS is to present friendly names for users and then resolve those names to IP addresses, as required by the internetwork. If a local name server doesn't contain the data requested in a query, it sends back names and addresses of other name servers that could contain the information. The resolver then queries the other name servers until it finds the specific name and address it needs. This process is made faster because name servers continuously cache the information learned about the domain name space as the result of queries.

Although TCP/IP uses IP addresses to identify and reach computers, users typically prefer to use host names. DNS is a naming service generally used in the UNIX networking community to provide standard naming conventions for IP workstations. TCP/IP utilities, such as FTP and Telnet, can also use DNS in addition to the HOSTS file to find computers, when connecting to foreign hosts or computers on your network.

You need to determine whether users should configure their computers to use DNS. Usually you will use DNS if you are using TCP/IP to communicate over the Internet or if your private internetwork uses DNS to distribute host information.

Microsoft TCP/IP provides a DNS client for resolving Internet or UNIX system names. Windows networking provides dynamic name resolution for NetBIOS computer names using WINS servers and NetBIOS over TCP/IP, as described in the previous section.

If you choose to use DNS, you must configure how the computer will use DNS and the HOSTS file. DNS configuration is global for all network adapters installed on a computer. If DHCP is used for automatic configuration, these parameters can be provided by the DHCP server.

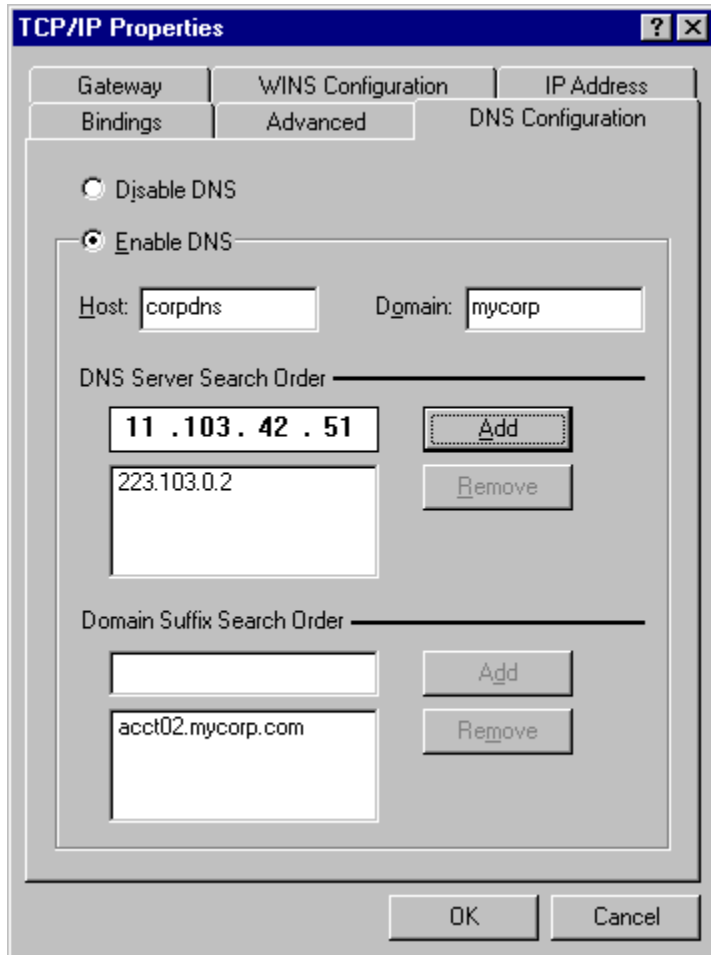

■ **To configure a computer to use DNS for name resolution**

1. In the Microsoft TCP/IP properties, click the DNS Configuration tab.
2. If a DNS server is available, click Enable DNS. Then specify a host name and complete the other configuration information as described in the following procedure.

Tip You must enable DNS on each computer that needs to use LMHOSTS for name resolution.

The host name is used to identify the local computer for authentication by some utilities. Other TCP/IP-based utilities can use this value to learn the name of the local computer. Host names are stored on DNS servers in a table that maps names to IP addresses for use by DNS.

■ **To set the host name for DNS**

- Type a name in the Host Name box.

The name can be any combination of the letters A through Z, the numerals 0 through 9, and the hyphen (-), plus the period (.) character used as a separator. By default, this value is the Microsoft networking computer name, but the network administrator can assign another host name without

affecting the computer name.

Note Some characters that can be used in computer names, especially the underscore, cannot be used in host names.

The TCP Domain Name is used with the host name to create a fully qualified domain name (FQDN) for the computer. The FQDN is the host name followed by a period (.), followed by the domain name. For example, this could be **johndoe.microsoft.com**, where **johndoe** is the host name and **microsoft.com** is the domain name.

During DNS queries, the local domain name is appended to short names. A short name consists of only a host name, such as **janedoe**. When querying the DNS server for the IP address of **janedoe**, the domain name is appended to the short name, and the DNS server is actually asked to resolve the FQDN of **janedoe.microsoft.com**. Notice that the FQDN of Jane Doe at Microsoft (**janedoe.microsoft.com**) is not the same as her Internet electronic mail address of **janedoe@microsoft.com**.



To set the DNS domain name

- Optionally, type a name in the Domain Name box.

This is usually an organization name followed by a period and an extension that indicates the type of organization, such as **microsoft.com**. The name can be any combination of the letters A through Z, the numerals 0 through 9, and the hyphen (-), plus the period (.) character used as a separator.

Note A DNS domain is not the same as a Windows NT or LAN Manager domain. A DNS domain is a hierarchical structure for organizing TCP/IP hosts and provides a naming scheme used in UNIX environments. A Windows NT or LAN Manager domain is a grouping of computers for security and administrative purposes.

You can add up to three IP addresses for DNS servers. For a given DNS query, Windows 95 attempts to get DNS information from the first IP address in the list. If no response is received, Windows 95 goes to the second server in the list, and so on. To change the order of the IP addresses, you must remove them and retype them in the order that you want the servers to be searched.



To set the DNS server search order

1. In the Domain Name System (DNS) Search Order box, type the IP address of a DNS server that will provide name resolution. Then click the Add button to add the IP address to the list.

The network administrator should provide the correct values for this parameter, based on the IP address assigned to the DNS server used at your site.

2. To remove an IP address from the list, select it, and then click the Remove button.

Note If you have two servers listed in this dialog box, Windows 95 checks the second server only if no response is received from the first server. If Windows 95 attempts to check a host name with the first server and receives a message that the host name is not recognized, the system does not try the second DNS server.

The Domain Suffix Search Order specifies the DNS domain suffixes to be appended to host names during name resolution. You can add up to five domain suffixes. Domain suffixes are placed in the list in alphabetic order.



To set the domain suffix search order

1. In the Domain Suffix Search Order box, type the domain suffixes to add to your domain suffix search list, and then click the Add button.

2. To remove a domain name from the list, select it, and then click the Remove button.

When attempting to resolve a fully qualified domain name (FQDN) from a short name, Windows 95 will first append the local domain name. If this is not successful, Windows 95 will use the Domain Suffix list to create additional FQDNs and query DNS servers in the order listed.

Network Technical Discussion

TCP/IP Protocol

Microsoft TCP/IP Registry Parameters

This section describes additional Registry settings that can be modified for Microsoft TCP/IP. Other TCP/IP settings should be changed only by using the Network option in Control Panel.

Each parameter must be added to the correct key. For information about how to add entries in the Registry, see [Windows 95 Registry](#).

Network Technical Discussion

TCP/IP Protocol

Microsoft TCP/IP Registry Parameters

TCP/IP Registry Entries in the MSTCP Subkey

The entries described here must be added to the following Registry key:

Hkey_Local_Machine\System\CurrentControlSet\Services\VxD\MSTCP

BroadcastAddress = *broadcast address in hexadecimal*

Specifies the address to use for NetBIOS name query broadcasts. The default is based on the IP address and the subnet mask.

BcastNameQueryCount = *integer*

Specifies the number of times the system will retry NetBIOS name query broadcasts. The default is 3.

BcastQueryTimeout = *milliseconds*

Specifies the period of time the system will wait before timing out broadcast name queries. The minimum value is 100. The default is 750.

BSDUrgent = *0 or 1*

If this value is 1, specifies that Microsoft TCP/IP is to treat urgent data the way some UNIX systems do (with a maximum of 1 byte of urgent data, for example). If this value is 0, it specifies that the stack is to handle urgent data as specified by RFC 1122. The default is 1.

CacheTimeout = *milliseconds*

Specifies how long NetBIOS names are cached. The minimum is 60000 milliseconds (1 minute). The default is 360000 milliseconds (6 minutes).

DeadGWDetect = *0 or 1*

Specifies whether Microsoft TCP/IP will use another gateway if the current default gateway seems to be down. The default is 1.

DefaultRcvWindow = *16-bit number*

Specifies the default receive window advertised by TCP. The default is 8192.

DefaultTOS = *8-bit number*

Specifies the default type of service (TOS) for IP packets initiated by Microsoft TCP/IP. The default is 0.

DefaultTTL = *8-bit number*

Specifies the default time to live (TTL) for IP packets from Microsoft TCP/IP. The default is 32.

DnsServerPort = *port*

Specifies which DNS server port to send queries to when resolving a name using DNS. The default is 53.

EnableProxy = *0 or 1*

If this value is 1, specifies that this computer is a WINS proxy agent. The default is 0.

EnableRouting = *0 or 1*

Specifies whether to enable static routing. Microsoft TCP/IP does not supply a routing protocol, so all route table entries must be entered using the **route** command. The default is 0.

IGMPLevel = *0, 1, or 2*

Specifies the level of support allowed for IP multicast, corresponding to the levels in RFC 1112. The default is 2.

InitialRefreshT.O. = *milliseconds*

Specifies the interval over which to contact WINS to refresh the name. The minimum is 16 minutes, and the maximum is approximately 50 days (0xFFFFFFFF). The default is 960000 milliseconds (16 minutes).

KeepAliveTime = *32-bit number*

Specifies the connection idle time in milliseconds before TCP will begin sending keepalives, if keepalives are enabled on a connection. The default is 2 hours (7200000).

KeepAliveInterval = *32-bit number*

Specifies the time in milliseconds between retransmissions of keepalives, once the **KeepAliveTime** has expired. Once **KeepAliveTime** has expired, keepalives are sent every **KeepAliveInterval** milliseconds until a response is received, up to a maximum of **MaxDataRetries** before the connection is aborted. The default is 1 second (1000).

LmhostsTimeout = *milliseconds*

Specifies the period of time the system will wait before timing out when seeking LMHOSTS for name resolution. The minimum value is 1000 (1 second). The default is 10000 (10 seconds).

MaxConnections = *32-bit number*

Specifies the maximum number of concurrent connections. The default is 100.

MaxConnectRetries = *32-bit number*

Specifies the number of times a connection attempt (SYN) will be retransmitted before giving up. The initial retransmission timeout is 3 seconds, and it is doubled each time up to a maximum of 2 minutes. The default is 3.

MaxDataRetries = *32-bit number*

Specifies the maximum number of times a segment carrying data or an FIN will be retransmitted before the connection is aborted. The retransmission timeout itself is adaptive and will vary according to link conditions. The default is 5.

NameServerPort = *port*

Specifies the UDP port on the name server to which to send name queries or registrations. The default is 137.

NameSrvQueryCount = *integer*

Specifies the number of times the system will try to contact the WINS server for NetBIOS name resolution. The default is 3.

NameSrvQueryTimeout = *milliseconds*

Specifies how long the system waits before timing out a name server query. The minimum is 100. The default is 750.

NameTableSize = *integer*

Specifies the maximum number of names in the NetBIOS name table. The minimum allowable value is 1 and the maximum is 255. The default is 17.

NodeType = *1, 2, 4, or 8*

Specifies the mode of NetBIOS name resolution used by NetBIOS over TCP/IP, where 1 = b-node, 2 = p-node, 4 = m-node, and 8 = h-node. This value can be configured using DHCP. The default is 1 (b-node), if no value is specified; if WINS servers are specified and **NodeType** is not, then the default is 8 (h-node).

PMTUBlackHoleDetect = *0 or 1*

Specifies whether the stack will attempt to detect Maximum Transmission Unit (MTU) routers that do not send back ICMP fragmentation-needed messages. Setting this parameter when it is not needed can cause performance degradation. The default is 0.

PMTUDiscovery = *0 or 1*

Specifies whether Microsoft TCP/IP will attempt to do path MTU discovery as specified in RFC 1191. The default is 1.

RandomAdapter = *0 or 1*

For a computer with multiple network adapters, specifies whether to respond with an IP address selected randomly from the set of addresses on the computer or whether to return the IP address of the adapter that the request came in upon. The default is 0 (not random; that is, return the address of the adapter that the request came in on).

RoutingBufSize = *32-bit number*

Specifies the total amount of buffer space to allocate for routing packets. This parameter is ignored if **EnableRouting=0**. The default is 73216.

RoutingPackets = *32-bit number*

Specifies the maximum number of packets that can be routed simultaneously. This parameter is ignored if **EnableRouting=0**. The default is 50.

SessionKeepAlive = *milliseconds*

Specifies how often to send session keepalive packets on active sessions. The minimum is 60

seconds. The default is 3600 seconds (1 hour).

SessionTableSize = *integer*

Specifies the maximum number of sessions in the NetBIOS session table. The minimum allowable value is 1 and the maximum is 255. The default is 255.

SingleResponse = *0 or 1*

For a computer with multiple network adapters, specifies whether to send all IP addresses on a name query request from WINS. If this value is 1, the system will send one address in a name query response; if 0, it will return all the addresses of its adapters. The default is 0.

Size/Small/Medium/Large = *1, 2, or 3*

Specifies how many buffers of various types to preallocate and the maximum that can be allocated, where 1 = small, 2 = medium, and 3 = large. The default is 1; the default is 3 if the WINS proxy is enabled.

Network Technical Discussion

TCP/IP Protocol

Microsoft TCP/IP Registry Parameters

TCP/IP Registry Entries in the MSTCPSubkey

This section describes variables for subkeys that appear in the following Registry key:

```
Hkey_Local_Machine\System\CurrentControlSet\Services\VxD  
  \MSTCP\ServiceProvider
```

The following keys describe the order used to resolve host names. A lower number sets a higher priority for name resolution. These settings are used for 16-bit Windows Sockets, which need to rely on the resolvers that are expected to take the least time. The numbers indicate the default values specified in Windows 95.

LocalPriority = 499

HostsPriority = 500

DNSPriority = 2000

NetbtPriority = 2001

Network Technical Discussion

TCP/IP Protocol

Microsoft TCP/IP Registry Parameters

TCP/IP Registry Entries in the NetTrans Subkey

The entries in this section must be added to the following Registry key, where *n* represents the particular TCP/IP-to-network adapter binding.

```
Hkey_Local_Machine\System\CurrentControlSet\Services\Class\netTrans\000n
```

MaxMTU = 16-bit integer

Specifies the maximum size datagram IP that can pass to a media driver. SNAP and source routing headers (if used on the media) are not included in this value. For example, on an ethernet network, **MaxMTU** will default to 1500. The actual value used will be the minimum of the value specified with this parameter and the size reported by the media driver. The default is the size reported by the media driver.

Microsoft NetBEUI Protocol

Windows 95 provides the NetBIOS extended user interface (NetBEUI) protocol for compatibility with existing networks that use NetBEUI. Because NetBEUI is nonroutable and was designed for smaller LANs, you should use the TCP/IP or IPX/SPX-compatible protocol for enterprise-wide networks that require a routable protocol.

NetBEUI in Windows 95 supports a NetBIOS programming interface that conforms to the IBM NetBEUI specifications and includes several performance enhancements. The NetBEUI module, NETBEUI.VXD, is accessible through the NetBIOS interface.

If Windows 95 Setup detects NetBEUI during installation, it installs support for Microsoft NetBEUI automatically. You can add this protocol at any time. The Advanced properties for NetBEUI affect only real-mode NetBEUI. These values are set dynamically for protected-mode NetBEUI.



To configure real-mode NetBEUI manually

1. In the Network option in Control Panel, click the Configuration tab. Then double-click Microsoft NetBEUI.

If your computer has multiple network adapters, an instance of NetBEUI appears for each network adapter. You must configure each adapter with its own settings.

The Bindings tab shows which clients and services are currently using the NetBEUI protocol. For information about configuring bindings, see [Configuring Network Adapters](#).

2. Click the Advanced tab to modify settings for Maximum Sessions and NCBS for the real-mode NetBEUI.

Option	Description
Maximum Sessions	Used to identify the maximum number of connections to remote computers that can be supported from the redirector. This is equivalent to the sessions= parameter formerly specified in PROTOCOL.INI.
NCBS (network control blocks)	Used to identify the maximum number of NetBIOS commands that can be used. This is equivalent to the ncbs= parameter formerly specified in PROTOCOL.INI.

3. Click OK. Then shut down and restart the computer.

Using WinPopup to Broadcast a Pop-Up Message

You can use WinPopup to send a message to one person or to a whole workgroup. WinPopup can also display a message from someone else on your network or from a printer when your print job is done. With WinPopup, you can send and receive messages and alerts from LAN Manager, Windows for Workgroups, Windows NT, and Windows 95 servers and clients.

On a NetWare network, you can also use WinPopup to send messages in the following cases:

- If you are running a NetWare-compatible client, you can receive pop-up messages from the server you are attached to. You can also receive messages from other users running Novell-supplied network clients if the message is sent to you on the server using NetWare utilities.
- You can use WinPopup to send a message to a user on a computer running Client for NetWare Networks or a Novell-supplied client if that user is attached to your preferred server.
- If you are running both Client for NetWare Networks and Client for Microsoft Networks, and if the message reaches the specified computer or user through Windows 95 networking, the message is not also sent through the NetWare server.

WinPopup is installed automatically with either Microsoft Client for NetWare Networks or Client for Microsoft Networks.



To configure WinPopup on a client computer

1. Place WINPOPUP.EXE in the Startup folder on each computer that you want to receive messages.
2. On each computer, click the Messages Menu, and then click Options to specify choices for how WinPopup will present messages.

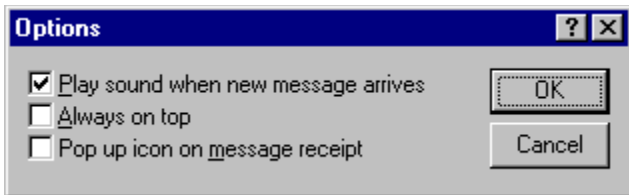

To send a message using WinPopup

1. Click the Send button on the toolbar. Or, from the Messages menu, click Send.
2. Click an option to specify whether to send the message to a specific user or computer or to a workgroup. Then type the name for where the message is to be sent.
3. Type a message, and then click OK.



As an example of how this might be used in a workgroup, you might want to run WinPopup on a computer running File and Printer Sharing services. Every computer in the workgroup that uses shared resources on this computer can also run WinPopup. On each client computer, WinPopup can report messages from the printer (such as notification that a print job has been completed). Or administrators can send messages to users and computers in the workgroup with pop-up notification.

To remove WinPopup from a computer, use the Add/Remove Programs option in Control Panel.

Troubleshooting Protocol Problems

This section contains information about troubleshooting problems related to network protocols. For general information about troubleshooting the network installation, including how to use **net diag**, see [Introduction to Windows 95 Networking](#). For information about troubleshooting procedures and tools provided with Windows 95, see [General Troubleshooting](#).

You cannot connect using NetBEUI.

- Use **net diag** to test for NetBIOS connectivity over the LANA that NetBEUI is using. If it fails, check the transceiver type, cabling, and adapter.
- Check the NetBEUI protocol bindings.
- Verify that routing is not involved.

A NetBIOS application fails to start.

This might be because the application is hard-coded to use the protocol on LANA 0 (such as Lotus Notes). You can force a particular protocol to always occupy LANA 0 by selecting it as the default protocol, as described in [Setting LAN Adapter Numbers](#).

You cannot connect using the IPX/SPX-compatible protocol.

Verify that both computers trying to connect are using the same frame type and that other settings are correct for this protocol.

- Verify the following in the Advanced properties for this protocol, as described in [Configuring IPX/SPX-Compatible Protocol](#):
 - The correct Frame Type is set. The recommended setting is Auto, but this frame type only checks SAP broadcast traffic on the network and might be selecting an incorrect frame type in a mixed frame-type environment.
 - Source Routing is enabled and a cache size is set if needed.
 - The option named Force Even Length Packets is set properly. NetWare servers with older NetWare Ethernet drivers or older IPX routers may require even-sized packets. If required, change this setting to make sure the computer transmits only even-length IPX frames.
- On the IPX routers, check the setting for Type 20 Packets (NetBIOS packets). When using NetBIOS over IPX, the IPX packet type is set to 14h (decimal 20). Manufacturers of routers might consider all NetBIOS traffic as being nonroutable LAN traffic even when carried over the routable IPX protocol, and so, by default, will not pass Type 20 NetBIOS IPX packets. To use NetBIOS over IPX connectivity, Type 20 packet passing must be enabled on the router.
- Use **net diag** to test for IPX connectivity over the related LANA number used by NetBIOS over IPX.
- Use System Monitor to view statistics for the IPX/SPX-compatible protocol. Then retry network operation and check the activity. If there is none, remove and reinstall the protocol, and then retry and retest the operation.

You cannot connect using TCP/IP.

Use the TCP/IP diagnostic utilities included with Microsoft TCP/IP to isolate network hardware problems and incompatible configurations. The following list describes which utility helps to identify various problems.

Use this utility To accomplish this action

ping	Check host name, host IP address, and TCP/IP configuration; verify physical connection and remote TCP/IP computer
arp	Detect invalid entries in the ARP table on the local computer
nbtstat	Check the state of NetBIOS over TCP/IP connections, update LMHOSTS cache, and determine registered name and scope ID
netstat	Display statistics and state of current TCP/IP connections
tracert	Check the route to a remote computer

You can also use the IP Configuration utility (WINIPCFG) to display, update, or release TCP/IP configuration values.



To test TCP/IP using ping

- Check the loopback address by typing **ping 127.0.0.1** and pressing ENTER at the command prompt. The computer should respond immediately. (If you are using DHCP, use the IP Configuration utility to find the IP address.) To determine whether you configured IP properly, use **ping** with the IP address of your computer, your default gateway, and a remote host.

If you cannot use **ping** successfully at any point, verify the following:

- The computer was restarted after TCP/IP was installed and configured.
- The local computer's IP address is valid and appears correctly in the TCP/IP Properties dialog box.
- The IP address of the default gateway and remote host are correct.
- IP routing is enabled on the router, and the link between routers is operational.
- The local computer's Registry includes an entry for **lmhosts=c:\directory** that correctly indicates the location of LMHOSTS.

If you can use **ping** to connect to other computers running Windows 95 on a different subnetwork but cannot connect using Windows Explorer or **net use \\server\share**, verify the following:

- The correct host computer name was used.
- The target host uses NetBIOS. If not, you must use FTP or Telnet to make a connection, and the target host must be configured with the FTP server daemon or Telnet daemon, and you must have correct permissions on the target host.
- The scope ID on the target host is the same as the local computer.
- A router path exists between your computer and the target computer.
- LMHOSTS contains correct entries, so the computer name can be resolved.
- The computer is configured to use WINS, the WINS server addresses are correct, and WINS servers are functioning.

The "Unable to connect to a server" message appears.

This message appears if name resolution fails for a particular computer name. If the computer is on the local subnetwork, confirm that the target server name is spelled correctly and that the target server is running TCP/IP. If the computer is not on the local subnetwork, be sure that its name and IP address mapping are available in the LMHOSTS file or the WINS database. If all TCP/IP elements appear to be installed properly, use **ping** with the remote computer to be sure that its TCP/IP software is working.

Use the **nbtstat -n** command to determine what name (or names) the server registered on the network. The **nbtstat** command can also display the cached entries for remote computers from either #PRE entries in LMHOSTS or recently resolved names. If the remote computers are using the same name for the server, and the other computers are on a remote subnetwork, be sure that they have the computer's mapping in their LMHOSTS files.

IP address connects but host names do not.

Verify that the HOSTS file and DNS settings have been configured for the computer by checking settings on the DNS Configuration tab.

- If you are using a HOSTS file, verify that the DNS host name of the remote computer is identical — especially in terms of spelling and capitalization — to the name in the file and the application using it.
- If you are using DNS, verify that the IP addresses of the DNS servers are correct and in proper order. Use **ping** with the remote computer, and type both the host name and IP address to determine if the host name is resolved properly.

Use the **netstat -a** command to show the status of all activity on TCP and UDP ports on the local computer. A good TCP connection is usually established with 0 bytes in the send and receive queues. If data is blocked in either queue or if the state is irregular, there might be a problem with the connection. If not, you are probably experiencing network or application delays.

Connect times are long after adding to LMHOSTS.

You might experience long connect times with a large LMHOSTS file if there is an entry at the end of

the file. If so, mark the entry in LMHOSTS as a preloaded entry by following the mapping with the #PRE tag, or place the mapping higher in the LMHOSTS file. Then use the **nbtstat -R** command to update the local name cache immediately. The LMHOSTS file is parsed sequentially to locate entries without the #PRE keyword. You should place frequently used entries near the top of the file, and place the #PRE entries near the bottom.

System Management

This part of the *Windows 95 Resource Kit* contains the following chapters, describing system management of individual and network computers running Windows 95.

Chapter 13 Introduction to System Management

Describes how user profiles, system policies, remote administration, and network backup functionality make it easier for administrators to manage corporate networks. This chapter also describes where to find system management tools to use with Windows 95.

Chapter 14 Security

Describes the security features of Windows 95, including security for network and system logon, and security for shared resources on computers running Windows 95. It also describes options for using password caching, and describes Windows 95 security for remote administration.

Chapter 15 User Profiles and System Policies

Describes how to use user profiles to define desktop preferences and application settings for individuals. This chapter also describes how to use system policies to control what users can and cannot do on the desktop and the network.

Chapter 16 Remote Administration

Describes the Windows 95 management features that allow you to manage network computers from your own computer. This chapter also includes information about administration applications and network backup agents from other vendors to support network administrators in the corporate enterprise.

Chapter 17 Performance Tuning

Describes how the built-in features for Windows 95 manage memory and ensure peak performance from hardware, software, and the network. This chapter describes how to use tools for configuring swap files and the file system, and how to use System Monitor to monitor performance in Windows 95.

Introduction

The Windows 95 system architecture supports security and centralized system management for configuring remote computers on the network. This chapter summarizes the features that support system management in Windows 95.

- System Management with Windows 95
- Sources for Windows 95 System Management Tools

System Management with Windows 95

The system management tools and agents provided with Windows 95 support system management for three management areas:

- Operating system software, including drivers, system services, and user interface components. These require system software distribution, system and user configuration management, security, and data backup.
- Hardware, including the computer's motherboard, add-in cards, hard disk and CD-ROM drives, monitors, tape drives, pointing devices, and keyboards.
- Application software that must be licensed and installed.

Windows 95 provides Registry-based support for remote management of configuration settings for hardware and software settings — either on individual computers or (through system policies) on multiple computers on the network. In addition, the Windows 95 compact disc includes agents for remote system administration using other management software.

The following summarizes the important features in Windows 95 that support system management on corporate networks.

Security for system logon and resource access.

The administrator can take advantage of centralized user accounts on Windows NT or Novell® NetWare® networks to restrict network logon and access to shared resources on computers running Windows 95. Windows 95 provides password caching to make it easier for users to manage connections to password-protected resources, yet also allows network administrators to restrict users' capabilities and, consequently, enforce strict security policies. For information, see [Security](#).

User profiles.

When user profiles are enabled, individual users, desktop configurations are available wherever they log on to the network. This solution permits multiple users to share one computer and "roving" users to log on to other networked computers while maintaining their personal settings. Administrators can also enforce a "mandatory" user profile, which can be useful for managing a common desktop for novice users. For information, see [User Profiles and System Policies](#).

System policies.

The administrator can use system policies to specify required system settings and to restrict network access, security privileges, and system settings from a convenient central source. Policies can be specified for groups, for specific users, and for multiple computers, providing administrators significant control over users' ability to configure computer and desktop settings. For information, see [User Profiles and System Policies](#).

Remote administration.

Built-in capabilities for remote administration assist administrators in managing networking computers from a central location, reducing the burden of supporting system configuration and troubleshooting on the corporate network. For information, see [Remote Administration](#).

Backup capabilities.

Backup agents used with Windows 95 support network-based data backup without requiring user intervention. Windows 95 includes network backup agents from Arcada and Cheyenne. For information, see [Remote Administration](#).

System administration agents.

The Windows 95 compact disc includes agents that run as services for use with system management products from various vendors, including Microsoft Systems Management Server, HP® Openview, Intel® LANDesk™, IBM® LAN NetView®, Sun® NetManager, and Novell NMS. For information, see [Remote Administration](#).

Windows 95 Registry.

In Windows 95, the operating system collects information about the hardware, system configuration settings, and applications and stores it in the Registry. The Windows 95 Registry is a structured database that consolidates configuration and status information for hardware and software components. As a result, this information is available to system management applications ensuring

flexible system management capabilities.

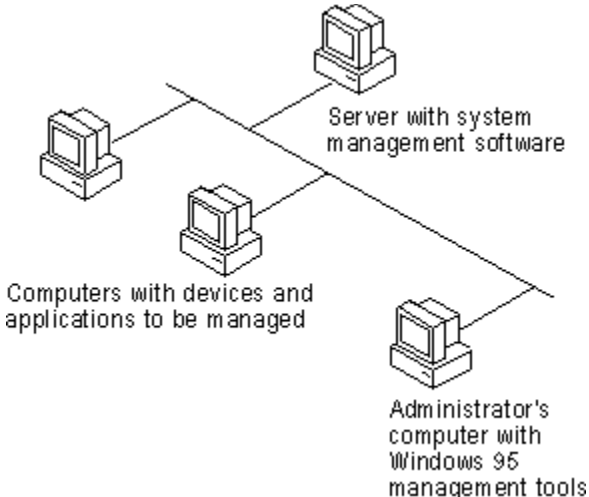

Sources for Windows 95 System Management Tools

The tools and agents that network administrators can use for system management are available from various installation sources. System management software can be installed during Setup or from Control Panel after Windows 95 is installed.

When you install Windows 95 from the installation floppy disks, System Policy Editor is installed automatically with the operational system files. This tool can be used to modify INI files, CONFIG.SYS, and AUTOEXEC.BAT. When you install Windows 95 from the compact disc, Setup installs Registry Editor, the utility used to modify the Registry. The following tools can be installed optionally from the Windows 95 installation disks (either floppy disks or compact disc):

- Disk Defragmenter, DriveSpace, ScanDisk, and Microsoft Backup, as described in [Disks and File Systems](#).
- Net Watcher, as described in [Remote Administration](#).

Some agents and tools are provided only on the Windows 95 compact disc (in the directories shown in the illustration), and not the Windows 95 floppy disks. This software can be installed directly from the compact disc, or the administrator can copy the software to the shared network directory that contains the Windows 95 source files. This software can be installed from custom setup scripts during Windows 95 installation, or by using Control Panel after Windows 95 is installed.

The following administrative tools can be installed from the Windows 95 compact disc by using the Network option in Control Panel:

- Arcada® Backup Exec agent
- Cheyenne® ARCserve agent

The following tools are available only in the ADMIN\APPTOOLS directory on the Windows 95 compact disc. You can run these tools directly from the compact disc or install them locally by using the Add/Remove Programs option in Control Panel:

- Password List Editor (in the PWLEDIT subdirectory), as described in [Security](#).
- System Policy Editor (in the POLEDIT subdirectory), as described in [User Profiles and System Policies](#).

The following agents and services are available only in the ADMIN\NETTOOLS directory on the Windows 95 compact disc. You can install them on a local computer by using the Network option in Control Panel.

- For remote administration:
 - Microsoft Remote Registry service (in the REMOTREG subdirectory)
 - Microsoft SNMP agent (in the SNMP subdirectory)
 - Microsoft Network Monitor agent (in the NETMON subdirectory)

For information about including options from the ADMIN directory on the Windows 95 compact disc — such as the Microsoft Network Monitor agent, SNMP, or SLIP — when installing Windows 95 from a network source, see [Custom, Automated, and Push Installations](#).

Introduction

This chapter presents an overview of the security features provided with Windows 95 and describes how to use them in a networking environment.

- [Windows 95 Security: The Basics](#)
- [Windows 95 Security: The Issues](#)
- [Windows 95 Network Security Overview](#)
- [Setting Up Security for Shared Resources](#)
- [Using Share-Level Security](#)
- [Using User-Level Security](#)
 - [Specifying Directory Access Rights in User-Level Security](#)
 - [Managing User Lists](#)
 - [Security for Windows 95 in NetWare Bindery Environments](#)
- [Using the Windows 95 Password Cache](#)
- [Using Password List Editor](#)
- [Using the Windows 95 Logon Password](#)
- [Using Windows 95 with NetWare Passwords](#)
- [Using System Policies to Enforce Password Security](#)
- [Guidelines for Setting Password Policy](#)

Windows 95 Security: The Basics

You can use Windows 95 security to prevent unauthorized access to the network and to shared resources on computers in a network. The following security features are built into Windows 95.

Unified logon prompt.

With Windows 95, users can log on to all networks and Windows 95 at the same time. If a user's password for Windows 95 or for another network is the same as the password for the primary logon client, Windows 95 automatically logs the user on to Windows 95 and all networks using that password. For more information, see [Using the Windows 95 Logon Password](#).

Windows 95 logon security.

With system policies, you can prevent users from logging on to Windows 95 if their Windows NT or Novell® NetWare® network logon is not validated. To require validation by a Windows NT domain controller or NetWare server before allowing access to Windows 95, you must use system policies to enable Require Validation By Network For Windows Access. For more information, see [User Profiles and System Policies](#).

User-level or share-level security for peer resource sharing.

When a computer is running Windows 95 with File and Printer Sharing services, other users can connect to shared printers, volumes, directories, and CD-ROM drives on that computer. To protect these shared resources, Windows 95 provides user-level and share-level security. With user-level security, a user's request to access a shared resource is passed through to a security provider, a Windows NT or NetWare server, which grants or denies the request. With share-level security, users assign passwords to their shared resources, and any user who can provide the correct password can access the shared resource.

Note You can use user-level security without installing File and Printer Sharing services, such as when using the Remote Registry service.

Password caching.

When a user first types and saves a password when connecting to a password-protected resource, Windows 95 caches the password in the password list file. Logging on with a Windows 95 password unlocks the password list file and associates those passwords with the Windows 95 password. To the user, it seems as if the passwords for Windows 95 and for password-protected resources are the same. If password caching is disabled, users must type the password each time they connect to a password-protected resource.

Password List Editor.

This tool allows you to view and delete the contents of users' password list files.

Password controls in system policies.

You can use system policies to enforce a password policy with greater restrictions, including the following:

- Disable password caching
- Require alphanumeric Windows 95 logon password
- Require minimum Windows 95 logon password length

Other system policies.

You can define policies to prevent users from enabling peer resource sharing services and to enforce other security components, such as preventing users from configuring system components. For more information, see [User Profiles and System Policies](#). See also [Using System Policies to Enforce Password Security](#).

Windows 95 Security: The Issues

Before you integrate Windows 95 security into your network security model, you should consider the following issues:

- What kind of logon security do you need? Do you want to require that users log on to Windows 95 and the network with the same password? Do you want to require alphanumeric or minimum-length passwords for the Windows 95 logon password? Do you want to require that users be validated by the network security provider before being able to log on to Windows 95?

For both Windows NT and NetWare networks, you can use system policies to require validation by a Windows NT or NetWare server before allowing access to Windows 95 and to specify other Windows 95 password restrictions.

- What kind of resource protection do you need on Microsoft networks? If you allow users to enable peer resource sharing, then you must decide whether users can protect those resources with share-level or user-level security. User-level security provides greater security because the network security provider must authenticate the user name and password before access to the resource is granted. (Share-level security is not available for File and Printer Sharing for NetWare Networks.)
- What kinds of access rights will users have to resources protected by user-level security? You can specify the types of rights users or groups of users have to resources by setting Access Control properties in the Network option in Control Panel. For example, you can restrict other users to read-only access to files or give them read and write access to files.
- How do you want to enable user-level security? You can enable security in a setup script, in the Network option in Control Panel, or in system policies. If you enable user-level security in either a setup script or in the Control Panel, then Remote Administration is enabled by default for domain administrators on a Windows NT network and for supervisors on a NetWare network.
- Do you want to disable password caching for password-protected resources? You can use system policies to disable password caching and require users to type a password each time they access a password-protected resource.
- Do you want users to be able to configure system components, their desktops, applications, or network connections in Control Panel? You can use system policies to restrict users' ability to configure components.
- Do you need to control access to a computer's hard disk drive? Because Windows 95 uses network-based security instead of workstation security, an individual computer running Windows 95 is vulnerable to someone accessing data stored on the hard disk by starting the computer using Safe Mode or a floppy disk. If specific data requires greater levels of security, you should store critical files on a secure server. If computers require greater levels of security, Windows NT Workstation is recommended because it provides a means to protect resources on a hard disk based on a user's identity.
- Do you need to prevent users from modifying computer settings or from running certain applications? To implement this type of security, you should use system policies as described in [User Profiles and System Policies](#).

Windows 95 Network Security Overview

Windows 95 provides shared-level and user-level security for protecting shared resources on computers running Windows 95 with File and Printer Sharing services.

- Share-level security protects shared network resources on the computer running Windows 95 with individually assigned passwords. For example, you can assign a password to a directory or a locally attached printer. If other users want to access it, they need to type in the appropriate password. If you do not assign a password to a shared resource, every user with access to the network can access that resource. (This option is not supported with File and Printer Sharing for NetWare Networks.)
- Pass-through user-level security protects shared network resources by requiring that a security provider authenticate a user's request to access resources. The security provider, such as a Windows NT domain control or NetWare server, grants access to the shared resource by verifying that the user name and password are the same as those on the user account list stored on the network security provider. Because the security provider maintains a network-wide list of user accounts and passwords, each computer running Windows 95 does not have to store a list of accounts.

Note If you are running File and Printer Sharing for Microsoft Networks, the security provider must be the name of a Windows NT domain or Windows NT workstation. If you are running Microsoft File and Printer Sharing for NetWare Networks, the security provider must be either a NetWare server or a NetWare 4.x server running bindery emulation.

The following illustration shows how user-level security works on a computer running File and Printer Sharing service and Client for Microsoft Networks. The numbers are explained following the illustration.

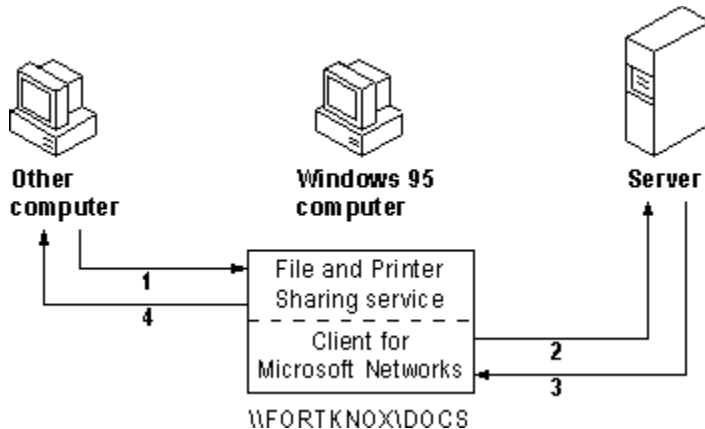

1. A user tries to access a shared resource protected by pass-through user-level security.
2. A request is passed to the security provider to verify the user's identity.
3. The security provider sends a verification to the computer running Windows 95 if the user name and password combination is valid.
4. Windows 95 grants access to the shared resource, and gives permission to use the resource according to rights assigned to the user in Sharing properties for that Windows 95 resource. The user's rights are stored on the computer running Windows 95.

Planning and implementing security in a Windows 95 networking environment requires the following basic kinds of steps:

- Defining user accounts on a network server or domain controller for user-level security. For more information, see the documentation for the software on the network security provider.
- Installing File and Printer Sharing services and enabling user-level or share-level security. For more information, see [Logon, Browsing, and Resource Sharing](#).
- Defining access rights for resources protected by user-level security.
- Making the Windows 95 logon password and network logon password the same, disabling password

caching if you do not want this feature. For more information, see [Using the Windows 95 Password Cache](#) and [Using the Windows 95 Logon Password](#).

- Defining system policies to restrict users' ability to configure the system or shared resources, and to enforce password policies. For information, see [User Profiles and System Policies](#).

Setting Up Security for Shared Resources

Before a user can share a resource on a computer running Windows 95, the computer must be configured for share-level or user-level security, and File and Printer Sharing services must be installed by using the Network option in Control Panel. Configuring share-level or user-level security is described briefly in the following sections, and in [Logon, Browsing, and Resource Sharing](#).

Note Share-level security is not available on computers running Microsoft File and Printer Sharing for NetWare.



To set up share-level security for a single computer

1. Install File and Printer Sharing for Microsoft Networks, as described in [Logon, Browsing, and Resource Sharing](#).
2. In the Network option in Control Panel, click the Access Control tab, and then click Share-Level Access Control.



To set up user-level security on a computer on a NetWare network

1. Install File and Printer Sharing services for NetWare Networks, as described in [Logon, Browsing, and Resource Sharing](#).
2. In the Network option in Control Panel, click the Access Control tab, and then click User-level Access Control.
3. In the User-level Access Control box, type the name of the NetWare server, and then click OK.



To set up user-level security on a computer on a Microsoft network

1. In the Network option in Control Panel, click the Access Control tab, and then click User-level Access Control.

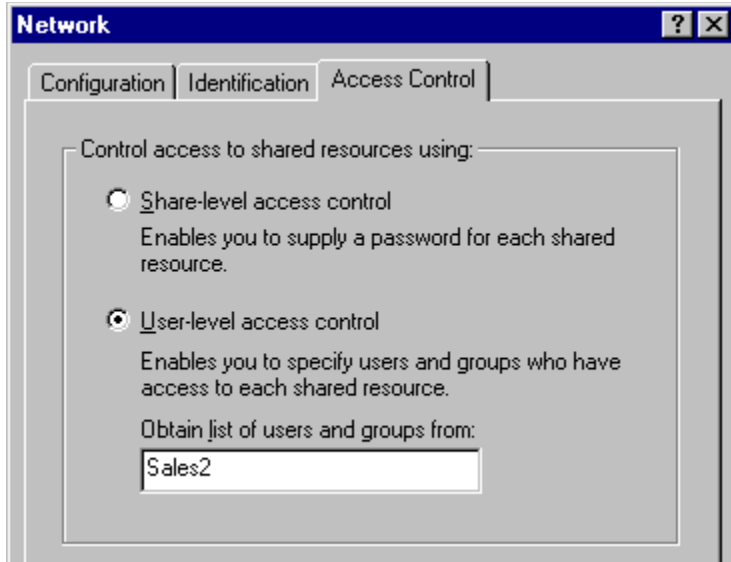

2. Type the name of the Windows NT domain or Windows NT workstation where the user accounts reside, and then click OK.

For information about specifying values for security in custom setup scripts, see [MSBATCH.INF Parameters](#). For information about using System Policy Editor to set user-level security and other security options, see [User Profiles and System Policies](#).

Using Share-Level Security

You can restrict access to a shared directory or printer by either defining it as read-only or assigning a password to it.



To share a directory or printer with share-level security

1. In Windows Explorer or My Computer, right-click the icon for the directory or printer you want to share and, in the context menu, click Sharing.
2. Click the Sharing tab. Then click Share As, and type the resource's share name.

The shared resource name will be the computer name plus the share name. For example, in the following illustration, if the computer name is mycomputer, then this shared resource in \\mycomputer\adamt.

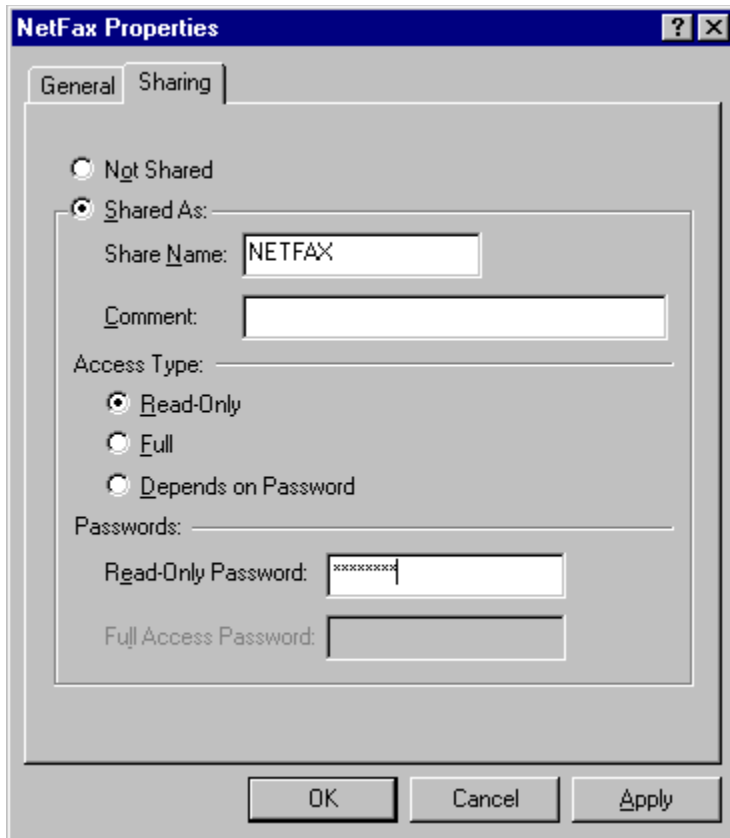

3. Specify whether you want users to have read-only or full access to this resource.
4. Optionally, type the password (or passwords) for read-only or full access, and click OK.

Tip You can share a directory but hide it from the Network Neighborhood browsing list by adding a dollar-sign character (\$) to the end of its share name (for example, PRIVATE\$).

Using User-Level Security

For each network resource or service governed by user-level security, there is a list of users and groups that can access that resource.



To share a directory or printer with user-level security

1. In Windows Explorer or My Computer, right-click a resource and, in the context menu, click Sharing.
2. In the resource's properties, click Add.
3. In the Add Users dialog box, click a user or group, and then assign access rights as described in the following section.

For each user, there is a set of rights assigned for a resource. The kinds of rights that you assign depend on the kind of resource you are securing:

- For shared directories, you can allow a user to have read-only access, full access, or custom access. Within custom access, you can grant the user any or all of the following rights: read, write, create, list, delete, change file attributes, and change access rights.
- For shared printers, a user either has the right to access the printer or not.
- For remote administration, a user either has the right to be an administrator or not as defined in the Passwords option in Control Panel.

Permissions are enforced for a resource as follows:

- If the user has explicit rights to the resource, then those rights are enforced.
- If the user does not have explicit rights to the resource, then the permissions are determined by taking all of the rights of each group to which the user belongs.
- If none of the groups to which the user belongs has any rights to that resource, then the user is not granted access to the resource.

When you do not explicitly assign access rights to a file or directory, Windows 95 uses implied rights. Implied rights are those assigned to a file or directory's nearest parent directory. If none of the parent directories (up to and including the root directory of the drive) have explicit rights, no access is allowed.

Note Implied rights are displayed automatically in the properties dialog boxes of the shared file or directory.

Specifying Directory Access Rights in User-Level Security

Access rights specify what a user can do in a directory protected by user-level security. The access rights you define for a directory apply to all of its subdirectories. You cannot, however, assign permissions to individual files in Windows 95. (Both Windows NT and NetWare allow you to assign permissions to files.)

For each directory, you can assign read-only, full, or custom access. (Read-only and full access are equivalent to the same values used by Windows for Workgroups with share-level security.) Custom access allows you to further specify exactly what each user or group can do in the directory, as specified in the following list.

File operation	Required permissions
Read from a closed file	Read files
See a filename	List files
Search a directory for files	List files
Write to a closed file	Write, create, delete, change file attributes
Run an executable file	Read, list files
Create and write to a file	Create files
Copy files from a directory	Read, list files
Copy files to a directory	Write, create, list files
Make a new directory	Create files
Delete a file	Delete files
Remove a directory	Delete files
Change directory or file attributes	Change file attributes
Rename a file or directory	Change file attributes
Change access rights	Change access control



To define custom access

1. Open the Add Users dialog box in a shared resource's properties as described in the preceding procedure.
2. In the Add Users dialog box, click a user or group, click Custom, and then click OK.
3. In the Add Users dialog box, click a user or group from the Name list, and then click Custom.
4. In the Change Access Rights dialog box, click the type of rights the user or group of users can have in the directory, and then click OK.
5. To remove a user or group of users, click the user or group of users, and then click Remove.
6. To edit the access rights for a user or group of users, click the user or group of users, and then click Edit.

Security

Using User-Level Security

Managing User Lists

Windows 95 user-level security depends on a list of accounts and groups located on a security provider. You cannot add or remove users and groups from the security provider list by using Windows 95 tools. However, you can do this by running User Manager for a Windows NT domain, SYSCON for NetWare 3.x, and NETADMIN for NetWare 4.x. in a NetWare bindery environment. You can use these tools on a computer running Windows 95. These tools are provided by the respective vendors and not by Windows 95.

Under Windows 95, you specify what rights users have to specific resources on the local computer as described in the preceding section. For more information about changing a user's access rights, see [Specifying Directory Access Rights in User-Level Security](#).

Note Although Windows NT networks allow multiple domains, a computer running Windows 95 can specify only one domain for user-level security. To use a trust relationship to access multiple domains, you should consult the *Windows NT Server 3.5 Concepts and Planning Guide* that is part of the Windows NT Server documentation set.

Security

Using User-Level Security

Security for Windows 95 in NetWare Bindery Environments

NetWare 3.x servers store all the information about users, groups, passwords, and rights in a database stored on the server called the bindery. NetWare 4.x servers can appear to have a bindery through bindery emulation, a feature which is enabled by default. There is a separate bindery for each NetWare server. Windows 95 can use the bindery of only one NetWare server as the security provider.

It is common for a company to have one or more NetWare servers per department, where users log on to the server for their department. This scenario can pose a problem when the list of accounts differs from one NetWare server to another.

For example, Sue and Bob log on to the Sales server and Fred logs on to the R&D server. Because Sue is running Windows 95 and can specify only one server for pass-through validation, she specifies Sales (the server she uses for logon). She can now grant access to shared resources on her computer to Bob but cannot grant access to Fred.

The only way to solve this problem is to include all user accounts for all servers on one NetWare server. This server should be specified as the security provider for every computer running Windows 95 with File and Printer Sharing for NetWare Networks.

Note User-level security in Windows 95 does not support the use of NetWare domains and the NetWare Name Service (NNS), an Add-On service for NetWare 4.x servers to obtain user lists. Windows 95 does support NetWare 4.x with bindery emulation to obtain user lists.

Using the Windows 95 Password Cache

Keeping track of multiple passwords can be a problem for users. Often, they either forget the passwords or write them down and post lists of passwords near their computers. When this happens, the security policy is no longer doing the job it was meant to do — to allow access to those who should have it and to deny access to those who shouldn't.

Windows 95 solves this problem by storing passwords for resources in a password list file (.PWL). This file stores passwords for the following network resources:

- Resources on a computer running Windows 95 protected by share-level security
- Applications that are password-protected: these applications must be specifically written to the Master Password API
- Windows NT computers that don't participate in a domain, or the Windows NT logon password if it isn't the Primary Network Logon
- NetWare servers

The password list file is stored in the Windows directory on the local computer. Each resource typically has its own password. The password file is encrypted by using an algorithm. An unencrypted password is never sent across the network.

Caution If you delete .PWL files, you will lose all previously stored passwords. You will need to retype each password.

Password caching is enabled by default when you install Windows 95. When you access a password-protected resource for the first time, make sure the Save This Password In Your Password List option is checked to save the password to the password list file.

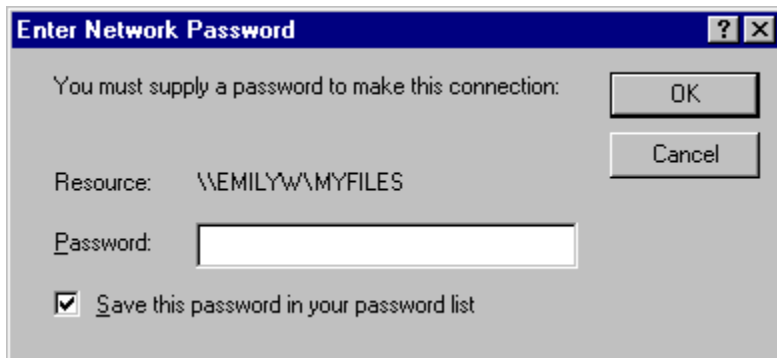

Note If, during logon, you click the Cancel button to bypass the logon screen, the cache will not be opened and you will be prompted for a password each time you attempt to use a protected resource.

You can disable password caching by using System Policy Editor.



To disable password caching by using system policies

1. In System Policy Editor, double-click the Local Computer icon.
2. In the Local Computer Properties, click Network, and then click Passwords.
3. Click the policy named Disable Password Caching.

For more information, see [User Profiles and System Policies](#).

Note If you have any share-level security servers and you disable password caching and are running Client for Microsoft Networks, you should not use the Quick Logon feature in the Network option in Control Panel.

Using Password List Editor

If password caching is enabled, Windows 95 caches passwords in the password list file when you connect to a password-protected network resource. Password List Editor (PWLEDIT) allows you to view the resources listed in a user's password list file (.PWL). It does not allow you to view the actual passwords, but it allows you to remove specific password entries if problems are encountered using a cached password.

Password List Editor works only if the password list file is unlocked, that is, if the user is logged on. It can be used to view only the contents of the logged-on user's password list file, so you should run it on the user's computer.

Password List Editor can be found in the ADMIN\APPTOOLS\PWLEDIT directory on the Windows 95 compact disc.



To install Password List Editor

1. In the Add/Remove Programs option in Control Panel, click the Windows Setup tab, and then click Have Disk button.
2. In the Install From Disk dialog box, click Browse. Type the path name to ADMIN\APPTOOLS\PWLEDIT\PWLEDIT.INF, and then click OK.
3. In the Have Disk dialog box, click Password List Editor, and then click Install.



To run Password List Editor

- From the Start menu, click Run, and type **pwledit**

Using the Windows 95 Logon Password

With Windows 95, users can log on to all networks and Windows 95 at the same time. The first time a user starts Windows 95, logon dialog boxes appear for Windows 95 and for each network client on that computer. This is useful for you as a network administrator because you can use existing user accounts on a network security provider to validate access to the network for users running Windows 95. For more information, see [Logon, Browsing, and Resource Sharing](#).

If a user's password for Windows 95 or for another network is the same as the password for the primary logon client, Windows 95 logs the user on to Windows 95 and the network automatically using that password. When a user logs on to other networks with different passwords and chooses to save them, the passwords are stored in the password list file. The Windows 95 password unlocks this password list file. Thereafter, Windows 95 uses the passwords stored in the password list file to log a user on to other networks so no additional passwords need to be typed.

The Passwords option in Control Panel provides a way to synchronize logon passwords for different networks. This allows users to use the password for whatever logon dialog box appears first (the primary network logon client or Windows 95 logon) for logging on to all the other network clients.

You can also use the Passwords option to change individual passwords to other network resources to be different than the Windows 95 logon password.



To change a password for a network resource to be the same as the Windows 95 logon password

1. In the Passwords icon option in Control Panel, click Change Windows Password.
2. In the Change Windows Password dialog box, check the other passwords you would like to change to use the same password as the Windows 95 password, and then click OK.

To appear in this list, the related software must include a function that allows its password to be changed.



3. In the second Change Windows Password dialog box, type the current (old) Windows 95 password, type a new password, and then, in the Confirm New Password box, type the new password again.

Note The Windows Screen Saver passwords option will show up here only if the Windows screen saver has been turned on and the password-protected option has been selected.

You can maintain separate passwords for a network resource and require users to type a password each time they access it.



To change a password for a network resource

1. In the Passwords option in Control Panel, click Change Other Passwords.

2. In the Select Password dialog box, click the password you want to change, and then click Change.
3. In the Change Password dialog box, type the current (old) password, type a new password, and then in the Confirm New Password box, type the new password again. Click OK.

You now must type a separate password to access the resource.

Using Windows 95 with NetWare Passwords

To log on to a NetWare network, you must type the name of the preferred server on which the related user account is stored. After the user name and password are validated by the network server, you can use resources shared on that server. If you are not validated, you will be prompted to enter a password whenever connecting to a NetWare server during this work session.

The first time you attempt to connect to a NetWare server other than the preferred server, the NetWare server searches the Windows 95 password list file for a user name and password to that server. If the user name and password pair are not valid, NetWare displays a dialog box and asks you to type a user name and password. If there is no NetWare user name and password in the password list file, NetWare tries using the Windows 95 logon password. You can disable this automatic attempt to log on to NetWare resources.



To avoid use of automatic NetWare logon

- Use system policies to enable the policy named Disable Automatic NetWare Login. For information, see [User Profiles and System Policies](#).



To change your password on a NetWare server

1. At the command prompt, use the **net use** command to connect to the NetWare server's SYS volume. For example, for a server name NWSVR2, you would type:

```
net use * \\nwsvr2\sys
```

2. At the command prompt, change to the drive for the NetWare server, and then make the PUBLIC directory the current directory. For example, if the drive is mapped to drive N, type:

```
n:
```

Then type:

```
mdcd \public
```

Note If you want to change your password on more than one server, connect to all affected servers before running the **setpass** command. Setpass is a utility provided by Novell and is not part of Windows 95.

3. At the command prompt, type **setpass**

If the server on which you want to change your password is different from the one on the current drive, type **setpass** and the server name.

For example, to change your password on the server named NWSERVE1, type:

```
setpass nwserv1
```

4. When you are prompted, type your old password, then type and confirm the new password.
5. If you are connected to other NetWare servers that also use your old password, these servers are listed, and you are asked if you want to change your password on these servers also.

Using System Policies to Enforce Password Security

You can use system policies to increase security by forcing users to follow specific password guidelines. Using system policies, you can enforce the following password policies:

- **Require Validation By Network For Windows Access**, to specify that each logon be validated by a server before access to Windows is allowed. This applies to Windows NT and NetWare networks.
- **Disable Automatic NetWare Login**, to specify that when Windows 95 attempts to connect to a NetWare server, it does not automatically use the user's logon name and password or the password list file.
- **Minimum Windows Logon Password Length**, to control the minimum number of characters accepted for a Windows 95 logon password.
- **Require Alphanumeric Windows Logon Password**, to force a Windows 95 logon password to be a combination of numbers and letters.
- **Hide Share Passwords With Asterisks**, to cause asterisks to replace characters that users type when accessing a shared resource. This setting applies only to share-level security and is enabled by default.
- **Disable Passwords Control Panel**, to prevent access to the Passwords option in Control Panel.
- **Hide Change Passwords Page**, to hide this properties dialog box in the Passwords option in Control Panel.
- **Disable Password Caching**, to prevent saving of passwords for share-level resources, applications, and for NetWare passwords.
- **Disable Caching Of Domain Password**, to prevent the caching of the network password.

For information about restricting settings with system policies, see [User Profiles and System Policies](#).

Guidelines for Setting Password Policy

A good password policy helps users protect their passwords from other individuals. This helps to reduce the probability of someone logging on with another user's password and gaining unauthorized access to data.

The following guidelines should help you create a basic security policy:

- Tell users not to write down their passwords.
- Tell users not to use obvious passwords, such as their name, their spouse's name, the names of their children, and so on.
- Do not distribute user accounts and passwords in the same communication. For example, if you are sending a new user's account name and password in writing, send the user name and the password at different times.

You can use the following Windows NT and NetWare security features to enhance Windows 95 security:

- Enforce a reasonable minimum password length, which increases the number of permutations needed to randomly or programmatically guess someone's password. Additionally, you can enforce an alphanumeric password combination to achieve the same security.
- Enforce maximum and minimum password age. A maximum password age forces the user to change the password, preventing someone else from discovering it as a result of the password being in use for a long time. A minimum password age prevents a user from immediately reverting back to a previous password after a change.
- Enforce password uniqueness and maintain password history. This prevents users from toggling between their favorite passwords. You can specify the number of unique passwords that a user must have before that user can use a password that has previously been used.

Introduction

This chapter describes how user profiles can help users maintain their own preferences, network settings, and application settings when logging on to a workstation. This chapter also describes how you can use system policies to control what users can and cannot do on the desktop and on the network. These features can help decrease the cost of managing numerous computers by allowing you to manage configurations remotely.

- [User Profiles and System Policies: The Basics](#)
- [User Profiles and System Policies: The Issues](#)
- [User Profiles Overview](#)
- [Enabling User Profiles](#)
 - [Setting Up User Profiles on a Windows NT Network](#)
 - [Setting Up User Profiles on a NetWare Network](#)
 - [Disabling Standard Roving Profiles](#)
 - [Maintaining Roving User Profiles on Other Networks](#)
 - [Defining Mandatory User Profiles](#)
- [System Policies Overview](#)
 - [Overview of System Policies for Users](#)
 - [Overview of System Policies for Computers](#)
- [System Policy Editor](#)
 - [Installing System Policy Editor](#)
 - [Using System Policy Editor](#)
- [Preparing to Use System Policies on the Network](#)
 - [Setting Up for Automatic Downloading of System Policies](#)
 - [Setting Up for Manual Downloading of System Policies](#)
- [Creating System Policies](#)
 - [Creating Policies for Individual Users or Computers](#)
 - [Creating Policies for Groups](#)
 - [Managing Custom Folders for Use with System Policies](#)
- [System Policy Examples](#)
 - [Recommended Standard Desktop Configuration](#)
 - [Recommended Maximum Control Desktop Configuration](#)
- [System Policy Settings Summary](#)
 - [Restricting Access to User-Specific Settings](#)
 - [Restricting Access to Computer-Specific Settings](#)
- [System Policy Templates](#)
- [Troubleshooting with System Policy Editor](#)

User Profiles and System Policies: The Basics

A user profile consists of user-specific information contained in the file USER.DAT, which is one of the two files in the Windows 95 Registry. Optionally, a user profile can also contain special Windows 95 directories. The benefits of using user profiles are summarized in this section.

Multiple users on a computer can retain their personal settings.

"Roving" users can log on to the network from any computer and work with the same desktop settings as long as the computer is running a Windows 95 32-bit, protected-mode network client.

Windows 95 automatically maintains each user's profile.

Whether profiles are stored locally or on the network, you need to enable user profiles only for the computers where they will be used.

Mandatory profiles can be used to enforce consistent desktops.

This is useful for novice users who cannot manage their own desktop settings. Mandatory profiles increase user productivity and ease the burden of training and support for system managers.

System policies allow you to override local Registry values for user or computer settings. Policies are defined in a policy (.POL) file, usually called CONFIG.POL. When a user logs on, system policy settings overwrite default settings in the Registry. You can also set system policies to contain additional custom settings specific to the network.

Unlike SYSTEM.DAT and USER.DAT (the two files that make up the Registry), CONFIG.POL is not a required component of Windows 95 Setup and, when implemented, is stored on the logon server, not the local computer. The following list summarizes the benefits of system policies.

System policies can be used to enforce system configuration.

You can restrict what users are allowed to do from the desktop and what they are allowed to configure using Control Panel. Also, you can use system policies to centrally configure network settings, such as the network client configuration options and the ability to install or configure File and Printer Sharing services. Finally, policies can be used to customize certain parts of the desktop, such as Network Neighborhood or the Programs folder.

Registry settings can be changed by using System Policy Editor.

You can use System Policy Editor to change many common Registry settings, either for an individual local or remote computer. You can use these settings in a system policy file to change Registry values on multiple computers.

System policies can be applied individually or per group.

You can use group policies to define a set of policies to be applied on the basis of membership in the groups already defined on a NetWare or Windows NT network. Group policies make computer management on the corporate network easier by leveraging the current administrative organization of users.

Windows 95 provides a set of policies that you can use to specify settings for users. You can also add new Registry settings to this set of policies or you can modify policy templates to create new custom policies for any applications that use the Windows 95 Registry.

User Profiles and System Policies: The Issues

You can use system policies or mandatory user profiles to enforce user settings. You should choose to use one method or the other, but not both. The two features differ in the following ways:

- System policies let you mandate user-specific and computer-specific settings. Mandatory user profiles let you mandate only user-specific settings.
- System policies let you selectively determine a subset of user settings to control, and each user controls the remaining settings. Mandatory user profiles always control every user-specific setting.

Before implementing user profiles, you should consider the following issues:

- Do you want to use system policies for user settings? If so, you must enable user profiles on the computer.
- What do you want to include in user profiles? For example, you might choose to include the desktop, Start menu, or Network Neighborhood in the user profile.
- Do you want user profiles to work across the network so that they are available to roving users? If so, the computers must be running a 32-bit, protected-mode network client. Also, you must make sure that each user has a home directory on the network.
- Should mandatory user profiles be used? If so, you must copy the necessary files to each user's home directory.

If you want to make user profiles available on the network (rather than on individual computers), you must perform the following preliminary steps:

- Install and run a 32-bit, protected mode networking client (such as Client for NetWare Networks or Client for Microsoft Networks) on the computers.
- Make sure that the server supports long filenames for full user profile functionality. If the server doesn't support long filenames, only USER.DAT will follow a user around the network. Users will not be able to download other folders (such as those that support the Start menu and Network Neighborhood configuration).
- For Microsoft networks, make sure that a network home directory exists for each user because this is where user profiles are placed. (On Novell® NetWare® networks, profiles are placed in the MAIL/user_ID directory, which always exists.)
- For each computer, use the same names for the directory and the hard disk drive in which Windows 95 is installed. If Windows 95 is installed in C:\WINDOWS on one computer and in C:\WIN95 on another computer, some components of the user profile will not be transferred between the two computers. This is also true if Windows 95 is installed on different hard disks on different computers (for example, C:\WINDOWS on one computer, and D:\WINDOWS on another).

Before implementing system policies, you should consider the following issues:

- What types of restrictions and settings would you like to define and manage centrally? For example, do you want to limit access to the MS-DOS prompt and other applications or to Control Panel options, or do you want to implement a standard desktop for all users?
- Do you want to use one set of standard settings for all users and computers, or do you want to customize settings by groups of users? Also, do you want to maintain individual settings for users and computers? Typically, you customize settings by groups, where the majority of users are in groups such as Accounting, Marketing, and so on, and a small group of individuals (such as administrators) have special privileges. If so, you must install special files to support group policies.
- Will you be using user system policies (as opposed to defining only computer policies)? If so, user profiles must be enabled on the computers running Windows 95, which in turn requires that the computers use 32-bit, protected-mode network clients.
- Do system policies in Windows 95 meet your system administration needs, or do you need a more sophisticated system? If you need a high level of administrative control, you might want to consider using a more sophisticated management software tool, such as Microsoft Systems Management Server, rather than System Policy Editor. For information, see [Microsoft Systems Management Server](#).

If you want to use system policies, you must perform the following preliminary steps:

- On the administrator's computer, install System Policy Editor from the ADMIN\APPTOOLS\POLEDIT directory on the Windows 95 compact disc. Decide which users can install and have access to this tool for modifying policies. For most client computers, you probably will not install System Policy Editor.
- On the client computers, enable user profiles to ensure full support for system policies. If user profiles are not enabled, only the computer settings in any system policy will be written to the Registry.
- Install support for group policies on the client computers if your site will use these. For information, see [System Policy Editor](#).

Tip You can enable user profiles and related settings automatically when installing Windows 95 by using custom setup scripts. For information, see [MSBATCH.INF Parameters](#).

User Profiles Overview

In Windows 95, user profiles contain configuration preferences and options for each user. They are particularly useful when users are encouraged to customize their computing environment, yet are forced to share computers with others who are also customizing their environments. User profiles are also beneficial to network administrators or help desk personnel who typically roam around, accessing the network from a variety of locations. Such users can work anywhere as if they were sitting at their own desks.

User profile settings include everything in the Hkey_Current_User section of the Windows 95 Registry, such as the following:

- Control Panel settings and preferences for the Windows 95 user interface, including settings for desktop layout, background, font selection, colors, shortcuts on the desktop, the Start menu, and so on.
- Settings for persistent network connections, plus information for recently used resources, including documents, Find Computer results, installation locations for setup, and printer ports.
- Application settings (for applications that can write directly to the Windows 95 Registry), including settings for the accessories and applications installed with Windows 95, menu and toolbar configurations, fonts, and so on.

Each user profile includes several parts: a USER.DAT file, a backup USER.DA0 file, a Desktop folder, a Recent folder, and a Start Menu folder, plus the Programs folder under Start Menu. These folders are in the directories for each user, which are in the Windows Profiles directory, as shown in the following illustration.

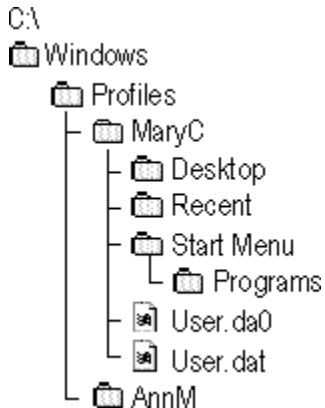

When user profiles are enabled, users get their own configuration when they log on to a computer. Users can define their own preferences by customizing their desktops. Alternatively, you can define a standard user profile for use across the network or for a set of specific users.

Each user's preferences are saved to a user profile that Windows 95 uses to configure the desktop each time that user logs on. When a second user logs on to the same computer with a different user name, Windows 95 creates a separate user profile for that user. A roving user's profile is stored on a network server and downloaded to any computer on the network to which the user logs on. This occurs automatically on a NetWare and a Windows NT network. However, although Windows 95 offers the ability for roving users to move from one computer running Windows 95 to another, it does not offer the ability to move between a computer running Windows NT and one running Windows 95.

Important Although a user profile is based on the USER.DAT file that makes up part of the Windows 95 Registry, this file cannot be edited with a text editor. To define and manage user profiles, you must use the Windows 95 tools such as Control Panel for setting configuration options, and perform the procedures described in the following sections.

In the PROFILES subdirectory of the Windows directory, a folder is created for each user who has a profile on that computer. Each of these folders contains the following:

- A USER.DAT file that contains the user portion of the Registry
- A USER.DA0 file that contains the backup for USER.DAT
- A Desktop folder that contains the contents of Desktop
- A Recent folder that contains the contents of the Documents option on the Start menu
- A Start Menu folder that contains the contents of the Start menu, and includes the Programs folder

How Do User Profiles Work?

Each time the user logs on to a computer, Windows 95 searches the Registry under the following key to determine whether the user has a local profile:

```
Hkey_Local_Machine\Software\Microsoft\Windows\Current
Version
  \Profile List
```

Windows 95 also checks for the user profile in the user's home directory on the server. If the user profile on the server is the most current, Windows 95 copies it to the local computer for use during the current session, and then it loads the settings in this local copy into the Registry. If no local user profile exists, Windows 95 copies the server version to the local computer. If no profile is found, Windows 95 creates a new user profile on the local computer using default settings. If the user doesn't log on, then Windows 95 automatically uses the default user profile.

Both the local and network copies of the user profile are automatically updated with current settings when the user logs off.

If the user is logged on at more than one computer at the same time, any changes made to the profile on the computer where the user first logs off will be overwritten when the user logs off the other computer. In other words, the last logoff is saved, and no merging of changes occurs.

User Profiles and System Policies

Enabling User Profiles

You can enable user profiles after Windows 95 is installed, either locally on a single computer or for multiple computers. You can avoid having to go to each computer to enable user profiles by creating a system policy that can be downloaded automatically when the initial Windows 95 installation is complete. For information about enabling user profiles centrally on multiple computers, see [System Policies Overview](#).



To enable user profiles on a local computer after setup

1. In the Passwords option in Control Panel, click the User Profiles tab.
2. Click to select the option named Users Can Customize Their Preferences And Desktop Settings.

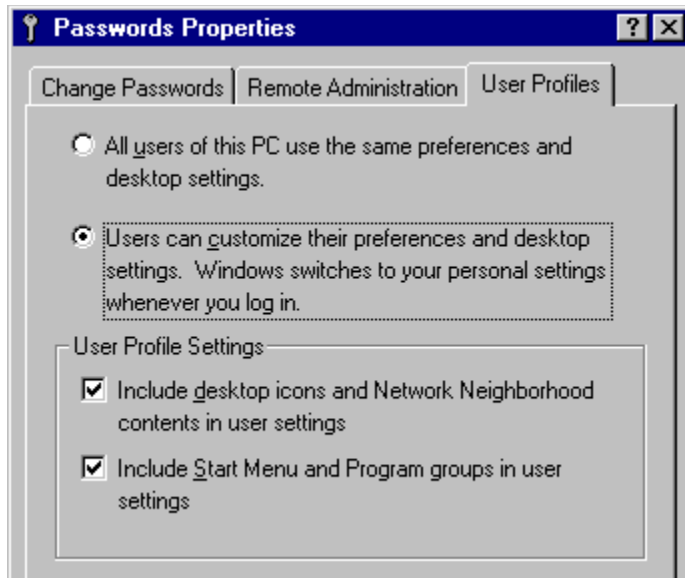

3. Click the options you want under User Profile Settings. These options describe what should be included as part of the user profile.
4. Shut down and restart the computer.

Tip If you include desktop icons in your user profile, only the shortcuts (icons that represent links) will be available when you log on to the network from another computer. Actual files on your desktop are part of your local user profile only.



To disable user profiles on a local computer

- In the Passwords option in Control Panel, click the User Profiles tab. Make sure the option named All Users Of This PC Use The Same Preferences And Desktop Settings is selected.

Note If an application is installed after user profiles are enabled with the option to include the Start menu and Programs in the profile, only the user who was logged on when the application was installed will have an entry for that application on the Programs menu. Other users will have to create shortcuts to the application on their Programs menus.

Setting Up User Profiles on a Windows NT Network

You can use user profiles with Windows 95 on a Windows NT network if the computer is configured to use Client for Microsoft Networks.

Note Windows 95 does not use the PROFILES directory on a Windows NT server; that directory is used only for Windows NT profiles.



To set up user profiles on a Windows NT network

1. For each computer, make sure that user profiles are enabled, as described in [Enabling User Profiles](#).
2. In the Network option in Control Panel, make sure Client for Microsoft Networks is selected as the Primary Network Logon client.
3. On the Windows NT server, make sure each user is properly set up and has an assigned home directory on a Windows NT network server. (You can use the Windows NT User Manager tool to create this directory.)

When the user logs off, Windows 95 automatically places an updated copy of the user profile in the user's assigned home directory on the Windows NT network, in the following path.

`\\logon_server\user's home directory`

For information about User Manager and home directories, see *Microsoft Windows NT Server 3.5 User Guide*.

User Profiles and System Policies

Enabling User Profiles

Setting Up User Profiles on a NetWare Network

You can use user profiles with Windows 95 on a NetWare network if the computer is configured to use Microsoft Client for NetWare Networks.

When a user account is created on a NetWare server, a subdirectory of the MAIL directory is automatically created for that user. Windows 95 uses this directory to store user profiles.



To set up user profiles for a Novell NetWare network

1. For each computer, make sure that user profiles are enabled, as described in [Enabling User Profiles](#).
2. In the Network option in Control Panel, make sure Client for NetWare Networks is selected as the Primary Network Logon client.
3. Make sure each user has an established MAIL directory.

When the user logs off, Windows 95 automatically places an updated copy of the user profile in the user's assigned MAIL directory on the NetWare network, as indicated in the following. (The user's 8-digit ID can be determined by using the NetWare SYSCON utility.)

```
\\preferred_server\sys\mail\user_id
```

User Profiles and System Policies

Enabling User Profiles

Disabling Standard Roving Profiles

You might want to have user profiles enabled on a computer, but not allow the profiles to move between that computer and others. For example, if a user simultaneously uses a main computer running File and Printer Sharing services and other auxiliary computers, the roving profile for the auxiliary computers might include persistent connections to shared directories on the user's main computer. This profile would not work well on the main computer itself, since a computer cannot connect to itself.



To disable roving profiles on a particular computer

1. In Registry Editor, expand the Hkey_Local_Machine\Network key, and select the Logon subkey.
2. On the Edit menu, point to New, and then click DWORD Value.
3. Type **UseHomeDirectory** and press ENTER.

Maintaining Roving User Profiles on Other Networks

Windows 95 has limited support for user profiles if the network does not have support for a 32-bit, protected-mode client or centralized network logon. This includes networks that provide only 16-bit network clients and peer networks such as Windows for Workgroups or Windows 95 without a Windows NT domain.

To enable roving user profiles on such a network, you must first establish a network directory that can be accessed by all users. For security reasons, you should make sure that this directory has read-only permissions so that users cannot modify it. You must create a text file in that directory that lists the home directories for all users who can use roving user profiles. For example, such a file might be named PROFILES.INI on \\BIGSEVER\PROFILES, and have the following contents:

```
[Profiles]
Mary=\\bigserver\homedirs\mary
John=\\bigserver\homedirs\john
Pat=\\bigserver\homedirs\pat
```

After you have created this file, you must configure each computer running Windows 95 to use it. First, disable roving profiles. For more information about disabling roving profiles, see [Enabling User Profiles](#). Then do the following:



To configure a computer for roving user profiles on other networks

1. In Registry Editor, select the Hkey_Local_Machine\Network\Logon subkey.
2. On the Edit menu, point to New, and then click String Value.
3. Type **SharedProfileList** and press ENTER. Then press ENTER again.
4. In the Edit String dialog box, type the UNC path and filename for the home directory list (for example, \\BIGSERVER\PROFILES\PROFILES.INI). Click OK.

Thereafter, when a user logs on at this computer, Windows 95 will look in the specified text file to determine the user's home directory. The user's profile will be loaded from that home directory as it is from other networks. If the user is not listed in the text file, the user profile will be local only.

Defining Mandatory User Profiles

In Windows 95, you can create mandatory user profiles for use on Windows NT or NetWare networks. You can use this feature to create a standard user profile for each computer and make sure it is implemented at every logon. To do this, create a USER.DAT file with the settings you want, save it as USER.MAN, and place it in the network directory for each user you want to use that profile. The network directory is either the user's home directory (on a Windows NT network) or MAIL directory (on a NetWare network).

If USER.MAN is present when the user logs on, Windows 95 uses this mandatory copy to load settings into the Registry rather than any previous local user profile. If the user manually makes changes to the desktop configuration during the work session, these changes are not saved to the master copy in the user's network directory when the user logs off.



To create a mandatory user profile

1. Enable user profiles. For information about enabling user profiles, see [Enabling User Profiles](#).
2. On any computer running Windows 95, customize the desktop as you want it to be for the mandatory user profile.
3. Copy the required files for the user profile to the home directory for Windows NT networks or to the MAIL directory for NetWare networks, as described in [Setting Up User Profiles on a NetWare Network](#).

Note Windows 95 copies these files automatically for normal user profiles, but not for mandatory user profiles.

4. Rename USER.DAT to USER.MAN in the user's home directory.

System Policies Overview

System policies offer you a powerful mechanism for increasing control and manageability of computers across the network. You do not need to use a 32-bit, protected-mode client to use system policies. (If you want to define user settings, however, you must enable user profiles.) With system policies, you can do the following:

- Restrict access to Control Panel options
- Restrict what users can do from the desktop
- Customize parts of the desktop
- Configure network settings

For example, you can preset a user's environment so that the MS-DOS prompt or unapproved applications are not available. You can choose from the set of system policies offered by Windows 95 or create custom system policies.

Note You should make some decisions about the default set of system policies before installing Windows 95. For information, see [Deployment Planning Guide](#).

The system policy entries you set through System Policy Editor are reflected in the policy file (CONFIG.POL), which overwrites default USER.DAT and SYSTEM.DAT settings in the Registry when the user logs on. Policy entries change Registry settings in the following way:

- Desktop settings modify the Hkey_Current_User key in the Registry, which defines the contents of USER.DAT. All policy settings affecting USER.DAT are defined for a specific user or for the default user.
- Logon and network access settings modify the Hkey_Local_Machine key in the Registry, which defines the contents of SYSTEM.DAT. All policy settings affecting SYSTEM.DAT are defined for a specific computer or for the default computer.

The following figure shows how these settings are interrelated.

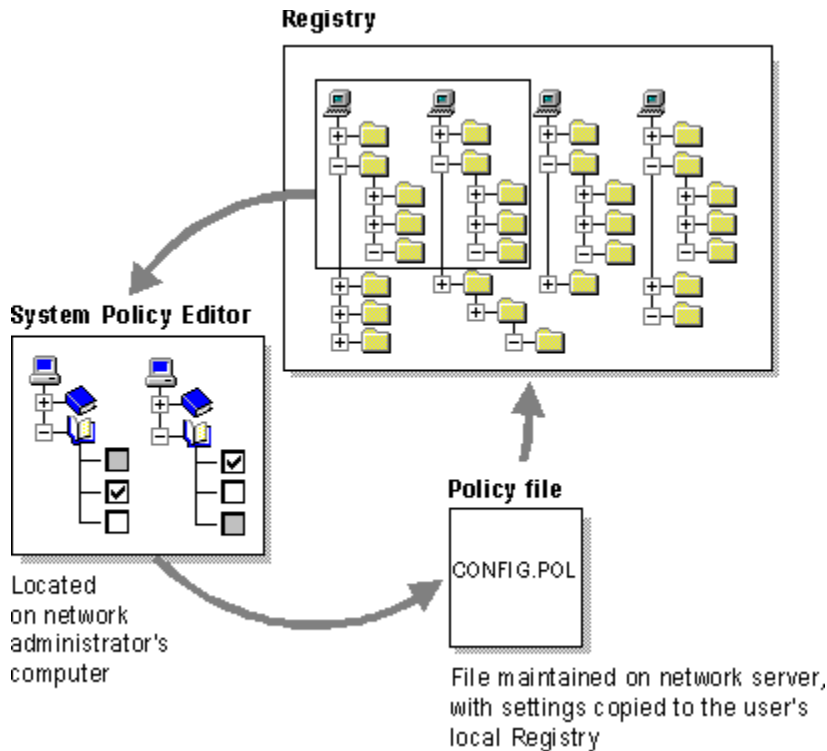

To use System Policy Editor, you must install the following files from ADMIN\APPTOOLS\POLEDIT: ADMIN.ADM, POLEDIT.EXE, and POLEDIT.INF. ADMIN.ADM is placed in the INF subdirectory of the

Windows directory, and it provides the template to use with System Policy Editor for creating a CONFIG.POL file. CONFIG.POL must be placed in a secure network location. Any custom templates that you create will use the .ADM filename extension.

If you want to use group policies, GROUPOPOL.DLL must be placed in the SYSTEM subdirectory of the Windows directory on each client computer. In addition, you must make some changes to the Registry on each computer to use GROUPOPOL.DLL. For more information, see [System Policy Editor](#).

Important System policies are based on the content of the Registry and cannot be edited with a text editor. To define and manage system policies, you must use System Policy Editor and other supporting tools.

You can, however, use a text editor to edit the template files used by System Policy Editor, as described in [System Policy Templates](#).

How Do System Policies Work?

When the user logs on, Windows 95 checks the user's configuration information for the location of the policy file. Windows 95 then downloads the policies and copies the information into the Registry by using the following process:

1. If user profiles are enabled, Windows 95 checks for a user policy file that matches the user name. If it finds one, Windows 95 applies the user-specific policy. If Windows 95 does not find a user policy file, it applies the Default User policy file.

If support for group policies is installed on the computer, then Windows 95 checks whether the user is registered as a member of any groups. If so, group policies are downloaded starting with the lowest priority group and ending with the highest priority group. Group policies are processed for all groups the user belongs to. The group with the highest priority is processed last so that the settings in that group's policy file supersede those in lower priority groups. Group policies are not applied if there is a policy file for a specific user.

Then, all settings are copied into the USER.DAT portion of the Registry.

2. Windows 95 checks for a computer policy file to match the computer name. If one exists, Windows 95 applies the computer-specific policies to the user's desktop environment. If a policy file for that computer name doesn't exist, Windows 95 applies the default computer policies. This data is then copied into the SYSTEM.DAT portion of the Registry.

By default, Windows 95 automatically attempts to download computer and user policies from the NETLOGON directory on a Windows NT server or the PUBLIC directory on a NetWare server. This default location can be overridden in a policy file setting. If no server is present, Windows 95 uses the settings currently on the computer.

User Profiles and System Policies

System Policies Overview

Overview of System Policies for Users

You can manage user settings in system policies only if user profiles are enabled on the target computer. System Policy Editor uses the properties for Default User to define the default policies in the following areas:

Control Panel.

Set policies to prevent the user from accessing Control Panel features, such as network, password, or system settings.

Desktop.

Set policies to use standard wallpaper and color schemes.

Network.

Set policies to restrict peer resource sharing or to specify networking components and settings.

Shell.

Set policies to customize folders on the desktop and to restrict changes to the user interface.

System.

Set policies to restrict the use of Registry editing tools, applications, and MS-DOS-based applications.

You can apply these policies to the default user, to specific named users, or to groups of users. For more information about the settings for each of these categories, see [System Policy Settings Summary](#).

User Profiles and System Policies

System Policies Overview

Overview of System Policies for Computers

You can use System Policy Editor to define settings for a default computer or for specific named computers. The default computer settings are used when a new user logs on to a computer that does not have individual policies assigned.

Computer settings in system policies prevent users from modifying the hardware and environment settings for the operating system, ensuring that Windows 95 starts up in a predictable way. You can set options to restrict access to computer-specific system and network features, as described in [System Policy Settings Summary](#).

System Policy Editor

You can use System Policy Editor to create system policies. More specifically, you can do the following with System Policy Editor:

- Set entries for the default computer and user policy entries. This creates a default policy file for all users and computers, which is downloaded when the user logs on.
- Create entries for individual users, individual computers, or groups of users. By default, these include the policy entries you defined for Default User and default computer.
- Specify whether and in what manner you want policies downloaded from a centralized server or specify whether you want to have policies downloaded from other specific locations for all or some users.

Caution System Policy Editor is a powerful tool; you should restrict its use to network administrators only. To avoid unauthorized use, do not install this tool on users' computers, and restrict access to the source files so that users cannot install it themselves.

Installing System Policy Editor

You can install and use System Policy Editor from the ADMIN directory on the Windows 95 compact disc.



To install System Policy Editor

1. In the Add/Remove Programs option in Control Panel, click the Windows Setup tab, and then click Have Disk.
2. In the Install From Disk dialog box, click Browse and specify the ADMIN\APPTOOLS\POLEDIT directory on the Windows 95 compact disc. Click OK, and then click OK again.
3. In the Have Disk dialog box, make sure System Policy Editor is checked, and then click the Install button.



To run System Policy Editor

- On the Start menu, click Run. Type **poledit** and then click OK.

If you want to use group policies, you must install that capability on each computer running Windows 95, either when you install Windows 95 using a custom setup script, or by using the Add/Remove Programs option in Control Panel.



To set up capabilities for group policies using Add/Remove Programs

1. In the Add/Remove Programs option in Control Panel, click the Windows Setup tab, and then click Have Disk button.
 2. In the Install From Disk dialog box, click Browse and specify the ADMIN\APPTOOLS\POLEDIT directory on the Windows 95 compact disc. Click OK, and then click OK again.
 3. In the Have Disk dialog box, make sure Group Policies is checked, and then click the Install button.
- Windows 95 Setup places GROUPOPOL.DLL in the Windows SYSTEM directory on the client computer and makes the required Registry changes.

For information about adding the ability to use group policies when installing Windows 95 using custom setup scripts, see [Custom, Automated, and Push Installations](#).

Using System Policy Editor

You can use System Policy Editor in two different modes: Registry mode and Policy File mode:

- In Registry mode, you can directly edit the Registry of the local or remote computer, and changes are reflected immediately. For more information about editing the Registry for a remote computer, see [Remote Administration](#).
- In Policy File mode, you can create and modify system policy files (.POL) for use on other computers. In this mode, the Registry is edited indirectly. Changes are reflected only after the policy is downloaded when the user logs on.



To use System Policy Editor in Registry mode

- In System Policy Editor, click the File menu, and then click Open Registry. Then, double-click the appropriate User or Computer icon, depending on what part of the Registry you want to edit. After you make changes, you must shut down and restart the computer for the changes to take effect.

System Policy Editor in Registry mode

Notice that the title bar shows "Local Registry."

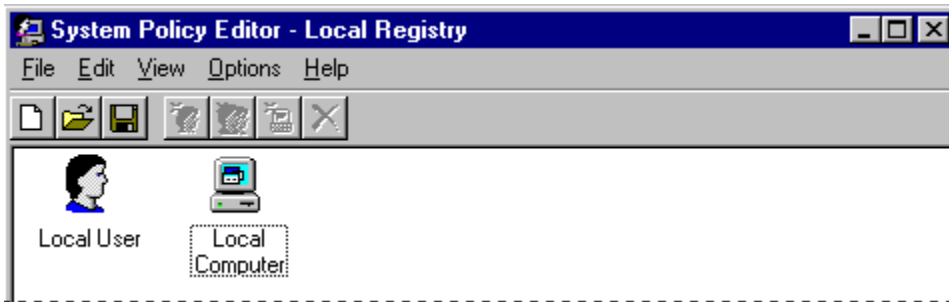

Important Use Registry mode only when you want to make direct changes to the Registry. You should typically change system settings by using the Control Panel options and other tools provided with Windows 95.



To use System Policy Editor in Policy File mode

- In System Policy Editor, click the File menu, and then click New or Open to open a policy file.

System Policy Editor in Policy File mode

The title bar shows the policy filename.

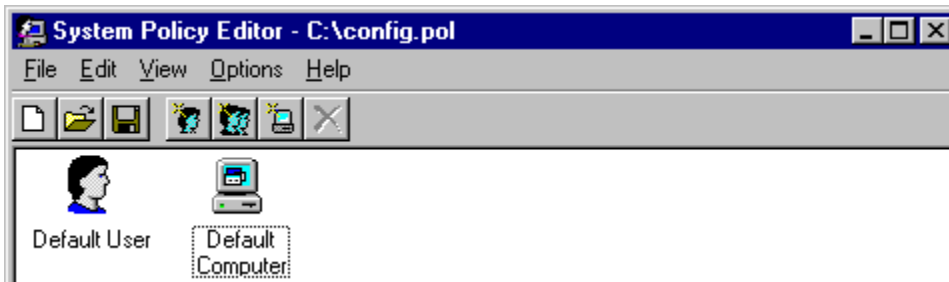

When you edit settings in Policy File mode, clicking a Registry option sets one of three possible states: checked, cleared, or grayed. Each time you click an option, the display cycles to show the next possible state. This is different from clicking a standard check box, which only sets an option to on or off. The following summarizes the three possible states for options in a policy file.

Option state	Meaning
<input type="checkbox"/>	Checked — this policy will be implemented, changing the state of the user's computer to conform to the policy when the user logs on. If the option was previously checked the last time the user logged on, Windows 95 makes no changes.
<input type="checkbox"/>	Cleared — the policy will not be implemented. If it was implemented previously (either through a policy setting or the user's configuration settings), the previously specified settings are removed from the Registry.
<input type="checkbox"/>	Grayed — the setting is unchanged from the last time the user logged on, and Windows 95 will make no related modifications to the system configuration. The grayed state ensures that Windows 95 provides quick processing at system startup because it does not need to process each entry each time a user logs on.

Caution When you define policy options, make sure you have set the proper state for the option. If you set an option by checking it, and then change your mind and clear the option, you can inadvertently destroy the user's previous configuration. If you decide not to set a particular policy option, make sure that option is grayed, so that the user's previous configuration for that setting will be used.

For example, you might check the option to specify Microsoft Client for NetWare Networks, and then click again to clear that option. When the user logs on and the policy is downloaded, this setting would wipe out the user's current configuration that specifies Client for NetWare Networks.

If a setting requires additional information, then an edit control appears at the bottom of the properties dialog box. For example, if Wallpaper is checked in the Desktop settings, the following dialog box appears.

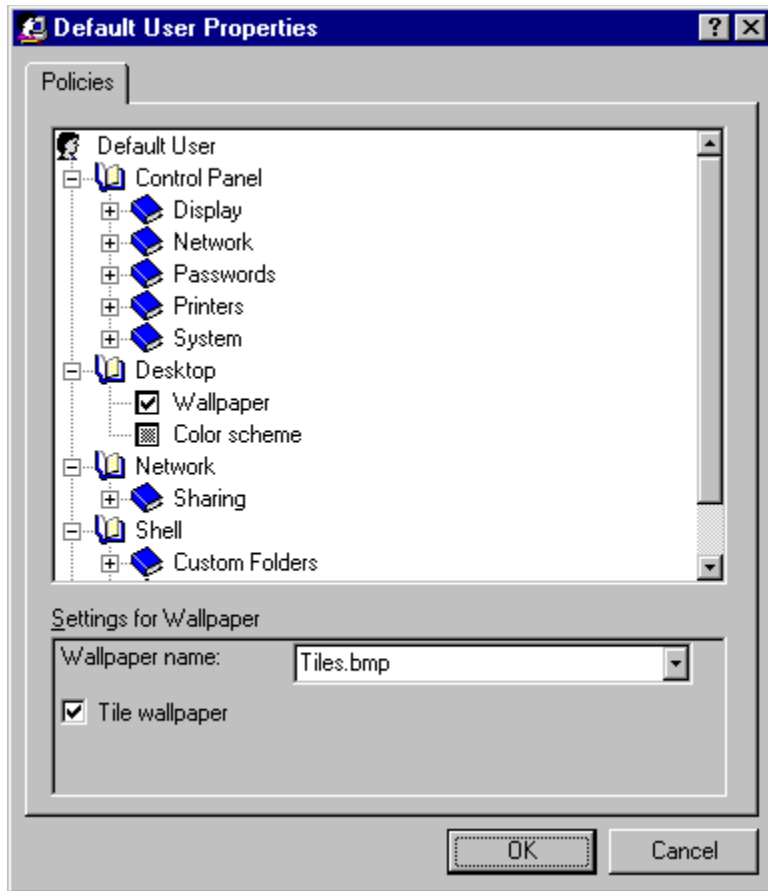

Usually, if a policy has been checked, and you no longer want to enforce it, you should clear the box to cancel the policy. However, in the following cases, a few policies might behave differently from how you might expect if the check box is cleared:

- The policy setting contains an edit box that must be completed (as opposed to a simple check box)
- The policy setting can also be set by users by using Control Panel

In these cases, you should consider making sure the check box is grayed when you no longer want to enforce the policies.

The following list describes the results of different settings for such policies and how they behave.

Policy	Behavior
Settings for Wallpaper	<ul style="list-style-type: none"> • Checking it forces the specified wallpaper to be used. • Clearing it removes the wallpaper (the user will not have any wallpaper). • Leaving it grayed means that the user can choose wallpaper in the Display option in Control Panel.
Client for NetWare Networks: Preferred Server	<ul style="list-style-type: none"> • Checking it sets the preferred server. • Clearing it deletes the preferred server from the computer's Registry. • Leaving it grayed means that the user can specify the preferred server in the Network option in Control Panel.
Microsoft Client for Windows	<ul style="list-style-type: none"> • Checking it sets the Windows NT Logon domain. • Clearing it deletes the domain setting from the

- Networks:
Domain
- computer's Registry.
 - Leaving it grayed means that the user can specify the domain in the Network option in Control Panel.
- Microsoft Client
for Windows
Networks:
Workgroup
- Checking it sets the workgroup for that computer.
 - Clearing it deletes the workgroup setting from the computer's Registry.
 - Leaving it grayed means that the user can specify the workgroup in the Network option in Control Panel.

User Profiles and System Policies

Preparing to Use System Policies on the Network

You can copy system policies from the network either manually or automatically. If you want to copy system policies automatically, Windows 95 locates the system policy file (CONFIG.POL) in the proper directory on the network and downloads its policy settings into the Registry of the local computer when the user logs on. If you want to copy system policies manually, Windows 95 copies the system policy file from a location you specify. Automatic downloading works only if the filename for the system policy file is CONFIG.POL.

Note Windows 95 supports automatic downloading for Windows NT and NetWare networks. The 32-bit, protected-mode network clients subsequently made available for other networks might also provide support for automatic downloading.

Setting Up for Automatic Downloading of System Policies

By default, Windows 95 downloads system policies automatically. However, if you switch to manual downloading, the following procedures describe how to return to automatic downloading.

If you created a .POL file, Windows 95 automatically downloads this file from the NETLOGON directory on a Windows NT network or from the PUBLIC directory on a NetWare network.



To set up for automatic downloading on Windows NT networks

1. In the Network option in Control Panel, make sure that Client for Microsoft Networks is specified as the Primary Network Logon client, and that the domain is defined. For more information, see [Logon, Browsing, and Resource Sharing](#).
2. Create the policy file to be downloaded and save it in the following location:
`\\primary domain controller\netlogon\config.pol`



To set up for automatic downloading on NetWare networks

1. In the Network option in Control Panel, make sure that Microsoft Client for NetWare Networks is specified as the Primary Network Logon client, and that a preferred server is specified in properties for the network client. For more information, see [Windows 95 on NetWare Networks](#).
2. Create the policy file to be downloaded and save it in the following location:
`\\preferred server\sys\public\config.pol`

For NetWare networks, the client computers must be running Microsoft Client for NetWare Networks. If the client computers are using NETX or VLM, then policies must be downloaded manually.

Important Make sure you place system policy files on the user's preferred server. Policy files are not available if they are stored on other NetWare servers or on computers running File and Printer Sharing for NetWare Networks.

Setting Up for Manual Downloading of System Policies

If you use the Remote Update policy, you can configure Windows 95 to manually download policy files (even when they are stored locally) by indicating a separate network or local computer location. Manual downloading overrides automatic downloading and allows you to choose where a user's policies should be stored.

It's possible to set up each computer for manual downloading individually, but this can be time-consuming. If possible (that is, when the client computers use 32-bit, protected-mode network clients), you should set up each computer for automatic downloading, and then use the Remote Update policy to point specific computers to other servers as appropriate for your environment and users.

However, for real-mode network clients such as Novell NETX or VLM, you must enable manual downloading on each computer. After you configure the client computer, the system policy file will be downloaded the next time the user logs on.



To configure a computer for manual downloading of system policies

1. In System Policy Editor, click the File menu, and then click Open Registry. Click Local Computer.

-Or -

In the File menu, click Connect. Type the name of the computer you want to configure remotely, and then click OK. Double-click the icon for that computer.

Note The remote computer must be running the Microsoft Remote Registry service, Remote Administration must be enabled, and user-level security must be enabled.

2. Double-click Network, double-click Update, and click Remote Update so that this policy is checked.

Note If the client computer uses NETX or VLM, the policy file must be placed on a mapped drive.

Make sure to type the UNC path and the filename in the Path For Manual Update box.

On Windows NT or NetWare networks where you are using automatic downloading of policies, you can set a system policy to allow manual downloading. This option works only after system policies have been downloaded automatically the first time after Windows 95 is installed. The first automatic downloading includes information in the system policies that defines the location to be used subsequently for manual downloading.



To define the location of policies for manual downloading

1. In System Policy Editor, open CONFIG.POL, and then double-click the Default Computer icon.
2. Double-click Network, then double-click Update, and then click Remote Update so that this policy is checked.
3. In the Update Mode box, click Manual. In the Path For Manual Update box, type the UNC path and filename for the system policy file you want to download. Make sure this file exists in the location you specify. (Otherwise, an error will result.)

On large networks, when thousands of users log on at the same time, all accessing the same policy file, you might experience slow network performance. To avoid a bottleneck, Windows 95 offers load balancing on Windows NT networks. With load balancing enabled, policies are taken from the logon server (which can be a domain controller or a backup domain controller) rather than the primary domain controller. This spreads the load over a number of servers, but it does require that you replicate the policy file on each server.



To enable load balancing

1. Perform the previous procedure, "To define the location of policies for manual downloading."
2. In the Settings For Remote Update box, make sure Load-Balance is checked.

If you want to use load balancing, make sure it is enabled on each client computer. Also, make sure you have a current policy file on each server that will participate in load balancing, including all Windows NT domain controllers and servers. One convenient way to implement load balancing is to

set this policy in the CONFIG.POL file that is on the primary domain controller. As each client computer downloads this policy, it will then subsequently look for CONFIG.POL on the logon server.

Creating System Policies

This section describes procedures for creating system policies.

To take advantage of automatic downloading discussed earlier, you should create a policy file that contains user, computer, and group entries to reside in the NETLOGON directory of a Windows NT server or the PUBLIC directory of a NetWare server. Based on the client selected, Windows 95 automatically looks in one of these locations to download your newly created system policy.



To view or edit default system policies

1. In System Policy Editor, click the File menu, and then click New File.
2. Double-click the Default User icon to define the default settings for user-specific policies.
-Or -
Double-click the Default Computer icon to define the settings for computer-specific policies.
3. Click the policies you want to put in place.

Creating Policies for Individual Users or Computers

This section describes how to create a system policy for a user or computer.

Tip To reduce the management load, minimize the number of user and computer entries in system policy files. Consider first creating one standard system policy for all users by editing default settings, and then create settings for individuals on an exception basis. For more information, see the STANDARD.POL example in [System Policy Examples](#).



To create system policies for a new user or computer

1. In System Policy Editor, click the Edit menu, and then click Add User or Add Computer.
2. Type the name of the user or computer you want to add.

System Policy Editor adds an icon for each user or computer that you add.



To edit existing system policies

1. In System Policy Editor, double-click the icon for the user or computer policies you want to edit.
2. Check or clear policies by clicking the policy name.

Creating Policies for Groups

Group policies are supported for both Windows NT and NetWare networks. Creating policies for groups is similar to the process for creating policies for users or computers.

You must first make sure that GROUPOP.DLL, which supports group policies, has been successfully installed on each client computer. For more information, see [System Policy Editor](#).

You cannot create new groups by using System Policy Editor; you can use only existing groups on the NetWare or Windows NT network. To create a new group, use the tools provided with your network administrative software.



To create system policies for groups

1. In System Policy Editor, click the Edit menu, and then click Add Group.
2. Type the name of the group you want to add, and click OK.

-Or -

If user-level security is enabled, click Browse and find the name of the group. Then click OK.

3. Click or clear policies by clicking the policy name.

Group policies are downloaded starting with the lowest priority group and ending with the highest priority group. All groups are processed. The group with the highest priority is processed last so that any the settings in that group's policy file supersede those in lower priority groups. You can use one policy file for each group, even if some of the client computers in the group don't have support installed for group policies. Client computers that aren't configured for using group policies will ignore group policy files.

Important If a policy exists for a specific named user, then group policies are not applied for that user.



To set priority levels for groups

1. In System Policy Editor, click the File Menu, and then click Open File.
2. Locate the CONFIG.POL file, and then click Open.
3. Click the Options menu, and then click Group Priority.
4. In the Group Priority dialog box, click a group, and then use the Move Up and Move Down buttons to move it into its relative priority.

Managing Custom Folders for Use with System Policies

The administrator can define five system policies to create a custom desktop. These policies use custom folders, created by the administrator, which contain the specific settings for the customized desktop. The following list summarizes the policies used to create a custom desktop.

Policy	Description
Custom Programs Folder	Shortcuts that appear in the Programs group on the Start menu
Custom Network Neighborhood	Shortcuts to resources that appear in Network Neighborhood, including shortcuts to shared printers and files and to Dial-Up Networking connections
Custom Desktop Icons	Shortcuts that appear on the desktop
Custom Start Menu	Shortcuts and other options that appear on the Start menu, as defined by using the Taskbar Properties dialog box
Custom Startup Folder	Programs or batch files that appear in the Startup group on the Start menu

Before you create a custom desktop by using system policies, you must define custom folders.



To define custom folders for use with policy files

1. Create and place the custom folders in a central location where users have access. You can use any valid folder names for the folders you create. Windows 95 uses the path defined for the related policy to find the folder.

Note To prevent accidental removal or unauthorized changes, you should place custom folders in directories where users are restricted to read-only access.

2. Place the custom set of files and shortcuts you want in each folder.
 - You can place any kind of files in the custom folders.
 - For shortcuts, make sure that the path specified in the Target box in Shortcut properties is a UNC name, rather than a mapped directory. Otherwise, the users who will access resources using these shortcuts will have to have the same drives mapped in their login scripts.

Caution Do not place folders in the custom Network Neighborhood. Windows 95 does not support this feature, and unpredictable results can occur.



To create a custom desktop by using system policies

1. In System Policy Editor, open the system policy file.
2. In the system policy file, set the related policies.
3. In the Path To Get Program Items From box, type the path to the folder's location.

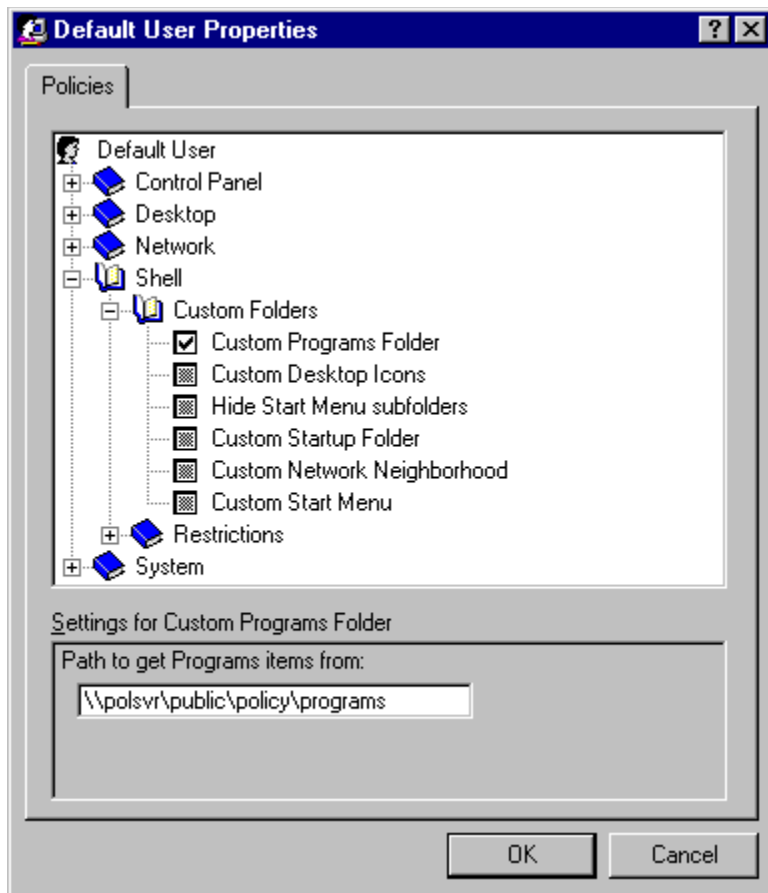

4. If you checked the Custom Programs Folder policy, also check the Hide Start Menu Subfolders policy to enable it.

Otherwise, multiple Programs entries will appear on the user's Start menu — one for the location of the Custom Program Folder and one for the default location.

If the custom folders will not be stored in the directories where Windows 95 automatically looks for them, then you must specify another location when you specify the Custom Folder policies. For example, you might want to create these folders where the system policy files are located on the server.

The following list shows the default locations for custom folders.

- Custom Program folders:
c:\windows\profiles\username\start menu\programs
- Custom desktop icons:
c:\windows\profiles\username\desktop
- Custom Startup folder:
c:\windows\profiles\username\start menu\programs\startup
- Custom Network Neighborhood:
c:\windows\profiles\username\nethood
- Custom Start menu:
c:\windows\profiles\username\start menu

System Policy Examples

The *Windows 95 Resource Kit* utilities provide you with two examples of system policies. STANDARD.POL is a policy file for defining a standard desktop. MAXIMUM.POL is a policy file for maximum security and control. These example policy files are ready for you to use after minor changes such as specifying paths and file locations for custom folders at your site.

Recommended Standard Desktop Configuration

The STANDARD.POL system policy file is an example of settings that allow you to implement a level of control over users' desktop functionality while allowing specific corporate customization. STANDARD.POL includes the following additions.

STANDARD.POL Settings

Category	Policy setting
----------	----------------

Computer settings:

Network Logon	Logon Banner (modify banner text as needed) Require Validation by Network for Windows Access
Network Passwords	Hide Share Passwords with Asterisks Minimum Windows Password Length (6)
System	Enable User Profiles

User settings:

Control Panel	Disable Deletion of Printer (printer restrictions)
System	Disable Registry Editing Tools ¹ Disable MS-DOS Prompt
Custom Folders ²	Custom Desktop Icons Custom Programs Folder Custom Startup Folder Custom Network Neighborhood Custom Start Menu Hide Start menu Subfolders (custom folders are defined)

¹ This setting disables only Registry Editor, not System Policy Editor.

² These options provide an opportunity for corporate customization, such as defining a program group containing corporate applications, applications that run at system startup, a custom Network Neighborhood, or a custom Start menu with standard choices.

To implement the custom settings specified in the STANDARD.POL policy file, make sure you define the UNC path names for the custom settings. Also make sure to place the customized folders for Programs, Startup, Network Neighborhood, and Start Menu in a secure network location, as described in [Managing Custom Folders for Use with System Policies](#).

Recommended Maximum Control Desktop Configuration

The system policy defined in MAXIMUM.POL is useful if you need to have as much control as possible over the users' computing environments. The following sample policy file will assist you in establishing the highest possible level of control.

MAXIMUM.POL is based on the STANDARD.POL file, as described in the previous section, with the following additional restrictions.

Additional MAXIMUM.POL Settings

Category	Policy setting
-----------------	-----------------------

Computer settings:

Network Dial-Up	Disable Dial-In
-----------------	-----------------

User settings:

Control Panel	Disable Display Control Panel (display restrictions)
---------------	--

Restrict System	Hide Device Manager Page
-----------------	--------------------------

Control Panel	Hide Hardware Profiles Page
---------------	-----------------------------

	Hide File System Button
--	-------------------------

	Hide Virtual Memory Button
--	----------------------------

Network Sharing	Disable File Sharing Controls
-----------------	-------------------------------

	Disable Print Sharing Controls
--	--------------------------------

Shell Restrictions	Remove Run Command
--------------------	--------------------

	Remove Folders from Settings on Start Menu
--	--

	Remove Taskbar from Settings on Start Menu
--	--

	No Entire Network in Network Neighborhood
--	---

	No Workgroup Contents in Network Neighborhood
--	---

	Don't Save Settings at Exit
--	-----------------------------

System Policy Settings Summary

This section summarizes the policy options that you can set by default in Windows 95. These options are determined by a template (ADMIN.ADM), which can be modified as discussed in [System Policy Templates](#). You might find it helpful to run System Policy Editor while you study these options.

These policies are described in the order that they appear in System Policy Editor. For each category, you must click the option that appears in bold type to display the related policies that you can define for that category.

User Profiles and System Policies

System Policy Settings Summary

Restricting Access to User-Specific Settings

When you double-click the Default User icon in System Policy Editor, a list of Control Panel, desktop, network, shell (user interface), and system settings appears so that you can predefine or restrict access to settings that will apply when the user logs on to the system. These system policy settings are stored in USER.DAT.

Restricting Access to Control Panels

The following table describes the system policies you can apply to restrict access to settings in the Display, Network, Printers, System, and Passwords options of Control Panel.

User Policies for Restricting Access to Control Panel Options

Option	Description
--------	-------------

Restrict Display Control Panel

Disable Display Control Panel	Prevents access to the Display option in Control Panel.
Hide Background Page	Hides the Background properties of the Display option in Control Panel.
Hide Screen Saver Page	Hides the Screen Saver properties of the Display option in Control Panel.
Hide Appearance Page	Hides the Appearance properties of the Display option in Control Panel.
Hide Settings Page	Hides the Settings properties of the Display option in Control Panel.

Restrict Network Control Panel

Disable Network Control Panel	Prevents access to the Network option in Control Panel.
Hide Identification Page	Hides the Identification properties of the Network option in Control Panel.
Hide Access Control Page	Hides the Access Control (user level vs. share level) properties of the Network option in Control Panel.

Restrict Passwords Control Panel

Disable Passwords Control Panel	Prevents access to the Passwords option in Control Panel.
Hide Change Passwords Page	Hides the Change Passwords properties of the Passwords option in Control Panel.
Hide Remote Administration Page	Hides the Remote Administration properties of the Passwords option in Control Panel.
Hide User Profiles Page	Hides the Profiles properties of the Passwords option in Control Panel.

Restrict Printers Settings

Hide General And Details Pages	Hides the General and Details properties for the Printer option in Control Panel.
Disable Deletion Of Printers	Prevents the deletion of installed printers.
Disable Addition Of Printers	Prevents the installation of printers.

Restrict System Control Panel

Hide Device Manager Page	Hides the Device Manager properties from the System option in Control Panel.
Hide Hardware	Hides the Hardware Profiles properties from the System

Profiles Page	option in Control Panel.
Hide File System Button	Hides the File System button from the Performance properties in the System option in Control Panel.
Hide Virtual Memory Button	Hides the Virtual Memory button from the Performance properties in the System option in Control Panel.

User Profiles and System Policies

System Policy Settings Summary

Restricting Access to User-Specific Settings

Defining User Policies for Desktop Settings

Within this category of options, you can predefine settings or restrict users from defining wallpaper and color scheme settings, as listed in the following table.

User Policies for Wallpaper and Color Scheme Settings

Option	Description
Wallpaper Name	When checked, the specified bitmap will be used as the wallpaper.
Tile Wallpaper	When checked, the wallpaper file will be tiled in the background of the desktop.
Color Scheme	When checked, the user will automatically see the specified color scheme.

User Profiles and System Policies

System Policy Settings Summary

Restricting Access to User-Specific Settings

Restricting Access to Network Settings

Within this category of options, you can restrict the user's ability to share files and printers. Typically, you might want to set these policies to apply when File and Printer Sharing services are installed, but when you do not want users to change which resources are shared on their computers.

User Policies for Restricting Access to File and Printer Sharing

Option	Description
Sharing	
Disable File Sharing Controls	Removes the Sharing properties from directories in Windows Explorer.
Disable Print Sharing Controls	Removes the Sharing properties from the Printer directory.

Restricting Access to Shell Settings

The following table describes the system policies you can apply to directories and user interface options.

User Policies for Restricting Access to Shell Settings

Option	Description
Custom Folders	
Custom Programs Folder	Customizes the contents of the Programs directory. You must also type a path for the directory containing complete files or .LNK files that define the Programs directory items.
Custom Desktop Icons	Customizes desktop icons. You must also type a path for the directory containing complete files or .LNK files that define the desktop shortcuts.
Hide Start Menu Subfolders	Check this when you use a custom Programs folder. Otherwise, two Programs entries will appear on the user's Start menu.
Custom Startup Folder	Customizes the contents of the Startup directory. You must also type a path for the directory containing complete files or .LNK files that define the Startup directory items.
Custom Network Neighborhood	Customizes the contents of Network Neighborhood. You must also type a path for the directory containing complete files or .LNK files that define the Network Neighborhood items.
Custom Start Menu	Customizes what is listed on the Start menu. You must also type a path for the directory containing complete files or .LNK files that define the Start menu items.
Restrictions	
Remove Run command	Prevents access to the Run command on the Start menu.
Remove Folders From Settings On Start Menu	Prevents access to any item listed under Settings on the Start menu.
Remove Taskbar From Settings On Start Menu	Prevents access to the Taskbar item listed under Settings on the Start menu.
Remove Find Command	Prevents access to any of the items listed under Find on the Start menu.
Hide Drives In My Computer	Prevents access to My Computer.
Hide Network Neighborhood	Prevents access to Network Neighborhood.
No Entire Network In Network Neighborhood	Prevents access to the Entire Network icon in Network Neighborhood.
No Workgroup Contents In	Prevents workgroup contents from being displayed in Network Neighborhood.

Network

Neighborhood

Hide All Items On Desktop Prevents access to all items on the desktop.

Disable Shut Down Command Prevents access to the Shut Down command on the Start menu; displays explanation in a dialog box.

Don't Save Settings At Exit Prevents settings from being written to the file system.

User Profiles and System Policies

System Policy Settings Summary

Restricting Access to User-Specific Settings

Restricting Access to System Settings

The system policies in this category restrict the use of Registry editing tools, applications, and MS-DOS-based applications. The following table describes the policies you can set within this category.

User Policies Restricting Access to System Settings

Option	Description
Restrictions	
Disable Registry Editing Tools	Prevents access to Registry Editor. It does not prevent access to the Registry mode in System Policy Editor.
Only Run Allowed Windows Applications	Prevents users from running any Windows-based applications except those that are listed. Click Show to define the allowed applications.
Disable MS-DOS Prompt	Prevents access to the MS-DOS prompt.
Disable Single-Mode MS-DOS Applications	Prevents users from running MS-DOS-based applications in MS-DOS Mode.

User Profiles and System Policies

System Policy Settings Summary

Restricting Access to Computer-Specific Settings

When you double-click the Default Computer icon in System Policy Editor, a list of system policy options for settings that apply to the computer appears. This section describes these options.

Restricting Access to Computer-Specific Network Settings

This category of options includes system policy settings for the following:

- Enabling user-level security
- Logon dialog box settings
- Client for Microsoft Networks settings
- Microsoft Client for NetWare Networks settings
- Password settings
- Dial-Up Networking settings
- Sharing settings
- Simple Network Management Protocol (SNMP) settings
- Update settings for policy downloading

These system policies are applied for the computer and are stored in SYSTEM.DAT. The following table describes the system policies you can set within this category.

Computer Policies Restricting Access to Network Settings

Option	Description
--------	-------------

Access Control

User-Level Access Control	When checked, enables user-level security on the local computer using pass-through logon validation by a Windows NT or a NetWare server. You must specify the server and the type of authenticator for validation.
---------------------------	--

Logon

Logon Banner	When checked, allows you to specify text for a caption and other text to be displayed in a logon banner.
--------------	--

Require Validation By Network For Windows Access	When you check this option, each logon must be validated by a server before access to Windows is allowed. This policy has no effect on a portable computer after it is undocked.
--	--

Microsoft Client for NetWare Networks

Preferred Server	When checked, allows you to specify the name of the NetWare network server used by this computer as the first server logged on to.
------------------	--

Support Long Filenames	When checked, allows support for long filenames. The values are 0 (no support for long filenames on NetWare servers), 1 (support on NetWare servers version 3.12 and greater), and 2 (support if the NetWare server supports long filenames).
------------------------	---

Search Mode	Sets NetWare search mode (the value is 0-7).
-------------	--

Disable Automatic NetWare Login	Specifies that Windows 95 should not first silently use the user's name and password to attempt to connect to a NetWare server, which is the default behavior.
---------------------------------	--

Microsoft Client for Windows Networks

Log On To Windows NT	When checked, specifies that this computer can participate in a Windows NT domain. Type the name of the domain. If this option is checked, the next two options are also available.
----------------------	---

Display Domain	When checked, displays a message when the domain
----------------	--

Logon Validation	controller has validated user logon.
Disable Caching Of Domain Password	When checked, specifies that no caching is used for the network password.
Workgroup	When checked, specifies that this computer can participate in a workgroup. Type the name of the workgroup.
Alternative Workgroup	Specifies that an alternate workgroup must be defined to see Microsoft peer servers in other workgroups if your workgroup does not have any computers running File and Printer Sharing for Microsoft Networks (that is, they all run File and Printer Sharing for NetWare), but the computer runs a Microsoft network client. The workgroup specified should include at least one computer running File and Printer Sharing for Microsoft Networks.

File and Printer Sharing for NetWare Networks

Disable SAP Advertising	When checked, specifies that this computer can never use SAP Advertising. Set this option if you do not want peer servers to be seen by NETX or VLM clients.
-------------------------	--

Passwords

Hide Share Passwords With Asterisks	Replaces characters with asterisks when users type passwords to access a shared resource. Applies to share-level security only; this setting is on by default.
Disable Password Caching	Prevents saving passwords. (Notice that the user cannot successfully use the Quick Logon feature for Microsoft networks if password caching is disabled.)
Require Alphanumeric Windows Password	Requires that the Windows password contain a combination of letters and numbers.
Minimum Windows Password Length	Requires that the Windows logon password has at least the specified number of characters.

Dial-Up Networking

Disable Dial-In	Prevents dial-in connections to the computer.
-----------------	---

Sharing

Disable File Sharing	Prevents file sharing over a network.
Disable Print Sharing	Prevents printer sharing over a network.

SNMP

Communities	Specifies one or more groups of hosts to which this computer belongs for purposes of SNMP administration. These are the communities that are allowed to query the SNMP agent.
Permitted Managers	Specifies IP or IPX addresses allowed to obtain information from an SNMP agent. If this policy is not checked, any SNMP console can query the agent.
Traps For Public Community	Specifies <i>trap destinations</i> , or IP or IPX addresses of hosts in the public community to which you want the SNMP service to send traps.

For information about sending traps to other communities, see [Remote Administration](#).

Internet MIB (RFC 1156) Allows you to specify the contact name and location if you are using Internet MIB.

Update

Remote Update Defines how system policies will be updated. When checked, the following options appear.

Update Mode Determines whether system policies are downloaded automatically (the default) or manually.

Path For Manual Update Specifies the UNC path and filename for manual downloading of system policies.

Display Error Message When a user logs on, if the system policy file is not available, displays an error message.

Load-Balance For Windows NT networks, allows Windows 95 to look for policy files on that server.

Restricting Access to Computer-Specific System Settings

This category of options includes system policy settings for the network path for setup and user profiles. The following table describes the system policies you can set within this category.

Computer Policies for System Settings

Option	Description
Enable User Profiles	When checked, this setting enables user profiles.
Network Path For Windows Setup	Defines the network location of the Windows 95 Setup program and files. You must also type a UNC path for the setup directory.
Run	Defines applications and utilities to run when the user logs on. Click Show to specify items to run.
Run Once	Defines applications and utilities to run once when the user logs on. Click Show to specify items to run. (See comment below.)
Run Services	Defines services to run at system startup. Click Show to specify items to run.

You can set the Run Once system policy to set values in the Run Once Registry key, which allows any executable file to be run just once after a user logs on to the computer. After the related program is started, its name is removed automatically from the Registry so that it does not run again. However, if you leave this option checked in the policy file, then each time the user logs on, that executable name will be placed in the Run Once Registry key to be run again. To ensure that the executable runs only once, the policy must be checked only long enough to be downloaded once into the user's Registry. Then the policy must be cleared or changed so that the same Run Once entry will not run the next time the user logs on.

System Policy Templates

When you run System Policy Editor, Windows 95 opens the default policy template, which contains existing policies that you can enable or modify. A template is a listing of the possible policies that you can use. By default, this template file is named ADMIN.ADM and is stored in the Windows INF directory.

This section describes how you can create custom system policy templates (.ADM files) and switch between multiple templates in System Policy Editor.

For example, it might be helpful to have system policy settings for corporate-specific applications, such as an in-house database, custom front end, or electronic mail package. After a template has been customized, you can then load the template and use it to set values in the Registry.

Note If you want to define system policies for applications, the applications must be able to read the Windows 95 Registry.

Creating your own template is helpful when you want to define a specific set of Registry settings in your system policies, including settings not definable by default through System Policy Editor. As shown in the following illustration, the template defines the policies you can set through System Policy Editor. Changes you make there are reflected in the policy file (shown in the example as CONFIG.POL), which in turn updates the Registry when the user logs on.

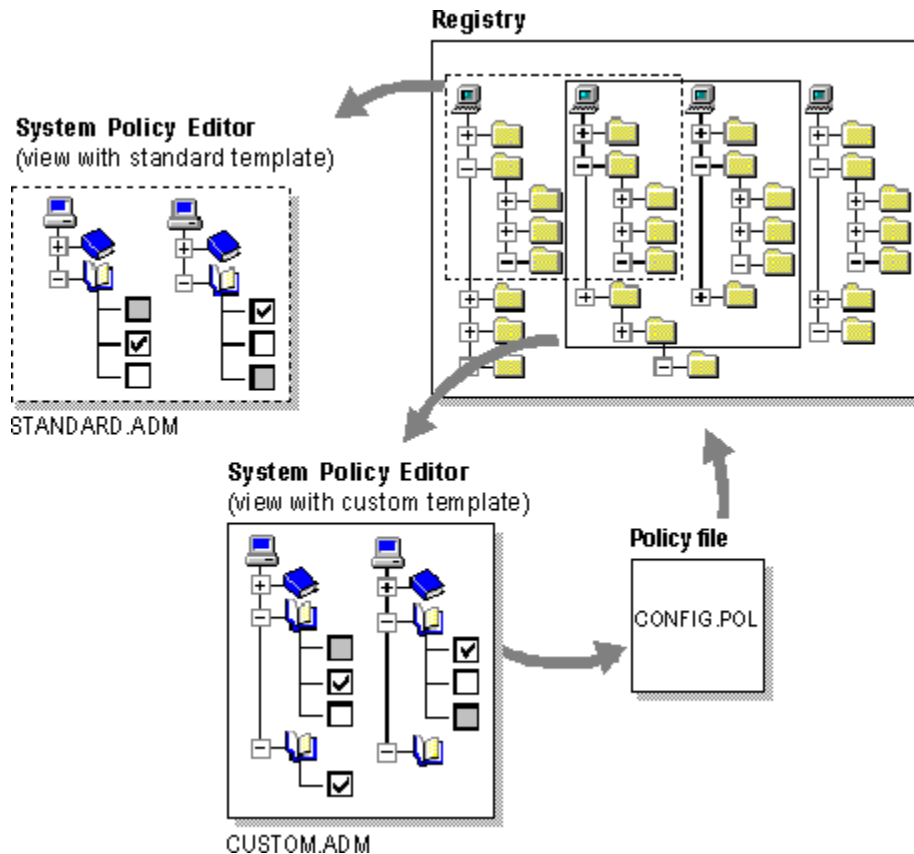

To use a template other than the default template

1. In System Policy Editor, make sure all policy files are closed.
2. On the Options menu, click Template.
3. Click Open Template, and select an .ADM file to be your template to begin setting system policies. Click Open.

4. Click Close to return to System Policy Editor.

You can create your own templates that can be read by System Policy Editor. Users can then load the template and use it to set values in the Registry. To create a template, use a text editor such as WordPad to edit or write an .ADM file. You can open the default template named ADMIN.ADM in the Windows INF directory to use as an example.

A template uses several key words, syntaxes, and symbols, as summarized in the following list.

- **Class:**
CLASS *category_type*
- **Category:**
CATEGORY *name*
 [KEYNAME *key_name*]
 [... *policy definition statements* ...]
END CATEGORY
- **Policy:**
POLICY *name*
 [KEYNAME *key_name*]
 [... *part definition statements* ...]
END POLICY
- **Part:**
PART *name part_type*
 type-dependent data
 [KEYNAME *key_name*]
 VALUENAME *value_name*
END PART

The following table describes the keywords in system policy templates. Following this table are lists of the controls and values that can be defined in templates.

System Policy Template Key Words

Template key word	Description
-------------------	-------------

CLASS	Defines the Registry key that can be edited; the value must be USER or MACHINE, corresponding to Hkey_Current_User or Hkey_Local_Machine, respectively.
CATEGORY <i>name</i>	Defines a category in System Policy Editor. If a <i>name</i> contains spaces, it must be enclosed in quotes. A category statement can appear only once for each category name.
END CATEGORY	Defines the end of a category and all of its policies.
POLICY <i>name</i>	Defines a policy within a category. Policy names that contain spaces must be enclosed in quotes.
END POLICY	Defines the end of a policy and all its parts.
PART <i>name</i>	Defines one or more controls that can be used to set the values of a policy. Part names that contain spaces must be enclosed in quotes. Policy part types and type-dependent data are described in the following tables.
END PART	Defines the end of the control list.
VALUEON	Specifies the setting to assign to the value when the policy is checked.
VALUEOFF	Specifies the setting to assign to the value when it is

	not checked.
<i>KEYNAME</i>	Specifies the full path of the Registry key. This is an optional Registry key name to use for the category or policy. If there is a key name specified, it is used by all child categories, policies, and parts, unless they define a key name of their own.
<i>VALUENAME</i>	Defines the Registry value entry name.
<i>VALUE</i>	Specifies the Registry value to set to a <i>VALUENAME</i> .
!!	Indicates a string value.
[strings]	Defines a section containing string values.

A system policy template uses the following part control indicators.

System Policy Template Part Control Indicators

Part Control Indicator	Description
CHECKBOX	Displays a check box. The value is nonzero if checked by the user, and its value entry is deleted if it is unchecked.
NUMERIC	Displays an edit field with an optional spin control that accepts a numeric value.
EDITTEXT	Displays an edit field that accepts alphanumeric text.
COMBOBOX	Displays a combo box, which is an edit field plus a drop-down list for suggested values.
TEXT	Displays a line of static (label) text. There is no Registry value associated with this part type.
DROPDOWNLIST	Displays a drop-down list. The user can choose from only one of the entries supplied. The main advantage of a drop-down list is that, based on the user's selection, a number of extra Registry edits can be performed.
LISTBOX	Displays a list box with Add and Remove buttons. This is the only part type that can be used to manage multiple values under one key.

A system policy template uses the following type-specific information.

System Policy Template Type-Specific Information

Type-specific modifier	Description
CHECKBOX:	
DEFCHECKED	Causes the check box initially to be checked.
VALUEON	If specified, overrides the default "on" behavior of the check box. For example: VALUEON "On" writes "On" to the Registry.
VALUEOFF	If specified, overrides the default "off" behavior of the check box. For example: VALUEOFF "Off" writes "Off" to the Registry.
ACTIONLISTON	Specifies optional action list to be taken if check box is "on."
ACTIONLISTOFF	Specifies optional action list to be taken if check box is "off."

NUMERIC:

DEFAULT <i>value</i>	Specifies initial numeric value for the edit field. If this statement is not specified, the edit field is initially empty.
MIN <i>value</i>	Specifies minimum value for number. Default value is 0.
MAX <i>value</i>	Specifies maximum value for number. Default value is 9999.
SPIN <i>value</i>	Specifies increments to use for a spin control. Specifying SPIN 0 removes the spin control; SPIN 1 is the default.
REQUIRED	If specified, System Policy Editor will not allow a policy containing this part to be enabled unless a value has been entered.
TXTCONVERT	Writes values as strings rather than binary values.

EDITTEXT:

DEFAULT <i>value</i>	Specifies the initial string to place in the edit field. If this is not specified, the field is empty initially.
MAXLEN <i>value</i>	Specifies the maximum length of the string in the edit field.
REQUIRED	If specified, System Policy Editor will not allow a policy containing this part to be enabled unless a value has been entered.

COMBOBOX:

	Accepts all the key words that EDITTEXT does, plus SUGGESTIONS.
SUGGESTIONS	Begins a list of suggestions to be placed in the drop-down list. Suggestions are separated with spaces and can be enclosed by quotes. The list is terminated with END SUGGESTIONS. For example:

```
SUGGESTIONS
Alaska Alabama Mississippi "New York"
END SUGGESTIONS
```

TEXT:

Contains no type-specific data.

DROPDOWNLIST:

REQUIRED	If specified, System Policy Editor will not allow a policy containing this part to be enabled unless a value has been entered.
----------	--

ITEMLIST	Begins a list of the items in the drop-down list. The end of the list must be terminated by END ITEMLIST. Each item in the list is specified as follows:
----------	--

```
NAME name VALUE value
[ACTIONLIST actionlist]
. . .
```

name is the text to be displayed in the related drop-down list.

value is the value to be written for the part's value if this item is selected. Values are assumed to be strings, unless they are preceded by the key word NUMERIC.

For example:

```
VALUE "Some value"  
VALUE NUMERIC 1
```

If the VALUE key word is followed by the DELETE key word (that is, VALUE DELETE), then this Registry name/value pair will be deleted.

actionlist is an optional list to be used if this value is selected.

LISTBOX:

VALUENAME	Cannot be used with the list box type, because there is no single value name associated with this type. By default, only one column appears in the list box, and for each entry a value is created with an identical value name and value data. For instance, the List Entry value in the list box would create a value named "List Entry" containing "List Entry" as data.
VALUEPREFIX <i>prefix</i>	Defines the prefix to be used in determining value names. If a prefix is specified, then this prefix plus "1," "2," and so on will be used instead of the default value naming scheme listed earlier in this table. The prefix can be empty (" "), which will cause the value names to be "1," "2," and so on. A prefix of SomeName will generate value names "SomeName1," "SomeName2," and so on.
EXPLICITVALUE	Causes the user to specify the value data and the value name. The list box shows two columns for each item, one for the name and one for the data. This key word cannot be used with the VALUEPREFIX key word.
ADDITIVE	If specified, values set in the list box are added to whatever values exist in the target Registry. Existing values are not deleted; by default, the content of list boxes will "override" whatever values are set in the target Registry. Specifically, a control value is inserted in the policy file which causes existing values to be deleted before the values set in the policy file are merged.

Strings:

!!	Indicates a string value. For example: <pre>!!StrConst</pre>
[<i>strings</i>]	Defines a section of string values; the values are defined in the following format: <pre>var_name=string value</pre> <p>For example:</p> <pre>StrConst="Control Name"</pre>
Comments	Can be added by preceding the line with a semicolon (;).

The following example shows a template that uses all the types of controls. This sample .ADM file is included with the *Windows 95 Resource Kit* utilities.

```
CLASS USER  
CATEGORY "Control Category 1"
```

```

KEYNAME KeyName1
POLICY "Policy1"
    ; actions to take when policy is checked
    ACTIONLISTON
        KEYNAME KeyName1
        VALUENAME Checked1    VALUE "AAA"
        VALUENAME Checked2    VALUE "BBB"
        VALUENAME Checked3    VALUE "CCC"
        KEYNAME KeyName2
        VALUENAME Unchecked1   VALUE DELETE
        VALUENAME Unchecked2   VALUE DELETE
        VALUENAME Unchecked3   VALUE "not checked"
    END ACTIONLISTON
    ; actions to take when policy is unchecked
    ACTIONLISTOFF
        KEYNAME KeyName1
        VALUENAME Checked1    VALUE ""
        VALUENAME Checked2    VALUE ""
        VALUENAME Checked3    VALUE ""
        KEYNAME KeyName2
        VALUENAME Unchecked1   VALUE "AAA"
        VALUENAME Unchecked2   VALUE "BBB"
        VALUENAME Unchecked3   VALUE "CCC"
    END ACTIONLISTOFF
END POLICY
POLICY "CheckBox"
    PART "CheckBox1:" CHECKBOX DEFCHECKED
        VALUENAME "CheckBox Control"
        VALUEON "is checked" VALUEOFF "is not checked"
    END PART
END POLICY
END CATEGORY
CATEGORY "Control Category 2"
KEYNAME KeyName3
POLICY "Static and Spin"
    PART "Below is a spin control" TEXT
    END PART
    PART "Spin:" NUMERIC SPIN 10 REQUIRED
    MAX 110
    VALUENAME "Spin"
    END PART
END POLICY
CATEGORY "Sub Category 1"
KEYNAME KeyName4
POLICY "ComboBox"
    PART "Combo:" COMBOBOX
    SUGGESTIONS
        One Two Three Four
    END SUGGESTIONS
    VALUENAME "Combo Control"
    END PART
END POLICY
POLICY "Drop Down List"
    PART "DropDown" DROPDOWNLIST
    VALUENAME DropDown REQUIRED
    ITEMLIST
        NAME "Name One" VALUE "Value One"
    ACTIONLIST
        VALUENAME "Value Name 1"    VALUE "Value 1"
        VALUENAME "Value Name 2"    VALUE "Value 2"

```

```

END ACTIONLIST
NAME "Name Two" VALUE "Value Two"
ACTIONLIST
    VALUENAME "Value Name 1"    VALUE DELETE
    VALUENAME "Value Name 2"    VALUE DELETE
END ACTIONLIST
NAME "Name Three" VALUE NUMERIC 333
NAME "Name Four" VALUE "Value Four"
END ITEMLIST
END Part
END POLICY
END CATEGORY
POLICY "Edit"
    PART "Edit" EDITTEXT
    MAXLEN 10
    VALUENAME Edit
    DEFAULT "Edit Default"
END Part
END POLICY
POLICY "List Box"
KEYNAME KeyName5
    PART "List Box Control" LISTBOX EXPLICITVALUE
END PART
END POLICY
END CATEGORY

```

The following shows the policies created by this sample .ADM file as they appear in System Policy Editor.

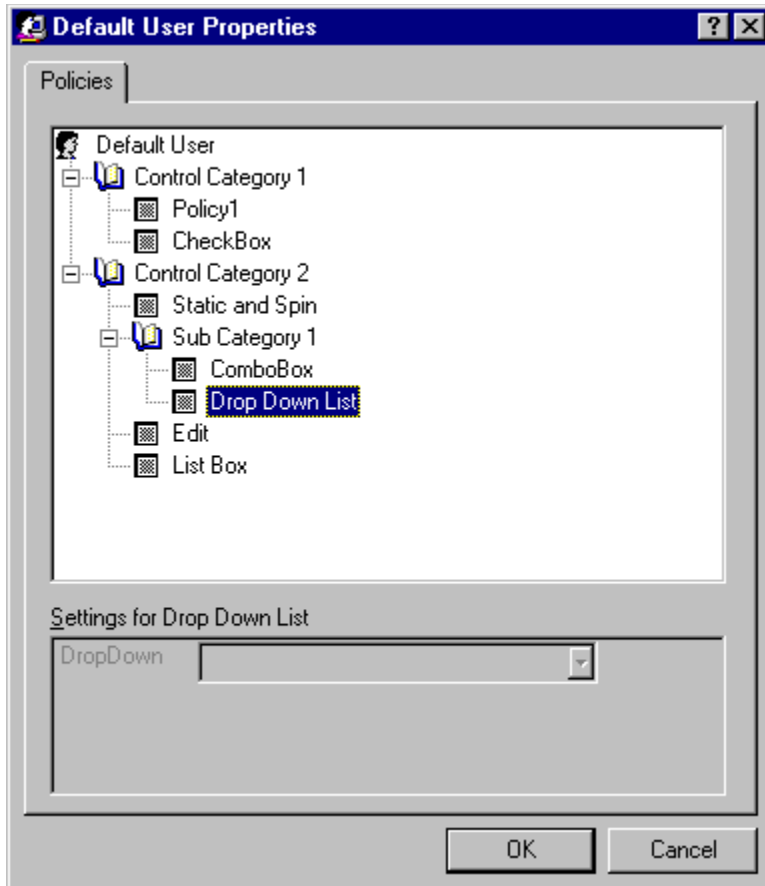

Troubleshooting with System Policy Editor

This section contains some common problems that you might encounter when implementing system policies and some suggestions for fixing those problems.

In general, when troubleshooting problems with system policies, verify the following:

- The related Registry key is correct in the policy template (.ADM) file.
- The related policy is set properly in the policy (.POL) file.
- The related application actually uses the Registry key being changed.
- The policy file is located in the correct network location, and the network location is accessible from the computer running Windows 95.
- For group policies, the user name, group name, and computer name are correct, and the user is a member of the specified group.

When troubleshooting system policies, you should turn on error messages. You can do this from the Remote Update policy, as explained in [Setting Up for Manual Downloading of System Policies](#). This setting displays error messages when policies cannot be downloaded correctly; the error messages might help identify the problem.

The computer seems to be picking up some of the policies, but not all of them.

In this case, the computer might not be picking up any policies for Default User or for a particular user; it might be picking up only policies set for Default Computer or for a particular computer. In this case, make sure that user profiles are enabled on that computer. In the Passwords option in Control Panel, click the User Profile tab and set the desired options.

The computer does not seem to be picking up policies from a CONFIG.POL file on the Windows NT domain.

- Make sure that there is a CONFIG.POL file in the NETLOGON directory on the primary domain controller on the Windows NT network.
- Make sure that the client computer has its domain set properly in the properties for Client for Microsoft Networks in the Network option in Control Panel.
- Make sure that the client computer is successfully logging on to that domain.
- Make sure that the client computer is configured for automatic policy downloading. You can set this by using the Remote Update policy, as described in [Setting Up for Manual Downloading of System Policies](#). Windows 95 is configured for automatic policy downloading by default.
- Enable error messages on the client computer and see if an error message is displayed.

The computer running Microsoft Client for NetWare Networks does not seem to be picking up the policies from a CONFIG.POL file on the NetWare server.

- Make sure that there is a CONFIG.POL in the PUBLIC directory on the SYS: volume of a NetWare 3.x or 4.x server. You cannot put the CONFIG.POL file on a computer running Windows 95 with File and Print Sharing for NetWare Networks.
- Make sure that the client computer has its Preferred Server set to the NetWare server that contains CONFIG.POL. This setting is located in the properties for Client for NetWare Networks in the Network option in Control Panel.
- Make sure that the client computer is successfully logging on to that preferred server.
- Make sure that the client computer is configured for automatic policy downloading. You can set this by using the Remote Update policy, as described in [Setting Up for Manual Downloading of System Policies](#).
- Enable error messages on the client computer and see if an error message is displayed.

The computer running a Novell-supplied VLM or NETX client does not seem to be picking up the policies from the CONFIG.POL on the NetWare server, even though the file is in SYS:PUBLIC.

Automatic downloading of system policies on a NetWare server works only when the client computer is running Microsoft Client for NetWare Networks. If the computer is running the Novell-supplied VLM or NETX client, then you must use manual downloading from a mapped drive. For information, see

Setting Up for Manual Downloading of System Policies.

The client computer is set for manual downloading, but it is not picking up the policies.

- Make sure that the path specified for manual downloading includes the name of the policy file itself.
- Make sure that the directory in which you placed the policy file can be accessed by the user that is logging on to the computer running Windows 95.

You have implemented a policy and then cleared it, but it appears to still be in effect, or it does not do what you thought it would do.

Does the policy have an edit box that needs to be completed? For example, do you need to specify the wallpaper or workgroup name? If so, then by clearing the policy, you are actually deleting the Registry setting for that value. For example, by clearing the wallpaper policy, the wallpaper Registry setting is made to be blank, and thus the user will have no wallpaper.

For all policies that involve settings that users can manipulate by using an option in Control Panel, the best way to stop enforcing that policy is to make sure that policy setting is grayed, in order to allow the users to make their own choices. These policies are listed in System Policy Editor.

You set up group policies, but one or more of the users do not get these group policies when they log on.

- Is there a policy for that particular user? If so, then group policies are ignored by design. This allows you to make exceptions to group policies for particular users.
- Make sure that the client computer is set up for group support.
- Make sure that the user or users are really members of that group.
- Make sure that user profiles are enabled on the client computer.

You used the policy named Only Run Allowed Windows Applications, but then you could not turn off this policy because you forgot to include POLEDIT.EXE in the list.

- Did you set this policy for all users? If not, then log on as another user, and run System Policy Editor to cancel this policy.
- If you can run Registry Editor, go to the following key and delete the RestrictRun entry:
`Hkey_Current_User\Software\Microsoft\Windows\CurrentVersion\Policies\Explore`
- If you previously set this policy for the Default User and, as a result, no user can run System Policy Editor or Registry Editor, then try the following:
 - If possible, disable user profiles in the Passwords option in Control Panel. Then you should be able to log on and run System Policy Editor. Then undo the policy and re-enable user profiles.
 - If you cannot disable user profiles because the Passwords option in Control Panel has been disabled, you must either reinstall Windows 95 (so that user profiles will not be enabled). Or use the Windows 95 startup disk and run the real-mode Registry Editor to disable user profiles.

You need to prevent users from modifying their computer configuration, including even more restrictions than are available through standard system policies.

Use one or more of the following methods for ensuring administrative control of the computer's configuration.

- In MSDOS.SYS for the user's computer, set **BootKeys=1** so the user cannot press F8 to avoid starting Windows 95. In addition, make sure that floppy-disk startup is not enabled in the computer's CMOS settings, and use password protection to prevent CMOS modifications. For information about making these changes, see the documentation from your computer's manufacturer.
- For the Registry on the user's computer, use System Policy Editor to enable the Registry setting named Require Validation By Network For Windows Access.
- In the system policies that are downloaded when the user logs on, set the policy named Disable Registry Editing Tools.
- Set the policy named Only Run Allowed Windows Applications, and make sure that System Policy Editor and Registry Editor are not on the list of allowed applications.
- Set up the user's computer to run Windows 95 as a shared installation, as described in Server-Based Setup for Windows 95.

Introduction

This chapter describes the Windows 95 management features that allow you to manage network computers from your own computer. This chapter also includes information about system management applications and agents, plus network backup agents from other vendors.

- [Remote Administration: The Basics](#)
- [Remote Administration: The Issues](#)
- [Setting Up for Remote Administration](#)
- [Accessing Remote Registries by Using System Policy Editor](#)
- [Accessing Remote Registries by Using Registry Editor](#)
- [Viewing a Remote Computer by Using System Monitor](#)
- [Using Net Watcher for Remote Administration](#)
- [Using Network Neighborhood for Remote Administration](#)
- [Using Network Backup Agents](#)
 - [Setting Up Network-Based Backup with the Arcada Agent](#)
 - [Setting Up Network-Based Backup with the Cheyenne Agent](#)
- [Preparing for Microsoft Network Monitor](#)
 - [Installing the Network Monitor Agent and Driver](#)
 - [Running Network Monitor Agent](#)
 - [Configuring Network Monitor Driver](#)
- [Using Remote Administration Tools from Other Vendors](#)
- [Removing Remote Agents and Services](#)

Remote Administration: The Basics

The remote management tools provided with Windows 95 are designed to make it easier for you to identify and solve problems encountered by users without dispatching support personnel to make changes at the users' work site. The following list describes the benefits of using these remote administration tools.

System Policy Editor.

You can use System Policy Editor to edit Registry entries in real time for remote computers. You can also create, edit, and manage system policies to control system settings for multiple computers on the network. For information, see [User Profiles and System Policies](#).

Registry Editor.

You can use Registry Editor to read and write values directly in the Registry. You can read settings, create new keys and entries, or delete existing keys. Registry Editor should be used only by those who have appropriate access rights to identify and correct problems.

System Monitor.

You can use System Monitor to troubleshoot performance problems by monitoring virtual device drivers across the network. System Monitor can provide you with performance information from many system components, including the file system and network clients.

Net Watcher.

If you use File and Printer Sharing services, you can use Net Watcher to create, add, and delete shared resources on remote computers, and to monitor and manage connections to shared resources. This is especially useful when you need to know who is connected to a computer and which files are open.

You can manage file systems remotely by browsing specific computers in Network Neighborhood, as described in [Using Network Neighborhood for Remote Administration](#).

Windows 95 also provides agents for remote administration, including an agent for Microsoft Network Monitor and an SNMP agent for administration with Simple Network Management Protocol (SNMP) system management products, as described in [Using Remote Administration Tools from Other Vendors](#).

Remote Administration: The Issues

Before you use the remote administration features, you should understand the following aspects of your networking and administrative needs.

To take advantage of the remote administration capabilities of Windows 95, you should do the following:

- Enable remote administration and user-level security on every computer that you will administer remotely. If you want to administer a remote computer using Registry Editor, System Monitor, or System Policy Editor, then the Microsoft Remote Registry service must be installed on your computer and the remote computer. Notice, however, that although the remote computer requires user-level security, it does not also require File and Printer Sharing services.
Optionally, the SNMP agent or the Microsoft Network Monitor agent should be installed if required for your administrative tools. For information, see [Setting Up for Remote Administration](#).
- Run a common network protocol, such as the Microsoft versions of the IPX/SPX-compatible protocol, TCP/IP, or NetBEUI.
- Train help desk personnel on System Monitor if they will use it. They should understand what each measurement provided by System Monitor means and what course of action is required in response to these measurements. For information, see [Performance Tuning](#).
- Train help desk personnel on what problems can be identified and repaired by using System Policy Editor or Registry Editor.

Both Registry Editor and System Policy Editor allow you to access a remote computer's Registry. However, System Policy Editor allows you to access only a subset of keys, while Registry Editor allows you to access the entire Registry. As a result, Registry Editor requires significantly more training. Also, it's important to remember that some changes made to the Registry on a remote computer require the user to shut down and restart the computer, while other changes take effect immediately. As a rule, if you must restart the computer when changing a setting by using Control Panel or other tools, then you must restart it when changing that setting in the Registry directly.

You can enable remote administration capabilities on a computer as part of the process for installing Windows 95 from custom scripts. For more information, see [MSBATCH.INF Parameters](#).

Setting Up for Remote Administration

This section provides details about how to set up remote administration after Windows 95 is installed.

The following table describes what you need to set up on the remote computer to complete an administrative task.

Remote administration task	Requirement on the remote computer
Browse and manage shared resources on a remote computer by using Net Watcher	Enable user-level security, remote administration, and File and Printer Sharing services; grant remote administration privilege to the network administrator
Manage the file system of a remote computer by using Net Watcher	Enable user-level security and remote administration; grant remote administration privilege to the network administrator
Edit a remote computer's Registry by using Registry Editor or System Policy Editor	Enable user-level security and remote administration, and install Microsoft Remote Registry services
Monitor performance of a remote computer by using System Monitor	Enable user-level security and remote administration, and install Microsoft Remote Registry services

Granting remote administration privilege gives that person full access to all shared resources on the system (including the ability to add and remove other remote administrators). Granting or removing access to remote administration capabilities for a user does not take effect until the next time the user connects to the computer running Windows 95.

When remote administration is enabled on a computer, two special shared directories are created:

- ADMIN\$ gives administrators access to the file system on the remote computer.
- IPC\$ provides an interprocess communication (IPC) channel between the two computers.

Important If you enable user-level security by using the Network option in Control Panel or in a setup script, remote administration is enabled automatically for the Domain Administrator group on a Windows NT domain. On a Novell® NetWare® network, the Supervisor account (for version 3.x) or the Admin account (for version 4.0) is enabled automatically. For more information, see [Security](#).

If you want to enable user-level security without automatically enabling remote administration, you can use system policies to enable the User-Level Access Control option. In this case, you must enable remote administration manually by using the Password option in Control Panel on each individual computer.



To enable remote administration manually

1. In the Passwords option in Control Panel, click the Remote Administration tab.
2. Make sure Enable Remote Administration Of This Server is checked.
3. If the computer is configured for share-level access control, specify the password for remote administration.

This dialog box is available only when share-level security is enabled.

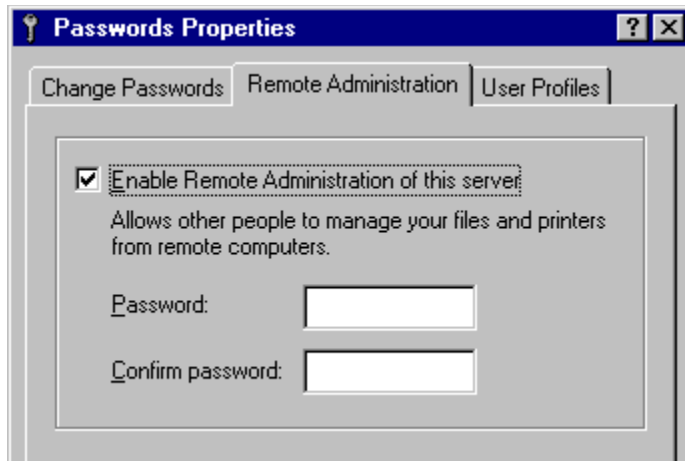

If the computer is configured for user-level access control, click the Add button, and add the appropriate administrators. Click OK.

This dialog box is available only when user-level security is enabled.

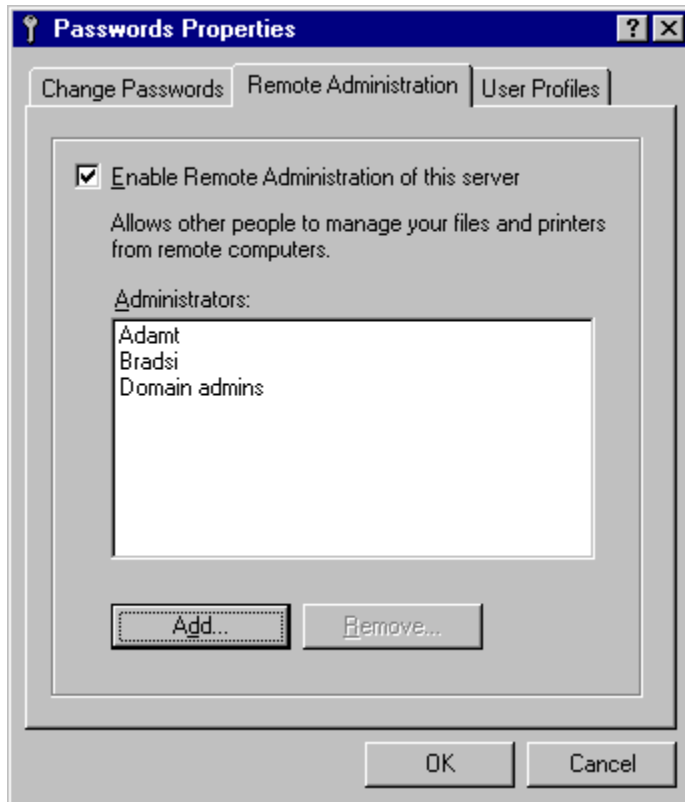

To install Microsoft Remote Registry services

1. In the Network option in Control Panel, click Add.
2. In the Select Network Component Type dialog box, double-click Service.
3. In the Select Network Service dialog box, click the Have Disk button.
4. In the Install From Disk dialog box, type the path to the ADMIN\NETTOOLS\REMOTREG directory on the Windows 95 compact disc, and then click OK.
5. In the Install From Disk dialog box, click OK.

6. In the Select Network Service dialog box, click Microsoft Remote Registry, and then click OK.

If you are prompted to specify the location of additional files, specify the path to the Windows 95 source files on a shared network directory or on the Windows 95 compact disc.

For information about installing the Microsoft Remote Registry service and enabling remote administration by using setup scripts, see [MSBATCH.INF Parameters](#).

Technical Notes on the Microsoft Remote Registry Service

- You must also install the Remote Registry service on the administrator's computer to ensure that the WINREG.DLL file is in the Windows SYSTEM directory on that computer.
- Make sure that both the administrator's and user's computers have at least one protocol in common. That can be either Microsoft NetBEUI, Microsoft TCP/IP, or the IPX/SPX-compatible protocol (with or without NetBIOS).

Remote Administration

Accessing Remote Registries by Using System Policy Editor

When you run System Policy Editor in Registry mode, you have direct access to the Registry for a local or remote computer. This section discusses how to access the Registry on a remote computer by using System Policy Editor. For information about installing and using System Policy Editor, see [User Profiles and System Policies](#).

As with Registry Editor, most of the changes you make with System Policy Editor in Registry mode modify the remote Registry as soon as you save the changes. These Registry changes apply to the user or to the computer. Some of these changes require the user to log off and then log back on.



To edit a remote computer's Registry by using System Policy Editor

1. In System Policy Editor, click the File menu, and then click Connect.
2. In the Connect dialog box, type the name of the computer you want to remotely administer, using the computer name for that computer as it appears in the Network option in Control Panel. Windows 95 connects to the Registry on the computer specified (assuming you have appropriate permissions).

The title bar of System Policy Editor shows whether you are viewing a local or a remote Registry.

3. Make changes by using the methods described in [User Profiles and System Policies](#).

After you have made a connection to the remote computer, you can use System Policy Editor for modifying user and computer properties just as you would on a local computer.

Accessing Remote Registries by Using Registry Editor

To solve a problem on a remote computer running Windows 95, you might need to access the entire Registry for the computer. In this case, you should use Registry Editor because System Policy Editor allows access to only a subset of Registry settings.

Note To use Registry Editor to edit the Registry on a remote computer, the Microsoft Remote Registry service must be installed on the remote computer, as described in [Setting Up for Remote Administration](#).



To edit the Registry on a remote computer by using Registry Editor

1. In Registry Editor, click the Registry menu, and then click Connect Network Registry.
2. In the Connect Network Registry dialog box, type the name of the computer you want to remotely administer.

Windows 95 adds the contents of the remote Registry below the contents of the local Registry.

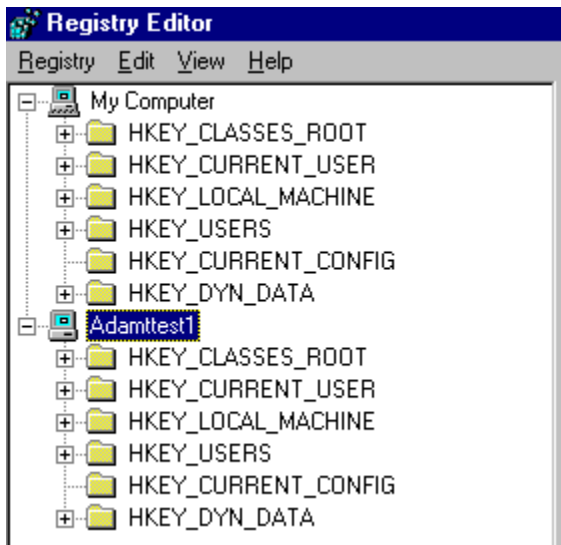

3. Make changes by using the methods described in [Windows 95 Registry](#).

Viewing a Remote Computer by Using System Monitor

System Monitor is a tracking tool that monitors the real-time performance of various computer components, functions, and behaviors and displays the results in graphs or charts. This information is useful in locating bottlenecks and solving other performance problems.

With the appropriate administrative privileges, you can use System Monitor over the network to track the performance of remote computers. To monitor more than one computer simultaneously, you can start multiple instances of System Monitor and connect to the appropriate computers.

For more information about installing and using System Monitor, see [Performance Tuning](#).

Note To use System Monitor to connect to a remote computer, the Microsoft Remote Registry service must be installed on the remote computer.



To view performance data on a remote computer by using System Monitor

1. In System Monitor, click the File menu, and then click Connect.
2. Type the name of the computer, and click OK.

Using Net Watcher for Remote Administration

Net Watcher is a Windows 95 tool for creating, controlling, and monitoring remote shared resources. This is a useful way to manage peer sharing services in Windows 95.

Note If you are not using File and Printer Sharing services, you can skip this section.

Net Watcher includes a set of icons that make it easy to do the following:

- Add a shared resource or stop sharing a resource
- Show all shared resources, connected users, and open files
- Close files users have opened
- Disconnect a user



To connect to a remote computer by using Net Watcher

1. From the Start button, click Run, and then type **netwatch**
2. From the Administer menu, click Select Server, and then type the name of the computer you want to connect to.
3. Type the password for remote administration on the computer you are connecting to.

The password depends on the type of security used on the remote computer:

- For share-level security, the password is the Remote Administration password specified in the Passwords option in Control Panel.
- For user-level security, the password is the one for an Administrator account specified in the Passwords option in Control Panel.

When using Net Watcher to view a remote computer, you should understand the following constraints:

- The remote computer must be running File and Printer Sharing services.
- If your computer uses share-level security, you can use Net Watcher to connect only to other computers that use share-level security. However, if the computer uses user-level security, you can use Net Watcher to connect to any other remote computers running File and Printer Sharing services. The pass-through server or domain does not have to be the same for the two computers.
- For computers running File and Printer Sharing for NetWare Networks, you can use Net Watcher to connect only to other computers running File and Printer Sharing for NetWare Networks. The pass-through server does not have to be the same for the two computers.
- On a NetWare network, you cannot use Net Watcher to close documents on remote computers. You can, however, use Net Watcher to disconnect users.

Tip You can prevent a user from sharing files although the user must have File and Printer Sharing services running to allow remote administration. To do this, set the system policies named Disable File Sharing Controls and Disable Print Sharing Controls. Disabling these options by using system policies does not remove the File and Printer Sharing services, while using the Network option in Control Panel does disable the service.

The following examples show how to create a shared resource on a remote computer by using Net Watcher.



To share a resource on a remote computer by using Net Watcher

1. To connect to a remote computer, follow the procedure named "To connect to a remote computer by using Net Watcher" earlier in this section.
2. Click the View menu, and then click By Shared Folders.
3. Click the Administer menu, and then Click Add Shared Folder.
4. In the Enter Path dialog box, type the drive and complete path of the resource that you want to share, and then click OK.

This example shows the shared directories on a remote computer running File and Printer Sharing for Microsoft Networks.

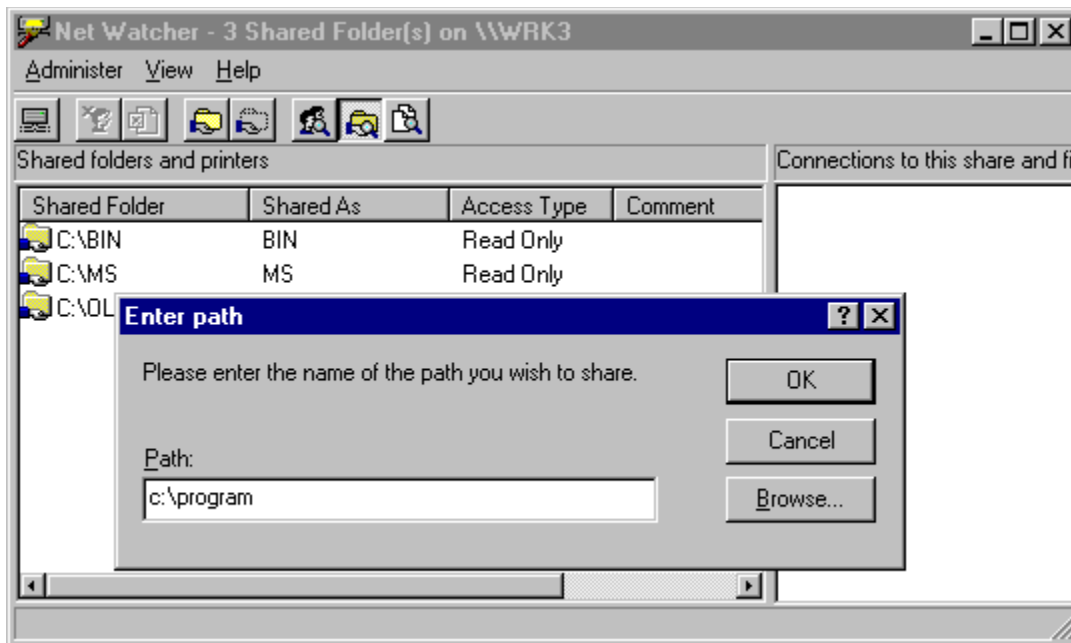

Using Network Neighborhood for Remote Administration

Another way to use System Policy Editor, Registry Editor, Net Watcher, or System Monitor remotely is to right-click the remote computer from within Network Neighborhood.



To manage remote computers in the local workgroup by using Network Neighborhood

1. In Network Neighborhood, right-click the icon of the computer you want to administer, and then click Properties.
2. In the computer's Properties dialog box, click the Tools tab.

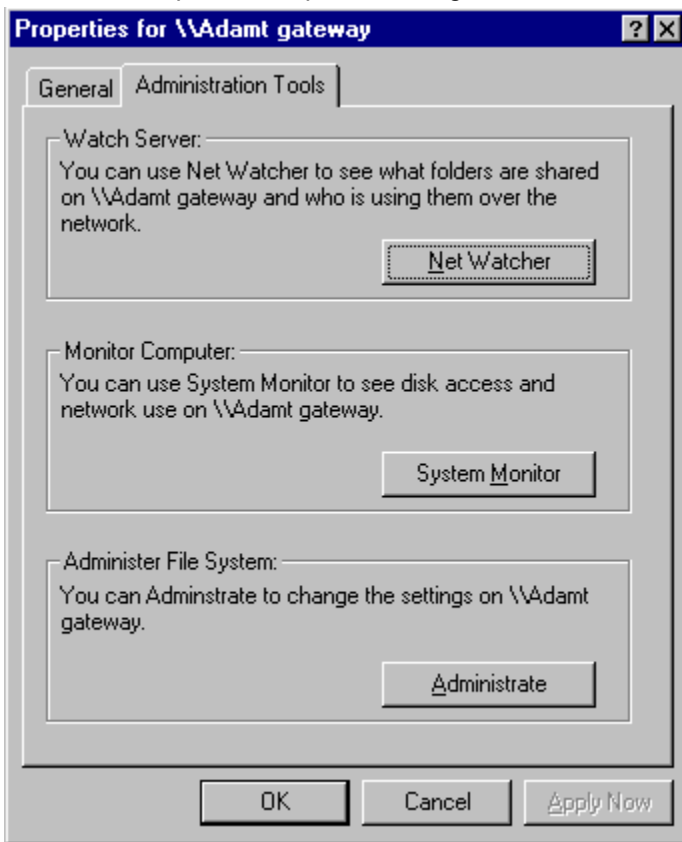

3. Click the button for the remote management task you want to perform, as described in the following list.

Option	Description
Net Watcher	Runs the Net Watcher tool and automatically connects to the specified computer.
System Monitor	Runs the System Monitor tool and automatically connects to the specified computer.
Administrate	Opens a folder on the desktop for the specified remote computer and allows you to access to the remote computer's hard disk drive.

Using Network Backup Agents

You can back up user data remotely by using either of the two network-based backup agents included with Windows 95. The Arcada® Backup Exec Agent and Cheyenne® ARCserve Agent allow you to

back up computers to a tape drive on a network server. You must have the corresponding server-based network backup software from either Arcada or Cheyenne.

The following sections describe how to install these backup agents on an individual computer, with a summary of the steps for running network-based backup when the agent is installed.

Setting Up Network-Based Backup with the Arcada Agent

To use the Arcada agent, you must have the following components:

- Arcada Backup Exec Agent (included with Windows 95). The agent includes the following files: BKUPAGNT.EXE, BKUPNET.DLL, and BKUPPROP.DLL.
- Arcada Backup Exec for NetWare, Enterprise Edition or Single Server Edition, version 5.01. To obtain this software, please contact Arcada directly at (800) 327-2232.

To back up a computer running Windows 95 with the Arcada agent, you must first install and enable the Arcada agent. If you didn't already do this during Setup, you can install and enable the Arcada agent by using the Network option in Control Panel. After you install the backup agent, the computer will run the agent automatically in the background when you start Windows 95.



To install and enable the Arcada Backup Exec Agent

1. In the Network option in Control Panel, click Add.
2. In the Select Network Component Type dialog box, double-click Service.
3. In the Select Network Service dialog box, click Arcada Software in the Manufacturers list, click Backup Exec Agent in the Network Services list, and then click OK.

To run Arcada network-based backup on a computer running Windows 95, run Arcada Backup Exec Agent (NetWare Enterprise Edition or Single Server Edition). See the product documentation for more information and instructions.

For information about installing the Arcada Backup Exec Agent by using custom setup scripts, see [Custom, Automated, and Push Installations](#).



To configure the Arcada Backup Exec Agent

1. In the Network option in Control Panel, double-click Backup Exec Agent in the list of network components.
2. Click the General tab, and then click Enable Network Backup.
3. If you want to specify a password to allow backup, make sure Password is checked, and then type the password.
4. If you do not want Registry files to be restored when other files are restored, make sure Allow Registry To Be Restored is not checked.
5. In the Published Folder area, use the Add and Remove buttons to define the list of folders and drives to be backed up.
6. If you want to define access control for selected folders based on password or real-only access, click the Details button.
7. Click the Protocol tab, and then click an option to specify the protocol that Backup Exec Agent should use (SPX/IPX or TCP/IP). For TCP/IP, you must also specify either the host name or IP address for the backup server.

For more information about configuring and using this agent, refer to the documentation provided with your Arcada Backup Exec software.

Setting Up Network-Based Backup with the Cheyenne Agent

To use the Cheyenne agent, you must have the following components:

- Cheyenne ARCserve Agent (included with Windows 95). The agent includes the following files: ARCSRV32.EXE and CHEYPROP.DLL.
- Cheyenne ARCserve for NetWare (version 5.01).
- New versions of Cheyenne network loadable modules (NLMs), which have been updated specifically for Windows 95. These include the APROCESS.NLM, ARCOPY.NLM, and WSTAPE.NLM files. To obtain these files, contact Cheyenne directly at (800) 243-9832.

To back up a computer running Windows 95 with the Cheyenne agent, you must first install and enable the Cheyenne agent. If you did not already do this during Setup, you can install and enable the Cheyenne agent by using the Network option in Control Panel. After you install the backup agent, the computer will run the agent automatically in the background when you start Windows 95.



To install and enable the Cheyenne ARCserve Agent

1. In the Network option in Control Panel, click Add.
2. In the Select Network Component Type dialog box, double-click Service.
3. In the Select Network Service dialog box, click Cheyenne Software in the Manufacturers list, click ARCserve Agent in the Network Services list, and then click OK.

To run Cheyenne network-based backup on a computer running Windows 95, run Cheyenne ARCserve for NetWare. See the product documentation for more information and instructions.

For information about installing the Cheyenne ARCserve Agent by using custom setup scripts, see [Custom, Automated, and Push Installations](#).



To configure the ARCserve agent

1. In the Network option in Control Panel, double-click ARCserve Agent in the list of network components.
2. Click Enable Network Backup.
3. If you want to specify a password to allow backup, type the password in the Password box, and then type it again in the Confirm Password box.
4. If you do not want Registry to be restored when other files are restored, make sure Do Not Restore Registry is checked.
5. Use the Add and Remove buttons to define the list of folders and drives that should not be backed up.

For more information about configuring and using this agent, see the documentation provided with your Cheyenne ARCserve software.

Preparing for Microsoft Network Monitor

The Windows 95 compact disc includes a protocol driver and agent for Microsoft Network Monitor. The protocol driver provides performance counters that can be viewed by using System Monitor if you want to assess certain network traffic statistics for NDIS 3.1 protected-mode network adapters. The Network Monitor agent, which runs as a Windows 95 service, works with the protocol driver for use with the Microsoft Network Monitor application. You can use this application to detect and troubleshoot problems on LANs, WANs, and Microsoft Remote Access Service (RAS) connections.

Note The Network Monitor application is provided with Microsoft Systems Management Server, which is a client-server system that allows administrators to perform key management functions for distributed computers from a central location. For more information, see [Microsoft Systems Management Server](#).

Installing the Network Monitor Agent and Driver

When you install the Network Monitor agent, the protocol driver is also installed automatically. You must have both the agent and the driver installed if you want to use the agent with Network Monitor to conduct remote captures of network traffic to and from a computer running Windows 95.

However, if you want only to view the performance counters in System Monitor and you want to prevent anyone from accessing the local computer by way of the Network Monitor agent, you can choose to install only the protocol driver.

Note The Network Monitor application uses NetBIOS to control the remote-capture computer. If you are using the IPX/SPX-compatible protocol to connect the agent and manager computers, you must enable NetBIOS support for IPX/SPX, as described in [Network Technical Discussion](#).



To install the Network Monitor agent on a single computer

1. In the Network option in Control Panel, click Add.
2. In the Select Network Component Type dialog box, double-click Service.
3. In the Select Network Service dialog box, click the Have Disk button.
4. In the Install From Disk dialog box, type the path to the ADMIN\NETTOOLS\NETMON directory on the Windows 95 compact disc, and then click OK.
5. In the Select Network Service dialog box, click Microsoft Network Monitor Agent in the Models list, and then click OK.



To install only the Microsoft Network Monitor protocol driver

1. In the Network option in Control Panel, click Add.
2. In the Select Network Component Type dialog box, double-click Protocol.
3. In the Select Network Protocol dialog box, click the Have Disk button.
4. In the Install From Disk dialog box, type the path to the ADMIN\NETTOOLS\NETMON directory on the Windows 95 compact disc, and then click OK.
5. In the Select Network Protocol dialog box, click Microsoft Network Monitor Driver in the Models list, and then click OK.

For information about installing the Microsoft Network Monitor agent and protocol driver by using custom setup scripts, see [Custom, Automated, and Push Installations](#). For information about using Network Monitor for performance analysis, see [Performance Tuning](#); for information about using Network Monitor for network protocol analysis, see [Microsoft Systems Management Server](#).

Remote Administration

Preparing for Microsoft Network Monitor

Running Network Monitor Agent

You can run the Network Monitor agent as a service, or you can start and stop the agent as an executable application.



To start Microsoft Network Monitor agent

- Click the Start button, click Run, and then type **nmagent**

The Network Monitor agent is removed from the system each time you log off, and must be restarted for each user that logs on if the agent is not scheduled to run as a service.



To run Network Monitor agent as a service

1. In Registry Editor, select the following Registry key:

```
Hkey_Local_Machine\Software\Microsoft\Windows\CurrentVersion  
  \RunServicesOnce
```

2. Click the Edit menu, point to New, and then click String Value.
3. Type a label for the value name, such as **nm agent**, and then press ENTER.
4. Click the Edit menu, and then click Modify.
5. In the Value Data box, type:
nmagent.exe
6. Click OK.

The Network Monitor agent will continue to run after a user logs off if it is started as a service. You can, however, type a command to stop running the agent, whether the agent was started as a service or run from the command prompt.



To stop the Network Monitor agent

- Click the Start button, click Run, and then type **nmagent -close**

Configuring Network Monitor Driver

You can configure options for Network Monitor by defining properties for the Network Monitor protocol driver. For information about using the Network Monitor driver to display system performance statistics, see [Performance Tuning](#).



To configure the Microsoft Network Monitor protocol driver

1. Make sure that the Network Monitor agent is not running and that System Monitor is not monitoring the performance statistics provided by the Network Monitor driver.
2. In the Network option in Control Panel, double-click Microsoft Network Monitor Driver.
3. In the Microsoft Network Monitor Driver Properties dialog box, click the Password tab. You can define the password that users must specify to capture data, view capture files, or access the computer remotely. The following options are available:
 - If you want to change any password that has been previously defined, type a password in the Old Capture Password area.
 - If you want to define a password to restrict users to viewing only previously saved capture files by using the Network Monitor application, type a password in the Display Password area.
 - If you want to define a password to authorize users to connect to the computer and capture files by using the Microsoft Network Monitor application, type a password in the Capture Password area. You can define only one password for all network adapters on a computer with multiple adapters.
 - If you want to allow free access to the computer by anyone running the Network Monitor application, then make sure No Password is checked.
4. If the computer has more than one network adapter, click the Describe tab, and then click the network adapter you want to monitor.

You can also define a description for each network adapter in this dialog box, so that administrator running the Network Monitor application can determine which adapter to select.
5. Click the Advanced tab. In the Value box, type the user name that will be shown when an administrator running the Network Monitor application selects the Identify Network Monitor Users command.

This additional information, which is similar to a comment, does not get updated or changed if another user logs on to this computer.

Note The settings on the Bindings tab have no effect.

Using Remote Administration Tools from Other Vendors

You can also remotely administer computers running Windows 95 by using other system management tools provided by Microsoft or by other vendors. The following list shows some of the system management tools that you can use to manage computers running Windows 95:

- Microsoft Systems Management Server
- Microsoft Windows NT Server
- Novell NMS
- HP® Open View for Windows
- Intel® LANDesk™
- IBM® LAN NetView®
- Sun® NetManager

For networks that use SNMP for system management, Windows 95 includes an SNMP agent which conforms to the SNMP version 1 specification. This agent allows you to monitor, from an SNMP console, remote connections to computers running Windows 95. After this agent is installed, you do not need to make any other modifications to client computers to use SNMP.

The SNMP agent is implemented as a Win32-based service and works using Windows Sockets over both TCP/IP and IPX/SPX. The extension agents are implemented as Win32 DLLs. (For more information about writing SNMP MIBs under Windows 95, see the *Microsoft Win32 Software Development Kit*.)

The configuration information for the RFC 1156 extension agent is placed in the Registry under the following key:

```
Hkey_Local_Machine\System\CurrentControlSet\Services\SNMP\Parameters
```



To install the Microsoft SNMP agent

1. In the Network option in Control Panel, click Add.
2. In the Select Network Component Type dialog box, double-click Service.
3. In the Select Network Service dialog box, click the Have Disk button.
4. In the Install From Disk dialog box, type the path to the ADMIN\NETTOOLS\SNMP directory on the Windows 95 compact disc, and then click OK.
5. In the Select Network Service dialog box, click Microsoft SNMP Agent in the Models list, and then click OK.

If you are prompted to specify the location of additional files, specify the path to the Windows 95 source files on a shared network directory or on the Windows 95 compact disc.

For information about installing the Microsoft SNMP agent by using custom setup scripts, see [Custom, Automated, and Push Installations](#).

When the computer is restarted after the SNMP agent is installed, SNMP automatically starts in an MS-DOS window. You can minimize this window to keep it out of the way while working.



To configure the SNMP agent

- Use System Policy Editor to set the following policies for the computer:

Policy	Description
Communities	Specifies one or more groups of hosts to which this computer belongs for purposes of administration using the SNMP service. These are the communities that are allowed to query the SNMP agent.
Permitted Managers	Specifies IP or IPX addresses allowed to obtain information from an SNMP agent. If this policy is

not checked, any SNMP console can query the agent.

Traps for Public Community

Specifies *trap destinations*, or IP or IPX addresses of hosts in the public community to which you want the SNMP service to send traps.

Internet MIB (RFC 1156) Allows you to specify the contact name and location if you are using Internet MIB.

If you want to configure the Windows 95 SNMP agent to send traps to a community other than the public community, you must either edit the Registry directly or add a new system policy.



To add SNMP communities by editing the Registry

1. In Registry Editor, select the following key:

```
Hkey_Local_Machine\System\CurrentControlSet\Services  
\SNMP\Parameters\TrapConfiguration
```

2. Click the Edit menu, point to New, and then click Key.

3. Type the name that you want to specify for a new community, and press ENTER.

4. Create a new string value for each console to which the SNMP should send traps:

- The first value name should be 1, the second value name should be 2, and so on.
- The value data must be the IP or IPX address of the SNMP console to which traps will be sent.

To create a string value, click the new key, click the Edit menu, point to New, and then click New String. Type the value name, and then press ENTER.

To specify the value data, click the value name, click the Edit menu, and then click Modify. In the Value Data box, type the value data, and then click OK.

The following illustration shows an example of what the Registry should look like after adding a new community named Prv1.

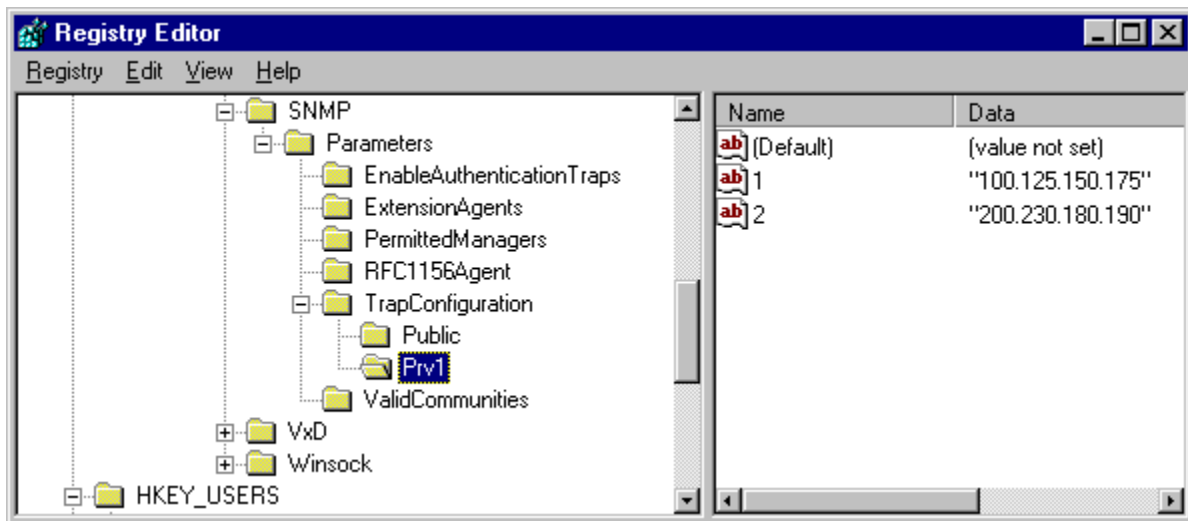

To add SNMP communities by using system policies

1. Start a text editor, and open the ADMIN.ADM file in the INF subdirectory of the Windows directory.

2. Add an entry in the section named CATEGORY !!SNMP, specifying the following new values:

- *Name Of New Policy*, which defines the text that you want to appear in System Policy Editor for this policy. You do not need to include "!!" if you use quotation marks around the name. The "!!" string is used only for Windows 95 localization, and the strings are defined at the bottom of ADMIN.ADM.

- *Name Of New Community*, which defines the name of the community for which you are adding support.

The following shows the complete syntax for this entry:

```
POLICY "Name Of New Policy"
  KEYNAME
  System\CurrentControlSet\Services\SNMP\Parameters
    \TrapConfiguration\Name Of New Community
  PART !!Traps_PublicListbox LISTBOX
    VALUEPREFIX ""
  END PART
END POLICY
```

Note The Registry key and value names are case-sensitive. Also, the Registry key name (System\...\i>Name Of New Community) must be one continuous line in the ADMIN.ADM file.

For example, the following adds a policy for a community named Prv1:

```
POLICY "Traps for Prv1 Community"
  KEYNAME
  System\CurrentControlSet\Services\SNMP\Parameters\TrapConfiguration\Prv1
  PART !!Traps_PublicListbox LISTBOX
    VALUEPREFIX ""
  END PART
END POLICY
```

After editing and saving ADMIN.ADM, you can see this new policy by running System Policy Editor and selecting the Computer policy under Network named SNMP. You can use this policy exactly as you would use the policy named Traps For Public Community.

Removing Remote Agents and Services

Any agent that runs as a network service and that appears in the Network option in Control Panel can be removed by selecting it and clicking the Remove button.

You can use System Policy Editor to turn off services by setting system policies, or by using Registry mode to modify a computer's Registry. To do this, in the computer properties, click System. Then delete the services that you no longer want under the Run and Run Services policies.

Some agents, such as the SNMP agent, can be removed only by modifying the Registry. For a single computer, you can do this by using either Registry Editor or System Policy Editor. The following Registry keys list the services running on the computer:

```
Hkey_Local_Machine\Software\Microsoft\Windows\CurrentVersion\RunServices  
Hkey_Local_Machine\Software\Microsoft\Windows\CurrentVersion\Run
```

Introduction

Windows 95 provides the easiest methods and best defaults ever offered for configuring system memory and ensuring good performance on an x86-based computer. This chapter summarizes system features related to performance and describes tools for monitoring and managing system performance.

- [Windows 95 Performance Tuning: The Basics](#)
- [Windows 95 Performance Tuning: The Issues](#)
- [System Performance Overview](#)
 - [System Resource Capacity in Windows 95](#)
 - [Technical Notes on MS-DOS Components in Windows 95](#)
- [Optimizing the Swap File](#)
- [Optimizing File System Performance](#)
 - [Optimizing File System Performance with Profiles](#)
 - [Optimizing CD-ROM File System Performance](#)
 - [Using File-System Troubleshooting Options](#)
- [Setting Graphics Compatibility Options](#)
- [Optimizing Printing](#)
- [Optimizing Network Performance](#)
- [Optimizing Conventional Memory](#)
- [Tracking Performance with System Monitor](#)
 - [Configuring Performance Charts in System Monitor](#)
 - [Identifying Performance Problems with System Monitor](#)
 - [Summary of System Monitor Categories](#)

Windows 95 Performance Tuning: The Basics

The Windows 95 architecture includes several improvements over earlier versions of Windows. These changes, which strongly impact most areas of system performance, include the following:

- Fully integrated 32-bit, protected-mode operating system, eliminating the need to run MS-DOS separately
- Complete 32-bit kernel, providing improved memory management and process scheduling, plus improved system-wide robustness and improved cleanup after an application closes or fails, delivering a more stable and reliable operating environment
- Preemptive multitasking and multithreading support, providing improved system responsiveness, smooth background processing, and improved system capacity, allowing multiple applications and system tasks to run well concurrently
- 32-bit installable file systems to support better performance and long filenames
- 32-bit device drivers for all system components, ensuring better performance and better resource management

Many Windows 95 features provide dynamic configuration, reducing or eliminating the need for users to adjust their system settings. The following self-tuning features in Windows 95 are designed to improve performance and reduce support costs.

Dynamic swap file and dynamic caching using VCACHE.

Windows 95 uses dynamic sizes for the virtual-memory swap file, the cache for file and network access, and the CD-ROM cache. Both the swap file and cache sizes can grow or shrink, depending on the computer's memory configuration and the demand for memory from applications. This relieves users or administrators from having to change the cache parameters as new memory or new applications are added. Windows 95 can take advantage of new memory automatically and expand or reduce the file and cache sizes automatically based on demands when applications are loaded or unloaded. Also, the networking, disk, CD-ROM, and paging caches are integrated and will scale as more memory is added to the computer. For more information, see [Optimizing the Swap File](#) and [Optimizing File System Performance](#).

32-bit disk and file access for fast hard-disk access.

These mechanisms allow Windows 95 to access the hard disk or file system directly, bypassing the computer's BIOS. Using 32-bit file and disk access improves performance and allows Windows 95 to handle BIOS requests in protected mode, rather than in real mode. For more information, see [Disks and File Systems](#).

Background print rendering.

For a computer that has sufficient memory to take advantage of it, background print rendering is available automatically to reduce the return-to-application time for printing. With this feature, Windows 95 first writes an enhanced metafile (EMF) format file, which is a device-independent rendering of the print job that is much faster to produce than a device-specific rendering. In the background, Windows 95 uses the EMF file to create the device-dependent rendering while the user continues to work in the application. For more information, see [Optimizing Printing](#).

Automatic system adjustments during Windows 95 Setup.

During installation, Windows 95 Setup makes decisions about certain operating system features based on the hardware configuration. For example, in a computer with low memory, Windows 95 turns off background print rendering, because this feature increases the operating system working set that is loaded into memory and cannot be paged out to the swap file.

Built-in tools for monitoring and adjusting system performance.

The following tools in Windows 95 are available for managing performance-related settings:

- System option in Control Panel provides settings for tuning and troubleshooting. For information, see [Optimizing the Swap File](#), [Optimizing File System Performance](#), and [Setting Graphics Compatibility Options](#).
- System Monitor can be used to track the performance of key system components, as described in [Tracking Performance with System Monitor](#).

- DriveSpace includes a protected-mode driver that is installed by default, providing faster performance than the earlier real-mode compression driver and using only an additional 10 or 15 percent overhead. If you are using any real-mode disk-compression utilities other than DriveSpace or DoubleSpace, plan to switch to a protected-mode version. Contact the manufacturer to determine availability of protected-mode drivers that are compatible with Windows 95.
- Disk Defragmenter can improve file access time by defragmenting uncompressed FAT drives and compressed DriveSpace or DoubleSpace drives. Fragmentation occurs over time, as programs read from and write to the hard disk. Eventually, files must be stored in noncontiguous sectors on a disk. Fragmentation doesn't affect the validity of the information, but it takes much longer for the computer to read and write fragmented files.

For more information about DriveSpace and Disk Defragmenter, see [Disks and File Systems](#).

Windows 95 Performance Tuning: The Issues

This section summarizes performance issues, which are related principally to computer hardware.

486 versus 386 processors.

Windows 95 uses more 32-bit code than Windows 3.1, so it benefits more than Windows 3.1 did from a 486-based processor. This is because the 486-class chip is better optimized for 32-bit code than the 386-class chip. For a given clock rate, if you run a 16-bit performance benchmark on a 386-based versus a 486-based computer, the 486-based computer will outperform the other computer. If you run the same benchmark using 32-bit code, the 486-based computer will outperform the 386-based computer by an even greater margin. Overall, Windows 95 provides significant performance improvements on a 486-based (or higher) processor.

DX versus SX processors.

Although the minimum requirement to run Windows 95 is a 386SX-based processor, the SX processor is not a full 32-bit CPU. The SX-based processor accesses memory using 32-bit addressing, but it accesses data in 16-bit increments. Although Windows 95 will run on an SX-based processor, you will most likely not be satisfied with the perceived performance when compared to a 16-bit operating system such as Windows 3.1.

Hard disk speed.

Hard disk speed affects Windows 95 more than Windows 3.1. To support many applications running at once, applications are paged out to the swap file when there is more demand for memory than what is available physically. This is a very efficient mechanism for running many applications in a constrained memory environment. Windows 95 performance can be enhanced greatly by installing a faster hard disk. Hard disk speed will also have a great effect on performance when running File and Printer Sharing services.

Processor and bus speed.

In Windows 95, processor and bus speed have a greater impact on display performance than under Windows 3.1. Display performance under Windows 3.1 was affected by inefficiencies in the monolithic display drivers and typically poor bus throughput (mostly ISA), so the CPU would typically encounter bottlenecks in either the bus or monolithic driver when writing to the display. With PCI and the miniport driver model under Windows 95, a CPU can send data as fast as possible down the PCI bus and through the miniport driver without encountering a bottleneck. This means that CPU performance can greatly affect display performance in Windows 95.

Miniport drivers for display adapters.

The new display drivers in Windows 95 have been optimized for enhanced display speed and improved graphics performance. Microsoft created a new universal driver with a better mechanism for manipulating memory bitmaps, which provides fast, reliable graphics support. Microsoft provides miniport drivers for most current display adapters, and these new drivers should be used whenever possible. Contact the hardware manufacturer to obtain new drivers if the correct driver is not provided with Windows 95.

Protected-mode drivers for increased performance and reliability.

Windows 95 provides protected-mode drivers for most devices, including display, network, disk, and so on. These drivers have been developed and tested to ensure better performance and increased reliability over real-mode drivers. After Windows 95 switches into protected mode during system startup, any time an I/O operation uses a device controlled by a real-mode driver, the computer has to switch from protected mode to virtual 8088 mode. This is a very expensive operation in terms of CPU cycles and typically has to be done several times during a single I/O operation, adversely impacting performance. Relying on a real-mode driver for I/O operations also reduces the degree of multitasking that Windows 95 can provide because real-mode drivers were not designed for a preemptively multitasking environment. Therefore, wherever possible, use protected-mode device drivers.

Added memory.

Unlike Windows 3.1, caching in Windows 95 is dynamic, which means that Windows 95 performs better than Windows 3.1 when you increase the amount of system memory. Also, under Windows 95 you do not have to reconfigure the operating system when you change the memory configuration; Windows 95 reconfigures itself automatically.

Low memory (4-MB) computers.

Most of the tuning necessary for a computer with low memory happens automatically, but to reduce the size of the Windows 95 working set and give the maximum amount of memory to applications, run only one network client; if possible, run a single network protocol; and run the fewest possible network services.

Extended Capabilities Port (ECP) for printers.

For locally attached printers, or for computers acting as print servers, it's helpful to use a computer that supports the ECP specification. This ensures better print throughput and bidirectional communications.

For information about performance related to network adapters, see [Optimizing Network Performance](#).

System Performance Overview

Windows 95 greatly reduces the system resource limitations that many users experienced with Windows 3.1. Windows 95 also cleans up resources that have not been freed to help reduce system resource limitations. When Windows 95 determines that an application that owned certain resources no longer needs those resources in memory, it deallocates remaining data structures, freeing the resources for use elsewhere in the system.

Wherever possible, Windows 95 is self-tuning, adjusting cache sizes or other elements of the system environment to provide the best performance for the current configuration. Windows 95 can also detect when the drivers loaded or other performance-related components are not providing the optimal performance.



To see a report of performance problems

- In the System option in Control Panel, click the Performance tab.

Windows 95 reports the current performance status, including whether 32-bit, protected-mode components are being used.

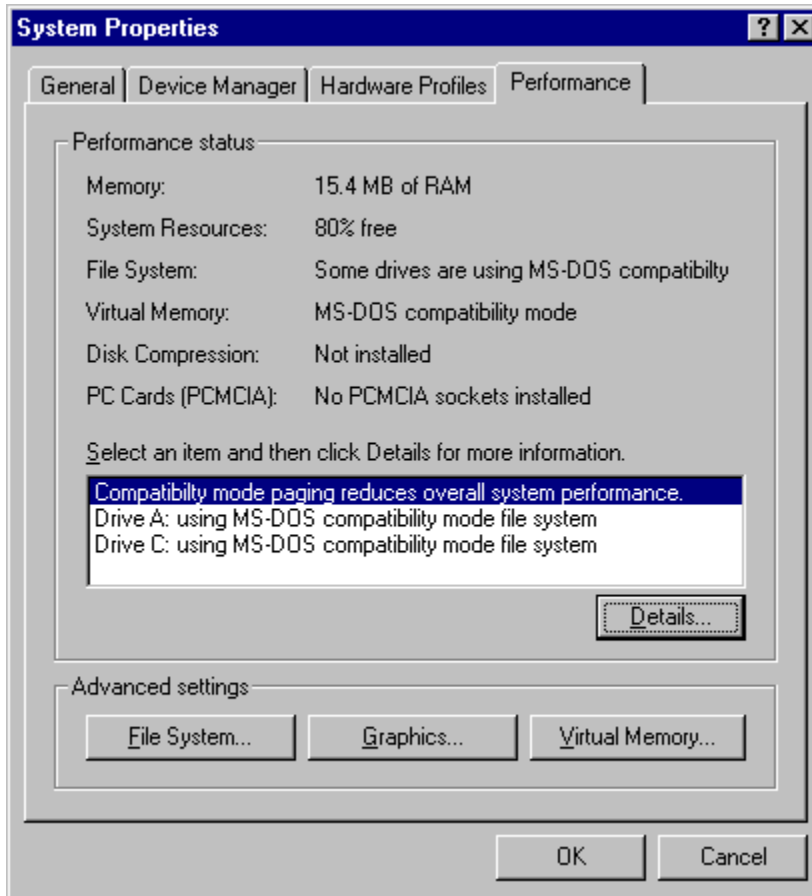

If the performance status shows that real-mode components are being used for any device — and especially for disk drivers — you need to solve all the problems that prevent protected-mode drivers from loading. For information, see [Devices](#). This chapter describes methods for optimizing or solving problems related to virtual memory, file system, or graphics performance.

System Resource Capacity in Windows 95

Windows 95 provides a significant increase in the system resources available to Windows-based and MS-DOS-based applications over what was available under earlier versions of Windows. The net result for users is that they can count on more system resources being available for creating windows, using fonts, running five or more applications simultaneously, and so on.

Windows 3.1 maintained 64K regions of memory *heaps* for use by the graphics device interface (GDI) and USER system components. These heaps stored GDI or memory object information allocated when an application called a Windows API function. The amount of space available in the combination of these two heaps is identified as a percentage of system resources that are free (that percentage appears in the Help About dialog box in My Computer and other Windows-based applications). Under Windows 3.1, when the calculated amount of free space dropped to a low number, the system often reported that it was out of memory even though the amount of free memory shown in the About dialog box was still quite high. This was often due to low memory in either the GDI or USER heap, or both.

In Windows 95, to help reduce the system resource limitation, many data structures formerly stored in the 16-bit GDI and USER heaps are now stored in 32-bit heaps. This provides more room for the remaining data elements to be created.

The following table shows the system limits in Windows 95, as compared to the constraining limits under Windows 3.1. For information about how to assess performance of key system resources, see [Identifying Performance Problems with System Monitor](#). For information about the supporting architecture, see [Windows 95 Architecture](#).

Windows 95 System Limits

Resource	Windows 3.1 ¹	Windows 95 ²
Windows Menu handles	~299	32K
Timers	32	Unlimited
COM and LPT ports	4 per type	Unlimited
Items per listbox	8K	32K
Data per listbox	64K	Unlimited
Data per edit control	64K	Unlimited
Regions	All in 64K segment	Unlimited
Physical pens and brushes	All in 64K segment	Unlimited
Logical pens and brushes	All in 64K segment	All in 64K segment
Logical fonts	All in 64K segment	750-800
Installed fonts	250-300 (best case)	1000
Device contexts	200 (best case)	16K

¹ Limits for GDI objects in Windows 3.1 are not exact because all regions, physical objects, logical objects, device contexts (DCs), and installed fonts had to fit in a single 64K segment. Because many of these have been moved to the 32-bit heap, Windows 95 provides much more room for those remaining items, such as logical pens, brushes, and so on. The remaining items in the Windows 95 local heap are all less than 10-20 bytes each.

² System-wide resources, unless noted otherwise.

Technical Notes on MS-DOS Components in Windows 95

Many users have wondered whether Windows 95 contains MS-DOS code, and if so, whether that means that Windows 95 is somehow built on top of MS-DOS. Many of these questions relate to how

Windows 95 achieves the highest possible degree of compatibility with existing devices and the myriad applications created for MS-DOS and Windows 3.x. Three key questions are answered here:

- How does Windows 95 support internal processes and certain application services?
- How does Windows 95 reclaim memory from real-mode drivers?
- Why does IO.SYS load WIN.COM rather than directly loading VMM32.VXD?

The following services are based on entirely new code created for Windows 95, not revisions to MS-DOS code:

- Process and thread memory management
- Interprocess communications and synchronization
- Preemptive Win32 subsystem
- CD-ROM, hard disk, and network I/O services
- High-level graphics operations and window management
- Printing services

Some functions, however, are handled by MS-DOS code, although the code itself is running in virtual 8086 mode, not real mode. Functions implemented in this manner ensure backwards compatibility with existing real-mode software, such as the Novell® NetWare® client. The following list shows such functions:

Create Program Segment Prefix (function 55h)	Get DOS Version (function 30h)
Create Temp File (function 5Ah)	International (function 65h)
Dup File Handle (function 45h)	Set/Get Drive (functions 0Eh and 19h)
Exit (function 4Ch)	Set/Get Program Segment Prefix (functions 50h and 51h)
Get Date/Time (functions 2Ah and 2Ch)	NetWare Get Station Num (function DCh)

An important example of how Windows 95 reclaims memory from real-mode device drivers is MSCDEX, the CD-ROM driver. After Windows 95 Setup is completed and Windows 95 starts from the hard disk for the first time, special code runs to determine whether the protected-mode CDFS drivers have taken over the CD-ROM drive completely. If so, the real-mode MSCDEX driver in memory is matched to the related lines in AUTOEXEC.BAT, and the MSCDEX entries are then commented out. This provides a trail in AUTOEXEC.BAT to show what has happened. Similar methods are used for other device drivers that Windows 95 knows to be safe to remove, such as other vendors' real-mode disk cache utilities and redundant protected-mode VxDs.

As a final example, some users have wondered whether the fact that IO.SYS loads WIN.COM (rather than loading VMM32.VXD directly) is an indication that Windows 95 is built on Windows 3.x code, with the addition of new virtual device drivers. However, IO.SYS is used to load WIN.COM only for purposes of backward compatibility. Certain real-mode drivers and TSRs insert themselves at various places in the Windows 3.1 startup process. If Windows 95 were to bypass the loading of WIN.COM and instead load virtual device drivers directly, any driver that needs to insert itself when WIN.COM is loaded would never be called. Instead, Windows 95 starts in precisely the same way as Windows 3.1 and loads the same components in the same order, ensuring compatibility with earlier versions of applications and device drivers.

Optimizing the Swap File

Windows 95 uses a special file on your hard disk called a virtual-memory swap file (or paging file). With virtual memory under Windows 95, some of the program code and other information are kept in RAM while other information is swapped temporarily to virtual memory. When that information is required again, Windows 95 pulls it back into RAM and, if necessary, swaps other information to virtual memory. This activity is invisible, although you might notice that your hard disk is working. The resulting benefit is that you can run more programs at one time than the computer's RAM would usually allow.

On Windows 3.x, users could enhance performance by changing virtual memory settings. The Windows 95 swap file is dynamic, so it can shrink or grow based on the operations performed on the system and based on available disk space. A dynamic swap file is usually the most efficient use of resources. The swap file can also occupy a fragmented region of the hard disk with no substantial performance penalty.

Tip for Swap File Performance

The single best way you can ensure high swap file performance is to make sure that the disk containing the swap file has ample free space so that the swap file size can shrink and grow as needed.

The Windows 95 swap file (WIN386.SWP) is not a permanent file. However, Windows 95 can also use a permanent Windows 3.1 swap file. In this case, the file cannot shrink below the permanent size set for it in Windows 3.1, although the file can grow bigger if required.

Under Windows 95, the swap file can reside on a compressed drive if a protected-mode driver (that is, DRVSPACE.VXD) controls the compressed drive. DriveSpace marks the swap file as uncompressible and, to reduce the risk of fragmentation, places the swap file as the last file in the sector heap, which allows room for the swap file to grow.

For a computer that runs a shared version of Windows 95 from a server, the swap file is placed in the computer's machine directory. If the computer is started from a floppy disk or uses remote booting, the swap file is in the machine directory on the network. If the computer is started from the local hard disk, the swap file can be stored in the machine directory on the local computer.

Although the system defaults usually provide the best performance, you can adjust the parameters used to define the swap file. For example, to optimize swap file performance on a computer with multiple hard disk drives, you might want to override the default location of the Windows 95 swap file. The swap file should be placed on the drive with the fastest performance (unless that disk is overused). If a user usually loads all software from the same drive in a computer that has multiple drives, performance might be boosted by placing the swap file on one of the drives that is not as busy.

Caution Completely disabling virtual memory might cause the computer to stop operating properly. You might not be able to restart the computer, or system performance might be degraded. Do not disable virtual memory unless instructed to do so by a technical support representative.



To adjust the virtual memory swap file

1. In the System option in Control Panel, click the Performance tab.
2. Click the Virtual Memory button.
3. To specify a different hard disk, click the option named Let Me Specify My Own Virtual Memory Settings. Then specify the new disk in the Hard Disk box. Or, type values (in kilobytes) in the Minimum or Maximum boxes. Then click OK.

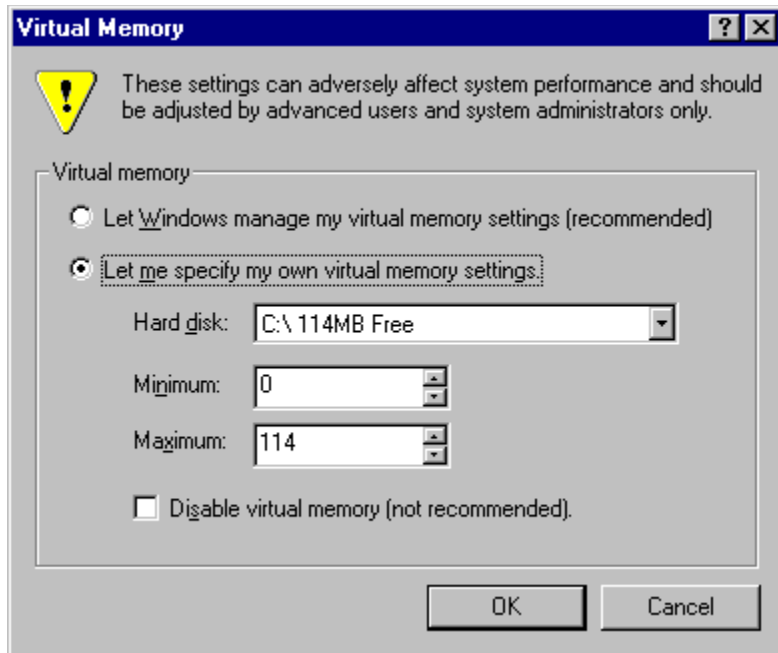

If you set the maximum swap file size in the Virtual Memory dialog box to the amount of free space currently on a drive, Windows 95 assumes that it can increase the swap file beyond that size if more free disk space becomes available. If you want to impose a fixed limit on the swap file size, make sure that the limit you choose is less than the current maximum.

Optimizing File System Performance

In Windows 95, the disk cache is dynamic. You do not need to configure its size as part of system configuration. Because of this, the following types of settings used for Windows 3.x are not required in Windows 95 and should be removed from the configuration files.

Configuration file Configuration setting to remove

autoexec.bat	SHARE SMARTDRV settings Any entries for other disk cache software ¹
config.sys	SMARTDRV settings (double-buffer driver) Any entries for other disk cache software

¹ For a list of the disk caching software that is removed by Windows 95 Setup, see [Setup Technical Discussion](#).

The overall performance, for example, of a computer with 8 MB of memory is better under Windows 95 than under Windows 3.1. However, the amount of paging might be more under Windows 95 for several reasons:

- Windows 95 aggressively writes the contents of dirty memory pages (pages that contain changes) during system idle time, even if it doesn't need the memory at that time. This causes more idle-time disk activity but speeds up future memory allocations by doing some of the work when the system is idle.
- Much more of Windows 95 can be paged out to disk than Windows 3.1. That's why it's even possible to still run applications on low-memory computers when Windows 95 requires a working set of 4 MB. However, the working set isn't the amount of memory you need to hold all code and data; it's just the amount of memory you need to avoid an unacceptable amount of paging.

Changing the cache size (even if you could) probably wouldn't have much effect on paging. Paging through the cache would quickly overwhelm it and make it useless for other file I/O. Although swap file I/O operations don't go through the cache, memory-mapped files and executable files do. The cache, however, is designed to make sure it can't be overwhelmed by such I/O operations.

The cache grows and shrinks as needed. If the system begins to page a lot, the cache shrinks automatically. However, people often think they are seeing a lot of paging, but they are really seeing other disk activity, such as Windows 95 building its icon cache or the cache lazy writing.

If the amount of paging is extreme, to the point where system performance is poor, then you probably have a hard disk that requires a real-mode device driver. If Windows 95 needs to use real-mode for its disk I/O operations, then a lot of code has to be locked down that would otherwise be pageable, and your working set increases significantly. Paging through a real-mode driver does increase paging, but on a computer with 8 MB of memory, it shouldn't cause unacceptable performance.

Tip for 32-bit Disk Access in Windows 95

The 32-bit disk access feature is always turned on in Windows 95 unless Windows 95 detects a real-mode disk driver that doesn't have a protected-mode replacement. This could be, for example, an older Stacker® driver or a hard-disk security or encryption driver for a disk drive.

To prevent the performance loss that occurs when Windows 95 is forced to use a real-mode disk driver, upgrade to a protected-mode replacement for that driver. If you need to determine why a Windows 95 real-mode disk driver was installed, check the IOS.LOG file. For more information, see [Devices](#).

In Windows 95, file system and disk performance can be controlled based on how the computer is used in most situations. The option for configuring file system performance is controlled only by the user. None of these settings are affected by other configuration changes that might be made in Windows 95, such as installing File and Printer Sharing services, or choosing the Portable option as the setup type when installing Windows 95.



To optimize file system performance

1. In the System option in Control Panel, click the Performance tab, and then click the File System.
2. In the list named Typical Role Of This Machine, select the most common role for this computer, and then click OK. The following table describes each role in the list.

Role	Description
Desktop Computer	A normal computer acting primarily as a network client, or an individual computer with no networking. This configuration assumes there is more than the minimum required RAM, and that the computer is running on power (rather than battery).
Mobile Or Docking System	Any computer with limited memory. This configuration assumes limited RAM and that the computer is running on battery, so the disk cache should be flushed frequently.
Network Server	A computer used primarily as a peer server for file or printer sharing. This configuration assumes that the computer has adequate RAM and frequent disk activity, so the system is optimized for a high amount of disk access.

Each disk performance profile adjusts the values of the following file-system settings in the Registry:

- **PathCache**, which specifies the size of the cache that VFAT can use to save the locations of the most recently accessed directory paths. This cache improves performance by reducing the number of times the file system must seek paths by searching the file allocation table. The number of paths is 32 for the Desktop computer profile, 16 for Mobile Or Docking System, and 64 for Network Server.
- **NameCache**, which stores the locations of the most recently accessed filenames. The combined use of PathCache and NameCache means that VFAT never searches the disk for the location of cached filenames. Both PathCache and NameCache use memory out of the general system heap. The number of filenames is about 677 names (8 KB) for the Desktop computer profile, 337 names (4 KB) for Mobile Or Docking System, and 2729 names (16 KB) for Network Server.
- **BufferIdleTimeout**, **BufferAgeTimeout**, and **VolumIdleTimeout**, which control the time between when changes are placed in the buffer to when they are written to the hard disk.

The values to be assigned to each disk performance profile are stored in the following Registry key:

```
Hkey_Local_Machine\Software\Microsoft\Windows\CurrentVersion
  \FS Templates
```

The following subkey contains the actual settings for the profile currently used:

```
Hkey_Local_Machine\System\CurrentControlSet\Control\FileSystem
```

An additional performance setting in the FileSystem subkey, **ContigFileAllocSize**, can be used to change the size of the contiguous space that VFAT searches for when allocating disk space. Under MS-DOS, the file system began allocating the first available space found on the disk, which ensured a great deal of disk fragmentation and related performance problems. By default under Windows 95, VFAT first tries to allocate space in the first contiguous 0.5 MB of free space, then returns to the MS-DOS method if it can't find at least this much contiguous free space. This optimizes performance for both the swap file and multimedia applications.

In some cases, you might choose to set a smaller value in the Registry, such as if you are not running demanding applications on the computer. A smaller value for **ContigFileAllocSize**, however, can lead

to more fragmentation on the disk and, consequently, more disk access for the swap file or applications that require larger amounts of disk space.

Optimizing CD-ROM File System Performance

The CD-ROM cache is separate from the cache used for disk file and network access because the performance characteristics of the CD-ROM are different. This cache can be paged to disk (the file and network cache cannot), which reduces the working set for Windows 95 but still allows for better CD-ROM performance. When Windows 95 is retrieving data from a compact disc, it is still faster to read a record from the cache even if it's been paged to disk because the disk-access time is much faster than the compact-disc access time.

Tip A small CD-ROM cache makes a big difference in streaming performance, but a much larger cache does not pay off as significantly, unless the cache is large enough to contain entire multimedia streams.



To set the supplemental cache size for CDFS

1. In the System option in Control Panel, click the Performance tab, and then click the File System button.
2. In the CD-ROM Optimization area, drag the slider to set the supplemental cache size.

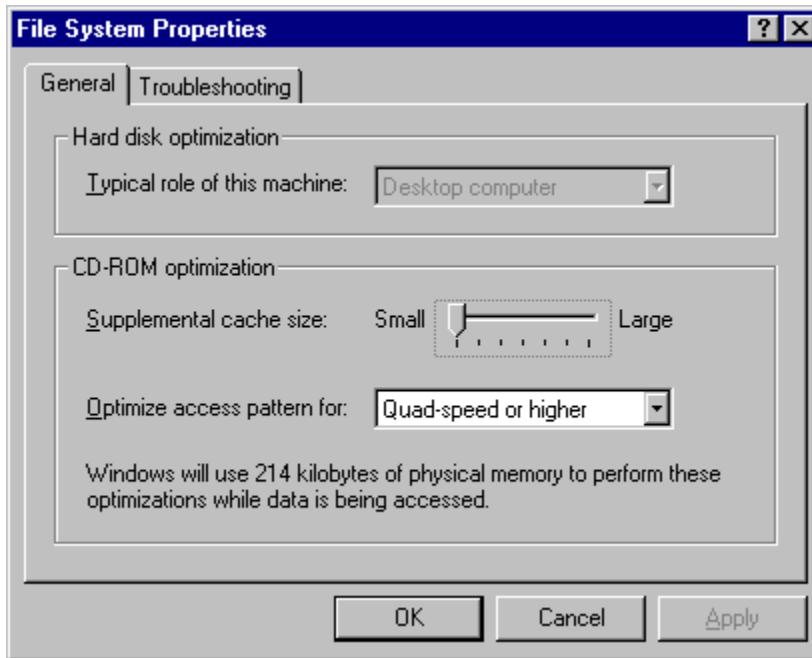

3. In the Optimize Access Pattern For list, select a setting based on the size of your computer's RAM and CD-ROM access speed. The following list shows recommended settings related to RAM size and the size of the cache that's created.

RAM size	Optimize setting	Cache size
8 MB or less	Single-speed drives	64K
8 MB to 12 MB	Double-speed drives	626K
12 MB or more	Quad speed or higher	1238K

4. Click OK, and then shut down and restart the computer.

For information about how VCACHE and the supplemental CD-ROM cache work, see [Disks and File Systems](#).

Using File-System Troubleshooting Options

The System option in Control Panel presents a set of options for changing file system performance. You can use these options when you experience rare hardware or software compatibility problems.

Important Enabling any of the file-system Troubleshooting options will seriously degrade system performance. Typically, you want to enable these options only if instructed to do so by your product support representative.



To display the file-system Troubleshooting options

1. In the System option in Control Panel, click the Performance tab.
2. Click the File System button, and then click the Troubleshooting tab.

The following table summarizes the settings in Troubleshooting properties. Each option sets a value in this Registry key:

Hkey_Local_Machine\System\CurrentControlSet\Control\FileSystem

File system option	Description
Disable New File Sharing And Locking Semantics	This option alters the internal rules for file sharing and locking on hard disks, governing whether certain processes can have access to open files in certain share modes that guarantee a file will not be modified. This option should be checked only in the rare case that an MS-DOS-based application has problems with sharing under Windows 95. This sets SoftCompatMode=0 in the Registry.
Disable Long Name Preservation For Old Programs	This option turns off the tunneling feature, which preserves long filenames when files are opened and saved by applications that do not recognize long filenames. This option should be checked in the rare case that an important legacy application is not compatible with long filenames. This sets PreserveLongNames=0 in the Registry.
Disable Protected-Mode Hard Disk Interrupt Handling	This option prevents Windows 95 from terminating interrupts from the hard disk controller and bypassing the ROM routine that handles these interrupts. Some hard disk drives might require this option to be checked in order for interrupts to be processed correctly. If this option is checked, the ROM routine handles the interrupts, which slows system performance. This sets VirtualHDIRQ=1 in the Registry. (This setting is off by default for all computers in Windows 95, which is the reverse of Windows 3.x.)
Disable All 32-bit, Protected-Mode Disk Drivers	This option ensures that no 32-bit disk drivers are loaded in the system, except the floppy driver. Typically, you would check this option if the computer does not start due to disk peripheral I/O problems. If this option is enabled, all I/O will go through real-mode drivers or the BIOS. Notice that in this case, all disk drives that are visible only in protected mode will no longer be visible. This sets ForceRMIO=1 in the Registry.
Disable Write-	This option ensures that all data is flushed continually to

Behind Caching For All Drives the hard disk, removing any performance benefits gained from disk caching. This option should be checked only in the rare cases where you are performing risky operations and must ensure prevention of data loss. For example, a software developer who is debugging data at Ring 0 while creating a virtual device driver would check this option. This sets **DriveWriteBehind=0** in the Registry.

Performance Tuning

Setting Graphics Compatibility Options

In Windows 95, graphics hardware acceleration features can be turned off when system performance indicates incompatibility problems. Specifically, problems can occur when Windows 95 assumes a display adapter can support certain functionality that it cannot. In such cases, the side effects might be anything from small irregularities on the screen to system failure. You can disable hardware acceleration features of the display adapter so that the computer can still be used if there is a problem with the display adapter. If changing these settings fixes otherwise unexplained system crashes or performance problems, then the source of the problem is probably the computer's display adapter.



To change graphics performance settings

1. In the System option in Control Panel, click the Performance tab, and then click the Graphics button.
2. Drag the slider to change the hardware acceleration setting, as summarized in the following list. Then click OK.

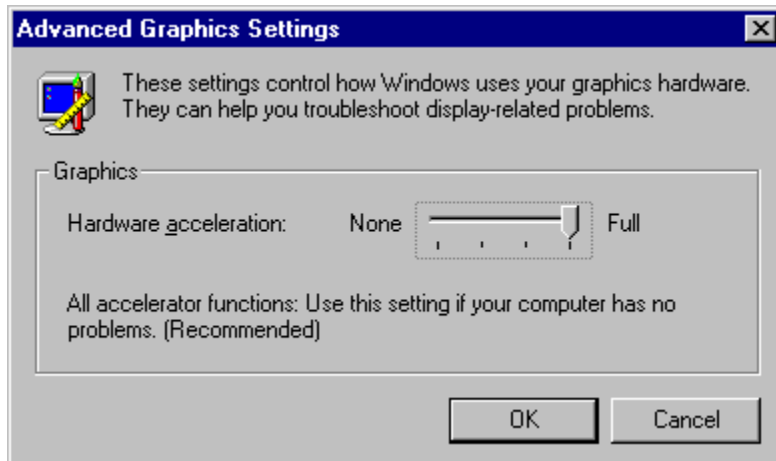

- The default setting is Full, which turns on all graphics hardware acceleration features available in the display driver.
- The first notch from the right can be set to correct mouse pointer display problems. This setting disables hardware cursor support in the display driver by adding **SwCursor=1** to the [Display] section of SYSTEM.INI.
- The second notch from the right can be set to correct certain display errors. This setting prevents some bit block transfers from being performed on the display card and disables memory-mapped I/O for some display drivers. This setting adds **SwCursor=1** and **Mmio=0** to the [Display] section of SYSTEM.INI, and **SafeMode=1** to the [Windows] section of WIN.INI.
- The last notch from the right (None) can be set to correct problems if your computer frequently stops responding to input, or has other severe problems. This setting adds **SafeMode=2** in the [Windows] section of WIN.INI, which removes all driver acceleration support and causes Windows 95 to use only the DIB engine rather than bit block transfers for displaying images.

For example, if you receive an error message at system startup stating that an application caused "an invalid page fault in module <unknown>," this indicates a problem between the display driver and the Windows 95 DIB engine. In such cases, this setting should correct the problem.

For more information about the built-in graphics performance features in Windows 95, see [Devices](#), and [Windows 95 Architecture](#).

Optimizing Printing

Printing to a printer attached to a file or print server occurs differently, depending on the server's operating system. If you print to a server running Windows 95, the rendering from the EMF format to the printer-specific language happens on the server. This means that less work is performed on the client computer, giving the user better performance.

When you print to NetWare or Windows NT servers, the rendering from EMF to the printer-specific format happens on the client computer. Although this happens in the background, it still means more work is performed on the client computer. Printing to a printer attached locally causes both the EMF rendering and the device-specific rendering to happen on the computer. For more information, see [Printing and Fonts](#).

You also need to decide on the trade-off between disk use and return-to-application time when configuring printing in Windows 95.



To define spool settings for print performance

1. In the Printers option in Control Panel, right-click the printer icon, and then click Properties.
2. Click the Details tab, and then click Spool Settings.

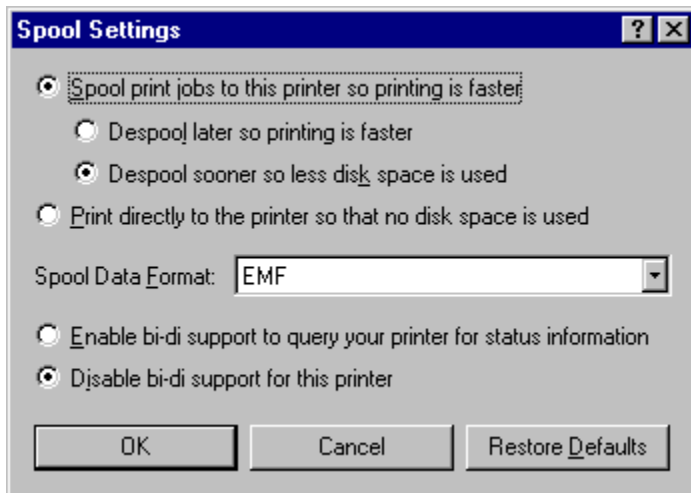

3. Select Spool Print Jobs So Program Finishes Printing Faster, and then click one of the following options:
 - Click Start Printing After Last Page Is Spooled if you want the return-to-application time to be faster. This requires more disk space and increases the total print time. The second rendering does not start until the entire file is written to the EMF file, which decreases the amount of work performed on the computer as you print but increases the disk space because the entire file has to be written before the second rendering starts.
 - Click Start Printing After Page Is Spooled if you want the second rendering to take place simultaneously with the writing of the EMF file. This reduces the total print time and disk space required, but it increases the return-to-application time.

Optimizing Network Performance

Windows 95 automatically adjusts system parameters to accommodate user demands and various network configurations. For example, it alters the size of the system paging file and cache buffer as memory requirements change and automatically tunes network time-out values to fit varying LAN topologies.

With a few exceptions, manual tuning of operating system parameters is not required to improve network performance. However, you can take several other measures that can increase file-sharing performance, such as reconfiguring or changing hardware components. This section summarizes these measures.

- Use a 32-bit, protected-mode network client.

For example, the Microsoft Client for NetWare Networks significantly out-performs the VLM or NETX version of the NetWare client. On large block transfers over the network, Client for NetWare Networks is up to twice as fast as Windows 3.x with the VLM shell, based on benchmarks performed by beta testers. The protected-mode networking client can take advantage of caching and other automatic tuning features. With a real-mode client, you are limited to the same performance tuning capabilities that were available under Windows 3.x.

- Use the new NDIS 3.1 network adapter drivers provided with Windows 95.
- Install a new network adapter. The adapters currently available provide markedly better performance than earlier models. If possible, select an adapter that matches the computer bus. For more information, see [Network Technical Discussion](#).

Network adapters have become exceptionally reliable and inexpensive. The low costs of Ethernet adapters, including new Plug and Play hardware, means that usually the most cost-effective way to improve network performance is to replace an older network adapter with a new model. The cost for the new hardware is offset almost immediately by savings in support time and improved performance.

The following measures can help you obtain the best performance from computers that provide File and Printer Sharing services:

- Let Windows 95 determine the right size for the swap file.
- Make sure the computer has enough memory, depending on the size of your network and the number of users who will be accessing the peer server.
- In the System option in Control Panel, set the typical role of the computer to Network Server, as described in [Optimizing File System Performance with Profiles](#).
- Install a high-performance network adapter on the peer server. If the computer uses an 8-bit adapter, you can increase performance significantly by replacing it with a high-performance 16-bit or 32-bit adapter.
- Disable rarely used network adapters. This improves overall network performance by decreasing the number of broadcast packets on the network. Each broadcast packet must be processed by every active adapter on the network. High broadcast rates adversely affect LAN performance by increasing network connection time. You can disable a network adapter by disabling its binding to protocols in the Network option in Control Panel.
- Install faster hard disks or disk controllers (or both). Typically, when setting up peer servers, you will want to choose computers configured with the best-performing hardware.
- On a computer running File and Printer Sharing for NetWare Networks, set the read-only attribute on shared files wherever possible. The network client can take better advantage of file caching with read-only files, which will improve network performance and reduce the load on the server.

Optimizing Conventional Memory

The methods for conventional memory management under Windows 95 are the same as for MS-DOS 6.x:

- In CONFIG.SYS, load **himem** and **emm386** (using either the **ram** or **noems** switches), and load any required real-mode drivers and applications using **devicehigh** or **loadhigh** statements.
- Remove as many real-mode drivers and TSRs from CONFIG.SYS and AUTOEXEC.BAT as possible, and instead use new protected-mode drivers and applications created for Windows 95.
- Use **bufferhigh**, **fcshigh**, **fileshigh**, **lastdrivehigh**, and **stackhigh** to ensure that reserved memory is taken out of the upper memory area. For information about these commands, see [Command-Line Commands Summary](#).
- Do not load **smartdrv** in your configuration files, except in configuration files for an application that you run in MS-DOS Mode. Windows 95 uses an improved method for disk caching, so loading **smartdrv** typically wastes memory that could be used by MS-DOS-based applications.

You can still run the MEMMAKER utility provided with MS-DOS 6.2x to load real-mode drivers in the upper memory blocks (UMB). This utility is available in the OTHEROLDDOS directory on the Windows 95 compact disc.

For information about MS-DOS Mode, and other configuration issues related to MS-DOS-based applications, see [Application Support](#). For specific information about MS-DOS memory settings, consult the *Microsoft MS-DOS 6.2 Technical Reference* or other books on MS-DOS memory management.

Tip for MS-DOS Mode

Don't assume that running an MS-DOS-based application in MS-DOS Mode provides better performance. When an application runs in MS-DOS Mode, Windows 95 and all of its protected-mode drivers are unloaded, so the application is running in real mode with exclusive use of the computer's resources.

Although this might help with a few applications that otherwise cannot run under Windows 95, it does not benefit performance overall because the application doesn't get the benefit of protected-mode drivers, VCACHE, 32-bit disk access, and so on. Also, real-mode device drivers must be loaded, reducing the amount of conventional memory available to the application.

Tracking Performance with System Monitor

System Monitor is a Windows 95 tool you can use to help determine the cause of problems on a local or remote computer by measuring the performance of hardware, software services, and applications. When you make changes to the system configuration, System Monitor shows the effect of your changes on overall system performance. You can also use System Monitor to justify hardware upgrades.

Before making major configuration changes, use System Monitor to evaluate your current configuration; this can help you determine whether a particular system or network component is acting as a performance bottleneck.



To install and run System Monitor

1. In the Add/Remove Programs option in Control Panel, click the Windows Setup tab.
2. In the Components list, make sure Accessories is checked, and then click Details.
3. In the Components list, make sure System Monitor is checked, and then click OK.
4. To install System Monitor, click OK.
5. To run System Monitor, click the Start button, click Run, and then type **sysmon**



To use System Monitor to monitor remote computers

1. Install the Microsoft Remote Registry service on your computer and on the computer you want to monitor, as described in [Remote Administration](#).
2. Click the File menu, and then click Connect.
3. Type the computer name of the computer you want to monitor, and then click OK.

Notice that monitoring a remote computer requires user-level security.

Performance Tuning

Tracking Performance with System Monitor

Configuring Performance Charts in System Monitor

System Monitor uses the dynamic data information in the Registry to report on the state of processes. You can use System Monitor to do the following:

- Monitor real-time system performance and compare it with historical performance to help identify trends over time.
- Determine system capacity and identify bottlenecks.
- Monitor the effects of system configuration changes.



To use System Monitor to track performance problems

1. Click the Edit menu, and then click Add Item.
2. In the Category list, click the resource that you want to monitor.
3. In the Item list, select one or more resources that you want to monitor.

To select more than one item, press CTRL while clicking the items that you want to select. To select several items in a row, click the first item, and then press and hold down SHIFT while clicking the last item.

For more information about a selected resource, click the Explain button, which is dimmed until after step 3.

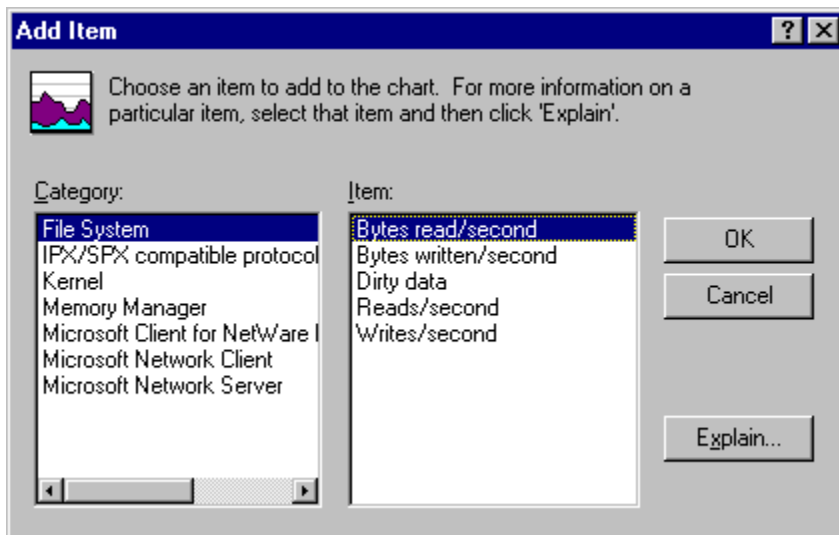

4. Click OK.

To change the view of the data from a line chart to a bar chart or a numeric listing, click the related button on the button bar.

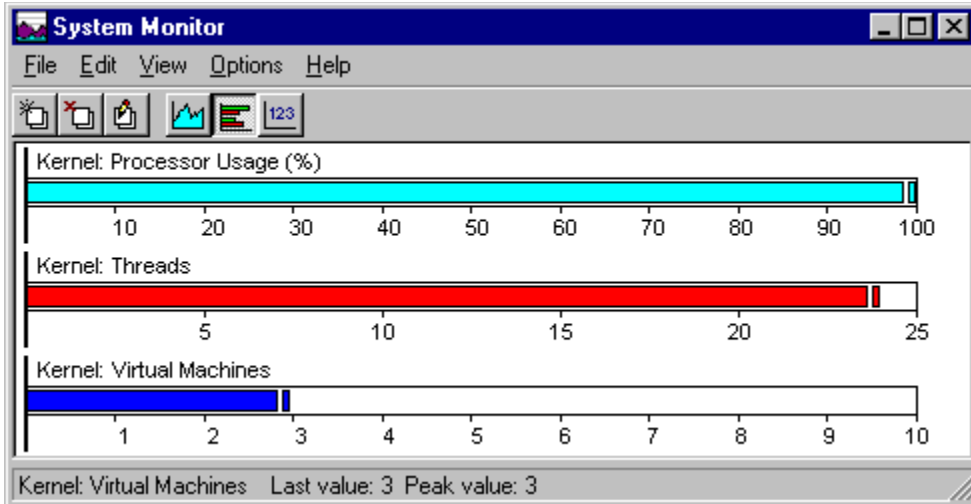

System Monitor offers menu commands for configuring the charts:

- To change the update interval, click the Options menu, and then click Chart.
- To configure the color and scaling for a selected item, click the Edit menu, and then click Edit Item.
- To control the display of the toolbar, status bar, and title bar, click the View menu, and then click Toolbar, Status Bar, or Hide Title Bar, respectively.

Performance Tuning

Tracking Performance with System Monitor

Identifying Performance Problems with System Monitor

If you want to use System Monitor effectively, you need to run it frequently to become familiar with what typical performance looks like for a standard configuration so that you can recognize performance problems when they appear in System Monitor.

To become well-acquainted with System Monitor, run it while you are doing your usual work under Windows 95. To do this, add the System Monitor icon to your desktop. Then run System Monitor and use commands on the View menu to remove the title bar or to force the window to be always on top.

The following presents some general guidelines and key settings for using System Monitor in troubleshooting performance problems:

- If you suspect an application might not be freeing memory when it finishes using it (sometimes called memory leaks), monitor the value of Kernel: Threads over time. This will indicate whether the application is starting threads and not reclaiming them. Windows 95 automatically removes such threads when the application closes, but if you identify a leak while the application is running, you might decide that you should restart the application periodically.
- If the values for Memory Manager: Discards and Memory Manager: Page-outs indicate a great deal of activity, performance problems might be related to system memory stress. These values might indicate a need for more physical memory.
- If a computer seems slow, check the values reported by Kernel: Processor Usage (%) and by Memory Manager: Page Faults and Memory Manager: Locked Memory, as described in the following list:
 - If values for Kernel: Processor Usage are high even when the user is not working, check to see which application might be keeping it busy. To do this, press CTRL+ALT+DEL to see the list of tasks in the Close Program dialog box.
 - If the values for Memory Manager: Page Faults are high, it might indicate that the applications being used have memory needs that are beyond the computer's capabilities.
 - If the Memory Manager: Locked Memory statistics continually are a large portion of the Memory Manager: Allocated Memory value, then inadequate free memory might be affecting performance. Also, you might be running an application that locks memory unnecessarily. (Locked memory indicates the portion of memory used that cannot be paged out.)

The following basic example shows several memory management statistics over a few minutes while Windows-based word processing, spreadsheet, and mail applications were loaded and several files were opened.

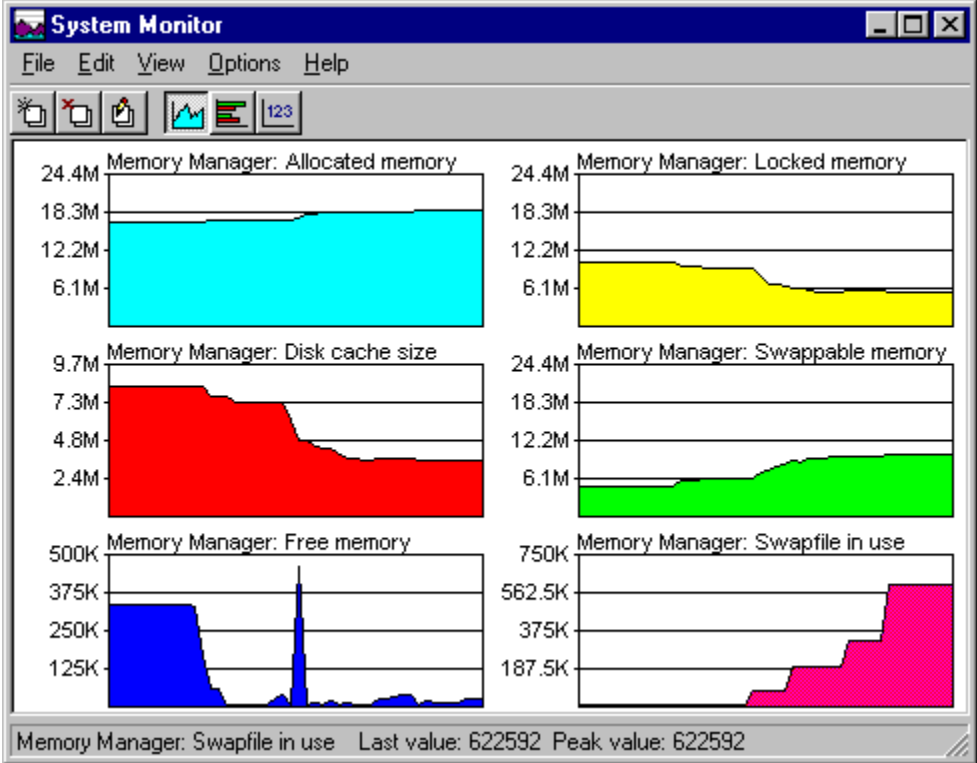

Summary of System Monitor Categories

System Monitor tracks functionality for the following categories:

- File System
- IPX/SPX Compatible Protocol
- Kernel
- Memory Manager
- Microsoft Client for NetWare Networks and Microsoft Network Client
- Microsoft Network Server (File and Printer Sharing service)
- Microsoft Network Monitor Performance Data

Note Because System Monitor uses Registry information, drivers can be written to report additional information in System Monitor. For information about creating such drivers, see the *Windows 95 Device Development Kit*.

The following tables describe the settings for the built-in System Monitor categories.

File System

Setting	Description
Bytes Read/Second	The number of bytes read from the file system each second.
Bytes Written/Second	The number of bytes written by the file system each second.
Dirty Data	The number of bytes waiting to be written to the disk. Dirty data is stored in cache blocks, so the number reported might be larger than the actual number of bytes waiting.
Reads/Second	The number of read operations delivered to the file system each second.
Writes/Second	The number of write operations delivered to the file system each second.

IPX/SPX Compatible Protocol

Setting	Description
IPX Packets Lost/Second	The number of IPX packets received by the computer from an IPX network that were ignored.
IPX Packets Received/Second	The number of packets received by the computer from an IPX network each second.
IPX Packets Sent/Second	The number of packets sent by the computer to an IPX network each second.
Open Sockets	The number of free sockets.
Routing Table Entries	The number of IPX interworking routes known.
SAP Table Entries	The number of service advertisements known.
SPX Packets Received/Second	The number of packets received by the computer from an SPX network each second.
SPX Packets Sent/Second	The number of packets sent by the computer to an SPX network each second.

Kernel

Setting	Description
Processor Usage (%) ¹	The approximate percentage of time the processor is busy.
Threads	The current number of threads present in the system.
Virtual Machines	The current number of virtual machines present in the system.

¹ Monitoring processor usage will increase processor usage slightly, so don't monitor this setting unless you are investigating a problem.

Memory Manager (VMM32)

Setting	Description
Allocated Memory ^{1, 2}	The total amount in bytes of Other Memory and Swappable Memory. If this value is changing when there's no activity on the computer, it indicates that the disk cache is resizing itself.
Discards	The number of pages discarded from memory each second. (The pages aren't swapped to the disk because the information is already on the disk.)
Disk Cache Size	The current size, in bytes, of the disk cache.
Free Memory	The total amount of free RAM, in bytes. This number is not related to Allocated Memory. If this value is zero, memory can still be allocated, depending on the free disk space available on the drive that contains the swap file.
Instance Faults	The number of instance faults each second.
Locked Memory ¹	The amount of allocated memory that is locked.
Maximum Disk Cache Size	The largest size possible for a disk cache. This is a fixed value loaded at system startup.
Minimum Disk Cache Size	The smallest size possible for a disk cache. This is a fixed value loaded at system startup.
Other Memory ¹	The amount of allocated memory not stored in the swap file; for example, code from Win32 DLLs and executable files, memory mapped files, nonpageable memory, and disk cache pages.
Page Faults	The number of page faults each second.
Page-ins	The number of pages swapped into memory each second, including pages loaded from a Win32-based executable file or memory-mapped files. Consequently, this value does not necessarily indicate low memory.
Page-outs	The number of pages swapped out of memory and written to disk each second.
Swapfile Defective	The number of bytes in the swap file that are found to be physically defective on the swap medium. Because swap file frames are allocated in 4096-byte blocks, a single damaged sector causes the whole block to be marked as defective.
Swapfile In Use	The number of bytes being used in the current swap file.
Swapfile Size	The size, in bytes, of the current swap file.
Swappable Memory ¹	The number of bytes allocated from the swap file. Locked pages still count for the purpose of this metric. This includes code from 16-bit applications and DLLs, but not code from Win32 DLLs and executable files.

- 1 This number includes the disk cache. To see the actual size, subtract the value of Disk Cache Size.
- 2 For any Windows-based application that uses common dialog boxes, the spooler, OLE, and so on, handles are cached for later use, so not all resources will be freed when the application closes.

Microsoft Client for NetWare Networks

Setting	Description
Burst Packets Dropped	Number of burst packets from this computer lost in transit.
Burst Receive Gap Time	Interpacket gap for incoming traffic, in microseconds.
Burst Send Gap Time	Interpacket gap for outgoing traffic, in microseconds.
Bytes In Cache	Amount of data, in bytes, currently cached by the redirector.
Bytes Read Per Second	Bytes read from the redirector per second.
Bytes Written Per Second	Bytes written to the redirector per second.
Dirty Bytes In Cache	Amount of dirty data, in bytes, currently cached by the redirector and waiting to be written.
NCP Packets Dropped	Number of regular NCP packets lost in transit.
Requests Pending	Number of requests waiting to be processed by the server.

Microsoft Network Client (Client for Microsoft Networks)

Setting	Description
Bytes Read/Second	The number of bytes read from the redirector each second.
Bytes Written/Second	The number of bytes written to the redirector each second.
Number Of Nets	Number of networks currently running.
Open Files	Number of open files on the network.
Resources	Number of resources.
Sessions	Number of sessions.
Transactions/Second	The number of SMB transactions managed by the redirector each second.

Microsoft Network Server (File and Printer Sharing for Microsoft or NetWare Networks)

Setting	Description
Buffers	The number of buffers used by the server.
Bytes Read/Sec	The total number of bytes read from a disk.
Bytes Written/Sec	The total number of bytes written to a disk.
Bytes/Sec	The total number of bytes read from and written to a disk.
Memory	The total memory used by the server.
NBs	Server network buffers.
Server Threads	The current number of threads used by the server.

Microsoft Network Monitor Performance Data¹

Setting	Description
<i>Mediatype</i> ² broadcasts/sec	Broadcast frames transmitted over the network adapter per second.
<i>Mediatype</i> bytes/sec	Total bytes transmitted over the network adapter per second.
<i>Mediatype</i> frames/sec	Total frames transmitted over the network adapter per second.
<i>Mediatype</i> multicasts/sec	Total multicast frames transmitted over the network adapter per second.

1 Gathering these statistics on a heavily used, low-performance computer will impact performance.

2 *Mediatype* can be Ethernet or TokenRing.

System Configuration

This part of the *Windows 95 Resource Kit* contains the following chapters, describing how to manage your system configuration under Windows 95.

Chapter 18 Introduction to System Configuration

Presents some background technical information related to Plug and Play-compliant devices and other device configuration components in Windows 95.

Chapter 19 Devices

Presents an overview of issues related to both Plug and Play-compliant and legacy devices, and provides specific details for installing and configuring devices, including PCMCIA cards, display adapters, the mouse, and communications ports.

Chapter 20 Disks and File Systems

Describes how to use Fdisk, Format, DriveSpace, Disk Defragmenter, and ScanDisk to manage disks and data. This chapter also introduces the Windows 95 file system and provides information for using long filenames among many users.

Chapter 21 Multimedia

Describes the multimedia architecture and features in Windows 95.

Chapter 22 Application Support

Provides tips for making applications based on Win32, Win16, and MS-DOS run well under Windows 95.

Chapter 23 Printing and Fonts

Describes the improvements in the printing subsystem and explains how to set up printers with Windows 95. It also describes font support in Windows 95.

Introduction

This chapter presents overview information about configuring hardware and software for use with Windows 95. It also provides some background information about device support and Plug and Play features within Windows 95.

- System Configuration Overview
- Improved Device Support in Windows 95
- Windows 95 Device Classes
- Plug and Play Support in Windows 95
- Plug and Play Device Types
 - ISA Devices
 - EISA Devices
 - SCSI Devices
 - PCMCIA Devices
 - VL and PCI Devices
 - Other Device Types

System Configuration Overview

Windows 95 includes several tools and built-in features that make it easy to configure the hardware and software on a computer.

Automatic hardware detection.

Hardware designed to work with Windows 95 is virtually self-configuring. When you run Windows 95 Setup, an automatic hardware detection routine determines the hardware components that are installed. Whether your system includes Plug and Play-compliant or legacy components, Windows 95 can automatically detect and configure them. Windows 95 Plug and Play features are described in [Plug and Play Support in Windows 95](#). For more information about hardware detection during Setup, see [Setup Technical Discussion](#).

Configuration wizards.

Windows 95 includes wizards for installing new hardware, adding modems and printers, and installing applications. These tools lead you through the steps for configuring the new component on a computer.

Point and print.

When you copy a printer icon from the server's window to your own Printers window or desktop, Windows 95 automatically installs the correct printer driver and configures the network connection to a network printer.

Control Panel options for system configuration.

The Control Panel includes several tools for configuring various parts of your system. The following table describes some Control Panel tools.

Icon	Description of tool
<input type="checkbox"/>	Accessibility Options. Use this tool to adjust keyboard, sound, display, mouse, and general options to make Windows 95 easier to use for individuals with disabilities. For information, see Accessibility .
<input type="checkbox"/>	Add New Hardware. Use this wizard to configure newly installed hardware through detection or by selecting the corresponding driver from a list. For information, see Devices .
<input type="checkbox"/>	Add/Remove Programs. Use this wizard to install a program from a setup disk. You can also remove any application installed with this tool, add components from the Windows 95 disks, or create a new startup disk. For information, see Application Support .
<input type="checkbox"/>	Display. Use this tool to change background and screen saver choices. Modify settings for on-screen fonts, colors, color palette, and so on. For information on configuring the display, see Devices .
<input type="checkbox"/>	Fonts. Use this tool to view installed fonts or install new fonts. For more information, see Printing and Fonts .
<input type="checkbox"/>	Keyboard. Use this tool to change options for the style of keyboard you use and for the rate at which the characters you type are displayed. For information, see online Help.
<input type="checkbox"/>	Modems. Use this wizard to add a new modem. You can also use this tool to configure or diagnose installed modems. For more information, see Modems and Communications Tools .
<input type="checkbox"/>	Mouse. Use this tool to change mouse or pointer options. (The appearance of the icon might be different, depending on the type of mouse used.) For information, see Devices .
<input type="checkbox"/>	Multimedia. Use this tool to change options for audio playback and recording, MIDI output and schemes, and CD playback volume. Use the Advanced properties to install or configure multimedia

- hardware, drivers, and codecs. For information, see [Multimedia](#).
- Printers. Use this tool to configure existing printers or add a new printer. For more information, see [Printing and Fonts](#).
- Sound. Use this tool to create or modify sound schemes. (This is available to users who have sound cards on their computers.) For information, see online Help.
- System. Use this tool to view general information about your computer. Use Device Manager to list or configure hardware properties. You can also list, copy, or rename hardware profiles and view performance status settings. For information, see [Devices](#).

Introduction to System Configuration

Improved Device Support in Windows 95

Windows 95 provides improved support for hardware and peripheral devices, including disk devices, display adapters, pointing devices, modems and other communications devices, and printers.

Mini-driver architecture for reliable drivers.

Windows 95 extends the mini-driver architecture for printer drivers used in Windows 3.1 throughout the operating system to the architecture for drivers of other system components, resulting in increased driver stability and forward compatibility. Although it is still possible to write and use monolithic drivers in Windows 95, Microsoft recommends that hardware manufacturers use the mini-driver model.

Improved support through Plug and Play.

Plug and Play is designed so that adding a device, either permanently or dynamically, requires nothing more than taking it out of the box and plugging it in. The computer and operating system seamlessly adjust to the new configuration. When using Plug and Play-compliant hardware, users will no longer be required to manually set jumpers and switches to redirect IRQs, DMA channels, or I/O port addresses. This saves time and expense in service calls related to hardware configurations.

Plug and Play is also a benefit to users who install Plug and Play-compliant devices into older, legacy computers. Information about these devices is stored centrally in the Registry, and devices that cannot be reconfigured dynamically receive first priority when resources are allocated.

The Registry and Device Manager for resource management.

To properly manage resources such as IRQs, I/O addresses, and DMAs, Windows 95 uses the Registry to track devices and resources allocated for both Plug and Play-compliant devices and legacy devices. The Registry provides a centralized, dynamic data store for all Windows settings, with a "current configuration" branch that stores information on a per-configuration basis. For example, the Display option in Control Panel stores per-configuration information about display resolution changes and Print Manager stores per-configuration information about the default printer.

Device Manager — which is available from the System icon in Control Panel — provides a graphical representation of devices configured in Windows 95, and allows properties used by these devices to be viewed and changed, as appropriate. Device Manager also shows resources allocated for the configured devices. Through the resource configuration information maintained in the Registry, Windows 95 is able to automatically identify and resolve device resource conflicts for Plug and Play-compliant devices. For legacy devices, Device Manager helps users quickly identify and resolve resource conflicts with devices in the system.

Virtual device drivers.

Windows 95 uses virtual device drivers (VxDs) where possible to provide improved performance. VxDs replace the real-mode MS-DOS device drivers used in previous versions of Windows for the following:

- MS-DOS FAT file system
- SMARTDrive
- CD-ROM file system
- Network drivers and network transport protocols
- Network client and peer resource sharing server

- Mouse driver
- MS-DOS file sharing and locking support (SHARE.EXE)
- Disk device drivers, including support for SCSI devices
- DriveSpace (and DoubleSpace) disk compression

Windows 95 provides device driver and TSR functionality as protected-mode components that reside in extended memory, avoiding context switches between protected-mode and real-mode when running 32-bit applications. Use of VxDs also improves system stability and reliability over using the MS-DOS device drivers.

PCMCIA support.

Windows 95 delivers power, compatibility, ease of installation, and dynamic card insertion and removal to PCMCIA users. PCMCIA drivers in Windows 95 are robust, 32-bit, dynamically loadable virtual device drivers that use no conventional memory. Windows 95 includes an updated version of Card and Socket services to support PCMCIA.

To install a PCMCIA device, just insert the card in the computer. For example, when you plug in a PCMCIA network adapter, Windows 95 detects the network adapter, loads the network drivers, and establishes a network connection. Then the user interface is updated to show that the mapped network drives are now active. With earlier versions of Windows or other operating systems, you had to shut down and restart the computer to begin using the device.

Hot docking support.

Plug and Play allows “hot docking” (that is, docking with the device powered on) and insertion of devices. This means that when a device is inserted, the operating system recognizes the new device, its capabilities, and its requirements, and loads the appropriate driver without requiring the user to restart the system unless the required resources are not available to the new device. Applications are notified about dynamic events, so they can take advantage of the new functionality or stop attempting to use unavailable devices. Instead of changing configuration files and restarting the computer, a user working at a docking station can click Eject PC on the Start menu.

Windows 95 Device Classes

Devices and buses are grouped as classes in Windows 95, for purposes of installing and managing device drivers and allocating resources. The Registry contains a subkey for every class of device supported, and the hardware tree (as described in the following section) is organized by device class. Windows 95 uses class installers to install drivers for all hardware classes. Device Manager, for example, sends messages to the various class installers to tell them to add, remove, or configure specific hardware.

The following are some examples of class names defined in Windows 95.

Adapter	Keyboard	Mouse	PCMCIA
Cdrom	MCADevices	MTD	Ports
Display	Media	Net	Printer
EISAdvices	Modem	NetService	SCSIAdapter
FDC	Monitor	Nodriver	System
HDC			

The Windows 95 hardware tree is a record of the current system configuration, based on the configuration information for all devices in the hardware branch of the Registry. The hardware tree is created in RAM each time the system is started or whenever a dynamic change occurs to the system configuration.

Each branch in the tree defines a device node with the following requirements for configuration:

- Unique identification code, or device ID
- List of required resources, including the resource type (such as IRQ and memory range) and constraints on specific resources (such as a COM port that requires IRQ3)
- List of allocated resources
- Indication that the device node is a bus, if applicable (each bus device has additional device nodes under it in the tree)

Tip for Viewing the Hardware Tree

Most information in the Windows 95 hardware tree can be seen by using Device Manager, which you can display by choosing the System option in Control Panel. Device Manager is described in [Devices](#).

You can also see the information in the hardware tree in the Hkey_Dyn_Data\Dynamic\Enum section of the Windows 95 Registry.

The configuration process in Windows 95 uses the device nodes to identify the devices and resource requirements for establishing the working system configuration. For information about the components that work together in Windows 95 to configure the system, see [Windows 95 Architecture](#).

Plug and Play Support in Windows 95

Plug and Play is an independent set of computer architecture specifications that hardware manufacturers use to produce computer devices that can be configured with no user intervention.

For Plug and Play-compliant devices, installation consists of plugging in the device and turning on the computer. For example, a user can do the following:

- Insert and remove Plug and Play-compliant devices such as PCMCIA cards with automatic configuration.
- Connect to a docking station or network without restarting the computer or changing configuration parameters.
- Add a new monitor by plugging it in and turning it on.

The Plug and Play capabilities in Windows 95 have been widely described as key benefits to moving to Windows 95, because of the related reduction in hardware and software support costs. When Windows 95 detects the presence of a Plug and Play-compliant device, its device driver can be loaded and configured dynamically, requiring little or no user input. After the device and driver are installed, the driver reacts to system messages when a device is inserted or removed.

Microsoft recommends adding Plug and Play-compliant devices on legacy computers rather than adding non-Plug and Play devices. To use all Plug and Play features, however, your system must include a Plug and Play BIOS (the motherboard), devices (buses), and an operating system (Windows 95).

The following table compares the Plug and Play implementation in the Windows 95 operating system against other implementations.

Windows 95 Plug and Play

Dynamically loads, initializes, and unloads drivers in protected mode.

Supports a wide range of device types (as described in the following section).

Provides robust detection for devices, which is critical for Plug and Play on legacy computers.

Notifies other drivers and applications when a new device is available for use. Windows 95 also includes an automatic installation procedure to ensure that appropriate drivers are installed and loaded.

Provides robust, seamless operation through the integration of all subsystems and the startup process.

Provides an architecture with a consistent driver and bus interface for all devices.

Most other implementations

Run in real mode, with MS-DOS-based drivers loaded in CONFIG.SYS.

Include only basic PCI-based and ISA-based device configuration.

Do not provide hardware detection.

Configure device IRQ settings and so on, but the burden of installation falls on the user.

Might not be as reliable.

In real mode, do not provide a supporting architecture.

For additional details about the supporting architecture, see [Windows 95 Architecture](#).

Introduction to System Configuration

Plug and Play Device Types

A variety of devices are compliant with Plug and Play. The following sections describe the types of devices and provide details for Plug and Play versus legacy devices.

ISA Devices

Industry Standard Architecture (ISA) bus design is the architecture specified for the IBM® PC/AT®. Plug and Play ISA devices can be used on existing computers, because the specification does not require any change to ISA buses. To configure Plug and Play ISA devices, the system performs the following actions:

- Identifies and configures the devices using I/O ports, which enables the Plug and Play logic on the card
- Isolates each card and assigns a unique device ID and serial number
- Reads the resource requirements and capabilities stored on each card
- Allocates resources to each card, which reserves these resources so that other Plug and Play cards in the computer cannot be assigned these resources
- Activates the Plug and Play ISA cards

For legacy devices, standard ISA cards can coexist with Plug and Play ISA cards on the same computer. Windows 95 determines the type of hardware and its configuration during Setup, either by polling the hardware or asking the user to supply values. This configuration information is stored as static values in the Registry, and cannot be changed dynamically, but it is used to determine resource assignments for Plug and Play-compliant devices.

Introduction to System Configuration

Plug and Play Device Types

EISA Devices

Enhanced Industry Standard Architecture (EISA) is a bus design for x86-based computers, specified by an industry consortium. EISA devices use cards that are upwardly compatible from ISA. EISA devices use standard software mechanisms for identification and configuration. As such, they meet most of the Plug and Play requirements. Windows 95 includes a bus enumerator that makes configuration information from these devices accessible to the operating system. This means that Windows 95 does not reconfigure EISA cards, but instead uses the information that hardware detection derives from the EISA nonvolatile RAM storage to determine which resources are used.

SCSI Devices

Small Computer Standard Interface (SCSI) is a multiple-device chained interface used in many devices such as hard disks and CD-ROM drives. Plug and Play SCSI devices support dynamic changes to the adapter and automatic configuration of device ID and termination.

Configuration of a SCSI device can be separated into two distinct processes:

- Configuring the SCSI bus itself, such as terminating both ends of the SCSI bus and setting device IDs
- Configuring the SCSI host adapter, such as assigning an IRQ channel, DMA channel, and so on

Configuring a SCSI bus that is not Plug and Play-compliant is difficult for most users. The list of issues related to configuring a SCSI bus is long, including:

- SCSI device ID assignment
- Termination
- SCSI parity
- Command sets
- Disk geometry and software

For example, the SCSI-2 specification does not define an automated ID assignment mechanism, so the user is responsible for making sure that no two SCSI devices on the same SCSI bus share the same SCSI ID. Also, you might replace a SCSI host adapter with one from another company and find it doesn't work due to differences in disk geometries or the way devices are mapped to INT 13 parameters.

For more information about support for SCSI devices and drivers, see [Disks and File Systems](#).

PCMCIA Devices

PCMCIA devices meet the Personal Computer Memory Card International Association standard for the credit card-sized interface cards in portable computers and other small computers. PCMCIA technology supports all Plug and Play functionality. Windows 95 provides automatic installation and drivers for Intel-compatible and Databook-compatible PCMCIA sockets. Windows 95 also supports real-mode and protected-mode PCMCIA system software drivers (card services) from other vendors, but some of the Plug and Play capabilities will not be available, such as hot swapping of network adapters and automatic installation.

Windows 95 supports alternate system configurations for PCMCIA devices, depending on whether the PCMCIA device is docked. The alternate configurations are saved under unique identifiers in the hardware tree to be used for dynamic configuration. For more information, see [Devices](#).

Depending on how the hardware manufacturer uses the Plug and Play standard, a PCMCIA device driver might be combined with an ISA or an EISA driver for the card, or the system's generic driver can be used.

To take advantage of Plug and Play, a card must contain information that Windows 95 can use to create a unique device ID for the card. Device drivers can be implemented under three possible schemes, depending on how complete the Card Information Structure (CIS) is on the card, whether the driver requires memory services, and whether the drive is bus-sensitive:

- A standard Plug and Play device driver for PCMCIA (the preferred driver) can handle dynamic configuration and removal, and receive configuration information from the operating system without knowledge of the card in the PCMCIA bus. The recommended choices are NDIS 3.x drivers for network adapters and Windows NT miniport drivers for SCSI cards, which do not require PCMCIA-specific services such as memory buffers.
- Generic Windows 95 device drivers are supported automatically for devices such as modems and disk drives. If the card contains complete configuration information, the operating system initializes the device and passes configuration information to the driver.
- Manufacturer-supplied drivers are required for device classes such as network or SCSI adapters that require specific PCMCIA functions, such as memory-mapped I/O or memory window operations. Windows 95 supports these operations through the standard card services API.

Introduction to System Configuration

Plug and Play Device Types

VL and PCI Devices

The Video Electronic Standards Association (VESA) Local (VL) bus standard allows high-speed connections to peripherals. VL bus devices are not totally Plug and Play-compliant, but work similarly to ISA devices. The VL bus is used mostly to support high-performance video cards.

The Peripheral Component Interconnect (PCI) local bus is a standard used in most Pentium™ computers and in the Apple® PowerPC™ Macintosh® and is likely to be the successor to VL. Windows 95 does not reconfigure PCI cards, instead it uses the information that hardware detection derives from the PCI nonvolatile RAM storage to know what resources are used. The PCI bus architecture meets most Plug and Play requirements, and PCI devices use standard mechanisms for identifying themselves and declaring resource requirements.

PCI is usually a secondary bus. If its primary bus is not Plug and Play-compliant, the PCI bus cannot use Plug and Play functions.

Other Device Types

Other device types can take advantage of Plug and Play if they provide mechanisms for identification and configuration. These include IDE controllers, Extended Capabilities Ports (ECP), and communications ports.

Parallel ports, also known as LPT ports, can also take advantage of Plug and Play. The most common parallel port type is the Centronics® interface. Plug and Play parallel ports meet Compatibility and Nibble mode protocols defined in IEEE P1284. Compatibility mode provides a byte-wide channel from the computer to the peripheral. Nibble mode provides a channel from the peripheral to the host through which data is sent as 4-bit nibbles using the port's status lines. These modes provide two-way communication between the host and the peripheral. Nibble mode is also used to read the device ID from the peripheral for device enumeration.

For computers that are totally Plug and Play-compliant, the BIOS also meets Plug and Play specifications. In this case, the file named BIOS.VXD provides the BIOS Plug and Play enumerator.

Introduction

This chapter presents an overview of issues related to Windows 95 support for both Plug and Play-compliant and legacy devices. It also provides specific details for installing and configuring devices, including PCMCIA cards, display adapters, the mouse, and communications ports.

- [Devices: The Basics](#)
- [Devices: The Issues](#)
- [Devices Overview](#)
- [Installing New Devices](#)
- [Changing Settings with Device Manager](#)
- [Enabling PCMCIA Cards](#)
- [Using Hardware Profiles for Alternate Configurations](#)
- [Configuring the Display](#)
 - [Display Driver Overview](#)
 - [Changing the Display Type and Driver](#)
 - [Configuring Display Resolution and Color Palette](#)
 - [Configuring Display Appearance](#)
- [Configuring the Mouse](#)
 - [Mouse and Pointing Device Driver Overview](#)
 - [Changing Mouse Drivers](#)
 - [Configuring Mouse Behavior](#)
- [Configuring Communications Ports and Printer Ports](#)
- [Real-Mode Drivers and the IOS.INI Safe Driver List](#)
- [Troubleshooting Device Configuration](#)
 - [Correcting Problems with Display](#)
 - [Correcting Problems with SCSI Devices](#)
 - [Correcting Problems with Other Devices](#)

Devices: The Basics

These key features (and related benefits) result from the Windows 95 system design changes (as described in [Introduction to System Configuration](#)):

- Automatic installation for new Plug and Play-compliant devices, allowing the user to start working without configuring or, usually, without restarting the computer.
- Centralized places in the Registry and Device Manager to configure legacy devices and set preference for resources.
- Enhanced support for PCMCIA adapters, portable computers, and docking stations.

Windows 95 includes several tools to help install, configure, and manage hardware devices:

- The Add New Hardware option in Control Panel is a wizard that guides you through the steps required to install and configure drivers for legacy devices. For information, see the summary later in this section, plus [Installing New Devices](#).
- You can view the hierarchy of devices in the system and print various reports on system settings using Device Manager in the System option in Control Panel. For information, see the summary later in this section, plus [Changing Settings with Device Manager](#).
- You can use the Display and Mouse options in Control Panel to install and configure all device driver and user preference settings related to the display and pointing devices. For information, see the summary later in this section, plus [Configuring the Display](#) and [Configuring the Mouse](#).

For other devices, Windows 95 provides installation and configuration wizards. For example, you use wizards to install modems, faxes, printers, multimedia, and sound devices. For information about using these specific tools, see related chapters in the *Windows 95 Resource Kit*.

This section summarizes improvements in support for display adapters, pointing devices, and communications ports.

Improved display adapter and monitor support.

Windows 95 Setup automatically detects the display adapter and installs the appropriate display driver. The Windows 95 display drivers are stringently tested to ensure greater reliability and stability than drivers for Windows 3.1.

Also, Windows 95 includes mechanisms to ensure that bad or incompatible display drivers cannot keep you from starting and using the system. If a display driver fails to load or initialize when Windows 95 is started, Windows 95 uses the generic VGA display driver. Benefits of the new display driver support in Windows 95 include the following:

- More stable and reliable display adapter drivers using the mini-driver architecture, with support for many more display adapters
- Support for new features, including the ability to change display resolution without needing to restart Windows 95
- Display driver support for mobile computing, providing functionality to switch automatically between display adapters in a portable computer and a docking station
- Consolidated installation and configuration of display drivers and display properties such as colors, wallpaper patterns, and screen savers in a single Control Panel icon
- Image Color Matching (ICM) support for device-independent color usage (offered through an agreement between Microsoft and Kodak)
- Support for a new generation of hardware and device functionality, such as Energy Star Monitors conforming to the VESA Display Power Management Signaling (DPMS) specification, and detection of monitor properties such as maximum resolution supported when used in conjunction with monitors that support the VESA Display Data Channel (DDC) specification

Windows 95 includes drivers for nearly all popular graphics accelerators, and has been shown to run faster than Windows 3.1 on the following models and chip sets:

ATI Technologies Inc.	COMPAQ QVision	Tseng Labs
Cirrus Logic	IBM XGA	Western Digital
Chips & Technologies	Matrox MGA	

The graphics accelerators in the preceding list are installed on numerous computers and retail graphics adapters and sold under many different make and model names. Before purchasing a new computer or graphics accelerator card, we recommend that you know what graphics accelerator it uses and whether it is supported by Windows 95 drivers developed by Microsoft or another manufacturer. Other accelerator and adapter manufacturers not included in this list will have drivers available.

Improved mouse and pointing device support.

As with other device drivers, the mini-driver architecture of Windows 95 simplifies mouse driver development and improves virtualization in a protected-mode mouse driver to better support MS-DOS-based applications in the Windows environment. Windows 95 includes the following improvements to mouse support over Windows 3.1:

- Smooth, reliable input support through the use of protected-mode drivers
- Easy installation for mouse and pointing devices, including Plug and Play support
- A single mouse driver, eliminating the need to use separate mouse drivers for MS-DOS and Windows, which increases robustness and saves conventional memory
- Support for connecting a mouse after Windows 95 has started — to assist mobile computer users who forget to connect a mouse before turning on the computer
- Consolidated mouse configuration and customization support in a single Control Panel option
- Improved device support to allow the use of serial ports COM1 through COM4 for connecting a mouse or other pointing device

Improved communications hardware support.

Windows 95 provides improved communications device and hardware support over Windows 3.1. A few areas of improvement include the following:

- 16550A UART FIFO support. Windows 95 provides robust, high-quality performance at high speeds for MS-DOS based and Windows-based communications applications using local serial ports with 16550A compatible UARTs. Communications support in Windows 95 alleviates the need for communications driver replacements to improve performance.
- More ports supported. The Windows 95 communication APIs support the same number of logical ports as MS-DOS: 128 serial ports and 128 parallel ports. This enhanced limit allows use of multiport serial devices. The actual limitation on the number of ports usable is still based on the physical number of ports available to the computer.
- Support for parallel port modems. Additionally, Windows 95 provides support for enhanced capabilities port (ECP) printers and future ECP-based high-speed parallel devices.

Improved power management support.

Microsoft worked with Intel to develop an industry standard for Advanced Power Management (APM). Now most major computer manufacturers of both portable and desktop computers widely support the APM specification. Windows 95 includes an APM driver that sends messages to the computer's BIOS to manage such things as conserving power during idle periods, reducing monitor power consumption, and processing suspend and resume requests on computers with such features. For information about enabling APM if it was disabled during Setup, see [Troubleshooting Device Configuration](#).

Devices: The Issues

For information related to the specific devices you are responsible for administering, check the lists of supported hardware in the Add New Hardware wizard and the README.TXT file provided with Windows 95.

If you try to install device drivers that were created to run in 32-bit mode in Windows 3.x, you can damage your Windows 95 configuration, because these particular drivers add VxD information to the SYSTEM.INI file. If the device is supported under Windows 95, the best way to recover and install the device is to do the following.



To recover from faulty installation of a Windows 3.x driver

1. Restart the computer. Press F8 when the Starting Windows 95 message appears, and then choose the Safe Mode option.
2. Remove all entries added to SYSTEM.INI by the Windows 3.x driver installation program.
3. Remove the device in Device Manager, as described in [Changing Settings with Device Manager](#).
4. Shut down and restart Windows 95.
5. In Control Panel, double-click the Add New Hardware icon to reinstall the device using real-mode drivers. To install real-mode drivers, you must choose to manually select the hardware you want to install, and then provide the path name to the real-mode drivers. The device will function correctly, but will not be operating in 32-bit mode.

Also, contact the device manufacturer to determine when drivers compatible with Windows 95 will be available.

Devices Overview

In Windows 95, how you install a device depends on whether the device and the computer are Plug and Play-compliant. To take full advantage of Plug and Play technology, a computer needs the following:

- Plug and Play operating system (Windows 95)
- Plug and Play BIOS
- Plug and Play-compliant hardware devices with drivers

The Plug and Play components perform the following tasks:

- Identify the installed devices
- Determine the device resource requirements
- Create a nonconflicting system configuration
- Program the devices
- Load the device drivers
- Notify the system of a configuration change

Windows 95 handles the installation and configuration of Plug and Play-compliant devices automatically, and it provides a wizard to detect and configure legacy devices. Microsoft recommends that, whenever possible, you choose new Plug and Play-compliant devices, even for a legacy computer which does not have a Plug and Play BIOS.

Windows 95 uses a large number of subsystems to control various classes of devices that identify logical device types such as the display, keyboard, and network. Each subsystem uses a different driver architecture and offers different user options and compatibility constraints, so different installation mechanisms are required for each class. For many devices, you must use Device Manager in the System option in Control Panel for configuration if you need to make manual changes.

The following table lists the default classes and shows where you can find the installation tools for changing the device driver.

Class and device types	Where to configure this device
Disk class: Disk drives and adapters	Properties for specific devices displayed under related disk controllers in Device Manager.
Display class: Display adapters	Display option in Control Panel. See Configuring the Display .
Keyboard class: Keyboard devices	Keyboard option in Control Panel. See online Help.
Modem class: Data and fax modems	Modem option in Control Panel. See Modems and Communications Tools .
Mouse class: Mouse devices	Mouse option in Control Panel. See online Help. See also Configuring the Mouse .
Multimedia class: Multimedia devices	Multimedia option in Control Panel. See the related media devices in Device Manager for game ports; see also Multimedia .
Network class: Network adapters	Properties for the network adapter under the Network option in Control Panel. See Network Technical Discussion .
PCMCIA class: PC Card sockets	Specific device's properties in Device Manager. See Enabling PCMCIA Cards .
Ports class: Ports	Ports properties in Device Manager. See Configuring Communications Ports and Printer Ports .

Printer class: Printers Folder (no class installer). See [Printing and Fonts](#).
Printers
System class: Installation handled by the system. Configure using the device's properties in Device Manager.
System devices
Unknown class: Add New Hardware icon in Control Panel. See [Installing New Devices](#).
Detected devices with no driver for Windows
95

How Windows 95 Installs a New Device: An Overview

Windows 95 Setup performs an inventory of all devices on the computer and records the information about those devices in the Registry. Setup gets configuration information from device INF files. To maintain compatibility, Setup also checks entries in WINI.INI, SYSTEM.INI, and CONFIG.SYS.

When a new device is installed, Windows 95 uses the device ID to search Windows 95 INF files for an entry for that device. Windows 95 uses this information or a default driver to create an entry for the device under the Hkey_Local_Machine branch in the Registry, and it copies the drivers needed. Then the Registry entries are copied from the INF file to the driver's Registry entry, including the **DevLoader=** and **DriverDesc=** values for the Driver entry, and the **Driver=** and **ConfigFlags=** values for the Enum entry.

Tip If you use custom setup scripts to install Windows 95, you can include the setting **devicepath=1** in the [Setup] section to specify that Windows 95 should check a source installation path to find INF files, rather than looking only in the Windows INF directory when installing devices. When you use this parameter in setup scripts, you can later add INF files to a single network source location to ensure that up-to-date drivers are used any time a new device is installed on computers running Windows 95. For information, see [MSBATCH.INF Parameters](#).

Installing New Devices

When you need to install a new device, you should first rely on Windows 95 to detect and configure it. For Plug and Play-compliant devices, this means inserting the device into the computer. For legacy devices, this means running the Add New Hardware wizard.

Note Before you install a new device, check the Modems section in the Windows 95 README.TXT file for possible information.



To install a new Plug and Play-compliant device

1. Insert the device.

Whether you need to turn off the power before inserting the device depends on the type of device. Check the documentation for your new device.

2. Windows 95 notifies you that it has identified a new card. If no driver is provided on the system, it asks you to insert a disk that contains a driver that was developed for Windows 95.
3. For PCMCIA cards, after Windows 95 identifies and loads the appropriate driver, the computer emits a beeps when the new device is configured.

You can begin working with the device immediately. Windows 95 notifies other drivers and applications that the device is available.

If your computer uses PCMCIA cards or other Plug and Play cards and if a driver is not available for the new device, Windows 95 prompts you for a driver file to install. If Windows 95 detects the presence of a new device — either during Setup, device installation, or startup — but does not have a driver, it automatically asks for a disk that can be used to install and configure a driver.



To install a legacy device



1. In Control Panel, double-click the Add New Hardware option.
2. In the Add New Hardware wizard, click Next, and then click the option named Automatically Detect Installed Hardware.

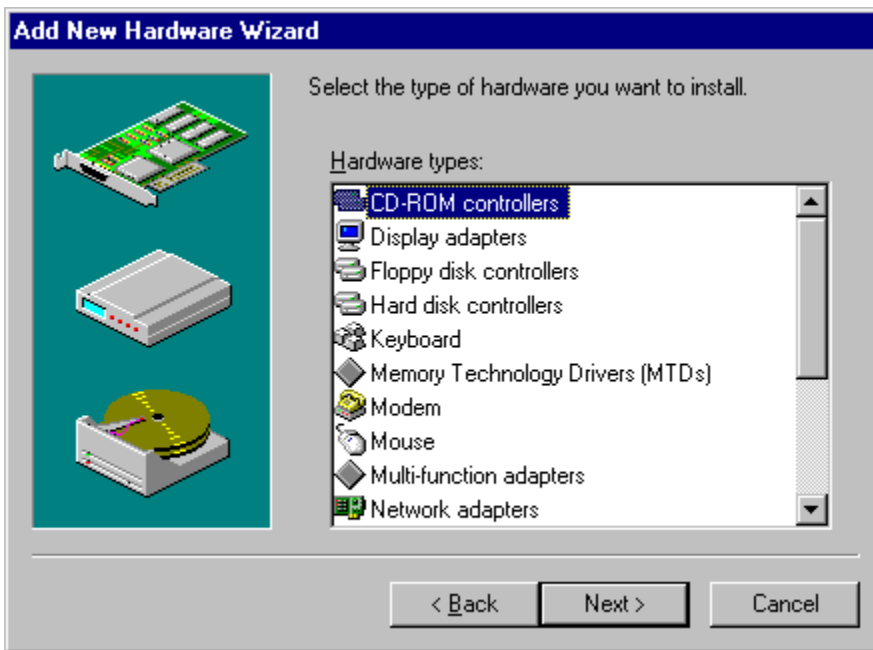

3. Continue to follow the instructions on the screen to install drivers and to configure the device driver.

If Windows 95 does not have a driver for the device, you can install the driver from a disk by using the Add New Hardware wizard.



To install a legacy device from a disk by using the Add New Hardware wizard

1. In the Add New Hardware wizard, click Next, and then click Install Specific Hardware.
2. In the list of hardware devices, click a device class, and then click Next.
3. In the next Add New Hardware dialog box, specify the manufacturer and model of the device, and then click Have Disk.
4. In the Install From Disk dialog box, type the path name to the driver files, and then click OK.

Changing Settings with Device Manager

For Plug and Play-compliant devices, there are no true default settings. Instead, Windows 95 identifies devices and their resource requests, and then arbitrates requests among them. If no other device requests the same resources as another device, its settings should not change. If another device requests its resources, the settings might change to accommodate the request. Consequently, you should never change resource settings for a Plug and Play-compliant device unless absolutely necessary. Doing so will fix its settings, making it impossible for Windows 95 to grant another device's request to use that resource.

All legacy devices have fixed resource settings, which are defined either during Windows Setup from a previous configuration, or afterward in the Add New Hardware wizard in Control Panel.

Certain circumstances might require users to change resource settings after they have been configured. For example, Windows 95 might not be able to configure one device without creating conflicts with another device. In such a case, a message usually appears to explain what is happening and what you can do about the problem — turn off a device to make room for the new device, disable the new device, or reconfigure a legacy device to make room for the new device.

The best place for resolving any conflicts that might occur is the Hardware Conflict troubleshooting aid in Windows 95 online Help. For more information, see [Troubleshooting Device Configuration](#).

When you must manually change a device's configuration, you can use Device Manager in the System option in Control Panel. Using Device Manager helps you avoid the errors that can occur if you attempt to edit Registry entries directly.

If you need or want to resolve device conflicts manually, you can use Device Manager and try the following strategies:

- Identify a free resource, and assign the device to use that resource.
- Disable a conflicting Plug and Play-compliant device to free its resources.
- Disable a legacy device by removing the legacy device card and not loading the device drivers.
- Rearrange resources used by another device or other devices to free resources needed by the device with a conflict.
- Change jumpers on your hardware to match the new settings.

Caution Changing default settings using either Device Manager or Registry Editor can cause conflicts that make one or more devices unavailable on the system.

Device Manager and Registry Editor are provided as configuration tools for advanced users who understand configuration parameters and the ramifications of changing settings.



To use Device Manager



1. In the System option in Control Panel, click the Device Manager tab.
– Or –
Right-click My Computer, click Properties from the context menu, and then click the Device Manager tab.

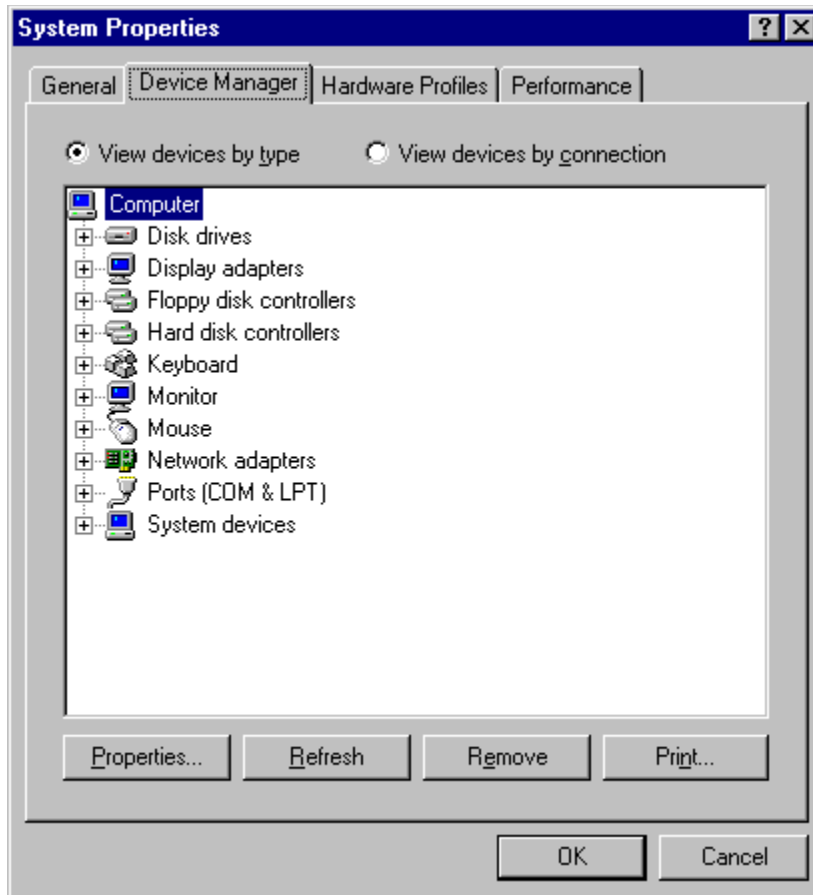

2. Double-click the device type in the list to display the specific devices of that type on your computer.
3. Double-click the device you want to configure. Or select the device, and then click the Properties button to view or change its settings.



To change the device driver using Device Manager

1. In Device Manager, double-click the related device type.
2. Double-click your current device to display its properties.
3. Click the Driver tab.

The Driver properties dialog box shows the driver files and current resource setup for that device.

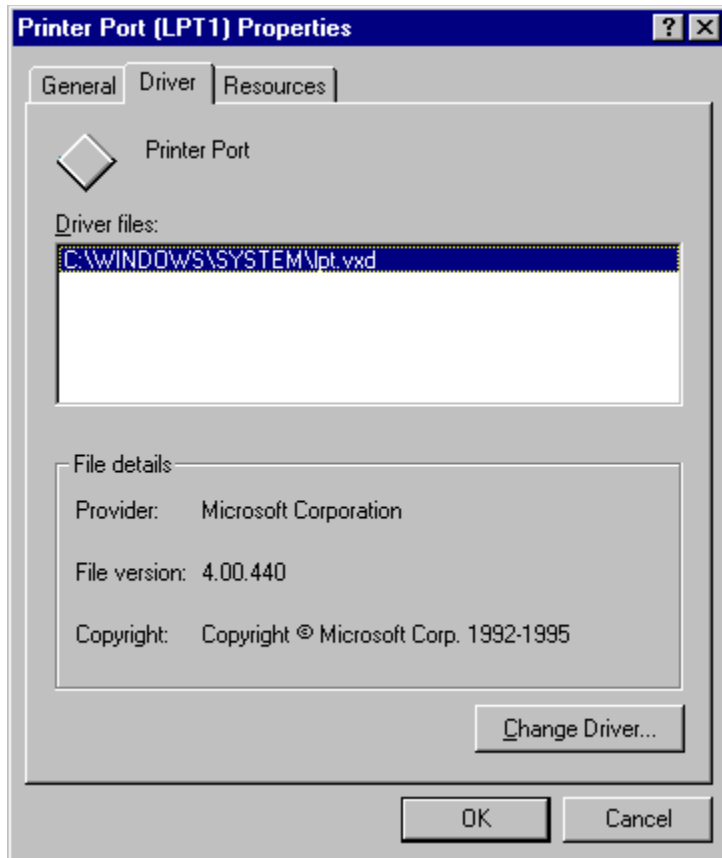

4. Click the Change Driver button.

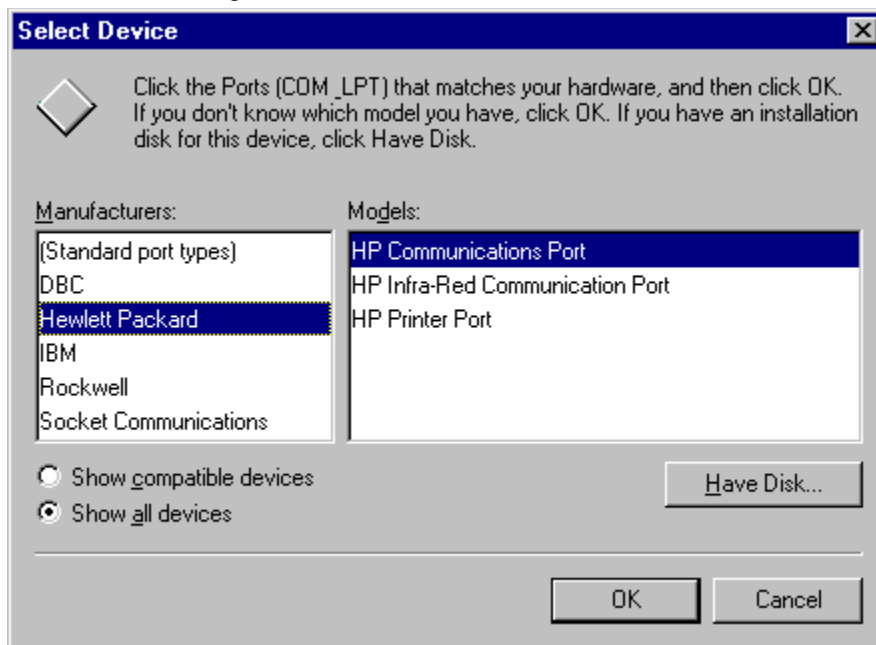

5. In the Select Device dialog box, the Show Compatible Devices option is checked to show you a list of drivers that Windows 95 has identified as compatible for your device.

– Or –

Click Show All Devices to see a list of all the drivers available in Windows 95.

Important Be very careful in selecting a driver in the Show All Devices list. You should select a driver from the Show All Devices list only when you know that you are selecting a driver that is compatible with the device.

6. In the Models list, select the driver you want to use, and then click OK.
7. If requested, follow the instructions on the screen to provide a disk or a path to a directory that contains the display driver.

In Device Manager, you can print reports about system settings, including reports on the following:

- System summary
- Selected class or device
- All devices and system summary



To print a report about system settings

1. In Device Manager, click Print.
2. In the Print dialog box, click the type of report you want.

Caution You should quit all MS-DOS-based applications before printing the report named All Devices And System Summary because the device detection code might cause problems for some MS-DOS-based applications. If you do not do this, some applications might report the system is out of memory.



To change a device's resource settings using Device Manager

1. In Device Manager, double-click a device class.
The tree expands to show the devices of that class available on the computer.
2. Double-click a device to display its properties.
3. In the device's properties, click the Resources tab.

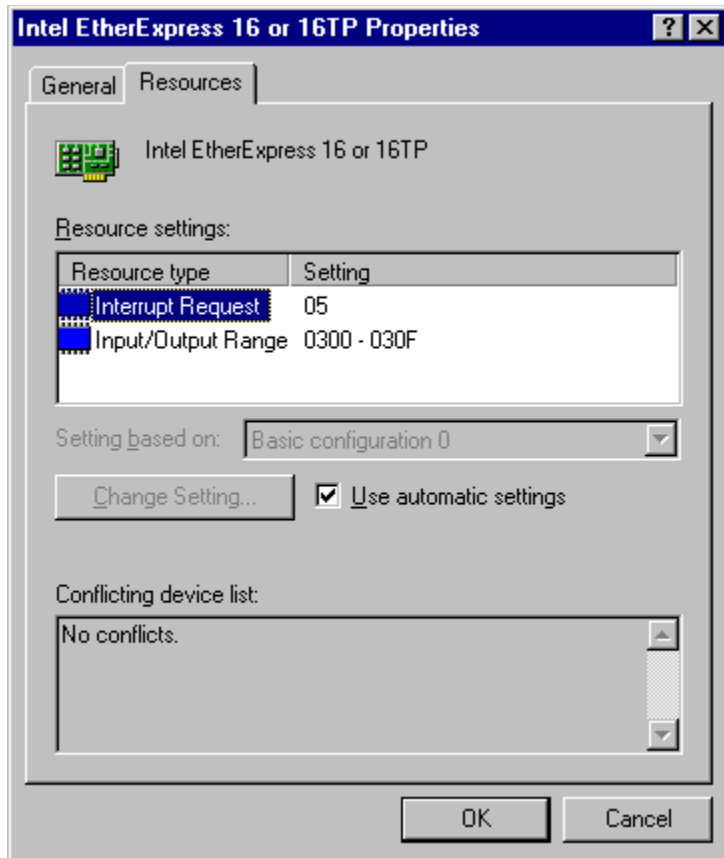

Notice that the Conflicting Devices List shows any conflicting values for resources used by other devices.

4. In the Resource Type list, select the setting you want to change — for example, the Input/Output Range — and then click the Change Setting button.

Notice that you can select and set the IRQ, I/O, and DMA independently, and that if the option named Use Automatic Settings is checked, you cannot change resource settings.

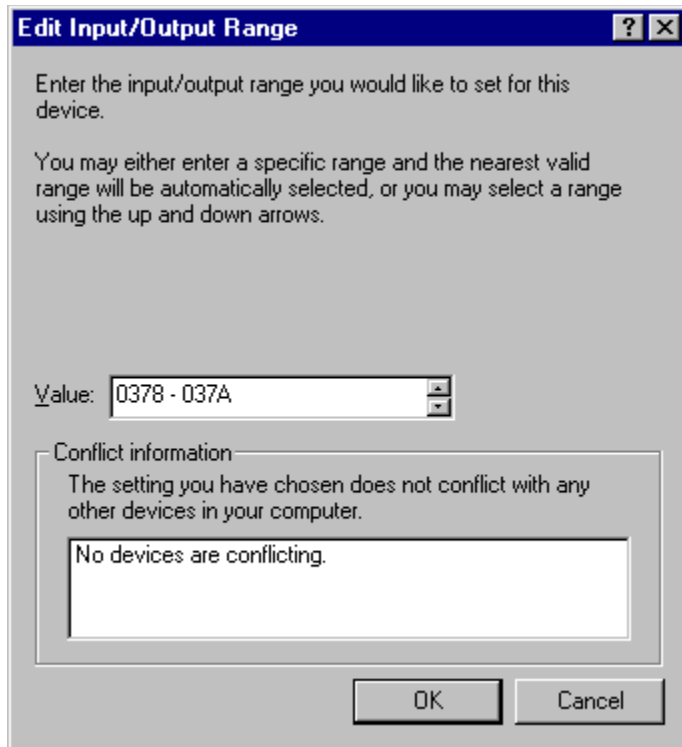

The dialog box shows the various settings that the device supports. Notice that in the Edit Input/Output Range box any interrupt marked with an asterisk (*) will conflict with an existing device. Any interrupt marked with a pound sign (#) indicates that the actual configuration has been tested.

When you clicked the Change Setting button, you might have received an error message saying "This resource setting cannot be modified." If this is the case, you must choose a different basic configuration until you find one that allows you to change resource settings.

5. Choose a setting that does not conflict with any other devices, and then click OK.
6. Shut down and restart Windows 95. Then verify that the settings are correct for the device.

Note Most legacy devices have jumpers or switches that set the IRQ, DMA, and I/O addresses. If you change these settings in Device Manager, you must also change the settings on the device to match them.

Tips for Changing Settings with Registry Editor

You can use Registry Editor to change specific values for devices. Use Registry Editor to change system settings in the following cases:

- When directed to make specific changes by a product support representative.
- When you know the correct Registry key, value settings, and editing restrictions for a specific device.
- When you cannot successfully change the value using Device Manager or other built-in tools.

When you make changes in Registry Editor, always make one change at a time, and then test the system for the results. If you have problems with the system after making a change, restart the computer and press F8 when the Starting Windows 95 message appears, and then choose the Safe Mode option. Then you can change the setting back to its previous value.

You can also use the Connect command in Registry Editor to connect to and view the Registry on a remote computer if that computer has the

Microsoft Remote Registry service installed. For information about using Registry Editor, see [Windows 95 Registry](#).

Devices

Enabling PCMCIA Cards

To enable Windows 95 Plug and Play support for the PCMCIA socket, you must run the PCMCIA wizard. The PCMCIA wizard comments out the real-mode drivers in the AUTOEXEC.BAT and CONFIG.SYS files and enables the PCMCIA socket. In some cases, Windows 95 disables Plug and Play PCMCIA support if there is a risk of incompatibility.

If you must use old drivers, Windows 95 should work well with your previous PCMCIA drivers, although some Plug and Play capabilities such as automatic installation and friendly device names will not be available.

Windows 95 supports many PCMCIA cards including modems, network adapters, SCSI cards, and others. If Windows 95 includes supporting drivers for the PCMCIA card and for the socket, then installation and configuration should be automatic. This section provides some guidelines for enabling Windows 95 enhanced PCMCIA support when automatic detection and configuration aren't available for your card.

If your PCMCIA card is not shown in the list of manufacturers and models in the Add New Hardware wizard, contact the vendor and request a Windows 95-compatible installation disk before enabling the Windows 95 enhanced PCMCIA support. Also, see these Help topics:

- "Setting Up Other Hardware," if you added a PCMCIA socket after setting up Windows 95
- "If You Have Trouble Using a PCMCIA Card"

Important Your PCMCIA socket driver and network driver both must be Plug and Play-compliant drivers (that is, developed for Windows 95 and NDIS 3.1-compliant) or both must be real-mode drivers. If these drivers are of mixed types, the computer might stall or the network might not work.

Windows 95 Setup automatically detects the presence of a PCMCIA socket, but to enable it, you must run the PCMCIA wizard.



To verify that Windows 95 has properly detected your PCMCIA socket

1. In the System option in Control Panel, click the Device Manager tab.
2. Look for a PCMCIA Socket listing.

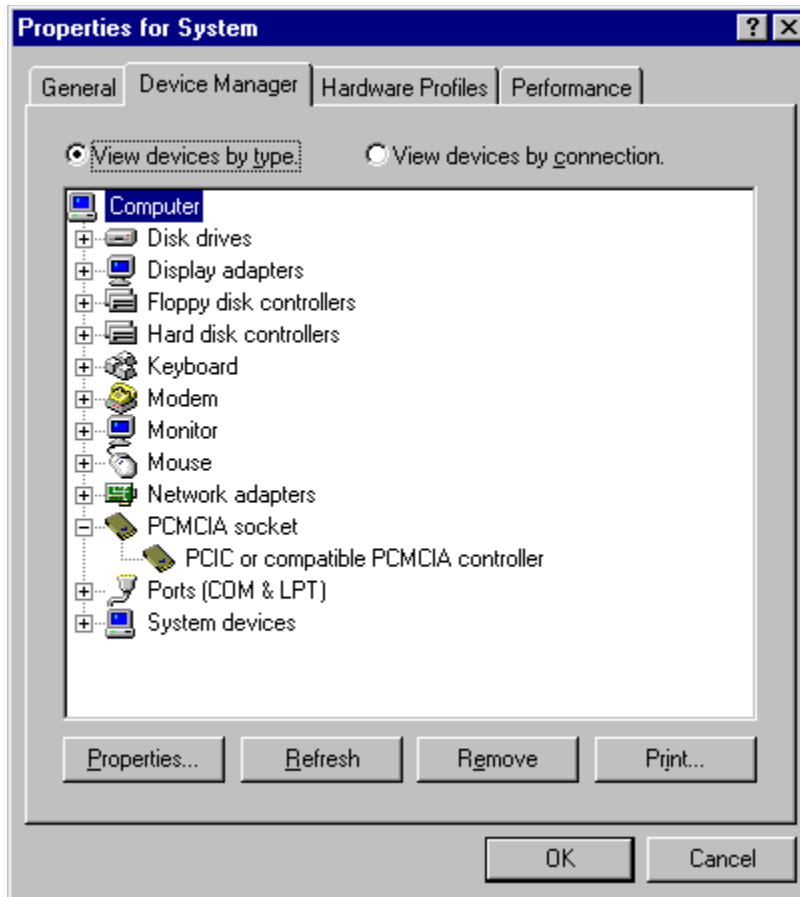

If Windows 95 has not detected a PCMCIA socket, your socket controller might not be supported by Windows 95.



To find out if a PCMCIA socket is supported

1. In Control Panel, double-click the Add New Hardware icon.
2. On the first screen in the Add New Hardware wizard, click the Next button, and then click Install Specific Hardware.
3. In the Hardware Types list, select PCMCIA Socket, and then click the Next button.
4. Select the manufacturer for your device, and examine the Models list.
If your socket does not appear in the list, you should contact the manufacturer to see if new drivers are available.



To enable support for PCMCIA by running the PCMCIA wizard

- In Control Panel, double-click the PCMCIA icon.
 - Or –
Double-click the PCMCIA controller in the Device Manager.
 - Or –
Look up the topic named “PCMCIA” and then look up “Enable Support For” in the Windows 95 Help Index.



To find out if Windows 95 has activated enhanced PCMCIA support

1. In Device Manager, click your PCMCIA controller, and then click the Properties button.
2. Click the General tab.

If a hardware profile in the Device Usage box is checked, then PCMCIA support is enabled.

If you have the correct drivers and enhanced PCMCIA support is activated, but the device is still not available, your computer is probably using the wrong memory window for the device. Windows 95 selects a default set of commonly supported settings. Your socket might not support certain interrupt settings, so you might be able to get a PCMCIA socket to work by changing the IRQ. Similarly, your socket might not work on certain memory windows, and changing the memory window might solve your problem.



To change the memory window for a PCMCIA device

1. In Device Manager, click your PCMCIA socket, and then click the Properties button.
2. In the PCMCIA controller properties, click the Global Settings tab.
3. Make sure that the Automatic Selection check box is not checked.
4. Change the Start address based on information from your hardware manual.
Typically, selecting a Start value higher than 100000 will work.
5. Restart Windows 95.



To change the interrupt for a PCMCIA device

1. In Device Manager, click your PCMCIA socket, and then click the Properties button.
2. Change the IRQ from its default to a value that doesn't conflict with other IRQ settings used on your computer.
3. Restart Windows 95.

If Windows 95 still doesn't detect your PCMCIA cards, you should disable the Windows 95 enhanced PCMCIA support.



To disable the enhanced PCMCIA support

1. In Device Manager, click your PCMCIA controller, and then click the Properties button.
2. Click the General tab, and in the Device Usage box, click to clear the check beside the hardware profile.

Using Hardware Profiles for Alternate Configurations

Windows 95 uses hardware profiles to determine which drivers to load when the system hardware changes. When you start Windows 95, Windows 95 runs detection to see if any hardware on the computer has changed. If the hardware has changed significantly, Windows 95 creates a new hardware profile and prompts you for a name. If you move the computer to a new site and use a different configuration, Windows 95 notices it when you start the computer and loads the appropriate drivers.

The only time Windows 95 prompts you for the name of a hardware profile is when two profiles are so similar that Windows 95 can't differentiate between them. If this happens, Windows 95 displays a Hardware Profile menu from which you can choose the correct one.

Hardware profiles are an especially important feature for portable computers that can be docked. Windows 95 uses one hardware profile to load drivers when the portable is docked, and another profile when the portable is undocked — for example, at a customer site that has a different monitor than at the office.

Note It is not necessary to use a different hardware profile for a Plug and Play portable computer, because the computer automatically knows when it is docked or undocked.



To create a hardware profile

1. In the System option in Control Panel, click the Hardware Profiles tab.
2. Click the name of the hardware profile you want to base the new hardware profile on, and then click Copy.
3. Type a name for the hardware profile you are creating.
4. Change which hardware is enabled or disabled in this profile by using the Device Manager, as described in the following procedure.

Tip If you have a hardware profile with the same name as a Windows 95 Startup Menu item, the corresponding menu item will be run automatically when you use that hardware profile for system startup.



To enable or disable hardware in a hardware profile

1. In Device Manager, click the plus sign next to the hardware type, and then double-click the hardware.
2. In the Device Usage box, click to place a check mark next to each hardware profile in which you want to enable the hardware, or clear the check box to disable the hardware for that hardware profile.
3. If you see a message prompting you to restart your computer, click Yes.



To delete or rename a hardware profile

1. In the System option in Control Panel, click the Hardware Profiles tab.
2. Click the name of the hardware profile you want to change.
3. If you want to remove this profile, click Delete.

-Or -

If you want to change the name of the profile, click Rename, and then type a new name.

Configurations are created when Windows 95 queries the BIOS for a dock serial ID and then assigns a name for the docked and undocked configuration. Windows 95 then stores the hardware and software associated with this configuration. Applications access and store information for each of the different hardware configurations used by the mobile user. The Registry support enables applications to adapt gracefully to different hardware configurations.

Tip If you are running Multiconfig, you can name a hardware profile the same as a Multiconfig menu option. In this case, Windows 95 detects a hardware profile and automatically runs the

corresponding Multiconfig menu option. You can create this by specifying identical names for the Multiconfig menu option and the hardware profile.

Configuring the Display

Windows 95 consolidates display properties in the Display option in Control Panel, so you can easily customize display adapter settings. You can use the Display option in Control Panel to do the following:

- Change the display type or driver.
- Change screen resolution and color palette (without restarting the computer when using display drivers that support this functionality).
- Change color schemes and text styles in all screen elements, including changing fonts used in dialog boxes, menus, and title bars.
- View changes in colors, text, and other elements of display appearance before the changes are applied.
- Configure display settings for each hardware profile; for example, docked and undocked configurations.

Tip To set display options quickly, right-click the desktop, and then click Properties. Click the Help icon to get Help for setting display properties.

Display Driver Overview

Windows 95 provides enhanced functionality and easy configuration for display adapters, in addition to resolving many problems inherent in Windows 3.1 display drivers. By using a mini-driver architecture for display drivers, Windows 95 provides better support for a wide range of hardware and provides more stable and reliable drivers.

Windows 95 Setup automatically detects the display adapter in the computer and installs the correct display driver, upgrading to a new driver if a new version is available.

Windows 95 contains a universal display driver called the device independent bitmap (DIB) engine. The DIB engine provides 32-bit graphics code for fast, robust drawing on high-resolution and frame buffer-type display adapters. Windows 95 display mini-drivers use the DIB engine for all in-memory graphics operations and on-screen operations that do not pass to the adapter for hardware acceleration. This architecture makes it easy for hardware developers to write drivers for a new controller type and to add hardware acceleration features incrementally.

To ensure broad support for display adapter devices in Windows 95, Microsoft developed many of the display drivers in cooperation with the major display-controller hardware manufacturers. The Microsoft development team also worked closely with hardware manufacturers to write additional display drivers and assisted in optimizing drivers to enhance display speed for improved graphic performance.

Windows 95 also includes mechanisms to ensure that incompatible display drivers cannot prevent a user from accessing the system. If a display driver fails to load or initialize when Windows 95 is started, Windows 95 automatically uses the generic VGA display driver. This ensures that you can start Windows 95 to fix a display-related problem.

For displays, colors are described in bits per pixel (bpp). The following table lists the bpp-to-colors conversion.

Bits per pixel	Color conversion
1 bpp	Monochrome
4 bpp	16 colors
8 bpp	256 colors
15 bpp	32,768 (32K) colors
16 bpp	65,536 (64K) colors
24 bpp	16.7 million (16.7M) colors
32 bpp	16.7 million colors

Resolutions are described in horizontal number of pixels multiplied by (x) vertical number of pixels — for example, 640x480.

Changing the Display Type and Driver

You can change a display driver by using the Display option in Control Panel or by using Device Manager. For more information about adding or changing a device driver, see online Help.

Caution Some monitors can be physically damaged by incorrect display settings. Carefully check the manual for your monitor before choosing a new setting.

To change the display driver by using the Display option in Control Panel

1. In Control Panel, double-click the Display icon.

– Or –

Right-click the desktop, and then click Properties from the context menu.

2. In the Display Properties dialog box, click the Settings tab.

3. In the Display Settings dialog box, click the Change Display Type button, and then click the Change button.

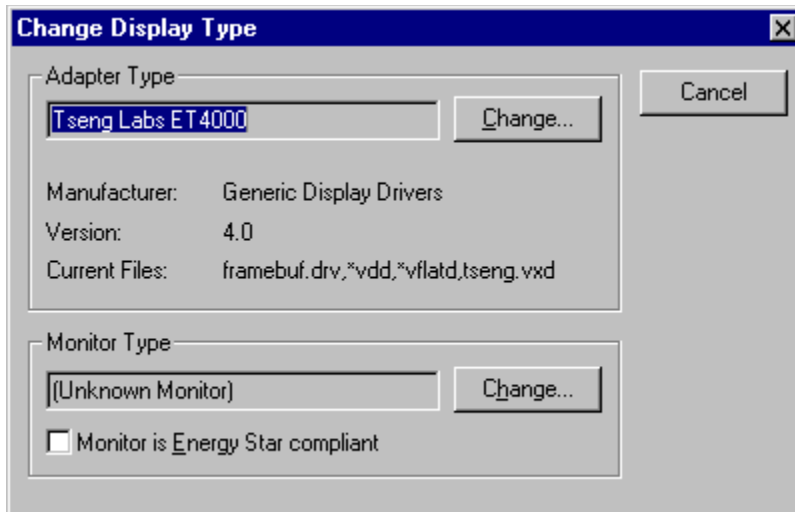

4. In the Select Device dialog box, click the Show Compatible Devices option to see a list of drivers that are compatible with the display adapter.

Or

Click Show All Devices to see a list of all the display drivers available in Windows 95.

Important You can safely select any driver in the Show Compatible Devices list in the Select Driver dialog box. Select the Show All Devices option only if you know that you need to select a driver from the Models list that also supports your display. You must be careful to select a driver that you know to be compatible with your display adapter.

5. In the Models list, click the driver you want to use, and then click OK.

If prompted, follow the instructions on your screen to provide a disk or path to a directory that contains the display driver.

Tip The [boot] section of the SYSTEM.INI file should contain the following line for any Windows 95 version of a display driver:

```
display.driv=pnpdrv.rdrv.
```

The actual display driver is loaded from the Registry. This supports docking computers that have different adapters for the portable computer versus the docking station.

For display drivers that do not appear in the Select Device dialog box (that is, those that are not provided with Windows 95), the Windows Driver Library (WDL) provides support for drivers from other vendors. For information about the WDL, see [Windows 95 Resource Directory](#).

You can also install Windows 3.x display drivers, if required. However, Microsoft strongly recommends that you upgrade to Windows 95 display drivers so you can take advantage of the Windows 95-specific display drivers that provide new features and functionality. For example, many display adapters and drivers support Plug and Play detection and “on the fly” resolution changes; these features are not supported by Windows 3.1 drivers.



To install Windows 3.1 display drivers

1. In the Display option in Control Panel, click the Settings tab, and then click Change Display Type.
2. Click the Change button next to Adapter Type, and then click the Have Disk button.
3. Specify the path to the disk or directory containing the Windows 3.1 drivers you want to use.
4. Select the correct driver to use from the list that appears, and then click OK to install.

When Show All Devices is selected in the Select Device dialog box, old drivers appear in the Select Device dialog under the manufacturer type Windows 3.x Drivers.

Notice that some Windows 3.1 drivers require the screen resolution to be specified in the [boot.description] section of SYSTEM.INI. For example:

```
display.driv=Acme Inc. 640x480 256 colors
```

Devices

Configuring the Display

Configuring Display Resolution and Color Palette

You can configure the display resolution and color palette choices for your display or customize the font size used by using the Display option in Control Panel.

After making these kinds of changes, you must shut down and restart the computer unless you are using a Plug and Play-compliant display adapter and driver that support on-the-fly changes.

To configure your display resolution

1. In the Display option in Control Panel, click the Settings tab.

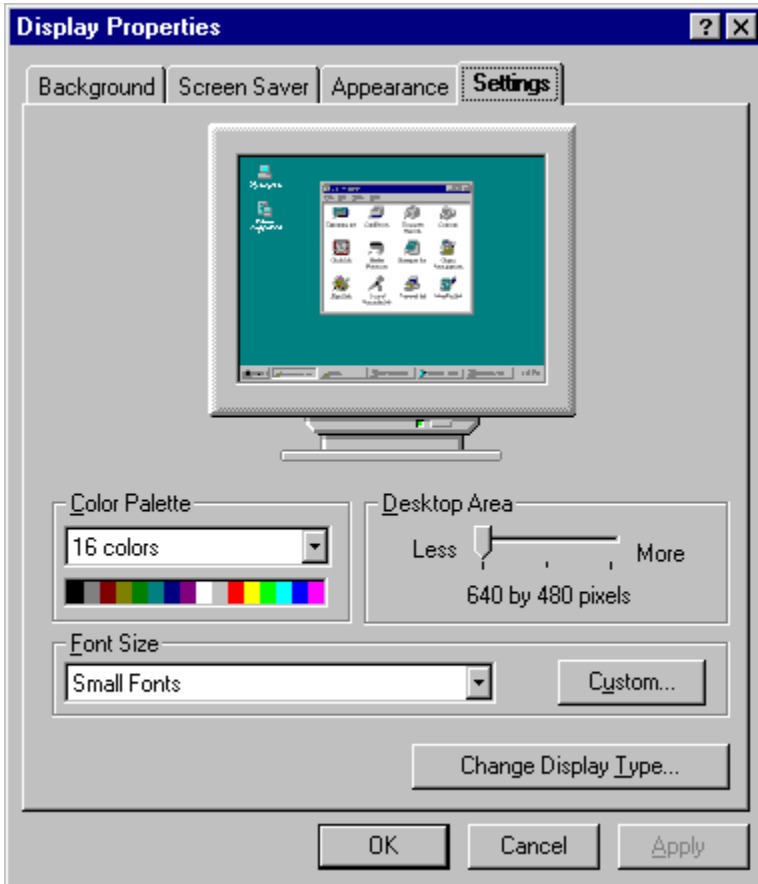

2. In Display properties, use the options described in the following table to change your display settings.

Option	Description
Color Palette	Select from this list the number of colors you want for your display adapter. The larger the number, the greater the number of colors.
Desktop Area	Drag the slider to change the visible screen area used by the display. The larger the desktop area, the smaller everything looks on your screen.
Font Size	Select from this list one of the font sizes for your display type. Typically, the selections will be Small Fonts and Large Fonts. To set the font used in dialog boxes, see Configuring Display Appearance .

- Custom Click to change the size of the text that Windows 95 displays, as described in the following procedure.
- Change Display Type Click to display a dialog box for selecting another adapter type or monitor type. Notice that the monitor type setting has no impact on system performance. This setting identifies the characteristics of the monitor in order to define the maximum resolution and power management capabilities that it supports. For information, see [Changing the Display Type and Driver](#).

Note Sometimes a larger number of colors requires you to have a smaller desktop area, and vice versa. This is due to a limitation of the display adapter. Extra large sizes might adversely affect the display in some applications.



To customize display of fonts in dialog boxes

1. In the Display option in Control Panel, click the Settings tab, and then click the Custom button.

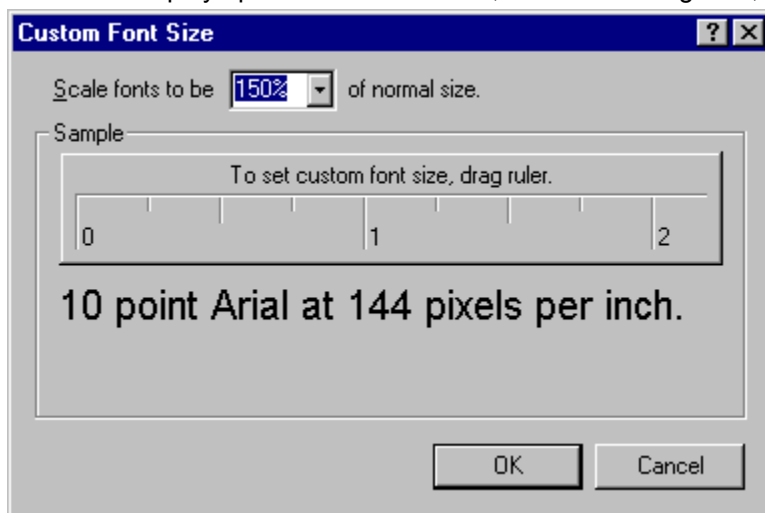

2. Drag the controls until the sample shows the size you want, and then click OK.
For non-Plug and Play devices, you must shut down and restart Windows 95 for the changes to take effect.

Setting the monitor type in the Display properties sheet does not affect the refresh rate output of your display adapter. To change this, you must run a utility supplied by your display adapter manufacturer or computer manufacturer. Some display utilities must be run in the AUTOEXEC.BAT file; however, on other computers, display type is set in BIOS configuration programs. Some examples of such utilities are described in the following list.

Adapter	Manufacturer's display utility
ATI	INSTALL.EXE
Cirrus Logic	MONTYPE.EXE, CLMODE.EXE, WINMODE.EXE
Diamond Stealth	STLMODE.EXE
Diamond Stealth 64	S64MODE.EXE
Matrox	\MGA\SETUP\SETUP.EXE
Tseng Labs	VMODE.EXE
Western Digital	VGAMODE.EXE

Configuring Display Appearance

You can use the Display option in Control Panel to set the screen saver and the background pattern used on the desktop. (These options replace Desktop options in the Windows 3.x Control Panel.)

You can also use settings in Screen Saver properties to take advantage of Energy Star Monitor support in Windows 95 if your hardware supports this feature. This is similar to the standby mode commonly used in portable computers to save power. Windows 95 can support screen saver power management if both of the following conditions are true for your computer:

- In the Change Display Type dialog box, the option named Monitor Is Energy Star Compliant is checked.

This option is checked automatically if, during Setup, hardware detection determined that the monitor supports the VESA DPMS specification. You can also check this option manually.

- The device driver for this display uses either the Advanced Power Management (APM) 1.1 BIOS interface with support for device "01FF" (which is not supported by every APM 1.1 BIOS), or the VESA BIOS Extensions for Power Management. For information about whether your display adapter supports these BIOS interfaces, see the documentation for your device driver.

The display monitor is typically one of the most "power hungry" components of a computer. Manufacturers of newer display monitors have incorporated energy-saving features into their monitors based on the VESA Display Power Management Signaling (DPMS) specification. Through signals from the display adapter, a software control can place the monitor in standby mode or even turn it off completely, thus reducing the power the monitor uses when inactive. To do this, Windows 95 extends the screen saver capabilities to provide both a time-delay setting that allows the user to put the display monitor in a low-power standby mode, and a delay setting to turn the monitor off completely.

If your computer can use Energy Star power consumption features, additional options appear in Screen Saver properties. To take advantage of these features, both the display adapter and monitor must meet the Energy Star specifications. Also, the display driver must support the extensions needed to control the monitor. Several hardware providers currently manufacture monitors designed to support the Energy Star goals.



To use Energy Star power consumption features

- In Display properties, click the Screen Saver tab and specify the time intervals for when to use low-power standby and when to shut off power.

For example, you might want to set these options:

- Display a specific screen saver after 5 minutes of inactivity
- Set the computer to standby after the screen saver has displayed for 10 minutes
- Turn off the monitor after 15 minutes of standby

For information about setting up a screen saver, or changing the appearance of display colors, type styles, background pattern, and wallpaper, see online Help.

Devices

Configuring the Mouse

Mouse drivers based on the Windows 95 mini-driver architecture are protected-mode drivers that provide better support for MS-DOS-based applications in the Windows 95 environment. Windows 95 makes mouse configuration and customization easier by providing a single Control Panel option for mouse settings.

Windows 95 Setup detects Microsoft, Logitech, and Microsoft-compatible mouse device drivers, and then replaces these with new drivers.

Mouse and Pointing Device Driver Overview

Windows 95 provides the following improvements in mouse and pointing device support:

- Supports Plug and Play for easy installation of pointing devices. For example, the VMOUSE driver interface supports Plug and Play.
- Provides smooth, reliable input when using the new protected-mode drivers.
- Supports multiple simultaneous devices; for example, when using PS/2® and serial devices at the same time.
- Eliminates the need to use separate MS-DOS-based mouse drivers.

Windows 3.1 required that an MS-DOS-based mouse driver be loaded before starting Windows to use a mouse in an MS-DOS-based application running in a window or running in a full screen.

The protected-mode Windows 95 VxD mouse driver provides mouse support for Windows-based applications, MS-DOS-based applications running in a window, and MS-DOS-based applications running in a full screen. These improvements result in zero use of conventional memory for mouse support in the Windows 95 environment. (However, most legacy real-mode drivers will run in Windows 95.)

In addition to better mouse services, Windows 95 allows the use of serial ports COM1 through COM4 for connecting a mouse or other pointing device.



To see the improvements in mouse driver support

1. Be sure the real-mode mouse driver from such entries as MOUSE.COM or MOUSE.SYS has been removed from CONFIG.SYS or AUTOEXEC.BAT.
2. Restart the computer, and start an MS-DOS-based application that supports the use of a mouse. For example, use an application such as Edit, and try the MS-DOS-based application both in a window and in a full screen. Notice that the mouse is available in both modes.

Devices

Configuring the Mouse

Changing Mouse Drivers

The Mouse option in Control Panel provides customization options, including setting the behavior of the mouse buttons and the mouse pointer. You can use either the Mouse option or Device Manager to change drivers for a pointing device. For information, see online Help.

For pointing device drivers that do not appear in the Select Device dialog box (that is, those that are not provided with Windows 95), the Windows Driver Library (WDL) provides support for additional drivers from other vendors. For information about the WDL, see [Windows 95 Resource Directory](#).

Devices

Configuring the Mouse

Configuring Mouse Behavior

You can use the Mouse option in Control Panel to configure buttons, customize mouse cursor appearance, set mouse speed, and other functions. This section briefly describes these functions. Different functions might be available, depending on the pointing device used with your computer.



To specify mouse behavior

- In the Mouse option in Control Panel, click the tab for the behavior you want to set, as described in the following illustrations. After changing the settings to the ones you want, click the Apply Now button.

For information about the configuration options, see the online Help.

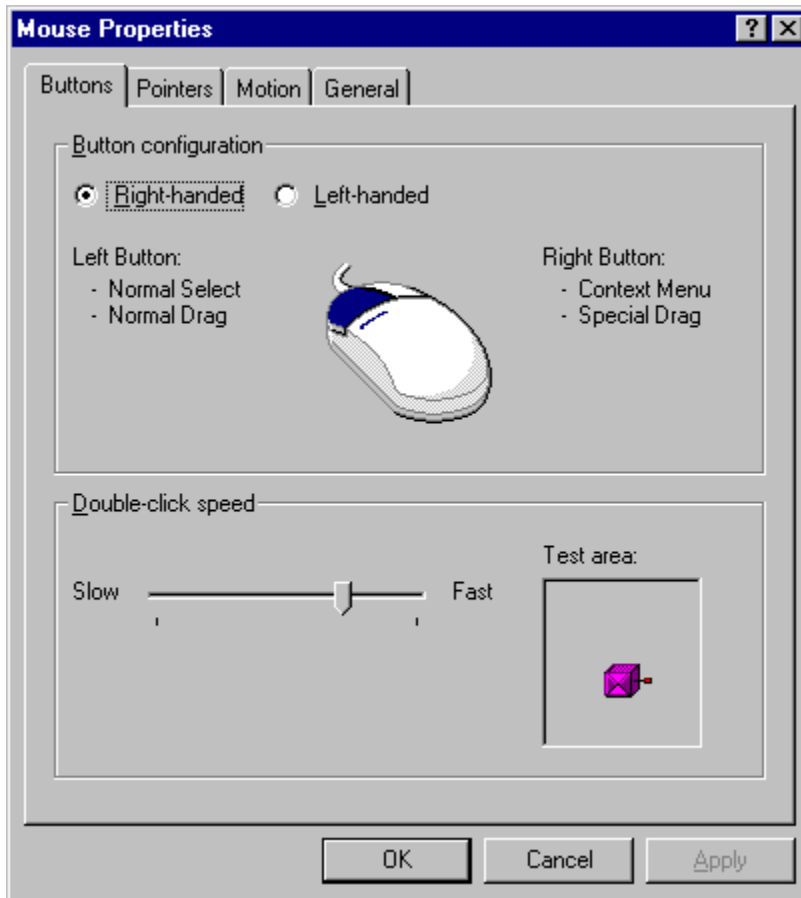

Configuring Communications Ports and Printer Ports

A communications resource is a physical or logical device that provides a single, asynchronous data stream. Serial ports, parallel ports, and modems are examples of communications resources. In Windows 95, VCOMM is the communications VxD that manages all access to communications devices. Port drivers use VCOMM to register themselves and to manage access to communications devices.

Two types of ports appear in Device Manager:

- Communications ports, also known as COM ports, serial ports, or RS-232 ports, are used to connect RS-232-compatible serial devices such as modems and pointing devices to the computer.
- Printer ports, also known as LPT ports or parallel ports, are used to connect parallel devices such as printers to the computer. For more information about configuring printer ports, see [Printing and Fonts](#).

Several types of communications ports might be listed in Device Manager:

- Serial ports, also known as RS-232 COM ports, to which external serial devices can be attached. These usually require a 9-pin or 25-pin plug. Serial ports designed for Windows 95 use the 16550A buffered UART, which has a 16-byte FIFO that gives the CPU more time to serve other processes and that can serve multiple characters in a single interrupt routine.
- An internal modem adapter. In addition to being installed in Device Manager, internal modems should also be installed and configured in the Modems option in Control Panel. For information, see [Modems and Communications Tools](#).
- A PCMCIA modem card, if it is using PCMCIA socket drivers designed for Windows 3.1 instead of Windows 95-compatible PCMCIA drivers. In this situation, a PCMCIA modem card is treated as if it were an internal modem adapter; that is, it must be installed as both a COM port and a modem.

When you install a communications device, Windows 95 automatically assigns COM names to communication ports, internal modem adapters, and PCMCIA modem cards according to their base I/O port addresses as shown in the following list:

- COM1 at 3F8 (input/output range)
- COM2 at 2F8
- COM3 at 3E8
- COM4 at 2E8

If a device has a nonstandard base address, or if all four standard ports have been assigned to devices, Windows 95 automatically assigns the modem to COM5 port or higher. Some 16-bit Windows 3.1 applications might not be able to access ports higher than COM4. Consequently, in the System option in Control Panel, you must adjust the base address in Device Manager or delete other devices to free up a lower COM port.

In addition, if some of the devices installed on a computer are not Plug and Play-compliant, you might have to change resource settings for their communications ports. You can change communications port settings by using Device Manager, as described in [Installing New Devices](#).

Tip For future reference, you might want to record the settings that appear on the Resources sheet for each communications port.

Real-Mode Drivers and the IOS.INI Safe Driver List

Microsoft strongly recommends that you use 32-bit, protected-mode drivers wherever possible. With protected-mode drivers, configuration information is stored in the Registry rather than in CONFIG.SYS or other files.

The following shows the general guidelines for device entries in CONFIG.SYS, and whether such entries are required or can be removed under Windows 95:

- When you use only protected-mode drivers, the only configuration information the operating system needs to know for system startup is the location of the Windows 95 system files and the directory for the swap file. You do not need to load drivers in CONFIG.SYS or AUTOEXEC.BAT.
- Any boot device in your computer that needs real-mode support does not require an entry in CONFIG.SYS. In the unusual case that the CD-ROM is part of system startup, entries for this device must be included in CONFIG.SYS.
- If your computer requires any real-mode drivers, an entry for loading the driver must be included in CONFIG.SYS and AUTOEXEC.BAT, as was true under earlier versions of MS-DOS.

Windows 95 automatically unloads any real-mode drivers for which it has protected-mode drivers to provide the same functionality. For example, the real-mode DBLSPACE.BIN driver is unloaded and the protected-mode DBLSPACE.VXD driver takes over. However, the protected-mode device driver should take over only when it guarantees similar functionality to the real-mode driver, not merely because it can drive the hardware.

Tip To determine whether a particular driver is running in real mode versus protected mode, click the Performance tab in the System option in Control Panel.

Real-mode drivers that can safely be replaced are identified in the safe driver list, which identifies drivers and TSRs that Windows 95 can replace with corresponding protected-mode drivers. The safe driver list (IOS.INI in the Windows directory) can include the following information:

- Name of the driver or TSR, using the same name as used in CONFIG.SYS or AUTOEXEC.BAT
- Driver requirements
- Whether the driver hooks INT 13
- Whether the driver monitors INT 13 (regardless of whether I/O is controlled by a protected-mode driver)
- Whether the driver accesses hardware directly

Windows 95 does not store the version number of the driver or TSR in the list, so the vendor must change the name of the driver if a future version is enhanced so that the driver is safe or unsafe.

By default, the following drivers are considered safe:

- MS-DOS 5.0-compatible real-mode block device drivers
- INT 13 driver (provides INT 13 functionality and directly accesses hardware)
- INT 13 monitors (hooks INT 13 for monitoring I/O but does not access hardware directly or modify the I/O buffer)
- INT 13 hooker (hooks INT 13 for altering I/O but does not access hardware directly)
- ASPI Manager (implements the Advanced SCSI Programming Interface for MS-DOS specification)
- CAM Manager (implements MS-DOS Common Access Method specification)

A real-mode driver is considered *unsafe* if it implements functionality that is not provided by protected-mode drivers. For example, a real-mode IDE or ESDI driver that uses dynamic encryption is an unsafe driver because Windows 95 does not support encryption. Windows 95 protected-mode drivers do not implement the following functions, so if a real-mode driver uses any of the following functions it is considered unsafe and should not be added to the safe driver list:

- Data compression (other than DriveSpace-compatible compression)
- Data encryption
- Disk mirroring

- Bad sector mapping
- Fault tolerance (maintaining ECC correction on a separate disk)
- IOCTLs defined or extended by the vendor

If Windows 95 provides an appropriate protected-mode driver, you should use only the real-mode driver in these cases:

- If the real-mode driver is used for a boot device.
- If an MS-DOS Mode application uses the driver's device, in which case the protected-mode driver must be unloaded in order to load the real-mode driver.

Tip for Using Real-Mode versus Safe Protected-Mode Drivers

If a real-mode driver provides better performance or provides some functions not present in the Windows 95 protected-mode driver, you should remove the real-mode driver from the safe driver list, so that Windows 95 uses real mode to access the driver. Similarly, if a real-mode driver can safely be taken over by a protected-mode driver, add the real-mode driver to the safe driver list.

To determine whether you can use a protected-mode driver, you will have to test the equivalent functionality provided from the protected-mode driver versus your existing real-mode driver.

The following is the syntax of the safe driver list in IOS.INI:

```
filename, qualifier_string ; comments
```

Qualifier string Meaning

do_not_care	Indicates that it is acceptable to load the protected-mode driver and not use the mapper for this real-mode driver because it doesn't matter whether it sees any I/O requests. This is the default.
must_chain	Implies that the device driver or TSR is safe, but it has an INT 13 hook that needs to see INT 13 requests. In this case, the protected-mode drivers are loaded, but the system routes the logical requests through the real-mode mapper and then switches back to protected-mode at the end of the INT 13 chain.
must_not_chain	Implies that the driver is safe as long as it does not see any INT 13 requests. In this case, the protected-mode drivers are loaded and the real-mode mapper is not used.
non_disk	Indicates a driver that controls a device that is not a disk, such as Interlnk. IOS issues INT 25 calls to all logical volumes in the system and determines whether the request is mapped to INT 13, ASPI, or CAM. If the request is not mapped, then this is a monolithic driver, as is the case for Interlnk. Adding non_disk prevents IOS from considering Interlnk in its safe-driver processing.
monolithic	Similar to non_disk . Any driver that is monolithic and safe must have this qualifier set to indicate to IOS that the protected-mode port drivers can be loaded and the driver's entry point can be handled to prevent contention.

IOS.INI also contains an Unsafe CD section in IOS.INI. Adding a driver to this section indicates that this CDFS will not be loaded on the CD drives that this driver controls.

The following is an example of some IOS.INI entries.

```
386max.sys      ; Qualitas
4dos.com        ; 4DOS shell program
```

```
ad-dos.com      ; Afterdark
ad_wrap.com    ; Afterdark
adi2.com       ; Afterdark
aspi3x90.sys   ; DTC SCSI no PM driver
...
[CDUnsafe]
drd600.sys     ; Acme 60X series CDROM
drd60asp.sys   ; Acme 60X series CDROM
drd60ps.sys    ; Acme 60X series CDROM
```

Tip for Troubleshooting Protected-Mode Drivers

If you believe that a protected-mode driver should be controlling a device, but the device appears with a real-mode driver in the System option in Control Panel, you can check entries in IOS.LOG. The IOS.LOG file in the Windows directory is created when a protected-mode driver is not available or if the operating system detects that an unknown device driver is controlling a device.

In most cases, the first line in IOS.LOG states why the protected-mode driver was not loaded. If the first line mentions MBRINT13.SYS, then the problem most likely is a virus (except if you are using a driver that replaces the master boot record).

Devices

Troubleshooting Device Configuration

This section describes specific problems in device configuration and how to correct them. For information about general procedures and Windows 95 tools that can be used in troubleshooting, see [General Troubleshooting](#).

Your first and best resource for diagnosing problems due to changing device settings is the Hardware Conflict troubleshooting aid in the online Help.



To use the Hardware Conflict troubleshooting aid

1. In the Help Topics window, click the Contents tab.
– Or –
In any Help window, click the Contents button.
2. Click Troubleshooting, click the option named If You Have A Hardware Conflict, and then follow the instructions on the screen.

Correcting Problems with Display

The display doesn't work correctly.

1. Restart the computer, and then press F8 when the Starting Windows 95 message appears.
2. Choose Safe Mode, which uses the standard VGA (640x480x16-color) driver.

If this resolves the display problem, then the display driver is probably involved. Try replacing the driver with a newer version, or reinstall the driver from the original disks.

Tip Problems can result when Windows 95 incorrectly assumes that a display adapter can support certain functionality. If this occurs, the side effects might be anything from small display irregularities to system lockup.

To determine whether any performance problems might be related to the display adapter, you can progressively disable enhanced display functionality using the System option in Control Panel. On the Performance tab, click the Graphics button, and then use the slider to select new settings. For information, see [Performance Tuning](#).

A display error occurs at a specific display resolution.

If your computer has problems with the display, determine whether the problems persist when you use lower screen resolutions and different color palettes with the display driver.



To see if the display error changes with resolution

1. In the Display option in Control Panel, click the Settings tab.
2. In the Color Palette box, click the box that displays available resolutions.
3. If the selection is other than 16-color, select 16-color.
4. Click the Apply button. Then shut down and restart the computer.
5. Retest the condition that was causing the display error. If the error does not recur, you might want to temporarily operate at a lower resolution until you can upgrade the display driver to a version that functions without error.

A display driver fails to work.

If the display driver fails (and changing resolutions doesn't resolve it), you should check or replace the current display driver.



To check the display drivers

1. In Device Manager, click the plus sign next to Display Adapters.
2. Double-click the specific display adapter shown (for example, Cirrus Logic).
3. In the properties dialog box, click the Driver tab.
4. Click each file shown in the Driver Files box. The File Version appears in the File Details box, if available (some vendor's display drivers might not contain version information).
5. Check displayed file versions for compatibility. Windows 95 display driver files have version numbers starting at 4.00 or higher.
6. If you have an incompatible driver, you can reinstall the original driver from the Windows 95 disks, or get new drivers from the Microsoft Download Service (MSDL) as described in [Windows 95 Resource Directory](#). If Microsoft drivers do not support the display adapter, contact the display-adapter vendor for updated drivers.



To check where the driver is loading from

- To ensure that a Windows 95 version of the display driver is installed, check the [boot] section of SYSTEM.INI for this entry:

```
display.drv=pnppdrv.drv
```

If this entry is specified, the display entries in SYSTEM.INI are ignored, and the display drivers are loaded from the Registry. If the entry specifies any driver other than PNPDRVR.DRV, the display

drivers are loaded from SYSTEM.INI.

The display adapter is not recognized.

If Windows 95 does not recognize the display adapter, try using the basic VGA drivers (a generic 640x480, 16-color driver). If you have a vendor-supplied driver disk for the display adapter, you can install the OEM drivers. If the drivers do not support Windows 95, some advanced display features are disabled.

Errors occur when initializing the display adapter.

If an error occurs during display adapter initialization, the computer stops responding. To restart the computer, press CTRL+ALT+DEL.

This problem might occur if you are using a video accelerator card and you change the display from the default setting (640x480, 16 colors) to 1024x768, 256 colors in the Display properties dialog box. Although Windows 95 might accept the changes, the error still results. The Super VGA (SVGA) driver (1024x768) included with Windows 95 is designed for nonaccelerated SVGA display adapters only. To correct this problem, change the display driver back to the default VGA setting.



To change your display driver back to VGA

1. Restart the computer, press F8 when you see the Starting Windows 95 message, and then choose Safe Mode.
2. In the Display option in Control Panel, click the Settings tab.
3. Click the Change Display Type button, and then click the Change button for the Adapter Type.
4. Click Show all Devices, click Generic Display Drivers, and then click OK. When asked whether to use the current driver or a new driver, click Current.

If you want to use a high-resolution display driver with Windows 95, consult your display adapter manufacturer for the proper driver to use.

A Windows 3.1 display driver doesn't support advanced features.

Windows 95 cannot support some display features when a Windows 3.1-compatible driver is being used. If you are using a Windows 3.x compatible display driver with Windows 95, some advanced features (such as dynamic resolution changes, font smoothing, and automatic fallback to VGA) will not work.

Some Windows 3.1 drivers require the screen resolution to be specified in the [boot.description] section of the SYSTEM.INI.

Motion is jerky during multimedia playback.

- Use Add New Hardware in Control Panel to verify that the appropriate display driver is installed for the display adapter you are using.
- Check to see if MSCDEX is installed. If so, remove it and use Windows 95 CD-ROM File System (CDFFS) drivers.
- If the problem occurs for MS-DOS-based applications, check and maximize available XMS memory in the VM.

Correcting Problems with SCSI Devices

A SCSI device fails to work.

The SCSI and CD-ROM support built into Windows 95 requires that CD-ROM drives provide SCSI parity to function properly. For many drives, this is a configurable option or is active by default. Examples of drives that do not provide or support SCSI parity are the NEC® CDR-36 and CDR-37 drives.

If you have trouble with a SCSI drive, make sure the SCSI bus is set up properly (refer to your hardware documentation for specific details).

In some cases, adding or removing a SCSI adapter might prevent your computer from starting correctly. Check the following:

- The ends of the SCSI bus must have terminating resistor packs (also called terminators) installed. If you have only internal or only external SCSI devices, the ends of the bus are probably the SCSI adapter and the last device on the cable. If you have both internal and external SCSI devices, the adapter is probably in the middle of the bus and should not have terminators installed. If you disconnect a device that has terminators installed (such as an external CD-ROM drive), be sure to install terminators on whatever device then becomes the last one on the bus. One of the devices on the SCSI bus (usually the adapter) should be configured to provide termination power to the bus. Windows 95 supports up to seven external SCSI devices in a chain, plus internal connections. In addition to the requirement that the last external and last internal SCSI device must be terminated, some hardware has additional requirements for where it must be placed in the SCSI chain.
- Removable media must be mounted on the drive before running Setup. If you have a SCSI hard disk drive that uses removable media, such as a cartridge drive, make sure the media is mounted on the drive before running Setup. If no media is mounted on the drive, errors might occur during Setup that prevent installation of Windows 95.

A SCSI device works with MS-DOS but not Windows 95.

For many SCSI hardware devices, you can specify command-line parameters when the driver is loaded. By default, the Windows 95 miniport driver runs without parameters (in the same way it does for real-mode drivers). If you want to use a command-line parameter, you can add it to the Settings property for the SCSI controller. For real-mode parameters that the controller supports (and if the device has a Windows 95 .MPD file), you can enter parameters in the Adapter Settings box in the controller's properties.

For information about the switches that can be used for a particular SCSI device, see the documentation from the device manufacturer. There are no additional parameters added by Microsoft.

For example, if your SCSI adapter has full functionality under MS-DOS, but not under Windows 95, you can add any device parameters previously specified in CONFIG.SYS to the Adapter Settings box. As another example, for Adaptec™ 7700 SCSI devices, you might specify **removable=off** to disable support for removable media if you want to load another ASPI removable disk.

Setup does not automatically detect the SCSI CD-ROM drive.

Windows 95 needs exact SCSI ID information for Toshiba® 3201, NEC 3x, and Texel 5201 CD-ROM drives. To make this information available to Windows 95, you must run the Add New Hardware wizard in Control Panel and manually choose to install specific hardware rather than running automatic detection of new hardware.

When running MSCDEX real-mode drivers, Windows 95 does not load protected-mode drivers from a SCSI CD-ROM drive.

If you are running MSCDEX.EXE and it loads real-mode drivers, you cannot load protected-mode drivers from a CD-ROM. In this case, you should comment out the lines in the AUTOEXEC.BAT and CONFIG.SYS files that MSCDEX.EXE placed there. For example:

```
rem device=c:\sbrpo\drv\sbpcd.sys/d:mscd001 /p:220
rem c:\windows\command\mscdex.exe /s /v /d:mscd001
```

Then you should restart the computer to allow Windows 95 to automatically detect the CD-ROM drive and its protected-mode drivers.

Notice that Windows 95 will automatically comment out these lines if the protected-mode drivers are on the CD-ROM from which you installed the drivers; that is, if you choose automatic detection, Windows 95 detects the hardware and its drivers and automatically comments out the real-mode drivers.

Setup doesn't recognize the correct SCSI CD-ROM drive.

Windows 95 Setup does not recognize multiple CD-ROM drives connected to the same SCSI host adapter. Therefore, if it doesn't recognize one of the CD-ROM drives, it is a hardware problem. For example, it could be caused by a legacy adapter with more than one device with the same SCSI ID.

A SCSI tape drive or scanner does not show up in Device Manager.

Windows 95 does not assign drive letters to tape drives and scanners because they have no drive to assign a letter to, that is, they have no official class. Therefore, they appear as Unknown Devices in Device Manager. After you start Windows 95, it asks if you have a driver for these devices. If you have Windows 95 drivers, click Yes. To use existing real-mode drivers, click No, and then type the path to where the drivers are located. Windows 95 will continue to recognize and support these devices even though they are listed as Unknown Devices.

A SCSI drive does not show up in My Computer.

This probably indicates that there is something wrong with the SCSI drivers in CONFIG.SYS and AUTOEXEC.BAT, or that the protected-mode SCSI drivers fail to load. Look for an IOS.LOG file and check its entries, as described in [Real-Mode Drivers and the IOS.INI Safe Driver List](#).

Running the DIR command on the SCSI drive produces strange characters.

If you type `dir` and strange characters appear on the screen, the hard disk might be a SCSI drive that requires double buffering which is not loaded. Verify that MSDOS.SYS has **DoubleBuffer=1** in the [Options] section. (However, if you start the computer using MS-DOS version 6.0 or higher, double-buffering is provided when SMARTDRV.EXE is loaded in CONFIG.SYS.)

Correcting Problems with Other Devices

The system stalls when accessing CD-ROM.

After you press CTRL+ALT+DEL to shut down and restart the computer, Windows 95 might be unable to find the CD-ROM or stall when trying to access the drive; sometimes, pressing CTRL+ALT+DEL will not reset the computer. This might occur if Windows 95 is relying on real-mode drivers for the Sound Blaster® or Media Vision™ Pro Audio proprietary CD-ROM drive. If this is the case, you cannot access anything on the CD-ROM because its drivers cannot load. If this happens, turn off and then restart the computer. Use the Add New Hardware option in Control Panel to install the protected-mode drivers provided with Windows 95 for the specific CD-ROM device.

CD-ROM performance problems when AutoPlay is enabled.

This problem sometimes occurs with both protected-mode and real-mode (MSCDEX) drivers. To fix it, turn off AutoPlay, which is enabled by default, and then turn it back on again.

.WAV files cannot be played.

If Windows 95 cannot recognize the sound card, you might not be able to play .WAV files.



To verify sound card settings

1. In Device Manager, click the Sound controller.
2. Double-click the specific sound card, and then in the card's properties, click the Drivers tab so you can verify the drivers.
3. Click the Resources tab, and verify IRQ settings.
4. Check the Conflicting Device List, and verify that no conflicts for the sound card settings appear in the list.

Ports for sound cards with multiple CD-ROM adapters are not detected.

If a sound card has multiple CD-ROM adapters, they often include a program that activates the port to be used. This program must run before Windows 95 runs. If it doesn't, Windows 95 won't detect the port.

An input device fails.

- Check the physical connection.
- In Device Manager, check the driver used for the device.
- Check for conflicts with the I/O and IRQ resources used.
- Check for conflicting drivers or applications.

The mouse moves erratically or keyboard input fails.

- In Device Manager, check the mouse and keyboard drivers, replacing them if necessary.
- In the Mouse option in Control Panel, check Motion configuration for pointer speed.
- Check the port used for the mouse.
- Check the physical connection of the mouse and keyboard.
- Make sure there are no entries for real-mode mouse drivers in CONFIG.SYS, AUTOEXEC.BAT, WIN.INI, and SYSTEM.INI.
- When the Starting Windows 95 message appears, press F8, and then choose the Logged option. Check the BOOTLOG.TXT file and verify that the mouse driver is loading.

Mouse reports GROWSTUB errors.

If you were using the Microsoft Mouse Manager with Windows 3.1, Windows 95 Setup automatically updates the POINTER.EXE and POINTER.DLL files in the Mouse directory. If these files are not updated correctly, the mouse might stall and report GROWSTUB as a running task in the Close Program dialog box. To fix this problem, remove all references to the mouse in the AUTOEXEC.BAT and CONFIG.SYS files, and make sure the correct POINTER files were copied to the Mouse directory and not just the Windows directory.

Advanced Power Management 1.0 (APM) is not available.

Windows 95 Setup installs APM support automatically if it was installed on the computer previously. You can enable APM support after Setup by using Device Manager.



To enable APM under Windows 95 if it was disabled during Setup

1. In Device Manager, click System Devices, click the APM entry, and then click Properties.
2. In the APM properties, click Settings.
3. In the Settings dialog box, click Enable Power Management Support if this option is not checked.
If no APM drivers were installed under previous versions of Windows, no check mark appears. Checking this box enables the drivers.
4. Click Force APM 1.0 Mode.
This option forces Windows 95 to use an APM 1.1 BIOS in APM 1.0 mode. In some cases, a BIOS incorrectly handles the new functions provided by APM 1.1 but functions properly when used in 1.0 mode. On some computers, this is checked automatically during Setup.
5. Click Disable Intel SL Support to disable the SL check.
In some cases, a BIOS incorrectly handles an unsupported call to the APM interfaces of some SL-type chipsets, causing the computer to stop responding. Disabling this option prevents the system from not responding.
6. Click Disable Power Status Polling to prevent Windows 95 from calling the APM interface to check current battery level.
Windows 95 calls the APM interface for this purpose with greater frequency than earlier versions of Windows 3.x, causing some computers to shut down. Disabling this feature prevents this, but also disables the battery meter.

Introduction

This chapter introduces Windows 95 disk and file system support. It describes how to use Windows 95 utilities to partition and format disks, and how to use DriveSpace, Disk Defragmenter, and ScanDisk to manage disks and data. This chapter also discusses how to manage long filenames.

- [Disks and File Systems: The Basics](#)
- [Disks and File Systems: The Issues](#)
- [Partitioning Hard Disks](#)
 - [Partitioning Drives](#)
 - [Formatting a Hard Disk](#)
 - [Assigning Drive Letters for Removable Media](#)
- [Disk Management Overview](#)
- [Managing the Recycle Bin to Free Disk Space](#)
- [Using Microsoft Backup](#)
- [Defragmenting Disks](#)
- [Using ScanDisk](#)
- [Using Disk Compression with Windows 95](#)
 - [Overview of Compressed Volume Files and Host Drives](#)
 - [Using DriveSpace for Disk Compression](#)
- [Microsoft Plus! Utilities for Disk Management](#)
 - [DriveSpace 3 Compression: An Overview](#)
 - [Scheduling Programs with System Agent](#)
- [File Systems Overview](#)
- [Using Long Filenames](#)
 - [Long Filename Support in Windows 95](#)
 - [Long Filenames and Network Compatibility](#)
 - [Administrative Considerations for Long Filenames](#)
- [Technical Notes on Disk Device Support](#)
 - [Supported Disk Devices](#)
 - [VCACHE and CDFS Supplemental Cache](#)
- [Troubleshooting File and Disk Problems](#)

Disks and File Systems: The Basics

The new 32-bit, protected-mode file system support in Windows 95 allows optimal access to hard disks, CD-ROM drives, and network resources. The new file system support means faster, better performance for all file I/O operations than what was available under earlier version of MS-DOS or Windows.

Because of enhancements to the file systems, there is no longer an eight-character limit on filenames that was imposed by the FAT file system under MS-DOS. You can use long filenames and directory names in Windows 95 and in any applications that support long filenames.

The enhanced FAT file system in Windows 95 also permits exclusive access to a disk device for file system utilities. File system utilities, such as ScanDisk, require exclusive access to the file system to ensure data integrity in a multitasking environment. Otherwise, if a file on the disk were to be saved while the utility was writing information to the disk at the same time, data corruption could occur.

Exclusive disk access means you can now run disk management and optimization utilities without quitting Windows. You can even complete tasks such as disk defragmentation without stopping work in other applications. The exclusive access support is used by the disk utilities provided with Windows 95 and can be used in Windows-based disk management utilities from any vendors that take advantage of the related API in their utilities.

The disk utilities provided with Windows 95 include the following.

Fdisk and Format.

These utilities, which you can use to partition and format disks, behave exactly as their counterparts in MS-DOS versions 6.x. You can use a graphical form of Format in Windows Explorer.

Disk Defragmenter.

This utility (also called a disk optimizer) is used to defragment information on a disk. Using Disk Defragmenter regularly helps to minimize the area on the disk in which Windows 95 needs to look to load information.

DriveSpace (DBLSPACE).

The built-in support for DriveSpace disk compression is completely compatible with DoubleSpace and DriveSpace disk compression provided with MS-DOS 6.x. Compression is performed by using a 32-bit virtual device driver that delivers improved performance over previously available real-mode compression drivers, and frees conventional memory for use by MS-DOS-based applications. Existing users of DoubleSpace and DriveSpace do not need to change the compressed volume file (.CVF) that they are using currently, and they do not need to take any special actions when installing Windows 95.

ScanDisk.

This graphical disk analysis and repair tool runs under Windows 95 to help users check the integrity of disks and to remedy the problems it detects. Users can choose to scan the computer's files and folders or the disk surface for errors.

Disks and File Systems: The Issues

You should use disk and file management utilities designed specifically for Windows 95. This way, you can avoid losing long filenames and data. In some cases (as described in [Using the LFNBK Utility for Temporary Compatibility](#)), you can use the LFNBK utility to remove and later restore long filenames on a disk so that you can run a utility that is not compatible with long filenames.

Caution Stacker® 4.0 from STAC Electronics and similar disk optimization utilities, including DriveSpace 6.x for MS-DOS, are not compatible with long filenames. If you already have such compression software on the computer, you should not experience problems. However, if you install such software under Windows 95, the long filenames already on the computer will be destroyed, and other critical errors could occur.

Contact the software manufacturer for information about Windows 95-compatible upgrades for your disk utilities.

You can ensure disk integrity by putting ScanDisk in the STARTUP directory so that it runs each time the operating system starts. Also, back up critical files once a week to ensure data security, and run Disk Defragmenter at regular intervals to optimize disk I/O performance.

Windows 95 automatically provides long filename support. However, Windows 95 file systems and OS/2 HPFS each have slightly different ways of defining 8.3 filename aliases for long filenames. If you are using a mixed network environment, be sure to understand the differences (as described in this chapter). Then to help minimize any naming conflicts, define and publish a file naming policy for users who share files.

Partitioning Hard Disks

This section describes how to use the Fdisk utility to configure a hard disk. For example, if you want to combine several partitions into one large partition, you must use Fdisk; there is no method for automatically combining partitions.

Caution Do not repartition the hard disk by using Fdisk if the computer has certain types of partitions, such as those created by Disk Manager, Storage Dimensions SpeedStor®, Priam®, or Everex™ partitioning programs, which replace the BIOS in interactions between MS-DOS and the hard-disk controller. Instead, use the same disk-partitioning program that was used to partition the disk. For example, if you use SpeedStor on a computer that has more than 1024 cylinders, do not carry out the following procedures.

To determine whether the computer has a partition created by using one of these disk-partitioning programs, search for the following files: DMDRVR.BIN (Disk Manager), SSTOR.SYS (SpeedStor), HARDRIVE.SYS (Priam), and EVDISK.SYS (Everex). Usually, you will find **device=** entries for these files in CONFIG.SYS. If you need help repartitioning the hard disk or are unsure whether the BIOS is being replaced, contact the manufacturer of the original disk-partitioning program.

To configure a hard disk, you must perform the following tasks:

- Create a startup disk by using the Add/Remove Programs option in Control Panel
- Back up the files on the hard disk
- Repartition the hard disk by using Fdisk
- Format the hard disk
- Restore the backed-up files

The steps for partitioning and formatting are described in the following section.

Partitioning Drives

If you want to repartition a hard disk into one drive, you must first use Fdisk to delete all existing partitions and logical drives, and then create a new primary partition and make it active. You can also repartition a hard disk so that it has more than one logical drive. Notice that, although Windows 95 replaces MS-DOS, the partitions that Fdisk creates are still called DOS partitions.

Although Fdisk is an MS-DOS-based application in Windows 95, however, it can run in a window (a VM).

The Windows 95 emergency startup disk contains a copy of Fdisk, which you can use if a hard disk becomes unreadable.

To configure a hard disk by using Fdisk, complete the following tasks:

- Delete DOS partitions, logical drives, the extended DOS partition, and the primary DOS partition
- Create a new primary DOS partition
- Create an extended partition and logical drives, if you want any

Caution If you use Fdisk to repartition a hard disk, all the files on the original partitions will be deleted. Be sure to back up all data files on a partition before using Fdisk.



To start Fdisk

- At the command prompt, type **fdisk**

-Or -

If you are starting Fdisk from a startup disk, make sure the disk is in drive A, and then restart the computer by pressing CTRL+ALT+DEL. At the command prompt on the A drive, type **fdisk**

When you run Fdisk, the Fdisk Options screen appears, in which you can choose to do the following:

- Create a partition or logical drive
- Set the active partition
- Delete a partition or logical drive
- Display partition information

If the computer has two or more hard disks, Fdisk displays a fifth option on the Fdisk Options screen named Change Current Fixed Disk Drive. You can switch to another disk drive by choosing this option. Changing the current hard disk drive while using Fdisk doesn't change the current drive when you return to the command prompt.

Each Fdisk screen displays a Current Fixed Disk Drive line, followed by a number. If the computer has only one hard disk drive, this number is always 1. If the computer has more than one hard disk drive, the number shows the disk Fdisk is currently working on. The first hard disk drive on the computer is 1, the second is 2, and so on. The Current Fixed Disk Drive line refers only to physical disk drives.

Note If you installed a disk-compression program from Microsoft or another vendor, Fdisk displays the uncompressed, not the compressed, size of the drives. Also, Fdisk might not display information about all the drives used by a disk-compression program from another vendor.

Deleting Partitions and Logical Drives

You can use Fdisk to delete partitions before creating a new primary partition. You must delete partitions in the following order:

- Any non-DOS partitions
- Any logical drives in the extended DOS partition
- Any extended DOS partition
- The existing primary DOS partition

Important Back up your files before deleting partitions. If the computer has a non-DOS partition on a hard disk, copy the data files from the partition to floppy disks or a network drive to back them up. For more information, see the documentation that came with the non-MS-DOS operating system or the disk-partitioning program from another vendor.



To delete a partition or logical drive

1. In the Fdisk Options screen, press 3, and then press ENTER. The Delete DOS Partition Or Logical DOS Drive screen appears.
2. Press the number as shown on the screen for the kind of partition you want to delete, and then press ENTER.
3. Follow the directions on the screen, and repeat the steps for deleting any additional logical drives or partitions.

If Fdisk cannot delete a non-DOS partition, quit Fdisk, delete the non-DOS partition by using the software used to create it, and then restart Fdisk.

Creating a Primary MS-DOS Partition

After you have deleted a primary DOS partition, you can create a new primary DOS partition.



To create a primary DOS partition

1. In the Fdisk Options screen, press 1, and then press ENTER. The Create DOS Partition Or Logical DOS Drive screen appears.
2. Press 1, and then press ENTER. The Create Primary DOS Partition screen appears.
3. If you want the partition to be the maximum size, press ENTER. Then insert a startup disk in drive A, and press any key.

If you do not want the partition to be the maximum size, press N, and then press ENTER. Another Create Primary DOS Partition screen appears.

4. To specify the partition size you want, follow the instructions on-screen, and then press ENTER. You can specify the partition size as a percentage of disk space or in megabytes of disk space. If you specify a percentage of disk space, include a percent sign (%) after the number.
5. Press ESC to return to the Fdisk Options screen, and follow the instructions on-screen to make the primary DOS partition active. Then return to the Fdisk Options screen.

If you have not allocated all the space on a hard disk to the primary DOS partition, you can create an extended DOS partition and logical drives by choosing the Create Extended DOS Partition option in Fdisk. You specify the partition size you want as a percentage or number of megabytes of disk space.

If you don't want to create an extended partition, press ESC to quit Fdisk. Then insert a startup disk in drive A, and press any key to continue.

Formatting a Hard Disk

You cannot format a hard disk by using Windows 95 Setup. The hard disk must be formatted before you can run Windows 95 Setup. However, if Windows 95 is already installed, you might need to reformat the hard disk, as described in the following procedure.

Note If the disk was compressed by using DriveSpace, you must use the Format option in DriveSpace to format the compressed drive.



To format a hard disk drive

- In Windows Explorer, right-click the drive icon for that disk, and then click Format.
You cannot use this method on a hard disk containing open files, including the drive where Windows 95 resides.

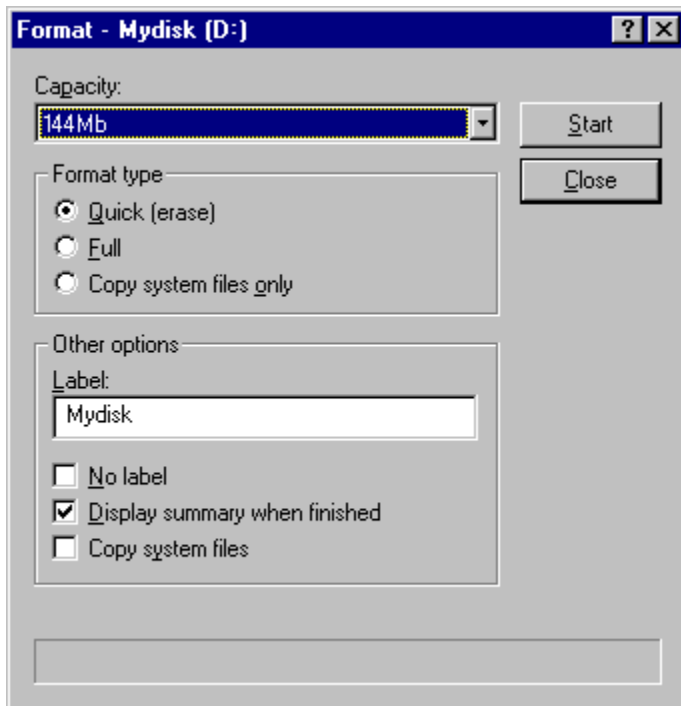

To format a hard disk by using the Windows 95 startup disk

1. Make sure a startup disk is in drive A. Then, at the command prompt, type the following:

format *drive_letter*:

For *drive_letter*, type the letter of the drive you want to format.

If you are formatting drive C, copy system files to the hard disk by typing the following at the command prompt:

format c: /s

When the warning message appears, proceed with formatting by pressing Y. Then press ENTER.

2. When formatting is complete, type a volume label (if you want one), and then press ENTER.
3. If you want to format other drives, repeat steps 1 and 2.
4. Remove the floppy disks from all floppy disk drives, and restart the computer by pressing CTRL+ALT+DEL.

Assigning Drive Letters for Removable Media

Whenever a removable media device is present, the Windows 95 volume tracker ensures that the correct media is in the device and reports improper media removal or insertion.

The volume tracker keeps track of removable media in two ways:

- On non-write-protected floppy disks, the volume tracker writes a unique ID in the disk's FAT header. This ID is different from the volume serial number
- On write-protected floppy disks, the volume tracker caches each disk's label, serial number, and BIOS parameter block

Windows 95 supports existing removable media with MS-DOS-compatible partitions, which usually are created by using Fdisk utilities from other vendors. You can use Fdisk for Windows 95 to create partitions on INT 13-based removable media.

Windows 95 does not perform volume tracking based on the volume serial number because all removable media do not have serial numbers or some might have duplicate serial numbers (as is the case with bulk-formatted floppy disks). Therefore, the file system driver must assign unique serial numbers to removable media the first time there is a request to mount the specific media, unless unique numbers have already been written to the media. These unique numbers identify the media for volume tracking.

Note For volume tracking with NEC® floppy-disk change detection, if the system detects a change line on a volume, the change line is used for subsequent I/O requests to the media.

You can control the number of drive letters to be reserved during system startup for each removable media drive.



To reserve drive letters for removable media

1. In the System option in Control Panel, click the Device Manager tab.
2. In the hardware list, double-click the item that represents the removable device.
3. In the Properties dialog box, click the Settings tab.
4. In the Reserved Drive Letters area, select a letter in the Start Drive Letter list to define the first drive to be assigned to this device. In the End Drive Letter list, select the last drive to be assigned to this device. Click OK.
5. To close the System properties dialog box, click OK.
6. When prompted, restart the computer.

The **MaxRemovableDrivePartition** entry in the Registry allocates the drive letters to be used by partitions on removable media. If this entry is not present in the Registry, the number of drive letters to be assigned is based on the number of partitions present on the media when the system starts. If no media are present at startup, Windows 95 reserves one drive letter for each of the removable media.

To support variable-sized disks and partitions, Windows 95 recalculates the disk geometry every time a media change is detected. If you insert media with more partitions than specified by the **MaxRemovableDrivePartition** entry in the Registry, a message warns you that some partitions on the media are not accessible in the current configuration and prompts you to increase the value of **MaxRemovableDrivePartition**.

Disk Management Overview

Windows 95 includes several tools for managing disks, protecting data, and ensuring good disk performance. To keep your computer in good working order, use these programs on a regular basis. To determine which tasks are necessary to manage your computer, consider the following.

To ensure that

Files aren't lost if the hard disk fails

The computer can access files quickly and efficiently

Lost clusters don't take up space on a disk, or the hard disk is not damaged

Space is available on the hard disk

Do this

Run Microsoft Backup or a network backup agent. For information, see [Remote Administration](#).

Defragment the hard disk. For information, see [Defragmenting Disks](#).

Run ScanDisk. For information, see [Using ScanDisk](#).

Use various tips for freeing disk space, and use disk compression. For information, see [Managing the Recycle Bin to Free Disk Space](#) and [Using Disk Compression with Windows 95](#).

The routine for managing a computer's hard disks might include automatically running ScanDisk when starting the computer to check the integrity of the hard disk, backing up files once a week, and occasionally using the Disk Defragmenter to defragment the hard disk. No matter what your computer management plan, carry it out at regular intervals.

You can also use a scheduling utility such as System Agent in Microsoft Plus! for automatic disk maintenance. For information, see [Microsoft Plus! Utilities for Disk Management](#).

Note For best results, do not run other programs while running either Disk Defragmenter or ScanDisk. Although you can use the computer for other tasks while running either of these utilities, each time you write to the disk, the utility automatically reinitiates itself to work with the current view of the disk.

About Volume Locking for Disk Utilities

Windows 95 provides volume-locking APIs that applications such as disk utilities can use to control direct disk access when the computer uses the Windows 95 32-bit file system. (In Windows for Workgroups 3.11, VFAT generated an error whenever a disk utility tried to access the drive in protected mode.)

Disk utilities usually make absolute INT 25 and INT 26 disk calls, which do not require file system drivers. Instead of calling INT 21 and INT 13 to access the disk, the application calls INT 25 for reads and INT 26 for writes.

When an application is going to change the disk structure (such as a disk utility preparing to defragment the disk), it should first use the volume locking APIs to lock that volume or drive, so that no other application can write to that volume and interfere with its operations. When the application has completed its work, it must unlock the volume before the system can resume normal operation.

If a utility does not use volume locking before it attempts to read from or write to the disk, Windows 95 returns an error and causes it to fail. All utilities included with Windows 95, such as the Disk Defragmenter and ScanDisk, use volume locking. Such utilities cannot be used with Windows NT because Windows NT does not allow utilities to make direct calls to the hardware.

Managing the Recycle Bin to Free Disk Space

When you delete a file or directory, it is moved to the Recycle Bin, but it still takes up space on the hard disk. You can use one of the following methods to ensure disk space is not being used by the contents of the Recycle Bin:

- Avoid moving items to the Recycle Bin by pressing SHIFT when you use the mouse or keyboard to delete items.
- Avoid moving items to the Recycle Bin by specifying that items are removed from the disk immediately when you delete them.
- Empty the Recycle Bin regularly.

You can also configure the Recycle Bin to use only a set amount of space so that you are prompted to empty the bin more often.



To configure the Recycle Bin



1. Right-click the Recycle Bin icon, and then click Properties.

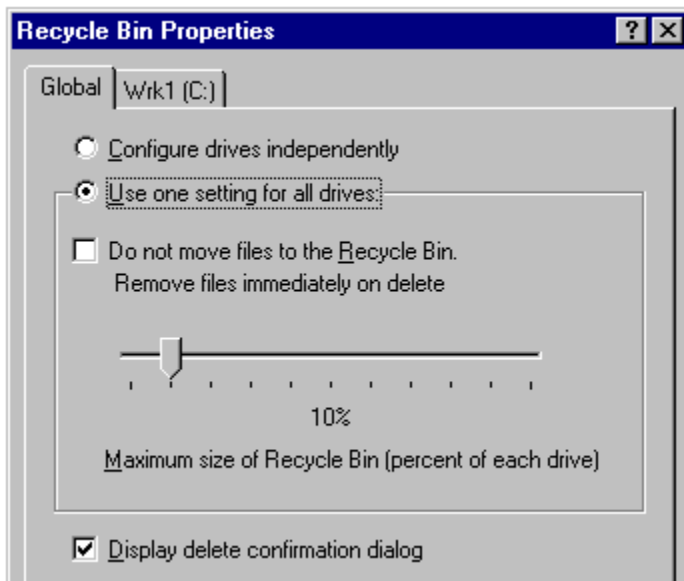

Note You can configure properties separately for each hard disk drive on the computer by clicking the option named Configure Drives Independently.

2. If you want deleted items to be removed from the Recycle Bin immediately, make sure Do Not Move Files To The Recycle Bin is checked.
3. If you want to specify the amount of hard disk space the Recycle Bin can use, drag the slider to the desired percentage.

For more information about the Recycle Bin, see online Help.

Using Microsoft Backup

Microsoft Backup, a Windows 95 utility for backing up data, provides options for backing up files to floppy disks or tapes, restoring from disks or tapes, and comparing backup file sets to files on the hard disk. Microsoft Backup supports the QIC 113 backup tape specification, which includes support for long filenames.

For users familiar with the Windows 3.1 Backup utility, the following list describes important differences in Backup under Windows 95:

- This version of Microsoft Backup does not support restoring backup sets created by MS-DOS version 6.x backup utilities.
- The recommended method for creating a complete backup file set for the computer is the Full System Backup option. This option automatically selects the files required for a system backup. If you decide to modify the default selections (by clearing the check boxes for some folders), be sure that you select at least the Windows directory; otherwise, the Registry will not be backed up.
- When using the Backup tab in the Settings Options dialog box, notice that selecting Differential under the Type Of Backup option causes the utility to back up only files that have changed since the last time Backup was run. With this setting, new files will not be added to the file set and deleted files will not be removed.

For information about the Arcada® and Cheyenne® network backup agents, see [Remote Administration](#). For information about how to use Backup, see online Help, which includes a list of the tape drives that are supported under Windows 95 and compatible with Windows 95.

Defragmenting Disks

Over time, as programs read from and write to a hard disk, information stored on the disk can become fragmented — that is, files are stored in noncontiguous sectors. Fragmentation doesn't affect the validity of the information — the files are still complete when they are opened. But it takes much longer for the computer to read and write fragmented files than it does for unfragmented files.

To improve file access time, you can defragment uncompressed drives and compressed DriveSpace or DoubleSpace drives.

Important Disk Defragmenter does not work with compressed drives created with most compression software from other vendors (such as those compressed with SuperStor), read-only drives, locked drives, network drives, FFS drives, or drives created with ASSIGN, SUBST, or JOIN.



To defragment a disk drive

1. Click the Start button, click Run, and then type **defrag**

2. In the Select Drive dialog box, specify the drive that requires defragmentation, and then click OK.

The Disk Defragmenter displays a dialog box telling you whether defragmentation is recommended for this disk or not. If this disk has low fragmentation, the Disk Defragmenter will not recommend defragmentation.

3. Click the Advanced button if you want to do any of the following:

- Specify a defragmentation method (all files and free space, files only, or free space only). Depending on how badly the disk is defragmented, you can reduce the amount of time required to defragment a disk by choosing to defragment only files or free space.
- Specify whether the drive should be checked for errors.

You can check the option to save these optimization preferences for use each time you run Disk Defragmenter.

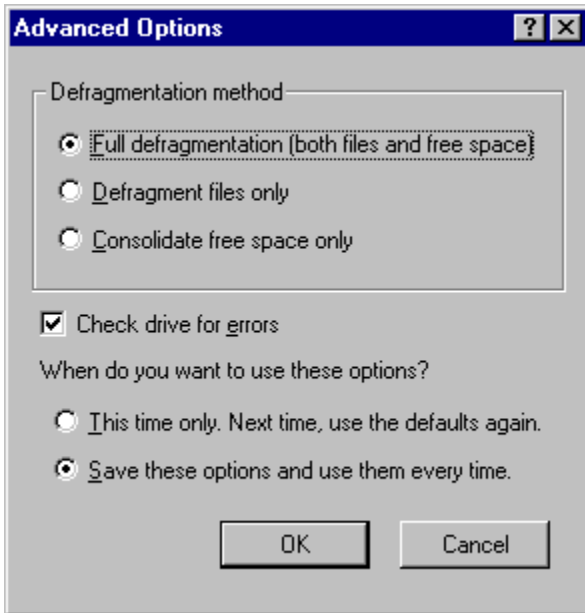

4. In the Disk Defragmenter dialog box, click Start to begin defragmenting the drive.

Tip Showing details while the Disk Defragmenter is running causes it to take longer than it does when showing only summary information or running it minimized. For quickest performance, minimize the Disk Defragmenter window while the utility is running.



To see defragmentation information for a particular drive

1. In My Computer, right-click the drive's icon, and then click Properties.
2. Click the Tools tab.

The Tools properties dialog box shows the number of days since the last complete defragmentation process ran on the drive. You can also run Disk Defragmenter from this dialog box.

You can also use the **defrag** command with switches in a batch file. For more information about this command, see [Command-Line Commands Summary](#).

Using ScanDisk

ScanDisk is a full-featured disk analysis and repair program. ScanDisk runs automatically when you start Windows 95 Setup. After Windows 95 is installed, you can use ScanDisk on both uncompressed and compressed drives. ScanDisk checks compressed drives created with compression software from other vendors, but it checks these drives as if they are uncompressed. ScanDisk, however, can provide a detailed analysis of compression structures on DoubleSpace and DriveSpace drives.

Note Windows 95 provides two versions of ScanDisk: a new graphical Windows-based version that you can run from the Start menu or from Windows Explorer, and an MS-DOS-based version that is contained on the Windows 95 startup disk. For information about running ScanDisk from the command line or in batch files, see [Command-Line Commands Summary](#).

ScanDisk checks and fixes problems in the following areas on hard disk drives, floppy disk drives, RAM drives, and memory cards:

- File allocation table (FAT)
- Long filenames
- File system structure (lost clusters, cross-linked files)
- Directory tree structure
- Physical surface of the drive (bad sectors)
- DriveSpace or DoubleSpace volume header, volume file structure, compression structure, and volume signatures

Note ScanDisk cannot find or fix errors on CD-ROM drives, network drives, or drives created by using **assign**, **subst**, **join**, or **interlnk**.

ScanDisk can check and repair mounted DriveSpace or DoubleSpace drives. You can run ScanDisk from the command prompt to check and repair unmounted compressed volume files (CVFs). When you run ScanDisk to check a compressed drive, by default, ScanDisk checks the host (physical) drive first. In general, you should allow it to do so because an error on the host drive could cause problems with the compressed drive.



To run ScanDisk

1. Click the Start button, click Run, and type **scandisk**

Note See the following procedure to run ScanDisk on unmounted CVFs.

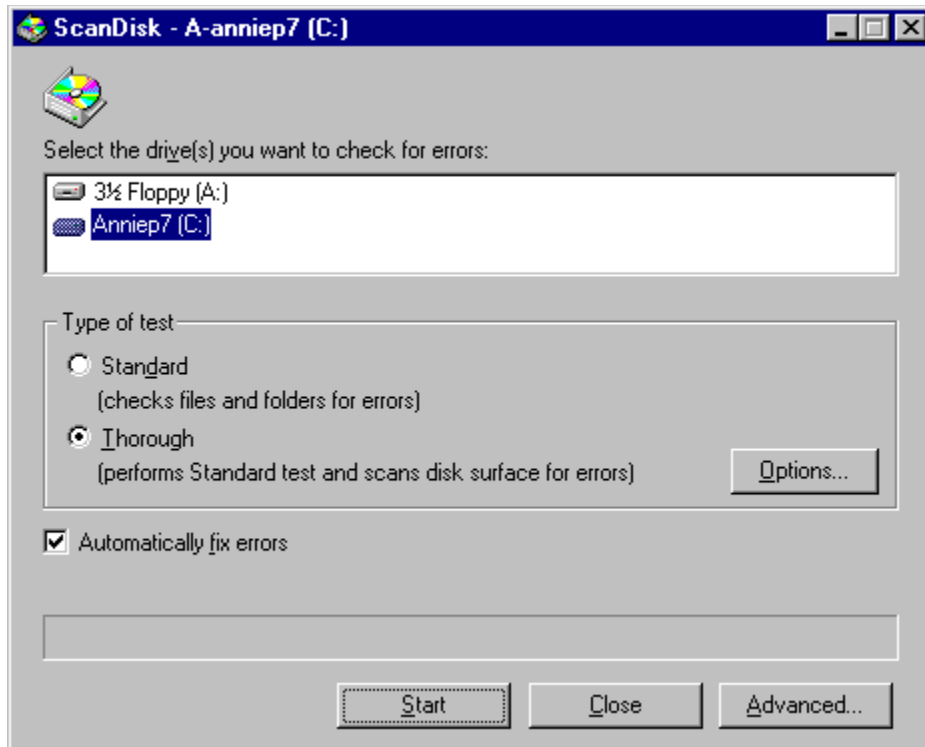

2. Click the drive you want to analyze or repair.
3. In the Type Of Test area, click Standard or Thorough.
 - Standard checks the files and folders on the selected drive for errors.
 - Thorough checks files and folders for errors, but it also checks the physical integrity of the disk's surface.
4. If you do not want ScanDisk to prompt you before repairing each error it finds, make sure Automatically Fix Errors is checked.
5. If you are running a thorough test, click the Options button to specify which areas of the disk to check or which type of processing to perform. Select the options you want to use, and then click OK.

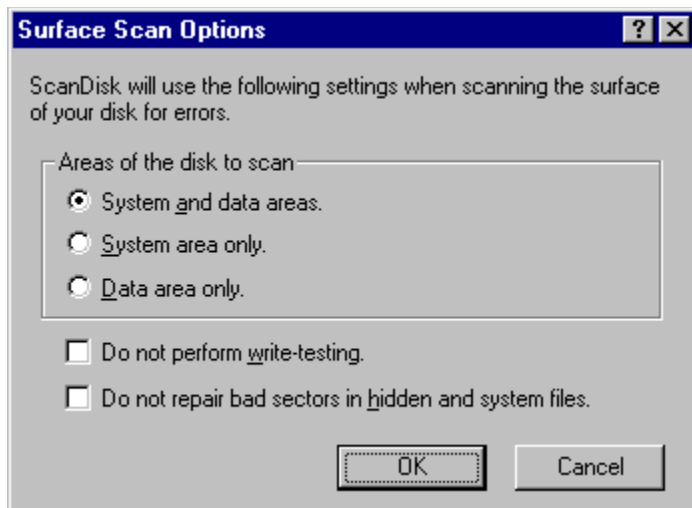

6. Click the Advanced button to set advanced options as needed, and then click OK. For information about each option, see online Help.

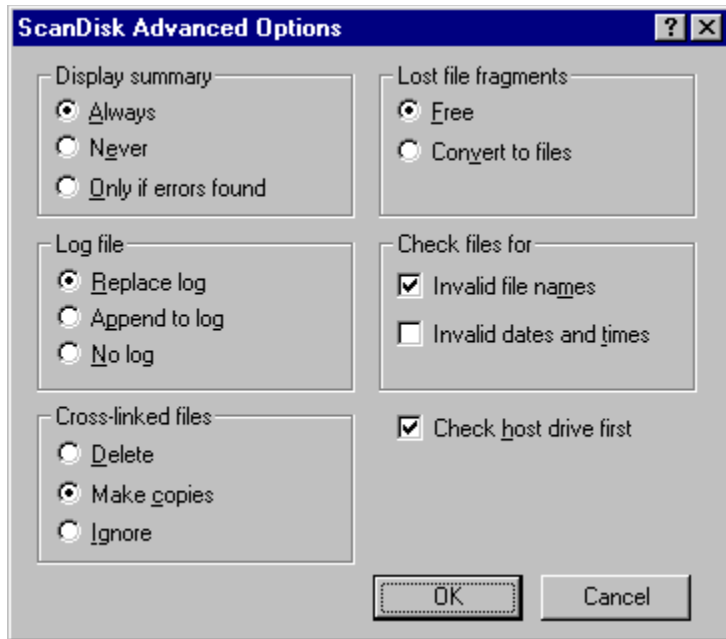

7. To begin checking the disk, click the Start button.



To run ScanDisk on unmounted CVFs

- Click the Start button, click Run, and then type one of the following commands:

scandisk drvspace.nnn

-Or -

scandisk dblspace.nnn

where *nnn* is a number. This starts an MS-DOS session and runs ScanDisk on the corresponding DriveSpace or DoubleSpace CVF.

Tips for Running ScanDisk

- Consider putting ScanDisk in the STARTUP directory to run it each time you start your computer.
Or, if you have installed Microsoft Plus! for Windows 95, keep ScanDisk in the list of scheduled programs run by System Agent. For more information, see [Microsoft Plus! Utilities for Disk Management](#).
- You can also run ScanDisk from the Tools properties dialog box for a drive. To do this, right-click that drive's icon, click Properties, and then click the Tools tab. Click the Check Now button to begin running ScanDisk.
- You can use the command-line equivalent command, **scandskw**, in a batch file. For more information about this command, see [Command-Line Commands Summary](#).

Disks and File Systems

Using Disk Compression with Windows 95

With Windows 95 DriveSpace, you can compress drives and manage drives compressed with DriveSpace or DoubleSpace. (You can even have drives of both compression types on your computer.)

When Windows 95 is installed, Setup replaces the DBLSPACE.BIN or DRVSPACE.BIN file in the root directory of the boot drive with versions that can be unloaded during the system startup process and replaced with DBLSPACX.VXD.

The version of DriveSpace provided with Windows 95 protects long filenames and includes other changes for compatibility with the VFAT file system.

This section presents an overview of CVFs and host drives, plus information about using DriveSpace for disk compression.

Overview of Compressed Volume Files and Host Drives

A compressed drive is not a real disk drive, although to most programs it appears to be. Instead, a compressed drive exists on the hard disk as a compressed volume file (CVF). A CVF is a file with read-only, hidden, and system attributes, and that contains a compressed drive. Each CVF is located on an uncompressed drive, which is referred to as the CVF's host drive. A CVF is stored in the root directory of its host drive and has a filename such as DRVSPACE.000 or DBLSPACE.000.

Most CVFs can store more data than the space they use on their host drives; for example, a typical CVF might use 100 MB of space on its host drive but contain 200 MB of compressed data. DriveSpace assigns a drive letter to the compressed volume so that you can use it as a disk drive and can access the files it contains. The host drive will have a separate drive letter (although it might be hidden).

Caution Do not tamper with a CVF. If you do, you might lose all the files on the compressed drive.

This following illustration shows the relationship between a compressed drive and a host drive (drive H), which is uncompressed. The `dir /c` command has been carried out on compressed drive C. This command lists the files in the current directory and displays the compression ratio of each file. The `dir /a` command has been carried out on drive H. This command lists the files in the current directory, including any files that have the hidden attribute. Drive H contains several files, including the compressed volume file for drive C, DBLSPACE.000.

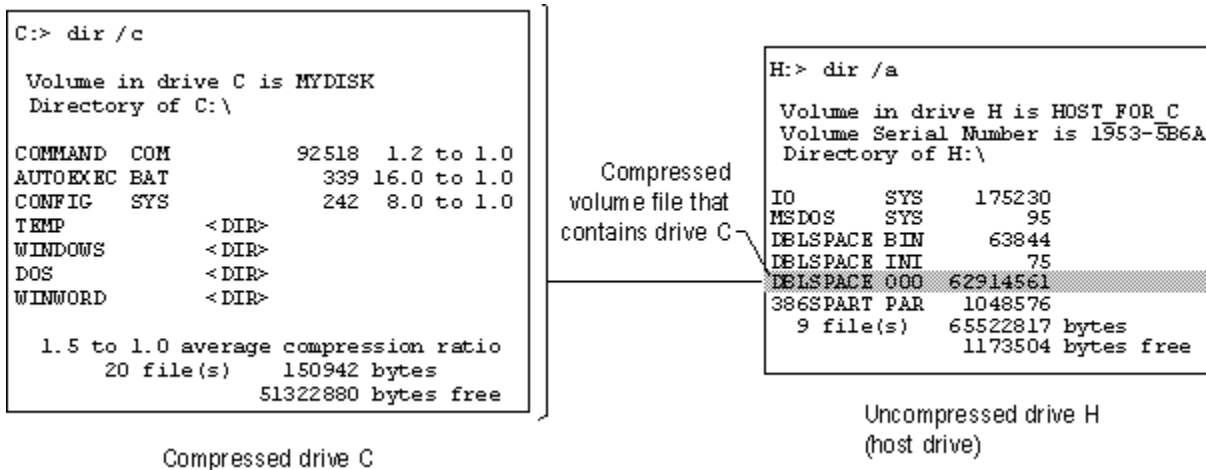

In this example, the CVF for drive C uses a substantial amount of space on drive H. However, drive C provides far more storage capacity than the space it uses on drive H.

Using DriveSpace for Disk Compression

Using DriveSpace, you can compress and uncompress data on floppy disks, removable media, or hard disk drives. DriveSpace frees space on disks by compressing the data or space the disks contain. The first time you use DriveSpace to compress data or space on a drive, the disk will have 50 to 100 percent more free space than it did before.

You can use a compressed drive just as you did before compressing it. In addition, DriveSpace creates a new uncompressed drive, called the host drive, where it stores the CVF. If the host drive contains any free space in addition to the CVF, you can also use it to store files that must remain uncompressed.

Note The version of DriveSpace included with Windows 95 can create a compressed drive of up to 512 MB. If your disk is very large, you might not be able to compress it as a single volume.

The version of DriveSpace available in Microsoft Plus! for Windows 95 can create a compressed drive of up to 2 GB, as described in [Microsoft Plus! Utilities for Disk Management](#).

You can also create a new compressed drive from the free space on an uncompressed drive that is part of a nonremovable hard disk. After compression, you'll notice that the uncompressed drive contains less free space than it did before. This space is now being used by the new compressed drive, which is stored in a hidden file with a filename such as DBLSPACE.001.

Consider this scenario: suppose you have a 200 MB hard disk with 100 MB of data on it. Uncompressed, this disk has 100 MB of free space. You can increase the amount of disk space in either of two ways:

- You can use DriveSpace to compress both the data and the free space on the disk. Then, because DriveSpace reports file sizes of compressed files as though they were uncompressed, you will see that the disk is now a 400 MB disk with 100 MB of data and 300 MB of free space.
- You create a new compressed drive from the hard disk's free space. DriveSpace will report that you have two drives, one with 200 MB of free space and the other with 100 MB of data and no free space. (You can also create an empty drive using only part of the available free space.)

Although the option to compress a drive provides more usable space, the process takes longer than creating a new compressed drive because DriveSpace has to compress the data on the drive.

Tip for Registry and Swap Files on Compressed Drives

The Registry can reside on compressed drives that were created by "preload" compression software such as Stacker 4.0, DoubleSpace, DriveSpace, and AddStor® SuperStor™/DS.

The swap file can reside on a compressed drive if a protected-mode driver (that is, DRVSPACE.VXD) controls the compressed drive. DriveSpace marks the swap file as uncompressible and, to reduce the amount of fragmentation, places the swap file as the last file in the CVF. Placing the file there also allows the swap file to expand.

If you want to change the size of the drive and if DriveSpace or a defragmentation utility detects a swap file at the end of the sector heap, you will be prompted to restart the computer.

If your swap file is on a compressed drive created by a real-mode compression drive, you should move the swap file to another drive, such as the host drive. For information about changing the location of your swap file, see [Performance Tuning](#).

Important Before you use DriveSpace to compress a drive, you should back up the files the drive contains.



To compress a drive

1. Click the Start button, click Run, and type **drvspace**
2. In DriveSpace, click the drive you want to compress.

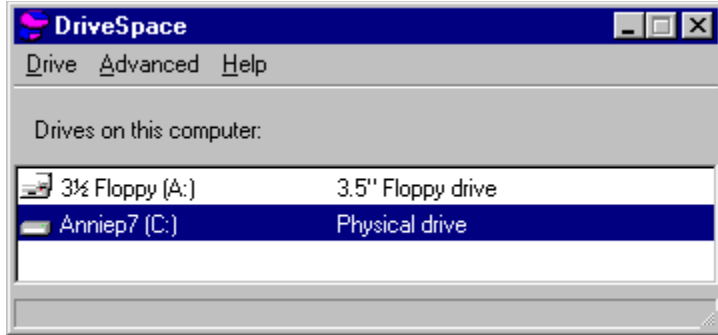

3. Click the Drive menu, and then click Compress.
The Compress A Drive dialog box appears, listing the drive it is about to compress.

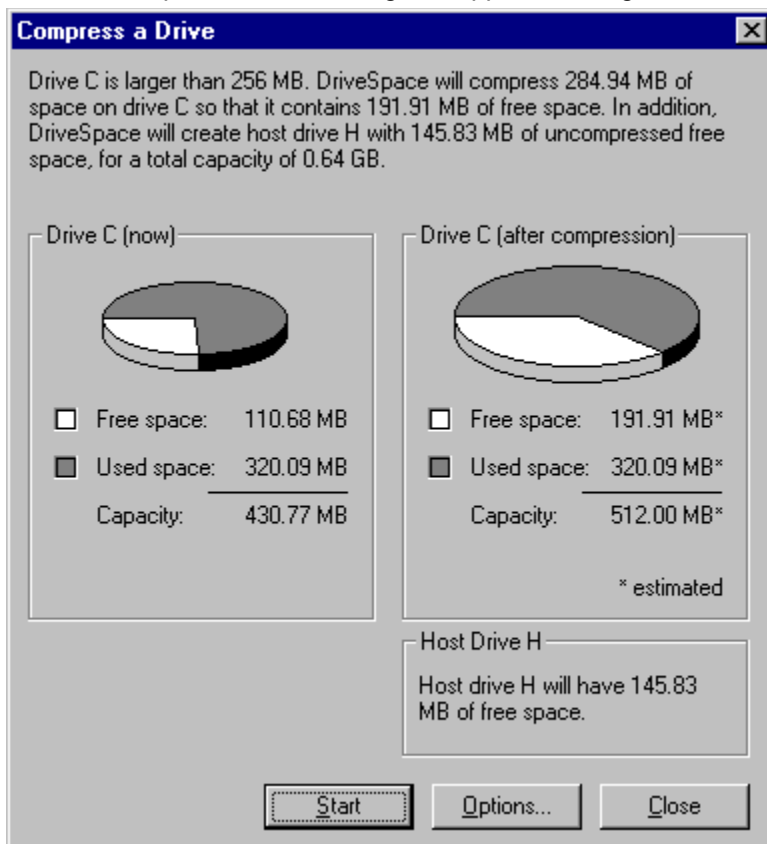

4. If you want to specify the drive letter or free space to leave available for the host drive, and whether the host will be hidden, click the Options button. Make modifications in the Compression Options dialog box as needed, and then click OK.

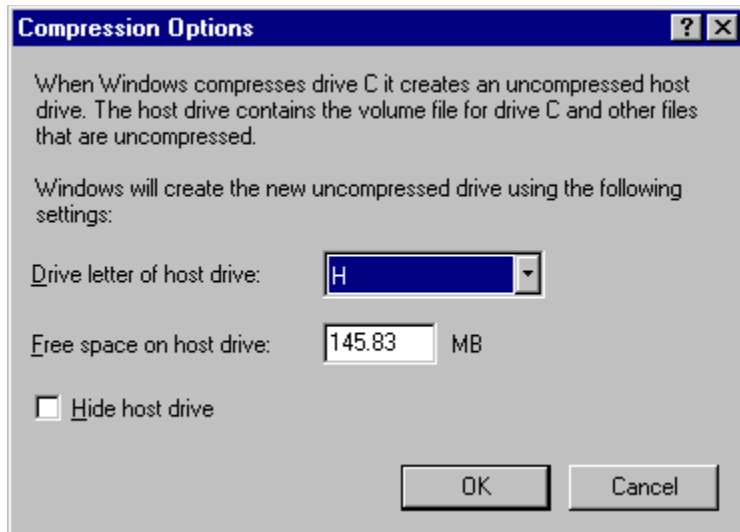

Note By default, DriveSpace hides the host drive if the amount of free space is less than 2 MB.

5. Click Start to continue.
6. DriveSpace prompts you to back up your files. If you want to back them up at this time, click the Back Up Files button.
7. To start compression, click the Compress Now button.

DriveSpace checks the drive for disk errors, and then it compresses the drive. This process can take from several minutes to several hours, depending on the speed of the hard disk and processor and on the amount of data the hard disk contains. Because DriveSpace checks and rechecks the validity of the data as it compresses files, the process is very safe. In fact, if the compression process is interrupted accidentally (for example, by a power outage), DriveSpace will recover and continue without losing any data.

If any files are open on the drive, DriveSpace will prompt you to close them. For drives that always have files opened (such as the drive containing Windows 95 or the drive containing a swap file), DriveSpace will restart the computer and use a limited version of Windows in place of Windows 95 while it compresses the drive. To do this, a directory named FAILSAVE.DRV is created that contains the system files required for this operation. After compression, your computer will restart again, this time with Windows 95. When the compression is completed, DriveSpace shows how much free space is available on the drive.



To create a new compressed drive

1. In DriveSpace, click the drive that has free space you want to use to create the new compressed drive.
2. Click the Advanced menu, and then click Create Empty.

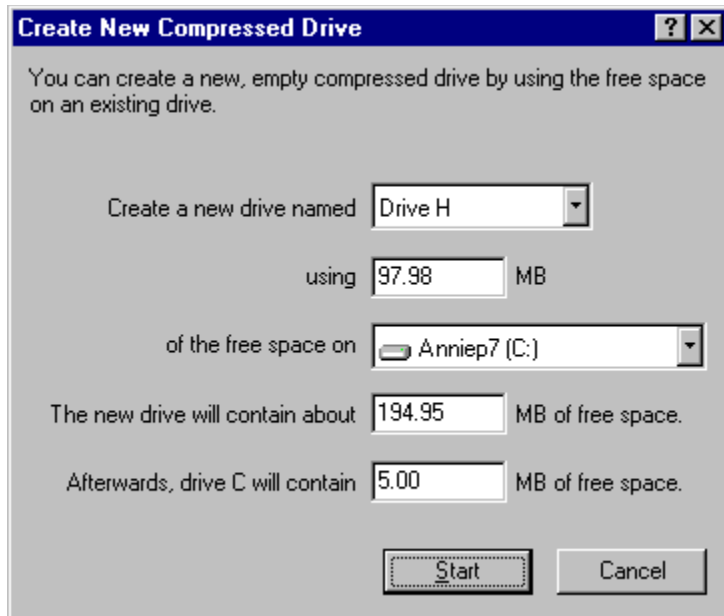

3. If you want to leave some free space on the original drive, decrease the value in the Using box.
4. To start compression, click the Start button.



To uncompress a drive

1. In DriveSpace, click a drive to uncompress.
2. Click the Drive menu, and then click Uncompress.

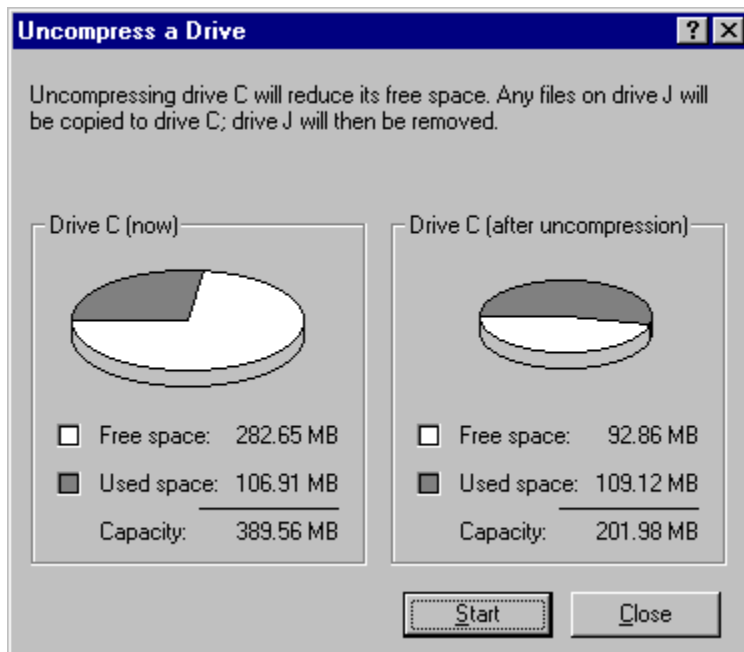

3. To start uncompressing, click the Start button.

If there isn't enough space on the host drive to contain the uncompressed files, DriveSpace displays a warning. Otherwise, DriveSpace prompts you to back up files and shows the status of the process as it progresses.

Note If you try to change the size of a drive that was mounted with a real-mode DriveSpace or

DoubleSpace driver, you will be prompted to restart the computer so that the drive can be remounted under Windows 95. This will also occur for other operations using the real-mode DriveSpace driver.

Using DriveSpace with Floppy Disks

You can use DriveSpace to increase the storage capacity of floppy disks. After compressing a floppy disk, you can use it to store data or to transfer data from one computer to another; both computers must be using Windows 95 DriveSpace or MS-DOS 6.x DoubleSpace.

After DriveSpace finishes compressing the floppy disk, the floppy disk contains more free space than it did before. You can use the floppy disk just as you did before compressing it.

Also, the computer has a new drive letter. This new drive letter represents the compressed floppy disk's host drive, which contains the floppy disk's CVF. Although both the new drive letter and the original drive letter refer to the same physical floppy disk drive, you can use only the original to access the disk drive.

In general, you use a compressed removable disk just as you do an uncompressed floppy disk. By default, DriveSpace automatically mounts a compressed floppy disk when you try to use that disk. This makes it possible to use the disk as if it were an uncompressed floppy disk.



To disable automounting

1. In DriveSpace, click the Advanced menu, and then click Settings.
2. Make sure the option named Automatically Mount New Compressed Devices is cleared, and then click OK.

Note Before it is mounted, a compressed floppy disk appears full. If you have disabled automounting, change to the floppy disk drive, and then type **dir**. The system usually lists only one file: a text file named READTHIS.TXT that briefly explains how to mount the floppy disk. The **dir** command usually reports that the floppy disk contains no free space because all the space is used by the CVF. The CVF is a file, usually named DBLSPACE.000, with hidden, read-only, and system attributes.

If automounting is disabled, you can still use compressed floppy disks, but you must mount them yourself.



To mount a compressed floppy disk in DriveSpace

1. Insert the compressed floppy disk in a drive.
2. In DriveSpace, click the drive you want to mount.
3. Click the Advanced menu, and then click Mount.

The compressed floppy disk remains mounted and the files on it remain available until you change floppy disks or restart the computer.

Changing Free Space and the Estimated Compression Ratio of a Compressed Drive

On an uncompressed drive, free space indicates how much additional data you can store on that drive. For example, if a drive has 2 MB of free space, you can expect to fit 2 MB of data on it. However, the free space on a compressed drive is only an estimate of how much data you can fit on that drive.

When you store a file on a compressed drive, DriveSpace compresses the file so that it takes up as little space as possible. Some files can be compressed more than others; for example, a bitmap file can be compressed much more than a program file. DriveSpace cannot detect the compressibility of files you haven't stored yet, so it only estimates a compressed drive's free space.

DriveSpace estimates a drive's free space by using the *estimated compression ratio*, which you can set to specify the compressibility of the files you plan to store. For example, if the estimated compression ratio is 3 to 1, DriveSpace calculates the drive's free space based on the assumption that each file to be stored can be compressed to one-third its original size.

Usually, the best compression estimate to use is the actual compression ratio for the files already stored on the drive. Sometimes you might want to reset the estimated compression ratio of each drive to match that drive's actual compression ratio.

You might want to change the estimated compression ratio if it differs greatly from the actual compressibility of the files to be stored. For example, if you plan to store extremely compressible files, such as bitmap files, you might want to specify a higher estimated compression ratio.

Changing a drive's estimated compression ratio does not affect how much DriveSpace actually compresses the files on that drive; it changes only the way DriveSpace estimates the free space on the compressed drive.



To change the estimated compression ratio

1. In DriveSpace, click the compressed drive you want to change.
2. Click the Advanced menu, and then click Change Ratio.
3. In the Compression Ratios area, type a new ratio box or drag the slider to the desired ratio. Click OK.

You can also adjust the amount of free space for a compressed drive or its host drive. This is equivalent to changing the size of the compressed drive and its CVF. When you increase free space on a compressed drive, you decrease it on its host, and vice versa.



To change the amount of free space on a drive

1. In DriveSpace, click the drive on which you want to change the amount of free space.
2. Click the Drive menu, and then click Adjust Free Space.
3. In the Adjust Free Space dialog box, type a new value or use the slider to adjust the amount of free space available on the compressed and host drives. Click OK.

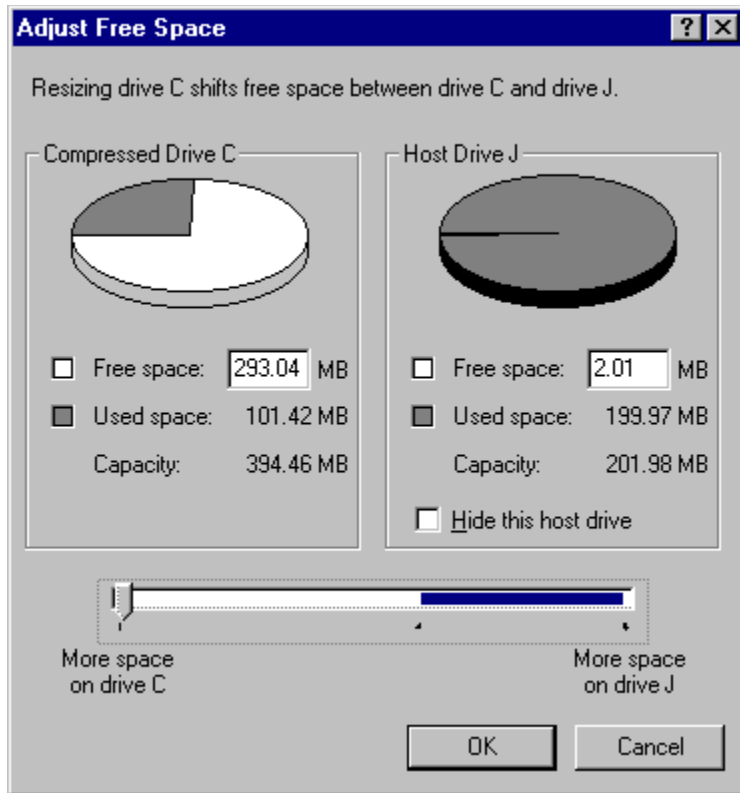

Tip If the free space is highly fragmented, the usable free space might be less than what DriveSpace estimates. In some cases, you might not be able to store files on that drive, even though there appears to be plenty of space. To avoid this problem, run Disk Defragmenter regularly on compressed drives.

Microsoft Plus! Utilities for Disk Management

Microsoft Plus! for Windows 95 provides the following additional capabilities for managing a computer running Windows 95:

- Enhancements to DriveSpace for higher compression ratios, support for creating compressed drives that are 2 GB in size, and compression information as part of drive and folder properties. To achieve greater performance and compression benefits, the Microsoft Plus! compression manager provides a new CVF format (DriveSpace 3).
- Compression Agent, a recompression utility that can run when your computer is idle to maximize the compression of files. With Compression Agent, the whole drive or designated files can be compressed when no other work is being done on the computer, rather than compressing files as they are saved during a work session. Compression Agent also allows you to designate different compression methods for different files and offers the UltraPack encoding format, a new method for achieving maximum compression.
- System Agent, a general-purpose scheduling program that comes preconfigured to maintain the computer's hard disks by running programs such as ScanDisk or Compression Agent at scheduled times. You can also use System Agent to schedule programs to run at specified intervals.

Microsoft Plus! for Windows 95 also includes features such as font smoothing, animated cursors, a set of themes for personalizing your computer, and more. For information about the dial-up networking server provided with Microsoft Plus!, see [Dial-Up Networking and Mobile Computing](#).

Microsoft Plus! for Windows 95 is available as a retail product. Some computer equipment manufacturers might also include these utilities as part of the software provided with the computer. If these utilities were not provided on your computer, contact your software vendor about obtaining this product.

The following sections present some technical details about these additional disk management utilities. For information about installing, configuring, and using the utilities, see the Microsoft Plus! documentation (*Introducing Microsoft Plus!*) and online Help for each program.

Disks and File Systems

Microsoft Plus! Utilities for Disk Management

DriveSpace 3 Compression: An Overview

The new compression manager provided with Microsoft Plus! contains several enhancements over Windows 95 DriveSpace. These enhancements include the following:

- Enhanced compression with support for compressed drives up to 2 GB (earlier versions support volumes of up to 512 MB), using a 32K cluster size (earlier versions use 8K clusters)
- Support for storing compressed data for a cluster in multiple fragments when there are not enough continuous sectors on the disk to store the entire cluster
- Compression is up to 20 percent faster than standard Windows 95 compression on Pentium™-based computers. Other x86-based computers should also run faster with DriveSpace 3 when the compression is configured for best performance.

As with earlier CVF versions, a DriveSpace 3 CVF has a name in the form DRVSPACE.*nnn*, where *nnn* is the CVF sequence number in the range 000 through 254.

Disks and File Systems

Microsoft Plus! Utilities for Disk Management

DriveSpace 3 Compression: An Overview

DriveSpace and Disk Properties Enhancements

Microsoft Plus! adds the following features to Windows 95 DriveSpace:

- New DriveSpace settings for specifying whether to use compression, what type of compression to use, and how to use it.
- Support for compression enhancements on existing drives. You can upgrade existing DbISpace or DrvSpace drives to the Microsoft Plus! DriveSpace 3 format.

Microsoft Plus! also places drive-specific compression information (and the tools to manipulate it) where you would expect to find it: in the drive's properties. (System-wide compression settings and functions are still available in the DriveSpace programs.) To present this information, a Compression tab is added to the property dialog boxes for all local hard and floppy disk drives, except compressed drives created by software from other vendors. Uncompressed drives that are hosts for one or more compressed volume files also have a Compression tab added to their properties. For hidden host drives, you must use the DriveSpace program to view information about the drive.

Disks and File Systems

Microsoft Plus! Utilities for Disk Management

DriveSpace 3 Compression: An Overview

How Compression Works with DriveSpace 3

Microsoft Plus! achieves a higher compression ratio by compressing data in 32K blocks (instead of 8K blocks used for DblSpace or DrvSpace), and by supporting two new levels of compression: HiPack and UltraPack.

HiPack compression uses the same encoding format as standard compression, but searches the entire history buffer for matches instead of being limited to a history window.

UltraPack compression uses a different encoding format. UltraPack format offers better compression than standard or HiPack compression, but files compressed in UltraPack format are also slower to decompress. UltraPack compression is available only by running Compression Agent. You cannot configure DriveSpace to save files in UltraPack format automatically.

Because the new UltraPack encoding format used DriveSpace 3 CVFs, the Microsoft Plus! DRVSPACE.BIN and DRVSPACX.VXD must be installed to read these CVFs.

Microsoft Plus! compression can also store more data on the disk than with standard DriveSpace compression because of improved fragmentation handling. With standard DrvSpace or DblSpace CVFs, the data for a cluster must be stored in contiguous sectors. When the volume is highly fragmented, it is possible to have many free sectors but not enough contiguous sectors to store a cluster (which can require up to 16 sectors on a DblSpace or DrvSpace CVF, and up to 64 sectors on a DriveSpace 3 CVF). Microsoft Plus! compression avoids this problem by storing data for a fragmented cluster in a linked list of sectors when there are not enough continuous sectors to store the entire cluster. Microsoft Plus! compression also stores small directories in a single sector, whereas MS-DOS 6.x or Windows 95 require 16 sectors.

Using Compression Agent

Compression Agent allows you make the following choices for compression methods:

- Whether specified files should be in UltraPack format, and whether to downgrade a file from UltraPack format
- Whether individual files, folders, or file types should be compressed and, if so, with what method
- Whether to use compression for the rest of your files and, if so, which type

You can start Compression Agent manually or, more commonly, you can have System Agent start it automatically when the computer is idle or at any time you specify. Compression Agent uses the Windows 95 Last Access Date to determine which files have not been used within a defined time (but Compression Agent does not modify the Last Access Date for any files).

The compression policies specified in the Compression Agent Settings dialog box control the standard policy used to compress files. However, you can also force or prevent a particular compression type on a particular file, or set of files, or folders, based on the following exceptions to the standard compression policy:

- Never compress
- Always compress with UltraPack format
- Always compress with HiPack format

The following shows the Compression Agent command line syntax:

cmpagent [*drive:* | **/all**] [**/noprompt**]

The following table describes the parameters for this command.

Parameter	Description
<i>drive:</i>	Specifies drive to be recompressed.
/all	Specifies all local, fixed drives that are compressed.
/noprompt	Runs without waiting for the user to click Start, and without displaying a summary at the end. Errors are displayed. This switch can be shortened as /nop .

Guidelines for Fine-tuning Compression

Typically, you will want to use the default values for Microsoft Plus! compression, which specify using standard or no compression when saving files. You can then set System Agent to run Compression Agent when the computer isn't busy to compress seldom-used files into UltraPack format and all other files into HiPack format.

When you are deciding what methods and formats to use for compression, you must consider whether you want to configure compression to ensure maximum disk space or maximum system performance.

Maximizing hard disk space.

If you require that compression provide maximum disk space on a computer, then you might want to specify that UltraPack format be used to compress most files. (UltraPack format is recommended for Pentium-based computers.) In addition, you can specify that files be compressed as they are saved. If your computer is very fast, specify that HiPack format be used.

Maximizing performance.

If you require maximum system performance, remember that files compressed in UltraPack format are much slower to decompress, so that if you try to access a document or run an application that is compressed in UltraPack format, you might have to wait before you can begin working again. For

slower computers that require maximum performance, you can use System Agent and Compression Agent to specify that all compression is done while the computer is idle instead of compressing the files as they are saved. This provides the benefits of compression without any performance impact related to updating files.

To ensure maximum performance, you might want to define the following when configuring compression:

- Use DriveSpace to specify that compression only occurs offline, not when each file is being saved, or specify that compression occurs only when disk space is low.
- Specify a high threshold for UltraPack, so that, for example, Compression Agent recompresses in UltraPack format only those files that haven't been accessed within 30 or more days.
- Set exceptions for files that should not be compressed in UltraPack format, such as executable files that you do not want to wait to have decompressed, even though you seldom use the files.

Notice that if you configure DriveSpace not to compress files as they are saved, or to compress files only when free space is low (using the Depends On Free Space option), the system reports free space as though files will not be compressed. As a result, the computer appears to have significantly less free space than it does when files are compressed as they are saved. However, if you use Compression Agent regularly, you will be able to store the same amount of data in this space.

Disks and File Systems

Microsoft Plus! Utilities for Disk Management

Scheduling Programs with System Agent

System Agent is a Win32-based application for scheduling programs to run at times you specify. After it is installed and configured on a computer, System Agent periodically runs programs according to your preferences. System Agent supports options for specifying when Compression Agent, Disk Defragmenter, ScanDisk, and other programs will run, and it provides notification of exceptional conditions such as low disk space.

Programs can be scheduled to run based on several criteria, such as the exact time and date, or a range of times, or whether the computer is idle or is running on batteries.

Disks and File Systems

Microsoft Plus! Utilities for Disk Management

Scheduling Programs with System Agent

How System Agent Works

System Agent consists of two parts, a scheduling engine (SAGE.EXE) and a separate application (SYSAGENT.EXE) for displaying and modifying the list of scheduled programs. The list of scheduled programs for System Agent is stored in the SAGE.DAT file, which is placed by default on the user's computer in the SYSTEM subdirectory of the folder where Microsoft Plus! is installed. However, this file can also be stored in a network directory. The **ConfigPath** value in the following Registry key defines the location of SAGE.DAT:

```
Hkey_Local_Machine\Software\Microsoft\Plus!\System Agent
```

The System Agent scheduling engine is a system service that runs continuously, monitoring the system and starting programs according to a database that contains the schedule you define for programs to be run. The only way you can interact with SAGE.EXE is by using the System Agent application.

The scheduling service starts automatically when the computer starts because its Setup program adds **sage.exe** as a value under the following Registry key:

```
Hkey_Local_Machine\Software\Microsoft\Windows\CurrentVersion\Run
```

You can quit SAGE.EXE if required — for example, if a setup program such as Windows 95 Setup prompts you to quit all applications before running — by choosing a command in the System Agent application.



To quit SAGE.EXE (the System Agent scheduling engine)

- In the System Agent application click the Advanced menu, and then click Stop Using System Agent.

Note Removing the System Agent scheduling engine in this way completely removes both SAGE.EXE and SYSAGENT.EXE from memory and from the Registry. Consequently, System Agent will not start automatically, and scheduled programs will not be run.

To restore System Agent as an automatic service, run the System Agent application, and answer Yes when prompted to start SAGE.EXE.

System Agent also notifies you when the following events occur:

- Disk space falls below a predefined threshold
- System Agent fails to run a program at its scheduled time because the computer was not running, was running on batteries, or was otherwise not idle
- A DbfSpace or DrvSpace Cvf needs to be upgraded to DriveSpace 3

Note When Microsoft Plus! is installed, the ScanDisk and Defrag tools are enhanced to support DriveSpace 3 compression.

Upgrade notification (UPGRDALM.EXE) is scheduled to run when the computer first starts after Microsoft Plus! Setup. If there are no compressed drives to be upgraded, this notification is removed from the System Agent schedule and never runs again. If you choose to upgrade, the notification runs DriveSpace 3, and then removes itself from the System Agent schedule when it has confirmed that the drives have been upgraded or compressed.

Note The Upgrade notification runs by default at system startup although it doesn't appear in the list of programs scheduled in System Agent. For the Upgrade notification to appear in System Agent, change the **ShowSystemTasks** string value to **1** in the following Registry key:

```
Hkey_Current_User\Software\Microsoft\Plus!\System Agent
```

Disks and File Systems

Microsoft Plus! Utilities for Disk Management

Scheduling Programs with System Agent

Running Other Programs with System Agent: An Overview

In addition to the disk utilities such as ScanDisk or Compression Agent that can be scheduled to run with System Agent, you can use System Agent to schedule any kind of program that you want to run at a particular time or periodically. For example, you might use System Agent to do the following:

- Dial in to an online service during off-peak hours, look for certain topics, download the results, and hang up.
- Run a spreadsheet application such as Microsoft Excel, and use one or more macros to perform extensive computations on worksheets.
- Run backup software when the computer is not being used.

The methods you use for scheduling and running a program depend on whether the application was designed to work with System Agent.

If the program is designed to run with System Agent, you can use the Settings dialog box in System Agent to choose options to use when running the program. For example, you might designate that ScanDisk run a standard test nightly, but run a thorough test once a month. A System Agent-aware program might offer additional options to choose for running the program.

For all types of programs, you can define a command line for running the program. This command line can be one of the following:

- Any command-line statements that the program accepts. This might include only the program's executable name, the program name and a macro name or target filename, or the program name and any command-line switches.
- A batch file with any allowable actions. If you use a batch file, you can simulate a chained group of commands for running multiple programs or batch files. To do this, use the **start /W** command in the batch file, which starts a program and waits for the results before running the next statement in the batch file.

The general process for scheduling a program to run in System Agent includes the following basic steps:

1. Select the Schedule A New Program command in System Agent, and specify a program to schedule. This is where you can specify the command-line switches or a batch file to run (for a program that is not System Agent-aware).
2. Optionally, define a friendly name for the program.
3. Optionally, for System Agent-aware programs such as ScanDisk or Compression Agent, click the Settings button and define the options for running the program.
4. Click the When To Run button and specify the interval at which the program will run, such as daily, weekly, or monthly.

File Systems Overview

With the Windows 95 installable file system, multiple file systems can coexist on the computer. Windows 95 includes the following file systems.

VFAT.

In Windows 95, the 32-bit virtual File Allocation Table file system is the primary file system and cannot be disabled. VFAT can use 32-bit, protected-mode drivers or 16-bit real-mode drivers. Actual allocation on disk is still 12-bit or 16-bit (depending on the size of the volume), so FAT on the disk uses the same structure as previous versions of this file system. VFAT handles all hard disk drive requests, using 32-bit code for all file access for hard-disk volumes. VFAT was first introduced in Windows for Workgroups version 3.11 as an optional FAT file system that processed file I/O in protected mode.

Network redirectors.

A network redirector (such as Microsoft Client for NetWare Networks or Client for Microsoft Networks) is a file system driver that accesses the network file system. Windows 95 supports multiple network redirectors simultaneously, as described in [Windows 95 Network Architecture](#).

CDFS.

The virtual CD-ROM file system has the same responsibilities for a CD-ROM device as VFAT has for a standard hard disk. If a CD-ROM device is detected, the CDFS driver loads dynamically. When CDFS is installed, the standard disk type-specific device and Disk SCSI translator are replaced with CD-ROM versions. The CDFS driver is a protected-mode version of MSCDEX.EXE, providing the interface from the CD-ROM device to the operating system, as described in [VCACHE and CDFS Supplemental Cache](#) and in [Windows 95 Architecture](#).

If the CD-ROM drive and its drivers support the multisession command, CDFS can support multisession capabilities, which provide a method for adding data to a CD-ROM (this is most applicable to CD-Recordable media). The multisession command returns a number that identifies the first sector of the last session on the media so that CDFS can recognize the media.

All these file systems support long filenames and can use the protected-mode cache (VCACHE) for read-ahead. VFAT also supports lazy-write throughput, so applications can write immediately to the cache, and VFAT can write the information to disk later. For more information, see [VCACHE and CDFS Supplemental Cache](#).

Other software vendors can also implement file systems. For example, a vendor might provide a file system that allows a computer running Windows 95 to connect to a different operating system (for example, Apple® Macintosh® or UNIX®) to share files.

The Installable File System Manager (IFSMGR) receives all INT 21 calls and determines which file system driver should receive the call to process it. IFSMGR uses a real-mode stub named IFSHLP.SYS to send INT 21 calls back to IFSMGR, as described in [Windows 95 Architecture](#).

File system drivers manage the high-level I/O requests from applications. The file system driver processes requests from applications and initiates low-level I/O requests through the I/O Supervisor.

Protected-mode disk compression is not integrated into the file system, but is supported by a layer in the I/O subsystem. Windows 95 supports disk compression software created for earlier versions of MS-DOS, using their real-mode driver loaded from CONFIG.SYS.

Using Long Filenames

For MS-DOS version 6.22 and earlier, filenames cannot exceed eight characters and filename extensions cannot exceed three characters in length (referred to as “8.3 filenames”). The period character (.) is used only to separate the filename from the filename extension. With long filename support in Windows 95, these 8.3 filename constraints are gone.

For all Windows 95 file systems, users can specify filenames that are up to 255 characters long and that can contain more than one period. These long filenames are any names that exceed 8.3 characters in length or contain any lowercase character or any character that is not valid in the 8.3 name space.

The following sections present information about long-filename support in Windows 95, including information and recommendations for supporting long filenames in a mixed network environment.

Long Filename Support in Windows 95

For every long filename, an alias entry is generated automatically that complies with the 8.3 filename rules for backward compatibility. Automatically generated aliases are composed of the first six characters of the filename plus ~*n* (where *n* is a number) and the first three characters after the last period. So the filename ThisIsALong.File.Name is associated with the automatically generated alias THISIS~1.NAM. If the alias name already exists, the algorithm increments *n*, where *n* begins with 2 until the system can find a unique filename.

Note Neither the user nor an application can control the name created by the automatic alias process. Related issues are discussed in [Long Filenames and Network Compatibility](#).

For the filename to comply with the 8.3 filename rules, it must use only the valid characters for an alias and it must be all uppercase. Short filenames are converted to uppercase by the IFSMGR before being passed to the file system driver. Valid characters for 8.3 filenames (and aliases) can be any combination of letters and numbers, a blank (ASCII 20H), ASCII characters greater than 127, and the following special characters:

\$ % ' - _ @ ~ ` ! () ^ # &

The following additional characters are valid in long filenames, but are not valid in alias names or 8.3 filenames:

+ , ; = []

The following rules also apply for Windows 95 file systems:

- Maximum filename component length is 255 characters, including NULL
- Maximum path length is 260 characters, including NULL (compared to 80 characters for a short name)
- The OEM character set can be specified by an application if the application is written for that character set
- The long-filename directory entries use the Unicode character set to store the names

The filename and the alias are the same if the filename meets 8.3-filename rules (that is, if it contains only valid characters for an alias and it is all uppercase). This means that a filename using only valid characters for an alias and following the 8.3-filename format is still not the same as the alias name if it contains lowercase characters. However, in this case the alias is the uppercase version of the filename. For example, if the long filename is Examples.Txt, its alias is EXAMPLES.TXT. The case is preserved in the long filename. (Notice, though, that searches in the Windows 95 file system are not case-sensitive. So a search of the form "examples.txt" or "Examples.Txt" will find the same files.)

Tip To see the alias for a file, right-click the file in any shell program such as Windows Explorer and then select Properties from the context menu. The value for MS-DOS Name in the General properties dialog box shows the alias assigned to this file. Also, the **dir** command at the command prompt shows the long filename.

Long Filenames and Network Compatibility

By using a process called *tunneling*, Windows 95 preserves long filenames for files that are opened and saved using an application that does not recognize long filenames. Tunneling preserves long filenames on the local computer as well as files accessed across the network.

Tunneling is supported for any file system that IFSMGR recognizes. The file system in turn must “authorize” tunneling to allow its use in that file system. Tunneling is authorized automatically with VFAT.

Correct network tunneling is the responsibility of the server — that is, the server must be configured to support long filenames. A server running any edition of Windows NT 3.5 or Windows 95 file and printer sharing services will preserve long filenames. For example, a user who is running Windows for Workgroups might open and save a file on a peer server that is running file and printer sharing services (for either Microsoft networks or NetWare networks). In this case, the long filename will be preserved by the file system on the peer server, because the peer server uses IFSMGR and VFAT to store the data.

- NTFS, the Windows NT file system, supports long filenames, but includes architecture for security that Windows 95 does not use. Windows NT 3.5 supports long filenames on FAT drives and uses the same algorithm for aliases as used in Windows 95. However, Windows NT 3.1 doesn't recognize long filenames on FAT drives and removes them.
- HPFS file system supports long filenames with aliases similar to the method used in Windows 95.
- CDFS, the CD-ROM file system, also supports long filenames.

The following sections provide details about long filename support on various networks.

Disks and File Systems

Using Long Filenames

Long Filenames and Network Compatibility

Long Filenames with Windows 95 Protected-Mode Clients

Windows 95 protected-mode network clients (Client for Microsoft Networks and Client for NetWare Networks) support long filenames. If the network server that the computer is connected to supports long filenames, then Windows 95 can read, create, and copy local long-filename files on the network share. On some servers, the length of filenames, restricted characters, and the algorithm for creating 8.3 filenames from long filenames might differ from those under Windows 95.

Client for Microsoft Networks does not authorize tunneling, so tunneling is not used to preserve long filenames on down-level servers connected through the Windows 95 client (for example, a computer running Windows for Workgroups or LAN Manager Services). However, Microsoft Client for NetWare Networks does authorize tunneling, so tunneling can preserve long filenames in connections to older NetWare servers when running Client for NetWare Networks.

Windows 95 can access files on HPFS or NTFS partitions on remote drives. However, there is no built-in support in the release of Windows 95 for adding either of these file systems as another installable file system under Windows 95. Therefore, Windows 95 cannot access either an HPFS or NTFS partition on a local disk drive by using the file system drivers provided with Windows 95. (Other vendors, however, can add HPFS support.)

Please note the following interoperability exceptions for other file systems:

Long filenames can be used on computers running file and printer sharing services and can be viewed on computers using protected-mode Windows 95 network clients. Real-mode network clients running under Windows 95 can see only the 8.3 filename aliases.

If Windows 95 has been configured with File and Printer Sharing for NetWare Networks, any MS-DOS-based NetWare clients using NETX or VLM will see 8.3 filenames computers using Client for NetWare Networks can see long filenames.

Long filenames are supported for NetWare servers if the server is configured to use the OS/2 name space. For information, see [Windows 95 on NetWare Networks](#).

Note Older Microsoft or Microsoft-compatible clients (for example, LAN Manager, Workgroup Add-on for MS-DOS, Windows for Workgroups, and so on) cannot use shared folders that have long filenames. These older network clients might have problems connecting to and using a shared directory with a long filename as the directory name. Defining a short share name does not correct this problem.

Disks and File Systems

Using Long Filenames

Long Filenames and Network Compatibility

LAN Manager with HPFS and HPFS/386 Volumes

HPFS and HPFS/386 partitions on LAN Manager OS/2-based computers have a maximum filename length of 254 characters and use the 8.3 filename alias on the first instance. For example:

```
longfilenameold.tst --> LONGFILE.TST  
longfilenamew.tst --> LONGFIL0.TST
```

Long filenames on a LAN Manager server with HPFS or HPFS/386 partitions are supported and viewable by Windows 95 protected-mode network clients. Real-mode network clients can see only the 8.3 filename aliases.

LAN Manager workstations with HPFS or HPFS/386 cannot see Windows 95 long filenames. The LAN Manager workstation software has no awareness of the long filename-over-FAT file scheme used by Windows 95.

Disks and File Systems

Using Long Filenames

Long Filenames and Network Compatibility

Windows NT 3.1 with HPFS or NTFS Volumes

Support for long filenames on FAT volumes is identical in Windows NT 3.5 and Windows 95. Therefore, a computer with dual-boot capabilities for Windows NT 3.5 and Windows 95 can see long filenames on local FAT volumes by using both operating systems.

HPFS partitions exist on Windows NT computers only in the case of an upgrade over OS/2. Filenames on Windows NT 3.1 HPFS partitions have a maximum filename length of 254 characters and use the 8.3 filename alias on the first instance. For example:

```
longfilenameold.tst --> LONGFILE.TST  
longfilenamew.tst --> LONGFIL0.TST
```

Filenames on Windows NT 3.1 NTFS partitions have a maximum filename length of 255 characters and use the 8.3 filename alias on the first instance. For example:

```
longfilenameold.tst --> LONGFI~1.TST  
longfilenamew.tst --> LONGFI~2.TST
```

Long filenames on shared Windows NT 3.1 HPFS and NTFS partitions are supported and viewable by Windows 95 protected-mode network clients. Real-mode network clients can see only the 8.3 filename aliases.

Windows NT 3.1 computers cannot see Windows 95 long filenames. Windows NT 3.1 has no awareness of the long filename-over-FAT file scheme used by Windows 95.

Administrative Considerations for Long Filenames

If you are supporting long filenames at a site with many users, the following issues must be considered:

- If you back up files to a server that does not support Windows 95 long filenames, use the LFNBK utility to save and restore long filenames. For information, see [Using the LFNBK Utility for Temporary Compatibility](#).
- Be aware of utilities that will not work with the new Windows 95 directory entries for long filenames. Some virus scanning programs, disk repair utilities, disk optimizers, and other programs depend on the FAT file system and might not work with long filenames. If you are unsure whether a utility is compatible with the long filename system, check with the manufacturer. If you must use an incompatible program, be sure to turn off long filenames by using the LFNBK utility before proceeding.
- Do not use filenames that are more than 50 to 75 characters long. Although filenames can be up to 255 characters, the full path name cannot be more than 260 characters. To save room for moving a file from one directory to another, use filenames shorter than the limit. Besides, filenames that are too long can make browsing a list difficult.
- Publish a naming convention for your site so that users are aware of naming considerations and can prevent problems with the long filenames they use. For example, your policy could recommend making the first three or four letters significant, so that the 8.3 filename aliases can be distinguished from each other. The following example shows the alias names for some long filenames:

```
Status Report for Oct -> STATUS~1.TXT  
Status Report for Nov -> STATUS~2.TXT  
Status Report for Dec -> STATUS~3.TXT
```

Using the following alternate filenames, you can distinguish between the 8.3 filenames:

```
Oct Status Report -> OCTSTA~1.TXT  
Nov Status Report -> NOVSTA~1.TXT  
Dec Status Report -> DECSTA~1.TXT
```

You could also recommend that users give files a short filename as part of the long filename. For example:

```
Mktg_rpt-Marketing Report for our new project -> MKTG_R~1.TXT
```

As part of the naming convention, recommend that users check the properties for files to ensure that the alias (the MS-DOS Name in the properties dialog box) is what they expect it to be.

Tip for Long Filenames in the Root Directory

Usually, it is best to store files in a directory beneath the root directory. This is especially true for files with long filenames. Files with long filenames use more directory entries than files with 8.3 filenames. Because the number of entries in the root is limited to 512, the root directory can fill up with fewer files if long filenames are used.

Notice that typing the command **mkdir Examples** creates a long filename directory entry that contains the name Examples to preserve the case, plus an 8.3 filename alias entry with the name EXAMPLES for compatibility. In this example, two directory entries are used.

Most hard disk utility programs released before Windows 95 require updating to work correctly with Windows 95. If you use a hard disk utility that was not created especially for use with Windows 95, you

might lose long filenames and you are at risk of losing data. Examples of such programs include the following:

- Norton Utilities® by Peter Norton Computing
- PC Tools™ by Central Point Software, Inc.
- Microsoft Defragmenter for MS-DOS version 6.0, 6.2, 6.21, or 6.22
- Stacker 4.0 by STAC Electronics

In special cases, you might need to run backup or disk management utilities created for older versions of Windows or MS-DOS that are not compatible with the extended file system capabilities of Windows 95. Or you might need occasionally to run an application that is not compatible with long filenames. In such cases, you can use the LFNBK utility to remove (and later restore) long filenames on a disk.



To install the LFNBK utility

- From the Windows 95 compact disc, copy LFNBK.EXE to the Windows directory on your computer.

Caution The LFNBK utility is intended for use only by experienced Windows 95 users with special needs for compatibility with older disk utilities. It is not intended for everyday use by average users.

Microsoft recommends that users rely on the disk management utilities included with Windows 95 or use Windows 95-compatible utilities from other vendors, rather than attempting to use older utilities that are not compatible with Windows 95.

Notice also that the DriveSpace utility included with Windows 95 is compatible with long filenames and can be used without LFNBK to manage compressed disks created with older versions of DriveSpace or DoubleSpace.

The following shows the syntax for LFNBK:

lfnbk [/v] [/b | /r | /pe] [/nt] [/force] [/p] [drive]

The following table lists and describes the parameters for this command.

Parameter	Description
/v	Reports actions on the screen.
/b	Backs up and removes long filenames on the disk.
/r	Restores previously backed-up long filenames.
/pe	Extracts errors from backup database.
/nt	Does not restore backup dates and times.
/force	Forces LFNBK to run, even in unsafe conditions.
/p	Finds long filenames, but does not convert them to 8.3 filename aliases. This reports the existing long filenames, along with the associated dates for file creation, last access, and last modification of the file.



To preserve long filenames with disk utilities that do not recognize them

1. Turn off tunneling.
To do this, in the System option in Control Panel, click the Performance tab, and then click File System. In the File System Performance dialog box, click the Troubleshooting tab, and check the option named Disable Long Name Preservation for Old Programs.
2. Close all other applications. LFNBK cannot rename open files.
3. At the command prompt, type **lfnbk /b** [drive] to back up and remove long filenames.
4. Restart the computer, and then run the disk utility. If it is an MS-DOS-based utility, run it in MS-DOS Mode. For a Windows-based utility, run it in the usual way.
5. Turn tunneling on again, and then restart the computer.
6. At the command prompt, type **lfnbk /r** [drive] to restore long filenames.

The LFNBK utility actually renames each file with a long filename to its associated alias. The filename

changes are stored in the LFNBK.DAT file in the root of the drive where you are running LFNBK. This file is used to restore long filenames (when you run LFNBK with the */r* switch).

The following list provides some brief notes for using the LFNBK utility:

- You cannot use LFNBK to repair long filename problems.
- LFNBK might not be able to rename files with exact matches to long-filename aliases, and the related alias is not guaranteed to be the same as before running LFNBK.
- After you run LFNBK and then restart Windows 95, the default Start menu will appear, rather than your custom Start menu. After you run **lfnbk /r** to restore long filenames, your custom Start menu will also be restored.
- If the directory structure changes after you run **lfnbk /b**, then long filenames cannot be restored with **lfnbk /r**. For example, if you run a disk utility that prunes or removes subdirectories, LFNBK cannot restore the long filenames within those subdirectories.

Disks and File Systems

Using Long Filenames

Administrative Considerations for Long Filenames

Creating Long Filenames at the MS-DOS Prompt

At an MS-DOS prompt or when Windows 95 is started only at the command prompt (from the F8 Startup menu), the keyboard buffer's ability to create long filenames is limited to 127 characters. This is because the default command-line character limitation is 127 characters. In the default configuration, the MS-DOS environment will not allow more than 127 characters in a given command line. (However, in batch files, or for environment variables and other VM elements, the long filename support is 244 characters.)

You can increase the global command-line character limit for the keyboard buffer to its maximum by placing the following line in CONFIG.SYS:

```
shell=c:\windows\command.com /u:255
```

If the **shell** command is already present with the **/u** switch, increase the value to 255.

This command will affect all VMs and the Windows 95 command line.

With the command-line character limit set to its maximum of 255 characters, filenames are limited to 255 characters minus the contents of the command line. For example, the command line might contain the following:

```
copy con "long filename"
```

In this case, the maximum length of the long filename is 244 characters (255 minus the 11 characters of the command).

Note It is necessary to put the filename in quotation marks on the command line only if the filename contains special characters such as spaces.

Notice, however, MS-DOS-based applications configured to run in MS-DOS Mode use only the real-mode FAT file system. Because of this, long filenames created in a Windows environment are not visible when the system runs in MS-DOS Mode; only the 8.3 filename aliases are visible.

The same is true of files with long filenames that are copied to a floppy disk subsequently used by a down-level FAT file system such as MS-DOS 6.0, Windows 3.1, OS/2 2.11, Windows NT 3.1, and so on.) On down-level file systems, only the 8.3 filename alias is visible on the floppy disk, even if it contains long filenames created in Windows 95.

Technical Notes on Long Filenames

This section summarizes some technical points with regard to long filenames. This information will be helpful to you if you experience problems with long filenames.

Long filenames cannot be used on SUBST drives.

Windows 95 supports SUBST only for backward compatibility with drives created on older systems. Filenames on SUBST drives must comply with the 8.3 filename rule.

Turning off numeric tails for filename aliases.

If you do not want to use filename aliases that automatically use a numeric tail (~n), you can force the file system to create friendly 8.3 filename aliases, at least for the first instance of the 8.3 filename.



To use friendly alias names instead of numeric tails

- Add the value **NameNumericTail = 0** in the following Registry key:

```
Hkey_Local_Machine\System\CurrentControlSet\Control\FileSystem
```

Turning off the extended file system features.

In extremely rare cases, you might determine that you need to turn off the extended file system features in Windows 95. In this case, you can enable the Windows 3.1 file system by changing the Registry. However, this is not a recommended option.

Using the older Windows 3.1 file system affects many of the features available under Windows 95. Also, the Windows 3.1 file system was not tested extensively under Windows 95 in the same way as the new file system. You can expect the following results if you enable the Windows 3.1 file system:

- No support is provided for long filenames
- No extended file information is available, such as creation date and time, and last access date
- Folders cannot be included with user profiles



To enable the Windows 3.1 file system

1. At the command prompt, run **lfnbk /b** to remove long filenames from the hard disk, as described in [Using the LFNBK Utility for Temporary Compatibility](#).

-Or -

At the command prompt, run **scandskw /o** to remove long filenames and all extended file attributes from the disk. To remove long filenames from removable disks, include the drive letter with the command; for example, **scandskw /o a:**

Caution If you use **scandskw /o** to remove long filenames, ScanDisk will check all fixed disks and will repair disk errors without warning you. Changes made with **scandskw /o** cannot be reversed.

2. In Registry Editor, set the value of **Win31FileSystem** to **1** in the following Registry key. Then shut down and restart the computer.

```
Hkey_Local_Machine\System\CurrentControlSet\Control\FileSystem
```

Technical Notes on Disk Device Support

Windows 95 uses layered block device drivers to manage input and output to block devices such as disks and CD-ROM drives. A *block device* is a device such as a disk drive that moves information in groups of bytes (blocks) rather than one byte at a time. Layered block device drivers are 32-bit, flat-model device drivers that run in protected mode. These drivers support conventional and SCSI disk drives, plus partitioned and unpartitioned removable media. Windows 95 also uses layered block device drivers to manage Windows 3.x FastDisk drivers, MS-DOS-based real-mode device drivers, and Windows NT miniport drivers.

Each layered block device driver can be loaded dynamically, so the appropriate driver can be loaded or unloaded as needed without restarting the computer. Although the drivers are virtual device drivers (VxDs), they do not use the standard virtual device services and APIs. Instead, the I/O Supervisor provides the services and functions the device drivers need to complete their tasks.

Specifically, the block I/O subsystem in Windows 95 provides the following:

- Architecture to support all Plug and Play features
- Support for miniport drivers that are compatible with Windows NT
- Compatibility support for Windows 3.1 FastDisk drivers and MS-DOS real-mode disk device drivers
- Protected-mode drivers that take over real-mode MS-DOS device drivers when it is safe to do so

For more information about the block I/O subsystem, see [Windows 95 Architecture](#).

Supported Disk Devices

Windows 95 provides better disk device support than Windows 3.1, but it also ensures compatibility with existing MS-DOS-based and Windows-based disk device drivers. In addition, the disk device drivers in Windows 95 are compatible with Windows NT miniport drivers.

Windows 95 also provides enhanced support for large media using logical block addressing, including hard disks with more than 1024 cylinders. Extensions to the INT 13 disk controller support are provided in the protected-mode disk handler drivers for this support. (Windows 3.1 did not provide this support in its 32-bit disk access drivers.)

The following types of hard disk drives are supported under Windows 95:

ESDI	IDE	MFM
Hardcards	IDE LBA	

The following types of bus adapters are supported under Windows 95:

EISA	PCMCIA	
ISAMCA	RLL	SCSI 2
PCI	SCSI	VL bus

The following sections describe support in Windows 95 for IDE, SCSI, high-speed floppy disk, and removable media devices. Information about SCSI and non-SCSI port drivers is also included.

IDE Drives and Controllers

Windows 95 provides improved support for IDE drive configurations, as summarized in this section.

Support for alternate IDE controllers.

Windows 95 provides protected-mode support for the use of two IDE controllers in a computer, or the combination of an IDE controller in a portable computer and an alternate controller in a docking station (available, for example, in some COMPAQ docking station products). IDE controllers provide support for multiple disk drives.

Support for IDE-based CD-ROM drives.

Currently, most disk devices in personal computers use an IDE-based hard disk controller. Adding a CD-ROM drive typically requires adding an additional controller card to provide either SCSI or a proprietary interface for connecting to the CD-ROM drive. Windows 95 supports new, inexpensive CD-ROM drives that connect to IDE-compatible disk controllers.

Any IDE device that includes mechanisms for identification and declaration of resource requirements can take advantage of Plug and Play.

Note To use Syquest removable IDE drives under Windows 95, the entry **RemovableIDE=true** must be added to the [386enh] section of SYSTEM.INI

Support for large IDE disk drives.

IDE drives are available that support a logical block addressing (LBA) scheme, allowing them to exceed the 0.5 GB (528 MB) size limitation. Windows 95 provides protected-mode support for IDE disk drives larger than 504 MB. The primary partition and the logical drives in an extended partition are each limited to 2 GB, but multiple 2-GB logical drives can be created in an extended partition.

The cluster size for a drive is defined by the Format program, depending on the size of the local drive, as shown in the following table:

Cluster Sizes for Logical Volumes on Hard Disks

Drive size (MB)	Sectors per cluster	Cluster size
0-15 ¹	8	4K
16-127	4	2K
128-255	8	4K
256-511	16	8K
512-1023	32	16K
1024-2048	64	32K

¹ FAT type is 12-bit; all other sizes use 16-bit FAT.

You can also use DriveSpace on 1-GB or 2-GB drives to eliminate the inefficiency of using 32K clusters, but in this case you must create multiple compressed drives. You can also use compression in Microsoft Plus! to create a single compressed drive on disks that are up to 2 GB in size.

SCSI Devices and Drivers

Windows 95 provides support for SCSI disk devices, which was not available in Windows 3.1. SCSI support in Windows 95 includes disk SCSI translator drivers, the SCSI Port Manager, and SCSI miniport drivers.

- A disk SCSI translator driver (also called a SCSI'izer) are responsible for constructing SCSI command descriptor blocks for a specific device class and carrying out device-level error recovery and logging. There are two of these drivers (one for each class): one for SCSI hard disk devices and one for CD-ROM devices.
- SCSI Port Manager manages the interaction between the SCSI'izer and a SCSI miniport driver, initializes the miniport driver, converts the I/O request format, and provides other services for the miniport driver.
- The SCSI miniport driver is responsible for detecting and initializing a specific set of SCSI adapters. The driver also handles interrupts, transmits I/O requests to the device, and carries out adapter-level error recovery and logging. Windows 95 supports the use of Windows NT miniport SCSI drivers without modification or recompiling. Compatibility with Windows NT-based miniport drivers ensures broad device support for disk devices under Windows 95, while simplifying the driver development efforts for hardware manufacturers.

Windows 95 provides broad support for popular SCSI controllers. Windows 95 includes 32-bit disk device drivers for popular SCSI controllers from Adaptec, Future Domain, and other manufacturers. Windows 95 also provides compatibility support for the Advanced SCSI Programming Interface (ASPI) and Common Access Method (CAM), which allows application and driver developers to submit I/O requests to SCSI devices. This allows existing MS-DOS-based applications and drivers that use the ASPI or CAM specification to work properly under Windows 95. Windows 95 also includes 16-bit and 32-bit drivers to support Windows-based ASPI clients and applications.

Although Windows 95 can use Windows NT miniport drivers, the best choice for a SCSI driver is one that complies with Plug and Play. Most Windows NT miniport drivers ignore configuration information from the SCSI Manager and check I/O ports to identify hardware. Miniport drivers in Windows 95 must honor configuration information without scanning for other adapters if the configuration information is not the default configuration. This is because many adapters supported under Windows 95 have port ranges that conflict with other adapters and are affected adversely by scanning. For example, Artisoft® LANtastic® network adapters occupy a range of port addresses used by Adaptec 154X adapters, and accessing these ports will cause the system to lock up.

Windows 95 provides several .MPD files with Plug and Play capabilities, including the ability to transition from protected mode to real mode (to support MS-DOS-based applications that must run in MS-DOS Mode) and to accept configuration information from the SCSI Manager for dynamically loading and unloading drivers.

For information about troubleshooting SCSI devices, see [Devices](#).

Disks and File Systems

Technical Notes on Disk Device Support

Supported Disk Devices

High-Speed Floppy Disk Driver

Windows 95 provides protected-mode support for communicating with floppy disk controllers. Windows 95 provides INT 13 hard disk controller support as 32-bit device drivers, which results in improved performance, stability, and system robustness.

Windows 95 provides floppy disk controller support as a 32-bit device driver, and offers improved performance for file I/O to floppy disk drives, plus improved reliability of the system. You can now format a disk or copy files to and from a disk while performing other tasks.

Removable Media and Docking Devices

Windows 95 provides protected-mode support for removable media devices with MS-DOS-compatible partitions, including floppy disk drives and controllers, Bernoulli drives, and CD-ROM, plus docking stations for portable computers. Windows 95 allows the system to lock or unlock the device to prevent the media from being removed prematurely.

Windows 95 also supports an eject mechanism for devices that support it, so that users can use software control to eject media from a device (for example, new floppy disk drives that support software-based media ejection).

Docking refers to the insertion or removal of a device in the system. Devices that can be docked include almost anything, depending on the hardware — monitors, network access, removable hard disk drives, or any removable resource. A *docking station* is a base unit into which you can insert the portable hardware and which includes drive bays, expansion slots, and additional ports. Port replicators can also be used as docking station substitutes that provide extra functionality not available in the portable docking device.

If a docking change occurs in the computer configuration during operation, such as the insertion of a portable computer into the docking station, the system is notified so that the new device can be configured and applications can be notified of the change.

Windows 95 supports “hot” docking, where the device can be docked or undocked while running at full power, and “cold” docking, where the device must be powered off or restarted before the device can be docked or undocked. Legacy portable computers use cold docking.

In addition, some devices require certain preliminary steps before they can be docked or undocked. For example, if you have a file open and decide to remove the hard disk, the file must be closed. To handle these situations, Windows 95 supports different undocking systems, depending on the type of hardware:

- Auto-ejection, which is a software interface that operates a VCR-type ejection mechanism, allowing Windows 95 to request user action to resolve any open resources. The user can save files and so on before the system ejects the dockable resource.
- Manual ejection, where the user undocks the resource without using any software interface. Because the system cannot be notified when this occurs, any closing of files or other actions must be performed manually to prevent loss of data.

Disks and File Systems

Technical Notes on Disk Device Support

Supported Disk Devices

Non-SCSI Port Drivers

A non-SCSI port driver usually works with a specific adapter, so the driver is retained in memory only if the related adapter is present in the system. Windows 95 includes, for example, port drivers for IDE, ESDI, or NEC floppy disk drives.

A port driver provides the same functionality as the SCSI Manager and miniport driver, but these drivers are monolithic and are not portable to Windows NT. A port driver manages and controls the adapter for a given block device. The port driver detects and initializes the adapter, handles interrupts, transmits I/O requests to the device, and carries out adapter-level error recovery and logging.

Important Do not use a **device=** entry in SYSTEM.INI to load a port driver. Windows 95 loads appropriate drivers from the SYSTEMIOSUBSYS subdirectory in the Windows directory.

VCACHE and CDFS Supplemental Cache

The 32-bit VFAT works in conjunction with a 32-bit, protected-mode cache driver (VCACHE), and replaces and improves on the 16-bit real-mode SMARTDrive disk cache software provided with MS-DOS and Windows 3.1. The VCACHE driver uses an improved caching algorithm over SMARTDrive to cache information read from or written to a disk drive, and results in improved performance for reading information from the cache. Also, the VCACHE driver is responsible for managing the cache pool for CDFS, and the 32-bit network redirectors.

Another big improvement in VCACHE over SMARTDrive is that the memory pool used for the cache is dynamic and is based on the amount of available free system memory. Users no longer need to allocate a block of memory to set aside as a disk cache; the system automatically allocates or deallocates memory used for the cache based on system use. The performance of the system also scales better than earlier versions of Windows, due to the intelligent cache use.

The 32-bit protected-mode CDFS implemented in Windows 95 provides improved CD-ROM access performance over the real-mode MSCDEX driver in Windows 3.1 and is a full 32-bit ISO 9660 CD file system. The CDFS driver replaces the 16-bit real-mode MSCDEX driver, and it features 32-bit protected-mode caching of CD-ROM data. If MSCDEX is specified in the user's AUTOEXEC.BAT when Windows 95 is installed, the 32-bit CDFS driver is used instead.

CDFS has a larger and smarter cache than MSCDEX, optimized just for CD-ROMs and separate from VCACHE. The CDFS driver cache is dynamic and shares the cache memory pool with the 32-bit VFAT driver, requiring no configuration or static allocation on the part of the user.

CDFS reads ahead in parallel with the application so that multimedia presentations play back more smoothly than with earlier versions of Windows. Because CDFS uses a separate cache, the cache memory can be swapped out to the hard disk when CD-ROM activity pauses. This gives applications more room to run and protects the main hard disk cache from being flushed out whenever a very large multimedia stream is played back.

The supplemental cache size for CDFS is used to hold path table, directory, and file information. This particular cache is used to improve CD streaming and to reduce seek latency as effectively as possible with a moderately sized cache. This means that the cache is more complex, using smart priority-based caching schemes to achieve results optimized for CD-ROMs.

For information about configuring the CD-ROM cache to match the characteristics of CD-ROM drive types, see [Performance Tuning](#).

Troubleshooting File and Disk Problems

This section provides information for troubleshooting disk and file system problems, problems with disk utilities, and problems with long filenames.

For information about using the Troubleshooting dialog box for File System Properties in the System option in Control Panel, see [Performance Tuning](#).

There are performance problems with the floppy disk drive.

You can try preventing the floppy disk device driver from attempting to use first-in, first-out (FIFO). To do this, add the value **ForceFIFO=0** to the following Registry key:

```
Hkey_Local_Machine\System\CurrentControlSet\Services\Class\FDC\0000
```

Windows 95 cannot access the drive or reports 2 GB disk space on a larger drive.

In Windows 95, the network client was designed to maintain compatibility with MS-DOS-based applications that assume a 2-GB drive-size limit. If a network drive, such as an NTFS volume on a Windows NT server, has more than 2 GB of free disk space, Windows 95 reports only that 2 GB are available and 0 bytes are used.

Microsoft does not recommend using Windows 95 with a FAT volume larger than 2 GB created in Windows NT. On a dual-boot computer with both Windows 95 and Windows NT installed, you can read from and write to the drive, but you might experience strange results, such as programs reporting 0 bytes free space on the drive. However, you shouldn't experience data loss when accessing a 4-GB drive.

Disk utilities fail on a Windows 95 volume.

Disk utilities that were not designed for the Windows 95 VFAT file system can find unexpected values in fields that were once reserved for MS-DOS. Use disk utilities designed for Windows 95 instead. You might be able to use some earlier utilities by first running LFNBK, as described in [Using the LFNBK Utility for Temporary Compatibility](#).

Problems occur with shortcuts after compressing the Windows 95 volume with Stacker.

Stacker does not recognize or accommodate long filenames. If you compress your Windows 95 volume by using the Stacker DOS compression program, your desktop shortcuts will need to be repaired manually. You will also need to move USER.DAT and USER.DA0 from the host volume to your compressed volume. If you are using Stacker, do not run DriveSpace or DoubleSpace.

A CVF will not mount.

Check the D??SPACE.INI file in the root directory of the boot drive. If this file is damaged, use the DriveSpace program to rebuild it.

The d??space /mount command in AUTOEXEC.BAT does not work.

This occurs because Windows 95 Setup deletes or renames the MS-DOS-based versions of DRVSPACE.EXE and DBLSPACE.EXE. To solve this problem, use **scandisk /mount** as the replacement command live in AUTOEXEC.BAT. The version of ScanDisk provided with Windows 95 has been enhanced for this purpose. For more information, see [Command-Line Commands Summary](#).

Long-Filename Troubleshooting Tips

- Long filenames can cause problems for some disk utilities. Be sure to use disk utilities that are long filename-aware. If you are not sure whether your utility is long filename-aware, consult your disk utility documentation. If long filenames are not mentioned, then your utility probably does not support long filenames.
- Using a down-level file system command (such as **copy** or **rename**) rather than the Windows 95 equivalent will destroy a long filename.
- Because the root directory is limited to 512 entries, you can fill the root directory with fewer files by using long filenames because each long filename takes more than one entry in the directory.
- Although you can disable the creation of long filenames, this should be

used only if error conditions warrant it and if other troubleshooting efforts have failed. For information about turning off the extended file system features, see [Technical Notes on Long Filenames](#).

The 8.3 filename alias was changed.

This can happen when you use options such as Copy, Backup, or Restore. For example, if a file with the name LongFileName is associated with an alias LONGFI~2, and this file is copied to a different directory by using the following:

```
copy LongFileName \TMP\LongFileName
```

Then the alias associated with this file can become LONGFI~1, if such an alias is not already present in the target directory.

The long filename was destroyed.

This can happen when transferring files to or from file systems that do not support long filenames, when running file searches, or when using certain disk utilities. The long filename cannot be restored.

A long filename was lost after the file was edited on another computer.

This occurs because down-level file systems are not aware of the long filename extensions to the FAT file system.

Hard disk device drivers cause the computer to stall.

The I/O Supervisor, which loads hard disk (block) device drivers, requires the driver's files (having filename extensions .PDR, .MPD, .VXD, and .386) to be located in the SYSTEMIOSUBSYS subdirectory of the Windows directory.

If the computer locks up during startup or hardware detection, try the following:

- Check for Windows NT miniport drivers (.SYS files in the IOSUBSYS directory). These drivers detect the I/O ports and might cause the computer to stop. Replace the Windows NT driver with either a Windows 95 miniport or a real-mode driver.
- Check the IOS.INI file for real-mode drivers not replaced by protected-mode drivers.
- When loading protected-mode drivers, the real-mode driver generally remains loaded in memory even though the protected-mode driver "takes over." If you suspect a conflict, type **rem** at the beginning of the line in CONFIG.SYS that calls the real-mode driver.
- Users might have problems with devices (such as tape backups) that use ASPI drivers. Try using only real-mode drivers, then try using only protected-mode drivers.

Virus-detection utilities don't remove a virus.

In general, virus-detection utilities created from earlier versions of Windows can detect but not clean viruses from Windows 95. This is because virus-detection utilities use low-level writes to repair the disk. MS-DOS-based utilities can still be run using the **lock** command.

Introduction

This chapter describes the multimedia architecture and features in Windows 95.

- [Multimedia: The Basics](#)
- [Multimedia: The Issues](#)
- [Multimedia Overview](#)
 - [Media Control Interface](#)
 - [Multimedia Files](#)
 - [Display Control Interface](#)
 - [Support for Multimedia Devices](#)
- [Recording, Editing, and Playing Audio](#)
 - [Windows 95 Support for MIDI](#)
 - [Recording Sound](#)
 - [Controlling Audio Input Levels](#)
- [Playing and Recording Digital Video](#)
- [Buying a Multimedia Computer](#)
- [Troubleshooting Multimedia Software](#)
 - [Correcting Problems with Playing .WAV Files](#)
 - [Correcting Problems in Playing MIDI Files](#)
 - [Correcting Problems with Playing or Hearing an Audio CD](#)
 - [Correcting Problems with Hearing from Headphones](#)

Multimedia: The Basics

For users of multimedia applications and equipment in your organization, installing Windows 95 provides an immediate multimedia upgrade. Its standard architecture for digital video, digital audio, MIDI, and file handling allow for high-quality multimedia effects. This architecture provides the following benefits:

- You can use the Media Control Interface (MCI) to run multimedia devices independently from each other.
- You have enhanced video support using the new Display Control Interface (DCI). For more information, see [Devices](#).
- You can use built-in programs to record, edit, and play digital audio and video.
- You can easily add new multimedia hardware through the Add New Hardware option in Control Panel. The Add New Hardware option is a wizard that guides you through the steps to install and configure drivers for legacy devices. For more information, see [Devices](#).
- You can use the new built-in file sharing to share CD-ROM drives across the network. For more information, see [Logon, Browsing, and Resource Sharing](#).

The performance benefits from the 32-bit Windows 95 architecture ensures that Windows 95 multimedia titles can include digital video and sound with better quality than ever before.

Multimedia

Multimedia: The Issues

In the corporate environment, you need to consider what multimedia features your users will be using to determine what extra hardware they'll need. For example, to use the audio capabilities as described in this chapter, computers need a sound card. For more information, see [Buying a Multimedia Computer](#).

Windows 95 includes basic audio recording, audio playback, and video playback tools, but your users might need more features than these tools offer. For example, if users will be capturing and compressing digital video, they'll need additional software. Consider which additional multimedia software tools you might need to purchase.

If you are planning to play video clips over the network, playback will probably appear somewhat jerky unless your network guarantees a continuous data stream (for example, if you use an isochronous Ethernet network or an asynchronous transfer mode (ATM) network).

Multimedia

Multimedia Overview

This section describes the Windows 95 components that support multimedia hardware and software.

Media Control Interface

The Media Control Interface (MCI) provides applications created for Windows 95 with device-independent capabilities for controlling media devices such as audio hardware, videodisc players, and animation players. This interface works with MCI device drivers to interpret and run MCI commands such as **pause**, **play**, and **stop**.

MCI provides a set of core commands for a broad range of media devices. For example, MCI uses the same command to begin playback of a waveform-audio file, a videodisc track, and an animation sequence. MCI also provides extended commands for using particular device types with unique capabilities, such as using a frame-based time format for animation. For more information about MCI drivers and commands, see the *Microsoft Windows 95 Device Development Kit*.

A *device type* identifies a class of MCI devices that respond to a common set of commands. The following table lists the currently defined MCI device types.

Device type	Description
animation	Animation device
cdaudio	Compact disc (CD) audio player
dat	Digital audiotape player
digitalvideo	Digital video in a window (not GDI based)
other	Undefined MCI device
overlay	Overlay device (analog video in a window)
scanner	Image scanner
sequencer	MIDI sequencer
vcr	Videocassette recorder or player
videodisc	Videodisc player
waveaudio	Audio device that plays digitized waveform-audio files

Multimedia Files

Usually, multimedia files are maintained in one of the formats described in the following table.

Format	Corresponding filename extension
Digital-video	.AVI
Waveform-audio	.WAV
Musical Instrument Digital Interface (MIDI)	.MID

Multimedia files are stored on a compact disc, a local hard disk drive, a network file server, or another storage medium. The playback quality is constrained by the amount of data that the storage medium can continuously supply to the file system.

A multimedia data stream (such as an .AVI file) generally contains multiple components, such as digital-video data, audio data, text, and perhaps other data (such as hot-spot information, additional audio tracks, and so on). As multimedia information is read from the CD-ROM drive, the multimedia subsystem determines what the data stream contains, and then it separates and routes the data accordingly.

Multimedia

Multimedia Overview

Multimedia Files

CD-ROM File System

To get the best possible performance from double-speed and faster CD-ROM drives, Windows 95 includes a new, 32-bit, CD-ROM file system (CDFS) for reading files from CD-ROM drives as quickly and efficiently as possible. For more information about the CDFS, see [Performance Tuning and Windows 95 Architecture](#).

CDFS replaces most Windows version 3.1 MSCDEX drivers.

Multimedia

Multimedia Overview

Display Control Interface

The Display Control Interface (DCI) is a new display driver interface created jointly by Microsoft and Intel Corporation. DCI-compliant drivers provide a fast, direct way for games and digital video in Windows 95 to write to the video frame buffer. It also enables digital-video playback to take advantage of several specific kinds of hardware support included on advanced graphics adapters.

For more information about DCI, see the *DCI Level 2 Specification*. This specification is available through the Microsoft Developer Network (MSDN); to obtain it, call (800) 759-5474, or, from outside the United States and Canada, call (402) 691-0173. For more information about MSDN, see [Windows 95 Resource Directory](#)

Multimedia

Multimedia Overview

Support for Multimedia Devices

Windows 95 includes built-in support for common multimedia authoring devices such as laser discs and video-cassette recorders (VCRs). This makes it easy to set up a computer for *step capture*, a process in which a user captures digital-video data one frame at a time; the data is usually compressed later. This is a slow process, but it results in the highest possible quality of digital video.

To play the contents of a videotape on a computer, users must connect the video and audio outputs from the VCR to the video-capture or overlay and to the audio inputs of the computer. Users might also need to install an MCI digital-video device driver.

Multimedia

Recording, Editing, and Playing Audio

Windows 95 multimedia services provide extensible, device-independent audio support. Windows 95 features services for sound control for computers that have sound cards and for waveform-audio, MIDI, and mixer devices.

With audio support in Windows 95, users can do the following:

- Use the Sound option in Control Panel to assign sound clips to play each time a specific event occurs
- Use CD Player to play audio CDs
- Use Sound Recorder to record sound
- Use built-in Windows 95 OLE support to copy or link audio clips in other documents, as described in [Application Support](#)

For more information about recording, editing, and playing multimedia files, see online Help.

Windows 95 Support for MIDI

Musical Instrument Digital Interface (MIDI) is a serial interface standard that allows for the connection of music synthesizers, musical instruments, and computers. The MIDI standard is based partly on hardware and partly on a description of the way in which music and sounds are encoded and communicated between MIDI devices.

MIDI is used as a development tool for musicians. Virtually all advanced music equipment supports MIDI, and MIDI offers a convenient way to control the equipment very precisely. MIDI is similar to the electronic equivalent of sheet music. For example, if you buy a CD that contains a particular performance of a piece of music, the data on the CD requires no interpretation at all — it's straightforward playback. If you buy the sheet music and have someone play it, it requires very little data, but, depending on the quality of the instruments and the musicians, you can get a good or bad interpretation of that piece of music.

Windows 95 supports the General MIDI Specification to request particular instruments and sounds. This specification is an industry standard that defines how MIDI should be used, and it is supported by Microsoft and most MIDI sound card manufacturers.

Windows 95 supports a new technology called MIDI streams. This technology is used in advanced sound cards to play very complex MIDI sequences with less CPU use. Support for this technology allows Windows 95 to communicate multiple MIDI instructions simultaneously within a single interrupt. As a result, playing MIDI files now requires even less computing power than it did before, and it allows developers to process MIDI instructions, graphics, and other data even more successfully.

For more information about playing a MIDI sound file, see online Help.

Multimedia

Recording, Editing, and Playing Audio

Recording Sound

Users who have microphones connected to their computer can record sound by using Sound Recorder.

When using Sound Recorder, users must use a real-mode compression codec. To turn on voice compression when recording so that the file is compressed in real-time, users must use the GSM 6.10 format in the Sound Selection dialog box in Sound properties.

For more information about recording sound with a microphone, see online Help.

Multimedia

Recording, Editing, and Playing Audio

Controlling Audio Input Levels

Windows 95 includes a Volume Control tool that provides audio line routing services to manage the different audio lines installed on a computer. An audio line consists of one or more channels of waveform-audio data coming from one origin or system resource. For example, a stereo audio line has two data channels, yet it is considered a single audio line. Each audio line also has zero or more mixer controls associated with it. A mixer control can take on a number of different characteristics (such as controlling volume) depending on the characteristics of the associated audio line.

The number of lines users can mix by using Volume Control depends on the number of audio source lines the computer has, and whether they are using Volume Control for input or output.

For more information about mixing sounds, see online Help.

Playing and Recording Digital Video

Windows 95 video services provide the resources for capturing video clips, compressing the content, and controlling playback.

Displaying digital video involves moving and processing huge streams of data continuously and efficiently. In earlier versions of Windows, the process of displaying digital video relied on a series of 16-bit systems — from reading data from the disk, to decompressing the video data, to displaying it on the screen. With the Windows 95 32-bit architecture, users can display bigger, smoother, and more colorful digital video than ever before, without adding any hardware.

Windows 95 multimedia is fully compatible with 16-bit multimedia titles. Early testing has shown that the 32-bit improvements in file access speed and stream handling result in performance gains for 16-bit multimedia applications and especially for the new generation of 32-bit applications developed for Windows 95.



To determine the format in which an existing video clip was authored

- Right-click the icon for the digital-video file, click Properties, and then click the Details tab.

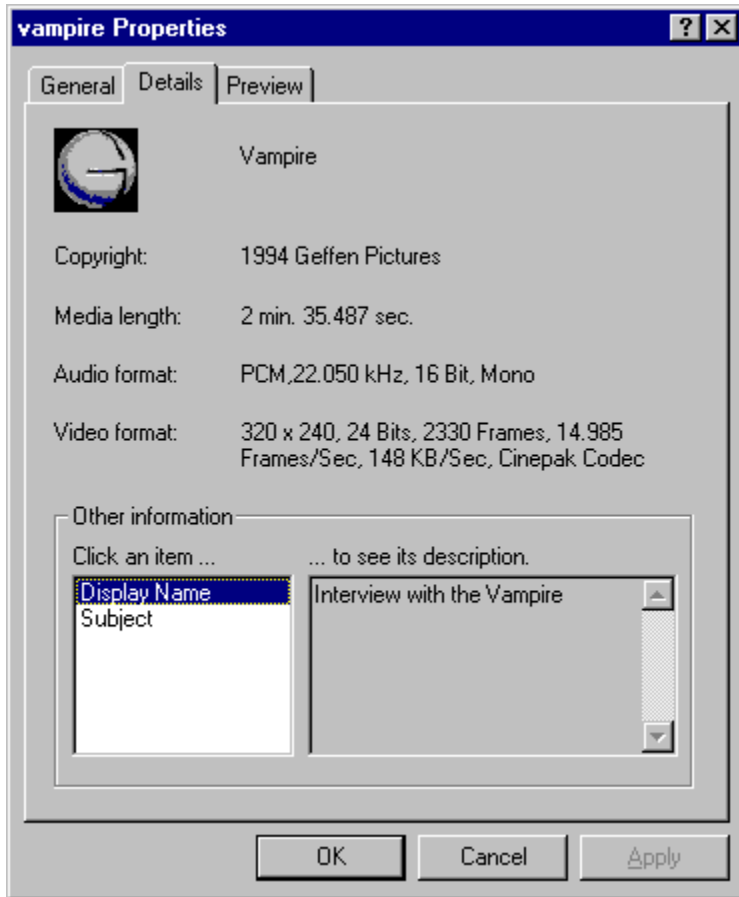

For more information about playing media clips, see online Help.

Buying a Multimedia Computer

The following list provides guidelines for what to look for in a multimedia system, plus specifics for overall sound components, MIDI components, mixing capabilities, and video components.

What to look for in basic computing power.

Make sure to select a balanced computer, in which all components work together to meet the demands of supporting multimedia applications. In multimedia systems, balance is more important than speed, because multimedia playback places heavy demands on the CD-ROM (for reading data), on the hard disk (for writing data), on the CPU (for decompressing), and on the video and audio subsystems (for playback). A fast CPU alone does not guarantee a great playback system. For best results, the computer should have the following components:

- Local-bus video. The performance of a computer with a local bus is about 10 times better than one without a local bus, assuming everything else on the computers is equal. Without local-bus video, a computer will not be able to keep up with the amount of video data that consumer multimedia applications and games currently being produced will attempt to display continuously. Preferably, the system should include a PCI bus.
- A 24-bit display monitor. This is required for TrueColor support.
- A double-speed or faster CD-ROM drive. New multimedia applications assume double-speed data rate.
- Super VGA (800x600) resolution or better with 16-bit color. Because multimedia applications display many different colors and they tend to compete for access to the system palette, it's important to have support for more than 8-bit color.
- 16-bit audio and MIDI. Many multimedia applications make use of sound cards with MIDI support.

What to look for in computer sound support.

The following are some key features to look for when you want to purchase a multimedia computer with great sound support:

- Choose a sound card with a 16-bit digital-to-analog converter (DAC) for playback, and a 16-bit analog-to-digital converter (ADC) for recording (necessary for applications developers).
- Look for a CD-ROM drive with double-speed or faster capabilities and multisession support.
- Look for a system that supports stereo sound and 8, 11, 22, and 44 kilohertz (kHz) waveforms. Compact-disc quality sound uses 44 kHz. The 11 kHz and 22 kHz waveforms are fractions of 44 and are often used for compressed waveforms that are meant to save CPU processing. The 8 kHz waveform is used for Truespeech™ compression.
- Developer systems should also include full-duplex support to record and play sound at the same time.

What to look for in computer MIDI support.

Microsoft recommends that sound cards for both consumer and developer systems include the following:

- General MIDI support. General MIDI refers to a system of assigning numbers to each kind of instrument, so that, for example, instrument 12 on one computer is the same as instrument 12 on all others.
- Polyphony, which means the ability to play multiple sounds at the same time. Consumer systems should include 16-voice polyphony; developer systems should include at least 20-voice polyphony. Support for more concurrent sounds means a fuller-sounding playback.
- MIDI streams. This is an efficient, new capability in Windows 95 whereby a sound card receives and batch-processes multiple MIDI messages (such as Note On and Note Off). With MIDI-stream sound support in the sound subsystem, the CPU is freed from managing those messages individually. This offers virtually flawless playback, even when the CPU is being heavily taxed by large-frame video playback.
- Sampled sound rather than waveform synthesis. Sampled sound is an actual recording of a sound. Waveform synthesis uses a mathematical approximation of that sound.
- Standard MIDI port. Consumers and developers use this port to plug in MIDI devices, such as piano-

style keyboards. It also supports joysticks.

What to look for in mixing capabilities.

A good multimedia system for either a user or a developer should have mixing capabilities. Look for the following features:

- The mixer should mix input from four sources (WAV, MIDI, Redbook, AUX) and present the output as a stereo, line-level audio signal at the back panel of the computer. Each input should have at least a 3-bit volume control (8 steps) with a logarithmic taper.
- Make sure that all sources are within -10 dB and without attenuation. This will ensure that the mixer will not clip, meaning that if a sound peaks, the audio clicks instead of playing that sound. It also ensures that the mixer will output between 0 dB and +3 dB.
- The preferred system should have individual audio source and master digital volume control registers and extra line-level audio sources.

What to look for in computer video support.

The following are some key video-support features to look for when purchasing a multimedia computer:

- Look for a balanced system in which each component has sufficient power. This is important because any of several components on the system could adversely affect the playback quality of a multimedia application. The computer might not have enough space on the CD-ROM or hard disk; the hard disk might not be able to retrieve data fast enough to play back well; the CPU might not have enough power to handle the decompression of the video; or the bus on the video display card might not be fast enough to move all of the data to the screen.
- Look for Super VGA resolution. The minimum resolution for a multimedia computer is VGA, which provides a 640x480-pixel image and 256 colors, also expressed as 8 bits per pixel (bpp). Microsoft recommends that a consumer system include at least a Super VGA display, which provides 800x600-pixel resolution with approximately 64,000 colors (16 bpp) for users working with complicated graphics.

For example, suppose that you are playing a video segment with a shaded maroon background that includes one underwater scene, followed by a skydiving scene, followed by a city street scene. Each scene and its background has very different color qualities. At least one of the scenes or the background will not be displayed well if a full-color clip is translated to a 256-color display.

- Look for a video card with a DCI provider for better performance.
- Look for a computer with a double-speed or faster CD-ROM drive, which reads data from the CD-ROM at a rate of at least 300 kilobytes per second. This is the rate needed to have good-looking 320x240-pixel digital video clips playing at a reasonable frame rate with no undue screen compression. (Screen compression changes resolution, causing a grainy image. At extreme compression, for example, an image of a person might look instead like a bunch of blocks.)

Multimedia

Troubleshooting Multimedia Software

This section describes how to identify and resolve multimedia software problems.

Note Before you attempt any troubleshooting, shut down and restart the computer to verify that the system functions correctly.

For information about troubleshooting related hardware problems, see [Devices](#).

Correcting Problems with Playing .WAV Files

When a multimedia application is unable to play waveform-audio (.WAV) files, it is usually due to one or more of the following problems:

- The sound card is not installed properly.
- You are using Sound Recorder, and a waveform-audio driver is not installed.
- You are using Media Player, and a waveform-audio MCI driver is not enabled.

The sound card is not installed properly.

Most sound cards come with MS-DOS-based programs for playing sounds or testing card configurations. Run these test programs; if the sound card does not work with these programs, then it will not work with Windows 95 sound support.

Make sure the sound card settings do not conflict with other hardware. Use the Add New Hardware icon in Control Panel to detect your hardware, which will determine if you have any hardware for which the appropriate driver is not yet installed. Verify port and IRQ settings.

Note If the sound card can play MIDI files, the card is properly installed.

A waveform-audio driver is not installed.

If you are running Sound Recorder and there is no waveform-audio driver installed, you will receive an error message. In this case, make sure that the waveform-audio driver is listed in the Multimedia Devices list; you can see this list by clicking the Advanced tab in the Multimedia option in Control Panel. If the sound card is compatible with Sound Blaster™, try using the Sound Blaster driver provided with Windows 95. If you cannot find the correct driver for the sound card in the list, try using the Windows 3.1 driver for that card.

A waveform-audio MCI driver is not enabled.

If you are running Media Player and cannot play .WAV files, perform the following procedure to correct the problem.



To enable the waveform-audio MCI driver

1. In the Multimedia option in Control Panel, click the Advanced tab.
2. In the Multimedia Devices list, click the plus (+) sign next to Media Control Devices.
If Wave Audio Device (Media Control) does not appear in the list, the driver is not installed.
3. Click Wave Audio Device (Media Control), and then click the Properties button.
4. In the properties dialog box, click Use This Media Control Device.

Correcting Problems in Playing MIDI Files

When a multimedia application is unable to play MIDI files, it is commonly due to one or more of the following problems:

- The sound card is not installed properly.
- You are using Sound Recorder and a MIDI driver is not installed.
- A MIDI MCI driver is not installed.
- The .IDF file is invalid or corrupt.

The sound card is not installed properly.

Most sound cards come with MS-DOS-based programs for playing sounds or testing card configurations. Run these test programs; if the sound card does not work with these programs, then it will not work with Windows 95 sound support.

Make sure that the sound card settings do not conflict with other hardware. Use the Add New Hardware option in Control Panel to detect your hardware, which will determine whether you have any hardware for which the appropriate driver is not yet installed. Verify port and IRQ settings.

Note If the sound card can play .WAV files, the card is properly installed.

A MIDI driver is not installed.

If you are using Sound Recorder and cannot play a MIDI file, it might be because there is no MIDI driver installed. If the sound card is compatible with AdLib, try using the AdLib driver provided with Windows 95. If you don't find the correct driver for the sound card in the list, try using the Windows 3.1 driver for that card (however, the Windows 3.1 driver might not be compatible with Windows 95).

A MIDI MCI driver is not installed or enabled.

In Media Player, make sure that the option named MIDI Sequencer appears in the Device menu. If not, then the MIDI MCI driver is not installed or not enabled.



To verify that the MIDI MCI driver is enabled

1. In the Multimedia option in Control Panel, click the Advanced tab.
2. In the Multimedia Devices list, click the plus (+) sign next to Media Control Devices.
If MIDI Sequencer Device does not appear in the list, the driver is not installed. See the following procedure for instructions.
3. Click MIDI Sequencer Device (Media Control), and then click the Properties button.
4. In the properties dialog box, click Use This Media Control Device.



To install the MIDI MCI driver

1. In the Add New Hardware option in Control Panel, click No when prompted to have Windows 95 search for your hardware, and then click the Next button.
2. In the Hardware Types list, click Sound, Video And Game Controllers, and then click the Next button.
3. Click Microsoft MCI in the Manufacturers list, and then click MIDI Sequencer Device (Media Control) in the Models list. Click the Next button.
4. To complete the installation, click the Finish button.

The .IDF file is corrupt or invalid.

Copy the appropriate .IDF file for each device installed. For general MIDI devices, obtain a new copy of GENERAL.IDF from the Windows 95 disks. For MIDI devices that come with their own .IDF file, reinstall the file from the device's setup disks.

Correcting Problems with Playing or Hearing an Audio CD

When a user is unable to hear an audio CD being played, it is commonly due to one or more of the following problems:

- The CD-ROM drive is not installed properly.
- An MCI CD audio driver is not installed.
- The CD-ROM drive and the sound card are not connected.

The CD-ROM drive is not properly installed.

Place a data CD in the CD-ROM drive and make sure you can view the files in Windows Explorer or list the files at the command prompt. If you can, then the CD-ROM drive is properly installed. If not, verify your disk drivers (ESDI, SCSI, Proprietary, MSCDEX) and make the appropriate configuration changes so that you can view the files on a data CD.

The CD audio MCI driver is not installed.

In Media Player, make sure that the option named CD Audio appears in the Device menu. If not, then the CD audio MCI driver is not installed or not enabled.



To verify the CD audio MCI driver is enabled

1. In the Multimedia option in Control Panel, click the Advanced tab.
2. In the Multimedia Devices list, click the plus (+) sign next to Media Control Devices.
If CD Audio Device (Media Control) does not appear in the list, the driver is not installed. See the following procedure for instructions.
3. Click CD Audio Device (Media Control), and then click the Properties button.
4. In the properties dialog box, click Use This Media Control Device.



To install the CD audio MCI driver

1. In the Add New Hardware option in Control Panel, click No when prompted to have Windows 95 search for your hardware, and then click the Next button.
2. In the Hardware Types list, click Sound, Video And Game Controllers, and then click the Next button.
3. Click Microsoft MCI in the Manufacturers list, and then click CD Audio Device (Media Control) in the Models list. Click the Next button.
4. To complete the installation, click the Finish button.

The CD-ROM is not connected to the sound card.

If the CD-ROM is playing and there is no sound coming from the sound card speakers, try plugging the speakers or headphones into the audio jack on the face of the CD-ROM drive. If you get sound, then check the internal or external audio connection between the CD-ROM drive and the sound card.

Multimedia

Troubleshooting Multimedia Software

Correcting Problems with Hearing from Headphones

Verify that the sound card is correctly installed by reviewing the card's properties.



To view your sound card's properties

1. In the Multimedia option in Control Panel, click the CD Music tab.
2. Make sure that the volume level is set to produce sound from the headphones. If not, use the slider to adjust the volume.

Introduction

With Windows 95, you can run Win32-based, Win16-based, and MS-DOS-based applications. This chapter offers some tips you can use to ensure that applications run well under Windows 95.

- Application Support: The Basics
- Application Support: The Issues
- Installing Applications
 - Installing and Sharing Applications Across the Network
 - Creating an APPS.INI File
- Removing Applications
- Running Applications
 - Associating a File Type with an Application
 - Configuring the Start and Programs menus
 - Using the Windows 3.x Program Manager with Windows 95
 - Closing Failed Programs
- Configuring MS-DOS-Based Applications
 - Changing MS-DOS-Based Application Properties (PIF Files)
 - Changing Memory Settings for MS-DOS-Based Applications
 - Setting Properties for MS-DOS-Based Applications
 - Setting Paths for MS-DOS-Based Applications
 - Understanding the APPS.INF File
- Using OLE to Share Data Between Applications
- Technical Notes on Application Support
 - System Changes Affecting Application Support
 - How Windows 95 Accommodates Application Problems
- Troubleshooting Applications

Application Support: The Basics

Windows 95 optimizes the performance of new Win32-based applications and existing applications created for MS-DOS and earlier versions of Windows. They perform more smoothly because Windows 95 significantly increases system resources available to them and more efficiently manages how they use system memory. Windows 95 also supports new and existing versions of OLE technology, including OLE Controls and OLE Automation for new Windows-based applications.

Increased system resources.

Windows 95 increases system resources for all applications by using 32-bit heaps to store applications' data structures, making more resources available for the remaining data elements. In addition, Windows 95 increases the number of timers, COM and LPT ports, Windows menu handles, and other resources available to applications. For more information, see [Performance Tuning](#).

Improved memory management.

The Virtual Machine Manager, an integral part of Windows 95 architecture, manages the memory that each application needs. A virtual machine (VM) is an environment in memory that seems to function as a separate computer for each application. All Win32-based and Win16-based applications run in the System VM, in which all system processes also run. Each MS-DOS-based application runs in its own VM. For more information, see [Windows 95 Architecture](#).

Win32-Based Applications

Win32-based applications receive the full benefit of the performance enhancement features in Windows 95. Because each Win32-based application runs in a separate memory space, it can take complete advantage of the preemptive multitasking capabilities of Windows 95.

Requirements for Windows 95 Logo.

To get the best possible performance, upgrade to versions of applications that were designed for Windows 95 whenever possible. Applications written specifically for Windows 95 carry the "Designed for Windows 95" logo. To qualify for a Windows 95 logo, applications must meet the following requirements:

- Use Win32 APIs executable in the PE (Portable Executable) format
- Support Windows 95 user interface (shell), including the following:
 - Use system metrics for sizing
 - Use system colors (recommended)
 - Use the right mouse button for context menus and not for anything else (recommended)
 - Use Windows 95 Setup guidelines to make the application visible in the shell
- Use long filenames
- Be aware of Plug and Play events (recommended)
- Run successfully on Windows NT 3.5 or later

There are modified requirements for file-based applications, utilities such as virus-checking software, and compilers and other development tools. For more information, contact the Microsoft Developer Network (MSDN). In Canada or the United States, call (800) 759-5474, or in Europe call 31 10 258 88 64.

Win16-Based and MS-DOS-Based Applications

Win16-based applications designed for Windows 3.1 run under Windows 95 without modification, but these applications run in a shared memory space and cannot take advantage of preemptive multitasking. However, they do benefit from improvements incorporated into the Windows 95 subsystem. For Win16-based and MS-DOS-based applications that are known to need special parameters to run, Windows 95 includes an APPS.INF file that defines parameters for each application.

Because of default settings and other support in Windows 95, you do not need to have CONFIG.SYS, AUTOEXEC.BAT, and INI files to run Win16-based and MS-DOS-based applications, although you can still use settings from existing files. When you upgrade by replacing Windows 3.1 with Windows 95, Windows automatically moves the current settings for your installed applications to the Registry for use with Windows 95.

MS-DOS-based applications can take advantage of the improved memory management and increased system resources that are made possible by the new system architecture. Most applications can now run in a window. MS-DOS-based applications that do not run well under Windows can run the application in exclusive MS-DOS Mode, which makes all system resources available to that application, [Changing Memory Settings for MS-DOS-Based Applications](#).

When running under Windows 95, MS-DOS-based applications also benefit from the following:

- Improved robustness, including better virtualization for computer resources, such as support for timers and sound devices.
- Improved support for highly graphical MS-DOS-based applications. This allows you to run video-mode style applications in a window rather than in a full screen.
- Improved memory protection. Windows 95 includes a global memory-protection attribute in the properties dialog box for executable files. This attribute allows the MS-DOS system area to be protected from errant MS-DOS-based applications.
- Improved printing performance and font support, including user-scalable windows with support for TrueType® fonts in virtual machines (VMs).
- Local environmental settings for VMs. You can also customize the VM environment by specifying a batch file in an executable file's properties.

Application Support: The Issues

Before you install and configure applications for use with Windows 95, consider the following questions:

- How will applications perform in your networking environment? After you set up Windows 95 on the network, you will need to install and test how applications perform. For example, for MS-DOS-based applications that were created for your network, test whether they can run in a window or if you need to run them in MS-DOS Mode. After you test them, disperse information to users about how to run different applications.
- Do the default settings for MS-DOS-based applications work well for each of your applications? You can use the executable file's properties dialog box to modify settings as needed, as described in [Configuring MS-DOS-Based Applications](#).
- Do you need to restrict users from running MS-DOS-based applications? Or do you want to allow only certain Windows-based applications to run on a computer? For computers that run File and Printer Sharing services, where access to the shared resources is critical to other users, you may want to restrict the ability to switch to MS-DOS Mode to ensure that shared resources are always available. For information about using system policies to restrict access to MS-DOS Mode or restrict the applications that can run on a computer, see [User Profiles and System Policies](#).
- Which applications do you want to share over the network? With Windows 95, most applications can be shared across the network by installing them on a network computer and then creating a shortcut to them. Users can open them from the network location by double-clicking the shortcut. For more information, see [Installing and Sharing Applications Across the Network](#).
To share some large applications, you must run a separate setup on the server and on the workstation. Check the documentation for the application before attempting to share it across the network.
- Which TSRs do you need to run to support applications? If you are running Client for NetWare Networks, you cannot process TSRs in a logon script. For information about how to load a TSR, see "Running Logon Scripts with Client for NetWare Networks" in [Logon, Browsing, and Resource Sharing](#).
- Do you want users to have access to the Windows 3.1 Program Manager rather than to the new Windows 95 interface? For information, see [Using the Windows 3.x Program Manager with Windows 95](#).

Installing Applications

How you install and configure an application depends on whether it is created for Windows 95, an earlier version of Windows, or MS-DOS.

Using Add/Remove Programs with Win32-based applications.

Windows 95 simplifies installing applications created for Windows 95 by providing an Add/Remove Programs option in Control Panel. When you install an application by using this option, Windows 95 does the following:

- Adds information about the application to the Registry, such as which parameters to use to run the application and which files to delete when removing the application from the computer.
- Searches drives A and B for applications named INSTALL or SETUP. If a setup application uses a name other than INSTALL or SETUP, start the setup application by double-clicking its icon in My Computer.

Keeping Windows 3.1 settings.

If you upgrade by placing Windows 95 in the Windows 3.x directory, you do not need to reinstall applications. Setup automatically moves information about currently installed applications to the Registry. Setup also converts existing Program Manager groups and adds them to the Programs menu on the Start menu.

If you install Windows 95 in a separate directory, you must reinstall all Windows-based applications to ensure that they work properly under Windows 95. Copying .GRP and INI files from your previous Windows directory is not sufficient to run applications under Windows 95.

Creating applications groups and icons.

When a Windows-based setup application creates an application group and icons, Windows 95 creates folders and icons for the Programs menu on the Start menu. If a setup application fails to create a shortcut correctly, you can do it manually. For information about adding shortcuts to the Start menu, see online Help.

Running specific applications.

For information about whether a specific application runs under Windows 95, check the Windows 95 README.TXT file. If you do not find an application listed in the README.TXT file, check with the application's manufacturer or your software vendor. Windows 95 provides a utility that makes an incompatible application compatible with Windows 95. The "make compatible" utility is a file named MKCOMPAT.EXE in the Windows SYSTEM directory. For more information, see [Troubleshooting Applications](#).

Installing MS-DOS-based applications.

You can install an MS-DOS-based application by running its executable file. Windows 95 copies information about the application from the APPS.INF file to the application's PIF file. If it was installed under an earlier version of Windows 95, Setup automatically moves its settings to the new APPS.INF file. If there is no information about the application in APPS.INF, Windows 95 uses default settings instead, or you can manually set the properties, as described in [Setting Properties for MS-DOS-Based Applications](#).

Note Windows 95 has no separate PIF Editor. To configure an application, right-click the application's executable file, and then click Properties.

For more information about installing applications after you have installed Windows 95, see online Help.

Installing and Sharing Applications Across the Network

You can share most applications on a network by installing them on a network computer and then creating a shortcut to them. Users can run the application by double-clicking the shortcut or by double-clicking the application's icon in Network Neighborhood.



To share an application on the network

1. Install an application on a network server or workstation, as described in the documentation from the vendor.
2. In Network Neighborhood, right-click the icon for the application, and then click Create Shortcut. Windows 95 asks if you want to create a shortcut on the desktop.

For more information about creating shortcuts, see online Help. For information about creating and distributing custom shortcuts using system policies, see [User Profiles and System Policies](#).

Tip In general, Windows 95 doesn't allow you to specify a working directory in the properties sheet of a Win16-based application. This is because the program file has links assigned to it that rely on unchanging data. However, you can achieve the same effect by creating a shortcut for the application and specifying a working directory in the Start In box in the properties for the shortcut.

Creating an APPS.INI File

If users will be installing applications from source files stored on the network, you can create an APPS.INI file that contains a master list of applications and their network locations. When a user's Registry contains a reference to the APPS.INI file, a new tab named Network Install appears in Add/Remove Programs. The Network Install tab lists all the applications that appear in the APPS.INI file.



To create an APPS.INI file

1. Use a text editor to create a file that contains list of applications using the following format:

application name = [*] *UNC path*

For *application name*, substitute the name that you want users to see on the Network Install tab. For *UNC path*, substitute the network location of the setup application. If a setup application cannot work with UNC names, include an asterisk before it. For example:

```
word for windows=*\\applications\forusers\word60\setup.exe
```

2. Save the APPS.INI file on a server to which users have read-only access.



To display the applications listed in APPS.INI on the Network Install tab

1. In the Registry, click the following key:

```
Hkey_Local_Machine/Software/Microsoft/Current Version
```

2. Right-click a blank area in the right pane, and then click New.
3. Click String Value. Then type **appinstallpath** and press ENTER.
4. Right-click the item you just created. Then click Modify.
5. In the Value Data area, type the UNC path to the APPS.INI file.

For information about adding Registry settings in setup scripts, see [MSBATCH.INF Parameters](#).

Removing Applications

If you installed applications designed for Windows 95 by using the Add/Remove Programs option in Control Panel, they can safely be removed in the same way. Because the application's components are tracked through the Registry, Windows 95 deletes all of the application's files unless those files are being used by another installed application. Shared files are retained on the hard disk.

For more information about removing an application that was designed for Windows 95, see online Help. For all other applications, check their documentation to determine which files should be removed.

Note To appear in the uninstall list in the Add/Remove Programs option, an application must provide an uninstall utility. Only applications designed for Windows 95 include this functionality.

Removing a Win16-based or MS-DOS-based application is not always straightforward. You can delete the directory that contains the application but, especially in the case of Win16-based applications, additional files belonging to the application are often located in the Windows or Windows SYSTEM directory. There is no way to determine which applications placed certain files in these directories, so some of the application's files may be left behind on your hard disk.

Conversely, if you try to delete all the files of an application installed in the Windows or Windows SYSTEM directory, you might delete a system file that is used by other applications. If this happens, the other applications will not run properly and must be reinstalled.

To avoid problems when removing Win16-based or MS-DOS-based applications, check their documentation for instructions about removing them, and keep backup copies of DLLs and other essential system files in case you need to restore them.

Running Applications

There are several ways to start applications in Windows 95:

- Click the Start button, point to Applications, point to the folder that contains the application, and then click the application's name.
- In My Computer or Windows Explorer, double-click the application's icon.
- Click the Start button, click Run, and then type the path and filename for the application's executable file.
- Right-click the desktop, point to New, and then click Shortcut. Use the Create Shortcut wizard to create a shortcut to applications. To start the application, double-click the shortcut icon on the desktop.
- In My Computer or Windows Explorer, click the icon, click the File menu, and then click Open. Or right-click the application's icon, and then click Open.
- Click the Start button, and then click Run. Drag an executable file from My Computer, Windows Explorer, or Network Neighborhood into the Run dialog box. If there is already text in the Run dialog box, the executable file you drag into the dialog box (including the application's path or UNC name) is appended to the existing text.
- Use the Windows 3.1 Program Manager. For more information, see [Using the Windows 3.x Program Manager with Windows 95](#).



To bring a running application to the foreground

- On the taskbar, click the button for the application.
– Or –

Press ALT+TAB until the icon for the application you want is selected.

Tip Instead of starting a popular Windows-based application to view a document, you can use Quick View. For example, if you are searching for a particular document, but aren't sure of its name, you can use Quick View to look at individual documents. When you find the document you're looking for, you can click the File menu in Quick View, and then click Open File For Editing. For more information, see online Help.

Associating a File Type with an Application

To open an application when you double-click a related document file, the file's type must be defined in the Registry. If the file type is defined in the Registry, it appears in a list of file types that you can associate with an application.

For information about associating a file type with an application so that the application runs when you double-click a file, see online Help.

If a file type has been associated with an application, you can reassociate the file type to a different application.



To reassociate a file type

1. Double-click My Computer, and then click the View menu.
2. Click Options, and then click the File Types tab.
3. Click the type of document you want to reassociate, and then click Edit.
4. In the Actions list, click Open, and then click Edit.
5. In the Application Used To Perform Action area, type the path to the application you want to associate with the file type.

Some applications, such as Microsoft Word, associate multiple extensions with a file type. For example, a Microsoft Word document is associated by default with both a .DOC and an .RTF extension. This can cause problems if a user wants to change which application opens a particular file. To reassociate a file type with an application under these conditions, you must delete all extensions registered to that application, and then re-associate each file type with an application. In addition, you must redefine Open, Print, and DDE commands for each file type. To do this, in My Computer or Windows Explorer, click the View menu, click Options, and then click the File Type tab.

If you click New in the File menu in Windows Explorer or in the context menu, a list of objects appears, such as Folder or Microsoft Excel 5.0 Worksheet. Clicking an object creates a new object in Windows Explorer or on the desktop. You can add an object to this list by adding a key called ShellNew to the corresponding file extension in the Registry for the related filename extension:

```
Hkey_Classes_Root\.ext
```

After creating the ShellNew key, you need to add a new string value called **FileName** with a data value that equals the path name to a template file in the ShellNew subdirectory. For example:

```
filename="c:\windows\shellnew\excel.xls"
```

Tip In the Open dialog box in a Windows-based application, you can request that multiple file types be displayed by separating the file types with a semicolon. For example, to see .DOC, .TXT, and .RTF files in an Open dialog box you would type ***.doc; *.txt; *.rtf**.

Configuring the Start and Programs menus

The items that appear on the Start and Programs menus are arranged alphabetically. To specify a different order, rename menu items to include a number as their first character. Renaming menu items in this way also enables users to start an application by pressing the number at the beginning of the application's name.



To specify the order in which items on the Start or Programs menu appear

1. Right-click the Start button, and then click Open.
2. To specify the order of items at the top of the Start menu, skip to step 3.
To specify the order of items on the Programs menu, double-click the Applications folder.
To specify the order of items on a submenu of the Programs menu, double-click the Applications folder, and then double-click the folder that corresponds to the submenu.
3. Right-click the item that you want to appear first on the menu, and then click Rename.
4. Press HOME, type the number 1 followed by a space, and then press ENTER.
5. Repeat steps 3 and 4 using consecutive numbers until all the menu items that you want to arrange in a different order have been numbered.

For information about the following topics, see online Help:

- Adding an application to the Start or Programs menu
- Adding new submenus (or folders) to the Programs menu
- Rearranging items on the Programs menu

Note Windows 95 adds your most recently used documents to the Documents menu or the Start menu. When you open a file in a Win32-based application, Windows 95 adds the data file to the Documents menu. Windows 95 does not add files to this list that were opened in a Win16-based application. However, if you double-click a document in Windows Explorer or My Computer, Windows 95 does add it to the list.

Using the Windows 3.x Program Manager with Windows 95

Some users may not feel comfortable moving to the new Windows 95 interface immediately after you upgrade their computers from Windows 3.x. To ease their transition, you can use the a Windows 3.x Program Manager.

When you replace Windows 3.x with Windows 95, you can choose to include Program Manager on the Windows 95 desktop. Program Manager does not support the following Windows 95 functionality:

- You cannot copy an item from a Program Manager group to the Windows 95 desktop, and you cannot copy My Computer, Network Neighborhood, Control Panel, or the Printers folder to a Program Manager group.

The folders that were created when you installed Windows 95 are not designed to work with Program Manager. Program Manager recognizes files only.

- When you copy a shortcut to a Program Manager group, the shortcut's name is truncated to eight characters.

In this case, Program Manager uses the filename (minus the extension) for the shortcut's name. For example, if you copy the MS-DOS Prompt shortcut from My Computer to a Program Manager group, the MS-DOS Prompt description is shortened to MS-DOSPR. This occurs because the MS-DOS Prompt shortcut uses the filename MS-DOSPR.LNK. To rename the shortcut, click it, click the File menu in Program Manager, and then click Properties. In the Description field, type a new name.

- When you copy a shortcut or other item to Program Manager, the item's icon is lost.

This occurs because the icon created in the Program Manager group references a file with an .LNK extension. Because Program Manager does not recognize this extension, a generic icon appears. To change the icon, click it, click the File menu in Program Manager, and then click Properties. Click Change Icon, and then select a different icon.

- You cannot quit Windows 95 by quitting Program Manager. To quit Windows 95 or restart your computer, click the Start button, and then click Shut Down.

Tip For a comparison of Windows 95 and Windows 3.x features, see "If You've Used Windows Before" in online Help.

If you want to run Windows 3.1 Program Manager, it must be installed during Windows 95 Setup.



To install the Windows 3.1 Program Manager during Windows 95 Setup

1. In Windows 95 Setup, choose Custom as the Setup Option type.
2. In the Computer Settings dialog box, click User Interface, and then click Change.
3. Click Windows 3.1 (Program Manager), and then click OK.

After Setup, a shortcut for Program Manager appears in the StartUp folder. This causes Program Manager to start every time Windows 95 is started.

After users grow familiar with the Windows 95 interface, they will probably prefer to use it to run applications and manage files. At this point, you can remove the shortcut to Program Manager from the StartUp folder.

Closing Failed Programs

If an application stops responding, or other parts of the computer, such as the keyboard, mouse, or display no longer function correctly, you can end the malfunctioning process or application without quitting other applications or Windows 95. This ability to recover from problems related to a specific application ensures robust performance in Windows 95.



To end a failed process or quit an application that has stopped responding

1. Press CTRL+ALT+DEL.

The Close Application dialog box appears. If Windows 95 detects that a processor application has failed, the words “not responding” appear beside it.

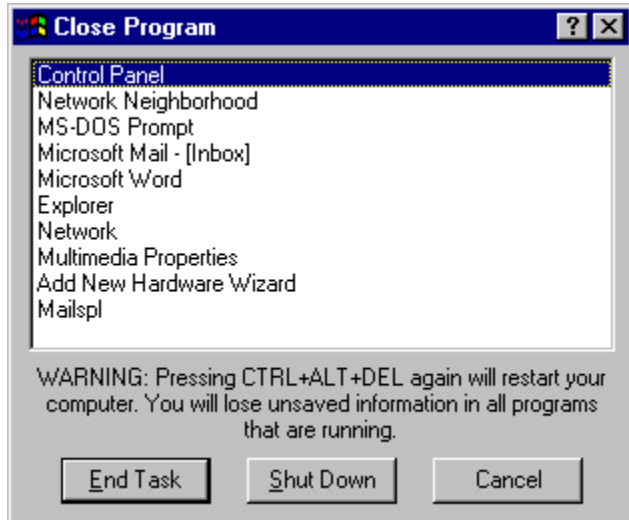

2. Click the process or application you want to close, and click End Task.

Some applications may have several processes running simultaneously. For example, a mail application may be running an executable application and a spooler. If a single process fails and you close that process, the rest of the application may continue to run.

Although it is possible to restart your computer by pressing CTRL+ALT+DEL twice, it is not recommended. Correctly restarting or shutting down your computer ensures that all current information is saved in the Registry and that each application is closed correctly before Windows closes. It also ensures that users who are connected to a shared resource do not lose data when a computer running File and Printer Sharing is shut down.

For more information about restarting or shutting down a computer, see online Help.

Application Support

Configuring MS-DOS-Based Applications

Windows 95 configures conventional memory in the same way as earlier versions of MS-DOS, allowing MS-DOS-based applications to run smoothly in Windows 95. For more information about how Windows 95 makes system memory available to MS-DOS-based applications, see [Performance Tuning](#).

Changing MS-DOS-Based Application Properties (PIF Files)

You can set unique properties for individual MS-DOS-based applications. You may want to do this to customize the way an application runs or if the default properties that Windows 95 uses do not work correctly.

An application's settings are recorded in its application information file (PIF). Windows 95 has no separate PIF Editor. To configure an application, right-click the application's executable file, and then click Properties. Any settings you change in the Properties dialog box are recorded in the PIF file.

When you replace Windows 3.1 with Windows 95, PIFs are upgraded to the Windows 95 format. All existing settings should be preserved, but you may want to verify that they have been.

Windows 95 first searches for a PIF in the directory that contains the executable file you are starting. If Windows 95 cannot find a PIF there, it searches the Windows PIF directory. If there is no PIF in the Windows PIF directory, Windows 95 searches the path specified in the AUTOEXEC.BAT file. If no PIF is found, Windows 95 searches the APPS.INF file for a match.

If Windows 95 does not find an entry for an application in the APPS.INF file, it uses default settings for the application. If you replace Windows 3.1 with Windows 95, a _DEFAULT.PIF file remains in the directory. In this case, Windows 95 uses information in the _DEFAULT.PIF file to create a PIF for the application.

If you do not have a _DEFAULT.PIF file and want to create one, you can do so by copying the DOSPRMPT.PIF to _DEFAULT.PIF.

Regardless of how the settings for an application are initially established, you can change them by right-clicking the application's executable file, and then clicking Properties. For more information, see the section [Understanding the APPS.INF File](#).

Note You can run a batch file using that batch file's settings by typing its name directly at the command prompt or in the Run dialog box. To run a batch file using the settings of the command prompt (COMMAND.COM), precede the name of the batch file with **command /c**; for example, **command /c myfile.bat**.

Changing Memory Settings for MS-DOS-Based Applications

Windows 95 provides a flexible environment for running MS-DOS-based applications, even those applications that must have exclusive access to system resources. Almost all MS-DOS-based applications should run under Windows 95. For MS-DOS-based applications that need sole access to computer resources, Windows 95 offers MS-DOS Mode.

When an MS-DOS-based application starts in MS-DOS Mode, Windows 95 removes itself from memory (except for a small stub) and provides the application with full access to all the computer's resources. Before running an application in this mode, Windows 95 ends all running tasks, loads a real-mode copy of MS-DOS, and uses customized versions of the CONFIG.SYS and AUTOEXEC.BAT files to run the application. After you quit the MS-DOS-based application, Windows 95 restarts and returns to the Windows 95 user interface.

Caution Running an MS-DOS-based application in MS-DOS Mode does not necessarily improve its performance, but it does allow you to run it when it might not otherwise run in Windows 95.



To configure an MS-DOS-based application to run in MS-DOS Mode

1. In My Computer, right-click the application's executable file, and then click Properties.
2. In the application's properties, click the Program tab, and then click Advanced.
3. In the Advanced dialog box, click MS-DOS Mode.

If an MS-DOS-based application, such as a game, performs badly because of insufficient memory or a lack of appropriate drivers, you can try the following:

- Run the application in MS-DOS Mode.
- Adjust the amount of memory available.
- Create a custom startup configuration by modifying the contents of the CONFIG.SYS and AUTOEXEC.BAT files, either at the command prompt or in the application's properties.



To adjust the amount of memory available to an MS-DOS-based application

1. In My Computer, right-click the application's executable file, and then click Properties.
2. In the Application's properties, click the Memory tab, and then increase or decrease the amount of memory available to the application. For more information about the types of memory, see [Setting Properties for MS-DOS-Based Applications](#).



To create a custom startup configuration

1. In My Computer, right-click the application's executable file, and then click Properties.
2. In the application's properties, click the Application tab, and then click Advanced.
3. In the Advanced dialog box, click MS-DOS Mode, click the option named Specify A New MS-DOS Configuration, and then create a custom startup configuration.

Note Windows 95 automatically provides expanded memory for MS-DOS-based applications that require it to run. Windows cannot provide this memory, however, if you include a statement in CONFIG.SYS that loads EMM386.EXE with the **noems** parameter. When you include EMM386.EXE in CONFIG.SYS, use the **ram** parameter or use the **x=mmmm-nnnn** statement to allocate enough space in the upper memory area for Windows 95 to create an EMS page frame. For more information, see [Command-Line Commands Summary](#).

Tip for Running MS-DOS-Based Games

In most cases, MS-DOS-based games run under Windows 95 with no special adjustments. Most popular games are listed in the Windows 95 APPS.INF file. Games that include a Windows 3.1 PIF file should also continue to perform well. Certain PIF settings are now obsolete, however, because Windows 95 manages them automatically. These settings include

foreground and background priorities, exclusive priority, video memory usage, and video port monitoring.

If you run a game that uses graphics modes and Windows 95 fails to run it in a full screen, press ALT+ENTER. To run the game in a full screen every time you start it, right-click the game's executable file, and then click Properties. Click the Screen tab, and then click Full Screen. You can also use the Properties dialog box to adjust other settings that improve performance. For more information, see [Setting Properties for MS-DOS-Based Applications](#).

Application Support

Configuring MS-DOS-Based Applications

Setting Properties for MS-DOS-Based Applications

In Windows 95, the properties sheets replace PIF Editor, which was used in earlier versions of Windows to optimize settings for MS-DOS-based applications.



To view or modify the properties settings for an MS-DOS-based program

1. Right-click the icon for the program, and then click Properties. (If the program's icon is not on the Windows 95 desktop, use Windows Explorer to find the program, then right-click the icon in Windows Explorer.) This displays the properties sheets for the program.
2. Click the tab you want to use and change the options as appropriate. (See the following section for information about all of these options.)
3. Do the same for all other options and tabs, and then click OK.

MS-DOS-based programs have six properties sheets — General, Program, Font, Memory, Screen, and Misc.

Use the General properties to see information about the type, size, and location of the MS-DOS-based application. From this properties sheet, you can turn on and off the Read Only, Archive, Hidden, and System attributes, which have the same meaning as they do in MS-DOS.

Caution Do not change file attributes unless you are absolutely sure of what you are doing.

General properties
for an MS-DOS-based application

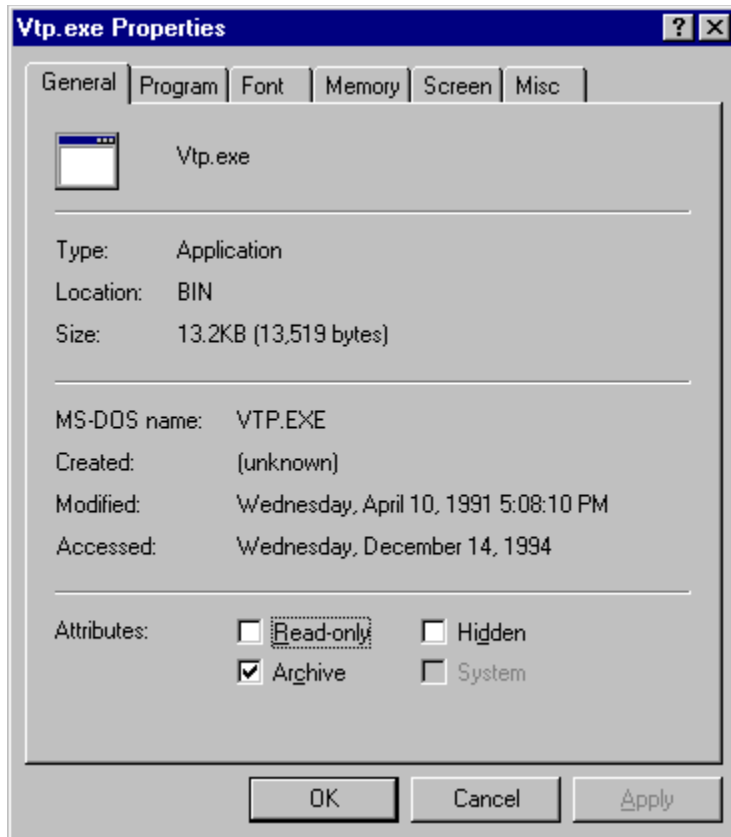

Use the Program properties to identify details about how the program will be run.

Program properties
for an MS-DOS-based application

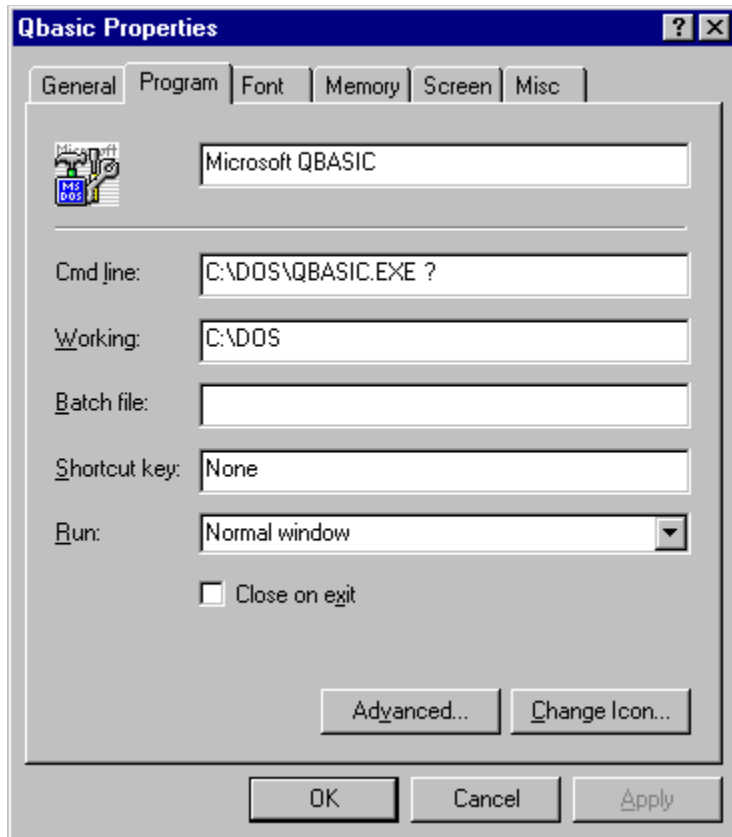

Option	Comments
(Filename)	Include the filename for the application.
Command Line	Type the full command line, including the correct drive, path, and options, to run this application.
Working	Specify the working directory.
Batch File	Type the name of a batch file you want to run before the program starts.
Shortcut Key	Specify the key combination (if any) that you want to use to quickly switch to this application.
Run	Choose whether to run the program in a normal-sized window, a maximized window, or a minimized window.
Close on Exit	Check this box if you want the window to close after the MS-DOS-based program has ended.

Use the Advanced command button to specify information about the mode in which your program will run.

Advanced properties for an MS-DOS-based application

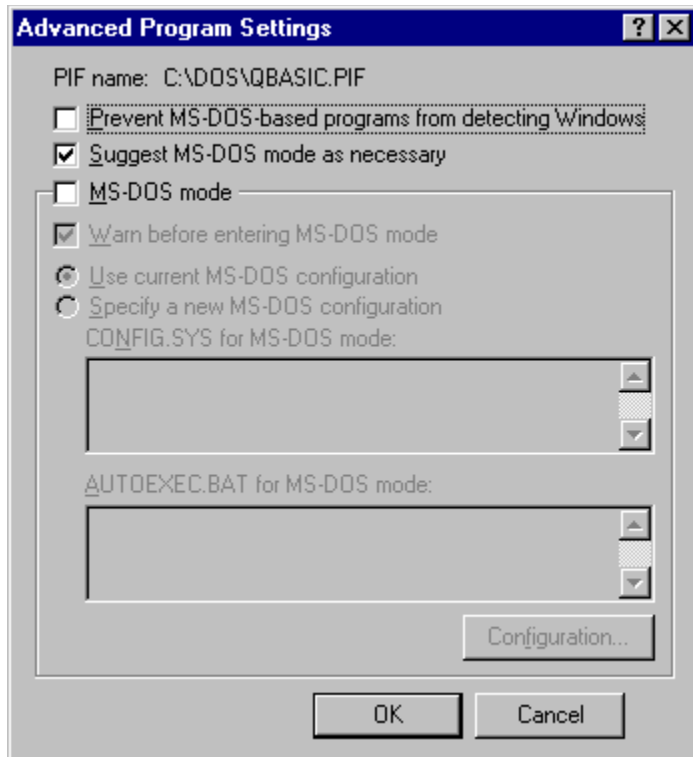

Option	Comments
Prevent MS-DOS-based Programs From Detecting Windows	Check this box to hide Windows 95 from MS-DOS-based applications for those applications that cannot run or that perform poorly if they detect the presence of Windows 95.
Suggest MS-DOS Mode As Necessary	Check this box to allow Windows 95 to detect whether MS-DOS-based applications run best in MS-DOS Mode. If it detects such an application, Windows 95 runs a wizard to set up a custom command to run the application.
MS-DOS Mode	Check this box to run this program in exclusive MS-DOS Mode. No other processes are allowed to run simultaneously if you use this option.
Warn Before Entering MS-DOS Mode	Check this box to enable the automatic warning presented when Windows 95 is about to run an application that requires MS-DOS Mode and must shut down all other applications. If this option is checked, Windows 95 will warn the user before beginning the shutdown process.
Specify A New MS-DOS Configuration	Check this box to edit the CONFIG.SYS and AUTOEXEC.BAT files in the corresponding text boxes or by clicking the Configuration button.
CONFIG.SYS For MS-DOS Mode	Type any lines you want to add to CONFIG.SYS to allow this application to run properly. This version of CONFIG.SYS is used only for the MS-DOS Mode session in which this application runs.

AUTOEXEC.BAT For MS-DOS Mode Type any lines you want to add to AUTOEXEC.BAT for this application. This version of AUTOEXEC.BAT is used only for the MS-DOS Mode session in which this application runs.

As shown in the preceding table, you can set the path for a specific MS-DOS-based application that runs in MS-DOS Mode in the AUTOEXEC.BAT box. For MS-DOS-based applications that don't run in MS-DOS Mode, you can only set a working directory. You can set a global path for all MS-DOS-based applications by adding a path statement in AUTOEXEC.BAT. You can also write a batch file that sets a path for an MS-DOS-based application; for example:

```
path=%path%;c:\utils;c:\norton
```

After you write the batch file, create a shortcut to your MS-DOS-based application, and specify the batch file's path and name in the Batch File field of the Program properties.

From the Font properties, you can specify the font size and type to be used when the MS-DOS-based program runs. From Font properties, you can also preview how the program window and the font will appear.

Font properties for an MS-DOS-based application

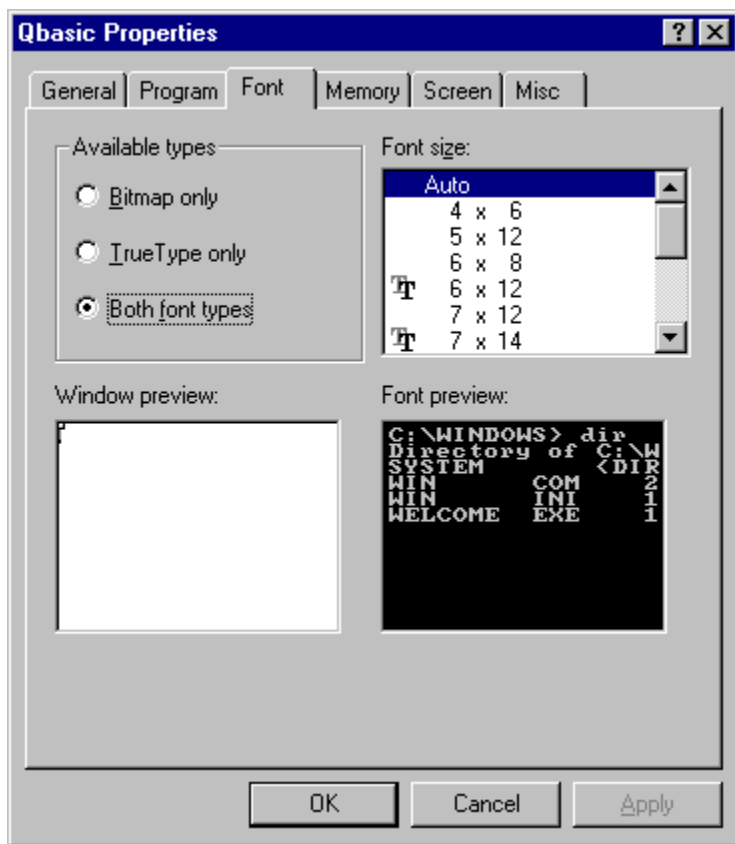

From the Memory properties, you can define the following memory allocation options:

- Conventional memory, which consists of the first 640K of memory available on your computer.
- Expanded memory, which can be installed as an expanded memory card or emulated by an expanded memory manager (EMM). EMM software maps pages of expanded memory onto the system's upper memory area.
- Extended memory, which is essentially a seamless upward extension of the original 1-MB address space available in the memory of 80286 and 80386 computers. Extended memory always starts at exactly 1024K, where the upper memory area ends.

- MS-DOS protected-mode memory, which Windows 95 automatically provides as expanded memory for MS-DOS-based applications that require it to run. It cannot provide this memory, however, if you include a statement in CONFIG.SYS that loads EMM386.EXE with the **noems** parameter. Use the **ram** parameter when loading EMM386.EXE in CONFIG.SYS, or use the **x=mmm-nnn** statement to allocate enough space in the upper memory area for Windows 95 to create an EMS page frame.

Using Upper Memory Blocks (UMBs) and High Memory Area (HMA) are two ways to free conventional memory for use by MS-DOS-based applications, and thus improve performance. In conventional memory, UMBs are the unused part of upper memory from 640K to 1 MB, where information can be mapped to free memory below 640K. HMA is the first 64K of extended memory, where drivers can be loaded to free conventional memory.

Memory properties
for an MS-DOS-based application

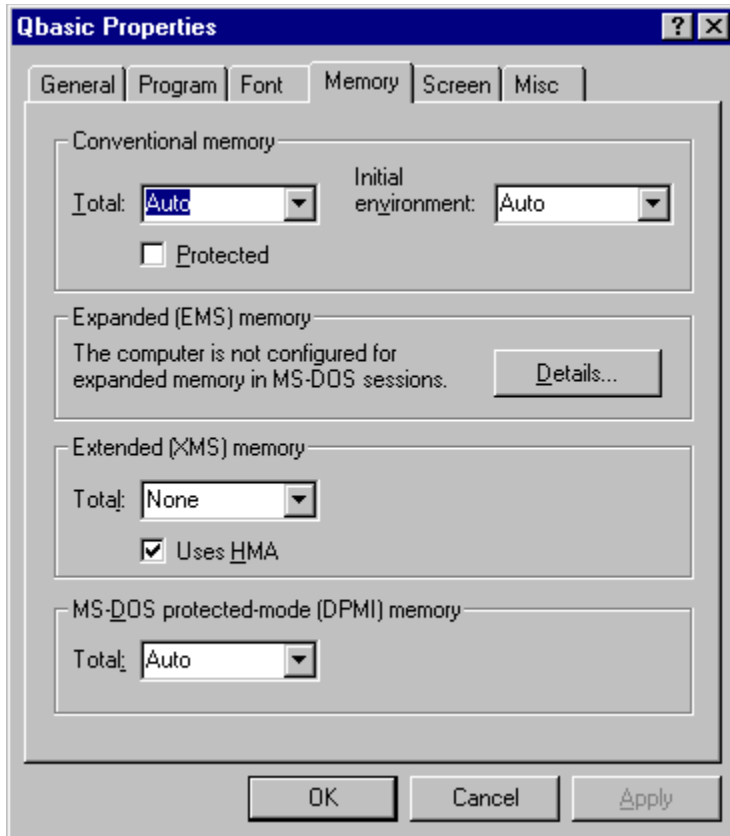

From the Screen properties, you can specify options for how the application will be displayed.

Screen properties for an MS-DOS-based application

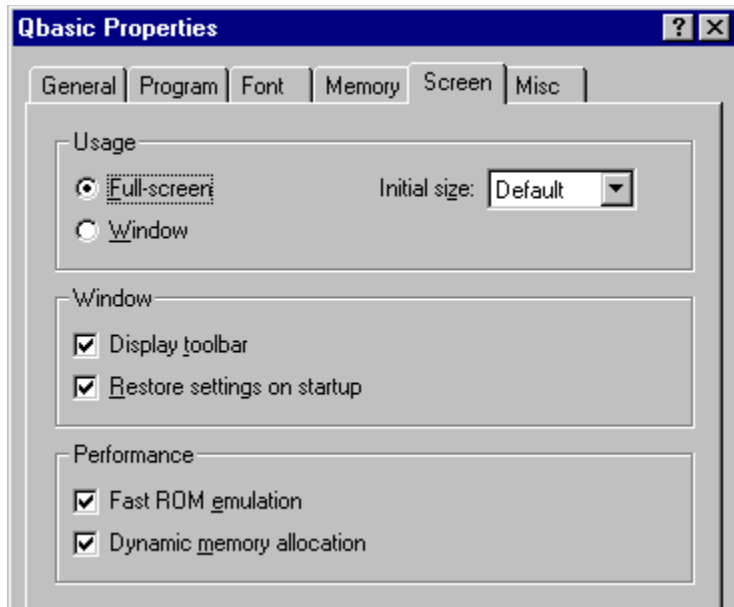

Option	Comments
Usage	Specify whether the application will run in a window with an initial size you can specify, a full-screen window, or a window with a size automatically determined by the graphic mode it uses.
Windows	Choose whether to display a toolbar or to preserve the previous Windows 95 window settings.
Performance	Choose Dynamic Memory Allocation to use the Windows 95 video ROM-handling capabilities. Choose Fast ROM Emulation to enable VxD emulation of selected video ROM services and to speed up video operations, particularly text output.

From the Misc properties, you can specify details about running your program in the foreground and in the background. You can specify whether your program must have exclusive access to the system when it is in the foreground and whether running a screen saver is allowed when the program is active. You can also specify whether the program must be suspended when it is in the background.

In addition, you can specify preferences for mouse, idle sensitivity, Windows hot keys, and other options.

Miscellaneous properties for an MS-DOS-based application

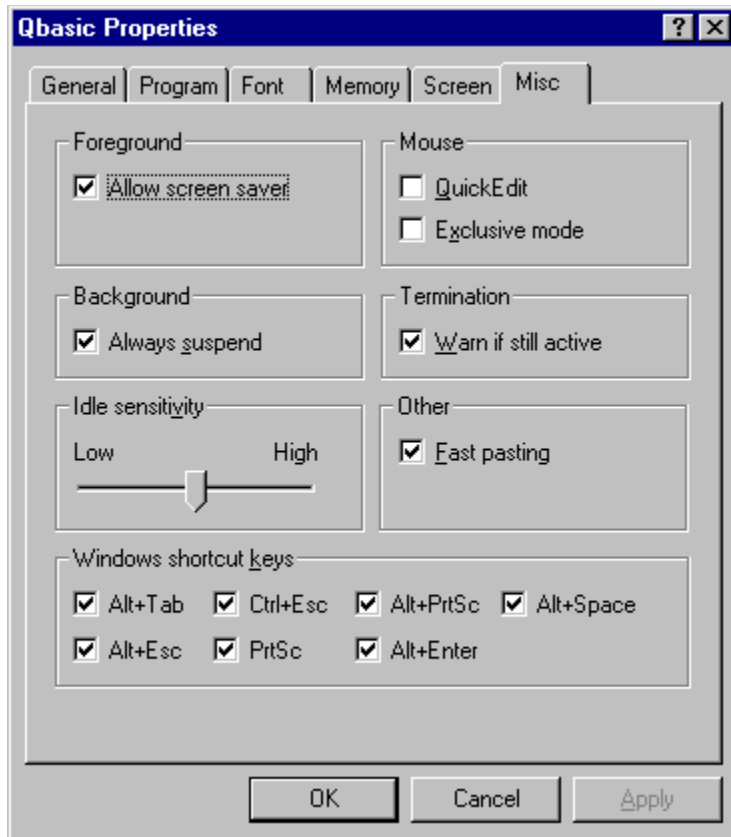

In Windows 95, the Properties dialog box replaces PIF Editor, which was used in earlier versions of Windows to optimize the settings for MS-DOS-based applications.

For information about changing the properties for executable files, see online Help. For Help on the Properties dialog box of an executable file, click the question mark button at the top of the dialog box, and then click the item you want information about.

Setting Paths for MS-DOS-Based Applications

You can set the path for a specific MS-DOS-based application that runs in MS-DOS Mode by carrying out the following procedure.



To specify a path for MS-DOS-based applications that run in MS-DOS Mode

1. Right-click the application's executable file, and then click Properties.
2. Click the Application tab, and then click Advanced.
3. Make sure MS-DOS Mode is checked.
4. In the AUTOEXEC.BAT For MS-DOS Mode area, specify the correct path.

Note For MS-DOS-based applications that do not run in MS-DOS Mode, you can set only a working directory.

You can set a global path for all MS-DOS-based applications by adding a path statement to AUTOEXEC.BAT. You can also write a batch file that sets a path for an MS-DOS-based application; for example:

```
path=%path%;c:\utils;c:\norton
```

After you write the batch file, carry out the following procedure to ensure that Windows runs it before starting your MS-DOS-based application.



To run a batch file before starting an MS-DOS-based application

1. In the application's properties, click Program.
2. In the Batch File area, specify the batch file's path and name.
3. If you want the VM window in which the batch file is running to close after the batch file has finished, make sure the Close On Exit box is checked.

For more information about commands that can be used in batch files, see [Command-Line Commands Summary](#).

Understanding the APPS.INF File

APPS.INF contains a section named [PIF95] that acts as a master list of settings for MS-DOS-based applications. Each line in this section corresponds to a subsequent entry in APPS.INF that contains information about running that specific application.

Each entry in the [PIF95] section uses the following syntax:

app file=%*title*%, *icon file*, *icon num*, *set working*, *section*, *other file*, *set pif*

Entry	Meaning
<i>app file</i>	The filename, with extension, of the application's executable file.
<i>title</i>	The name that appears in the application's title bar. The string identifier must appear in the [Strings] section of the INF file, set to the quoted name of the application.
<i>icon file</i>	The file from which to extract the application's icon.
<i>icon num</i>	The number from the icon extraction table. The default is 0 .
<i>set working</i>	Allows the computer to automatically set the working directory to the one that contains the executable (0 , the default), or prevents it from doing so (1).
<i>section</i>	The name of the corresponding section in APPS.INF that contains details about this application.
<i>other file</i>	The key file within a directory for this application, used when two <i>app file</i> entries are identically named.
<i>set pif</i>	The value allowing (0 , the default) or preventing (1) creation of a PIF file for this application.

Each section following the [PIF95] section includes entries that define any parameters, any required memory or other options, and options that can be enabled or disabled. For example:

```
[WORD.EXE]
LowMem=384
Enable=cwe
Disable=win,bgd,asp
```

The **Enabled=** and **Disabled=** entries use the following abbreviations. To separate multiple entries, use commas.

Entry	Meaning	Entry	Meaning
aen	ALT+ENTER	eml	EMS memory locked
aes	ALT+ESC	ems	EMS memory
afp	Allow fast paste	emt	Emulate ROM
aps	ALT+PRINT SCREEN	exc	Exclusive mode
asp	ALT+SPACE	gmp	Global memory protection
ata	ALT+TAB	hma	Use HMA
awc	Automatic window conversion	lml	Low memory locked
bgd	Background	mse	Mouse
cdr	CD-ROM	net	Network
ces	CTRL+ESC	psc	PRINT SCREEN
cwe	Close on exit	rvm	Retain video memory
dit	Detect idle time	rwp	Run Windows applications

dos	Real mode	win	Run in a window
dsk	Disk lock	xml	XMS memory locked

Application Support

Using OLE to Share Data Between Applications

Windows 95 includes built-in OLE functionality that enables you to share data between OLE-compliant applications. Using applications that take advantage of OLE technology, you can create OLE documents that contain multiple types of data and that allow you (or other users) to edit or display that data without running other applications.

OLE is a technology built into Windows 95 that improves on the OLE 1.0 standard. It provides services for sharing OLE objects (units of data) and the related functions needed to manipulate that data. In Windows 95, the file STORAGE.DLL manages OLE documents.

Under Windows 95, applications that use OLE technology can use new OLE objects, and new OLE applications can use OLE 1.0 objects. However, in each case, functionality is limited to OLE 1.0. For example, OLE 1.0 does not include in-place interaction, so when you double-click an object in an OLE 1.0 application, the source application starts and the object is displayed in another window.

The new OLE technology provides a way of communicating between container applications and object applications. *Container applications* maintain OLE documents, and *object applications* act as servers to provide various data objects (such as text, bitmaps, spreadsheets, spreadsheet cells, or sound clips) to be included in the OLE document. The container application does not need any information about the object application or its specific data type to communicate with it.

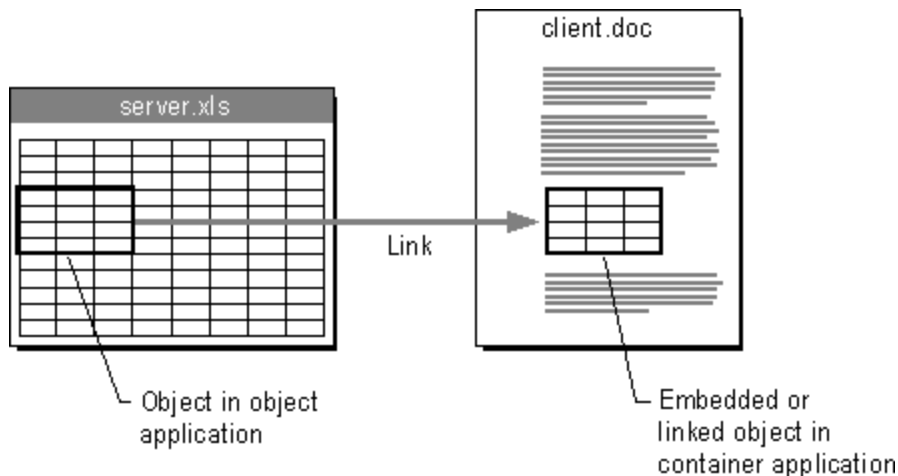

Windows 95 keeps track of OLE objects by keeping an entry for each one in the Registry. Each entry includes a unique identification tag for the object and an application identifier. The application identifier is also used as a class name when OLE objects are placed in OLE containers. For example, "Word.Document.6" is the application identifier for a Word 6.0 document.

Note With ClipBook Viewer, an OLE application that is located in the OTHER\CLIPBOOK directory on the Windows 95 compact disc, you can share OLE objects for use in documents across a network. For more information, see Help in ClipBook Viewer.

OLE objects can be *visually edited*, meaning that users can activate objects and edit, play, or otherwise manipulate them in the location in which they are embedded.

To enable visual editing, both the container application and the object application must be OLE-compliant and must support the OLE visual editing interface. If either the container or the object application (or both) meets only the OLE 1.0 specification, the object application will be launched in its own window for editing. For example, Corel® Draw 4.0 implements some features of OLE that do not include the visual editing interface, so when a Corel Draw 4.0 object is opened for editing, the Corel

Draw 4.0 application will start in its own window.

If an embedded object has a filename extension that is not associated with any application, you may be unable to successfully activate it. You must first associate the file type with an application. For information about associating file types with applications, see online Help.

To move or copy an object, you can drag it from one container to another. When doing so, use the following key combinations.

Mouse Action	Result
Drag and drop	Determined by target and source; usually Move
SHIFT+drag and drop	Move the object
CTRL+drag and drop	Copy the object
SHIFT+CTRL+drag and drop	Link the object from the source to the container

For OLE-compliant applications, when an object is dragged between documents, it automatically becomes embedded in the destination document, unless the data type is the same for both the source and the destination application. In this case, the information is merely placed as native data.

Application Support

Technical Notes on Application Support

This section summarizes technical information about running applications under Windows 95. For information about the supporting system components, see [Windows 95 Architecture](#).

System Changes Affecting Application Support

The following sections describe how system changes affect 16-bit and 32-bit applications and MS-DOS-based applications.

Windows 95 changes the system configuration files, as described in [Setup Technical Discussion](#). The following changes affect application support:

- If no **files=** line is specified in CONFIG.SYS, Windows 95 uses a setting of 60.
- Windows 95 enables file sharing by default. Therefore, it is no longer necessary to add **share.exe** to AUTOEXEC.BAT or **vshare** to SYSTEM.INI.
- Many application settings have moved from INI files to the Registry. If you install an application after Windows 95 is installed, and the setup application writes directly to the WIN.INI and SYSTEM.INI files instead of using documented functions, Windows 95 does not recognize those changes. To resolve this problem, or obtain a version of the application that is designed for Windows 95.

Support for Win32-Based Applications

Applications that use Win32 APIs and are designed for Windows 95 can take full advantage of all Windows 95 performance enhancement features. Win32-based applications feature several benefits over Win16-based applications, including preemptive multitasking, Win32 APIs, long filename support, separate message queues, and memory protection. Each Win32-based application runs in its own fully protected, private address space, preventing it from causing the operating system or other applications to fail and preventing interference from errors generated by other applications. An added benefit is that you can manage files from the Open dialog box in Win32-based applications.

To support preemptive multitasking, the Windows 95 kernel schedules the time allotted for running applications. This results in smoother concurrent processing and prevents any one application from using all system resources without permitting other tasks to run. (An exception is when you run an MS-DOS-based application in MS-DOS Mode, which gives the application exclusive use of system resources.) Win32-based applications can implement threads to improve the level of detail at which they can take advantage of multitasking.

Under Windows 3.1, the operating system passes control to another task, allowing that task to be scheduled cooperatively, at the point when an application checks the system message queue. In this case, if an application doesn't check the message queue on a regular basis, or if the application stops and thus prevents other applications from checking the message queue, the system keeps other tasks suspended until the errant application is ended. Under Windows 95, each Win32-based application has its own message queue and thus is not affected by how other tasks access message queues.

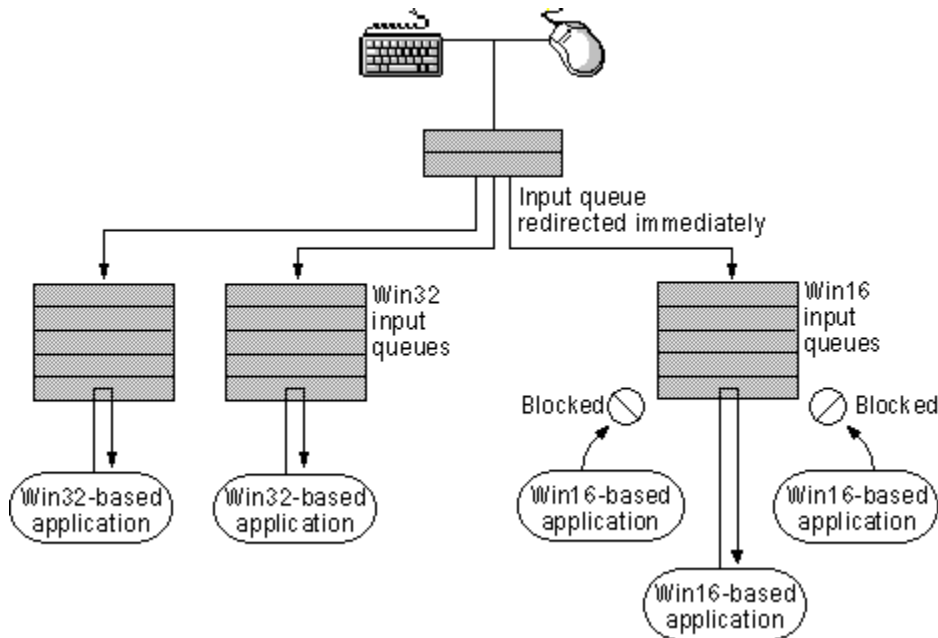

Resources allocated for each Win32-based application tracked on a per-thread basis are automatically freed when the application ends. If an application stops responding, you can press CTRL+ALT+DEL to display the Close Application dialog box, and then close the unresponsive application without affecting other running tasks.

To make the most of Windows 95, your applications should:

- Be Win32-based
- Be OLE-compliant to allow for data sharing with other applications
- Use Remote Procedure Call (RPC) for networked NetBIOS applications
- Use Windows Sockets for networked non-NetBIOS applications

Win32-based applications that run under Windows NT will run well under Windows 95 if the application does not use any Windows NT-specific APIs (such as those for security) or if it has been designed to run under both Windows 95 and Windows NT.

Support for Win16-Based Applications

Win16-based applications designed for Windows 3.1 run under Windows 95 without modification. Windows 95 ensures that any Win16-based application runs on a 4-MB (or greater) computer as well as or better than it did under Windows 3.1. In addition, the performance of Win16-based applications is improved because it can use operating system services provided by the 32-bit system components of Windows 95, including 32-bit device driver components and 32-bit subsystems.

Windows 95 provides the same system resources to both Win32-based and Win16-based applications, but Win16-based applications cannot take advantage of preemptive multitasking. Win16-based applications share memory, a common input queue, and a common message queue, and their processes are scheduled cooperatively.

Win16-based applications benefit from preemptive multitasking of other system components, including the 32-bit print and communications subsystems and improvements made in system robustness and protection for the Windows 95 system kernel.

Because all Win16-based applications run in the same virtual machine (VM), an errant application can cause other Win16-based applications to fail, but shouldn't adversely affect Win32-based applications. However, the improvements made to overall system-wide robustness significantly increase the system's ability to recover from an errant application and improved cleanup of the system lessens the likelihood of application errors. Windows 95 tracks resources allocated by Win16-based applications and uses the information to clean up the system after an application exits or ends abnormally, thus freeing up unused resources that the rest of the system can use. If an application does fail, you can press CTRL+ALT+DEL to display the Close Application dialog box, and then close the unresponsive application without affecting other running tasks, as described in [Closing Failed Programs](#).

Note Win16-based applications cannot use long filenames. The Windows 95 file system should preserve long filenames while you use a Win16-based application to edit files. However, you will lose long filenames if you copy files from within existing Win16-based applications such as user interface replacements.

Application Support

Technical Notes on Application Support

System Changes Affecting Application Support

Support for MS-DOS-Based Applications

Windows 95 includes many improvements over Windows 3.1 for running MS-DOS-based applications, including better printing support and improved capabilities for running hardware-intensive applications such as games.

As with Windows 3.1, each MS-DOS-based application runs in its own virtual machine (VM), which allows multiple 8086-compatible sessions to run on the CPU. This, in turn, allows existing MS-DOS-based applications to run preemptively with the rest of the system. The use of virtual device drivers (VxDs) provides common regulated access to hardware resources. Each application running in a VM appears to run on its own individual computer; this allows applications that were not designed for multitasking to run concurrently with other applications.

VMs are protected from each other, and from other running applications. This prevents errant MS-DOS-based applications from overwriting memory that is occupied or used by system components or other applications. If an MS-DOS-based application attempts to access memory outside its address space, the system notifies the user and ends the MS-DOS-based application.

One of the major difficulties MS-DOS-based applications had in the VMs in earlier versions of Windows was insufficient conventional memory space. By the time MS-DOS-based device drivers, TSR applications, and networking components were loaded with Windows, there often wasn't enough conventional memory left to allow the MS-DOS-based application to load or run. Windows 95 provides 32-bit, protected-mode driver components that replace many 16-bit, real-mode device driver and TSR counterparts, improving overall system performance and using no conventional memory. The memory savings with protected-mode components can be significant. For example, a computer using only Windows 95 protected-mode components would save more than 225K of conventional memory over the amount used by real-mode networking software, drivers for a mouse and SCSI CD-ROM drive, and SMARTDrive.

How Windows 95 Accommodates Application Problems

Some Windows-based and MS-DOS-based applications may not run well under Windows 95 because they were written to take advantage of characteristics of older operating systems. For example, certain applications use a portion of the title bar to include items other than the title, such as a Quick Help button. Because Windows 95 title bars are not formatted in the same way as Windows 3.x title bars, some information may be overwritten when you run these old applications.

In addition, some applications use interrupts that are not automatically supported by Windows 95. Others do not handle long filenames well, or incorrectly check for the operating system's version number.

Windows 95 provides a utility to make an application that is incompatible with Windows 95 compatible. You can use this utility to troubleshoot if you have trouble printing from an application or an application stalls or has other performance problems. It provides a means to switch from EMF to RAW printer data, to increase stack memory to an application, to emulate earlier versions of Windows, and to solve other common problems that cause an application not to run with Windows 95. For more information, see online Help.



To run the Make Compatible utility

- Click the Start button, click Run, and then type **mkcompat.exe**

Notes Many programming tools that are not specifically designed to run under Windows 95 may run satisfactorily, but the corresponding debugging tools usually do not. Make sure that both the programming and debugging tools you use are designed for Windows 95.

Some Win16-based and MS-DOS-based disk utilities must be run with special care. In addition, some disk utilities do not perform correctly with long filenames. For more information about using Win16-based and MS-DOS-based disk utilities with Windows 95, see [Disks and File Systems](#).

Application Support

Technical Notes on Application Support

How Windows 95 Accommodates Application Problems

Running TSRs

Some older TSRs rely on MS-DOS interrupts to monitor everything that happens on the system. However, because of its protected-mode file system, Windows 95 doesn't use MS-DOS interrupts. If Windows 95 detects that a TSR is trying to monitor these interrupts, it will accommodate the application and will send all system information through MS-DOS interrupts. This way, the TSR can monitor system events successfully. However, doing this will slow the performance of the operating system significantly.

The IOS.INI file, as described in [Devices](#), includes a list of "safe" drivers and applications. If Windows 95 finds the application listed in IOS.INI, it will not send system events through MS-DOS interrupts, thus avoiding slowed performance.

Fixing Version-Checking Errors

If you are using an MS-DOS-based application that was designed for an MS-DOS version other than 7.0 (which is the version that Windows 95 reports), you may receive a message that says you are not using the correct version of MS-DOS. If this is the case, you can add the application to the version table. The version table contains a list of executable files followed by the version number of MS-DOS that the applications were designed to run with.

To display the version table, type **setver** in a command prompt window. For information about the syntax, parameters, and switches you can use to add an application to the version table, type **setver /?** at the command prompt.

Windows 95 cannot report the correct MS-DOS version to applications unless the version table is loaded into memory. To load the version table, include a **device** command in CONFIG.SYS; for example:

```
device=c:\windows\setver.exe
```

If you modify the version table or CONFIG.SYS, restart the computer so the changes can take effect.

Some applications incorrectly check the version number of Windows 95. Incorrect version-checking techniques sometimes invert the two bytes that record the version number; thus, version 3.10 would be reported as 10.3. Windows 95 tries to accommodate this possible version-checking error by reporting 3.95 as the version. This way, if an application looks for a version greater than 3.10 or its inverse, 10.3, the new Windows 95 version will prove to be greater.

If the application looks for an exact match for the version number, such as Windows version 3.10, it may not run under Windows 95. To resolve this problem, add the following line to the [Compatibility] section of the WIN.INI file:

```
compiled_module_name=0x00200000
```

To determine the compiled module name, right-click an executable file in Windows Explorer, and then click Quick View. The Module Name line provides this information. After you have obtained the module name, the section you add to the WIN.INI file should look similar to this entry for cc:Mail™:

```
[Compatibility]  
CCMAIL=0x00200000
```

Windows 95 Setup adds entries to the WIN.INI file for many applications that are known to have this problem.

Note Do not add a permanent entry to WIN.INI for an installation application. Install your application first, and then edit the compiled module name in WIN.INI.

If a setup application incorrectly detects the version of Windows 95, you may be unable to install the application. In this case, add an entry to the [Compatibility] section of WIN.INI for the setup application (for example, SETUP=0x00200000). Install the application, and then immediately remove the section that you added to WIN.INI.

Application Support

Technical Notes on Application Support

How Windows 95 Accommodates Application Problems

Running Applications That Replace System DLLs

Some setup applications do not check the version of the system files they are installing and overwrite the newer Windows 95 versions of those DLLs. Windows 95 restores its original DLLs after every setup application runs and for the first three startups thereafter. If an application stops running or behaves erratically after you install it, you may need to obtain an updated version of the application that does not overwrite Windows 95 system files.

Earlier versions of Windows allowed applications to redistribute parts of the system with no ill effects. For example, an application might overwrite a system file with no adverse consequences.

In Windows 95, multiple system files have been consolidated to expedite the startup process. If an application tries to overwrite a system file that is no longer used, Windows allows the application to copy the file, but does not use it.

If your application must run with a replacement file, you can add that file to the Windows SYSTEM\MM32 directory (which is initially empty after you set up Windows 95).

After you install an application, Windows 95 checks for files that are commonly overwritten by setup applications. If any are found, a dialog box appears, enabling you to restore the files from the hidden Windows SYSBACKUP directory.

Troubleshooting Applications

Hot keys fail to start applications.

In Windows 95, you cannot use hot keys to run applications located on the desktop. You can use hot keys to run only those applications located in the Applications folder. To start an application that is located on the desktop, double-click its icon.

You cannot create a shortcut.

If you try to add an application to the Start menu by dragging the application's icon to the Start button, you may receive a message that says that you cannot create a shortcut. The message prompts you to place the shortcut on the desktop. This message appears if the Start Menu directory is corrupted or deleted.



To repair a corrupted or missing Start Menu directory

1. Click the Start button, and then click Shut Down.
2. Click Restart The Computer.

This creates a new Start Menu folder. If you continue to receive an error message when dragging items to the Start button, delete the Start Menu directory in My Computer or Windows Explorer, and then repeat this procedure.

.LNK extensions are never displayed.

Windows 95 never displays the .LNK extension, even if you choose Show All Files on the View tab of the Options dialog box in My Computer or Windows Explorer.

A disk utility cannot write to a disk.

Windows 95 does not support MS-DOS-based or Windows 3.1-based utilities that perform direct disk writes. Direct disk writes using the MS-DOS read sector (INT 26h) or absolute read sector (INT 13h) interfaces will fail unless the application has locked the volume for exclusive use. For information, see [Disks and File Systems](#).

You can't print from an application.

If you cannot print from an application, you can bypass spooling by sending printer output to a file and then dragging that file to a printer. For information about printing to a file, see [Printing and Fonts](#).

The taskbar is hidden.

Whenever you maximize an application, Windows 95 resizes the window so it does not cover the taskbar. However, if an application maximizes itself by using screen metrics to resize its window to take up the entire screen, the taskbar may be obscured. Because this type of application commonly has problems with the taskbar, Windows 95 hides the taskbar when this occurs, giving the application the entire screen. To display the taskbar, manually resize the application's window or minimize the application. To display the Start menu, press CTRL+ESC.

An application on a compressed drive lacks enough memory to run.

Applications that require maximum available conventional memory should not be run on compressed drives. You might need to run such applications in MS-DOS Mode.

Running an MS-DOS-based application causes Windows 95 to stall during startup.

To restore Windows 95, shut down and restart the computer, and then press F8 when the Starting Windows 95 message appears. In the Windows 95 Startup menu, select the option named Previous Version of MS-DOS. (This option does not appear unless you edit MSDOS.SYS, as described in [Setup Technical Discussion](#).) Remove the following lines in AUTOEXEC.BAT by typing REM before them:

```
rem cd c:\windows\command
rem call c:\windows\command\<game.exe>
rem c:\windows\win.com/wx
```

Remove the following line in CONFIG.SYS by typing **rem**:

```
rem dos=single
```

Text on menus and other screen elements is truncated.

Applications that depend on the system font to be a certain size may truncate the text on menus and other screen elements if the text is larger than the default setting. This may occur if users customize their screen fonts. To resolve this problem, right-click the desktop, and then click Properties. Click the Appearance tab, and then, in the Scheme list, click Windows Standard.

Strange colors and patterns appear on the desktop.

Some Windows 3.1-based applications hook into the desktop so they can be aware of all the events that take place there. When all applications were minimized in Windows 3.1, the desktop was the background area. In Windows 95, however, the background area is always covered by the new Windows 95 shell. Applications that subclass the old desktop no longer monitor any activity. If such applications attempt to draw on the old background, images will appear on the new desktop, but they will conflict with images that the Windows 95 interface draws there. Users will be unable to interact with the images such applications draw.

This problem typically occurs with screen background/wallpaper applications and with replacement user interfaces, typically located in the StartUp folder. These types of applications may also be started by **run=** or **load=** lines in WIN.INI.

To resolve this problem, remove the application from the StartUp folder or remove its entry in the WIN.INI file. Or obtain a version of the application designed for Windows 95.

Setup program cannot create shortcuts.

Because of cooperative multitasking in Windows 3.1, Program Manager was always guaranteed to respond within a few seconds of a DDE message. For that reason, many setup applications set the DDE timeout to a very short interval. In some cases, Windows 95 may be unable to process the DDE request in the same time period due to preemptive multitasking. Setup applications may be unable to create an application group or shortcuts for this reason. If this occurs, you can manually add folders and shortcuts to the Programs menu. For more information, see online Help.

You need to rebuild the Programs menu.

If Windows components are inadvertently deleted from the Programs menu, you can rebuild the menu. When you do, Windows 95 searches for installed components and adds shortcuts for them to the Programs menu. To rebuild the Programs menu, first rename SETUP.OLD to SETUP.INI. Then click the Start button, click Run, and type **grpconv -s** in the Open box.

For information about manually rebuilding the Programs menu, see online Help. For more information about **grpconv**, see [Setup Technical Discussion](#).

You need to save a Notepad or WordPad file using an unassociated filename extension.

If you are saving a file in Notepad or WordPad and you specify a filename extension that has not been associated with an application, Notepad or WordPad will append the default filename extension to the end of the filename. Notepad uses the extension .TXT, and WordPad uses the extension .DOC.

To save a file using a filename extension that is not in the Registry, enclose the filename in quotation marks.

Introduction

This chapter describes the Windows 95 printing subsystem and explains how to set up printers with Windows 95. It also presents an overview of font support in Windows 95.

- [■ Windows 95 Printing and Fonts: The Basics](#)
- [■ Printing and Fonts: The Issues](#)
- [■ Windows 95 Printing Support Overview](#)
- [■ Installing a Printer](#)
 - [■ Installing Plug and Play Printers](#)
 - [■ Installing Remote Printers with Point and Print](#)
- [■ Printing Documents](#)
- [■ Using Microsoft Print Services for NetWare](#)
- [■ Using DEC PrintServer Software for Windows 95](#)
- [■ Using the Hewlett-Packard JetAdmin Utility](#)
- [■ Using the Microsoft RPC Print Provider](#)
- [■ Technical Notes on Windows 95 Printing](#)
 - [■ Enhanced Metafile Spooling Support](#)
 - [■ Bidirectional Communication Support](#)
 - [■ Printer Driver Support](#)
 - [■ Extended Capabilities Port Support](#)
 - [■ Improved Printing Support for MS-DOS–Based Applications](#)
 - [■ Deferred Printing Support](#)
 - [■ Image Color Matching Support](#)
- [■ Windows 95 Fonts Overview](#)
- [■ TrueType Fonts](#)
- [■ Windows 95 Raster Fonts](#)
- [■ Windows 95 Vector Fonts](#)
- [■ Screen and Printer Fonts](#)
- [■ Fonts Provided for Compatibility](#)
- [■ Font Matching Table](#)
- [■ How Fonts Are Matched in Windows 95](#)
- [■ Loading Fonts in Windows 95](#)
- [■ Installing Additional Fonts](#)
- [■ Troubleshooting Printing Problems](#)
 - [■ Correcting Problems with Printer Installation](#)
 - [■ Correcting Specific Printing Problems](#)
- [■ Troubleshooting Font Errors](#)

Windows 95 Printing and Fonts: The Basics

Windows 95 significantly improves the printing and font capabilities of Windows version 3.x by including the following features.

32-bit printing subsystem with bidirectional communication.

The Windows 95 printing subsystem is compatible with the Windows NT printing subsystem, including monitors that facilitate bidirectional communication with printers.

Quicker “return to application” time.

Background spooling and the use of enhanced metafile (EMF) spooling significantly decreases the time it takes to return control to the application, depending on job content.

Better conflict resolution.

Spooling from MS-DOS-based applications solves conflicts when multiple applications, or applications based on both MS-DOS and Windows, are trying to print at the same time.

Point and Print support.

Point and Print support allows users to automatically install a driver for a network printer and print to a network printer. Point and Print support is available for Windows 95, Windows NT, and Novell® NetWare® printers.

Microsoft Print Services for NetWare.

This feature allows you to direct print jobs from a NetWare server to printers attached to computers running Windows 95.

Image Color Matching.

Image Color Matching (ICM) allows applications to better match the color of images displayed on the screen with those generated by an output device.

Deferred printing support.

Deferred printing allows mobile and other users to generate print jobs when they are not connected to a printer. The print jobs are stored on the computer until a printer becomes available. Windows 95 detects the connection and automatically spools the print jobs as a background process.

Extended capabilities port.

Support for parallel extended capabilities ports (ECP) allows Windows 95 to print at high speeds and work with ECP devices. Even if you do not have an ECP device, using an ECP parallel port will improve I/O performance.

Greater font flexibility.

Because the fonts are stored in the Registry, you can install an unlimited number of TrueType® fonts. In addition, you can print almost 1000 fonts in any document.

Support for raster, vector, and TrueType fonts.

As with earlier versions of Windows, Windows 95 supports raster, vector, and TrueType fonts.

Improved font handling.

Windows 95 handles downloadable soft fonts and font substitutions, and better integrates font handling with the Windows 95 user interface, which is optimized for the 32-bit environment. Windows 95 also includes an enhanced rasterizer for more accurate rendering and generating of TrueType fonts.

Printing and Fonts: The Issues

Before configuring printers and installing fonts in Windows 95, you should consider the issues summarized in this section.

To share a printer on either Microsoft or NetWare networks, the computer must be running a 32-bit, protected-mode client, and File and Printer Sharing services must be enabled. For information, see [Logon, Browsing, and Resource Sharing](#).

The following are general issues for printing:

- With Point and Print, users can install printers over the network if the print server includes drivers specified in the Windows 95 INF files. You need to designate which computers are running Windows 95 and which network servers will function as print servers, and configure them to store Point and Print information.
- When purchasing new printers, consider those with support for bidirectional communication and ECP ports.
- ECP ports are not automatically configurable. If your computer includes an ECP, follow the procedure [Enhanced Metafile Spooling Support](#) to enable ECP support.
- If your printer uses font cartridges, you will also need to install the fonts on your computer.

The following are issues for printers on NetWare networks:

- To take advantage of the Win32-based NetWare print service capability, the computer must be running Microsoft Client for NetWare Networks. However, the computer does not need to run File and Printer Sharing services.
- To use Point and Print with NetWare servers, you must decide which servers will store printer driver files. You can store pointers in the NetWare bindery to the servers that have printer driver files installed on them. For information, see [Installing Remote Printers with Point and Print](#).

Windows 95 Printing Support Overview

In Windows 3.1, print spooling functionality was handled by Print Manager and supported by code in several different Windows-based components. The Print Manager passed a fixed amount of information to the printer whether the printer was ready to receive it or not, causing what seemed to be jerky processing.

In Windows 95, the print spooler is implemented as a series of 32-bit virtual device drivers and DLLs, and consolidates the spooler functionality into a single architecture. The new spooler provides smooth background printing by using background thread processing. This means that the spooler passes data to the printer only when the printer is ready to receive more information.

The new spooler provides quick return-to-application time and is much more powerful and flexible. It allows you to set printer properties on a per-printer basis instead of requiring global printing properties as in Windows 3.1. For example, each printer can have a different separator page and each can specify whether jobs will be printed directly or to a queue.

The following diagram illustrates how Windows 95 prints documents.

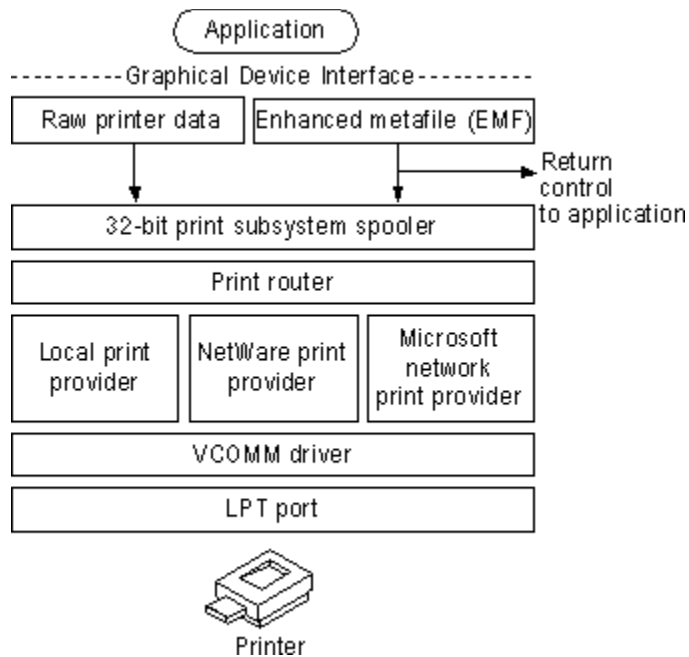

For information about enhanced metafiles, printer drivers, ECP, and other components of the printing subsystem, see [Technical Notes on Windows 95 Printing](#). The following sections describe how to install and share printers and how to use print servers on Windows NT and NetWare networks.

Installing a Printer

Windows 95 uses a new INF format for printer installation. Although the previous OEMSETUP.INF file format is still supported for compatibility with previous versions of Windows, the new format offers added functionality, including support for installing printing subsystem components, such as the printer driver and port monitor, and for installing Plug and Play printers. All information about an installed printer is stored in the Registry.

You can install printers in Windows 95 in the following ways:

- During or after Setup using the Add Printer wizard
- During Setup when using custom setup scripts, as described in [MSBATCH.INF Parameters](#)
- With Point and Print
- With Plug and Play

If you are upgrading from an earlier version of Windows, Windows 95 Setup automatically migrates all previously installed printers. If no printer was previously installed, Windows 95 Setup runs the Add Printer wizard to let you install a printer.

Windows 95 provides the Add Printer wizard to simplify installing printers and a central place the Printers Folder for running the wizard and for managing printing processes. You can open the Printers Folder in the following ways:

- From the Start menu, point to Settings, and then click Printers
- In My Computer, double-click the Printers Folder
- In Control Panel, double-click the Printers icon

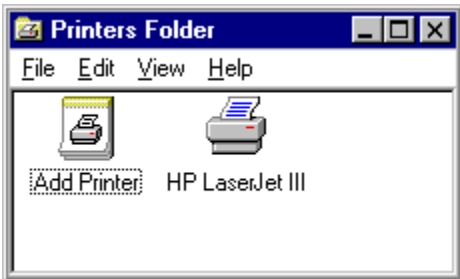

To install a printer with the Add Printer wizard

- In the Printers folder, double-click the Add Printer icon. The Add Printer wizard leads you through the process of setting up and configuring a printer. The process is simpler than earlier versions of Windows because of Windows 95 Point and Print capability, as described in [Installing Remote Printers with Point and Print](#).

The only difference between installing a remote printer and a local printer with the Add Printer wizard is that you must specify the path name to the remote printer or browse to find its network location.

Note You can also start the Add Printer wizard by double-clicking a printer on a print server or on a computer running Windows 95.

Printing and Fonts

Installing a Printer

Installing Plug and Play Printers

For Plug and Play-compliant printers, all you need to do is plug the printer cable into a port and start Windows 95. The printer reports its device ID to Windows 95, which searches INF files to find the ID that matches the values reported by the printer and then proceeds with installation in the following ways:

- If an exact match is found, Windows 95 automatically installs the correct printer support.
- If an exact match is not found, but a compatible driver is found, Windows 95 displays a dialog box showing the device was found and a compatible driver is available. You can then provide a disk containing a Windows 95 driver that is an exact match, ask Windows 95 to install the compatible driver it has found, or ask Windows 95 not to install a driver at all. Windows 95 automatically determines the best driver to use.

Installing Remote Printers with Point and Print

Point and Print allows users to install a printer over a network by providing printer driver information. A user “points” to a print server, that is, opens its print queue by using Network Neighborhood, by typing its path name in the Run dialog box on the Start menu, or by starting the Add Printer wizard. Windows 95 retrieves printer-specific information from the server. The type of information retrieved depends on the type of print server to which you connect, and can include the following:

- Printer driver files
- The name of the server on which printer driver files are stored
- Printer model information, which specifies which printer driver to retrieve from the Windows directory on a local computer or on the network

Windows 95 print server.

A computer running Windows 95 can function as a print server by providing printer drivers and settings (paper size, memory, page orientation, and so on) to another computer running Windows 95. You must share the printer, enabling File and Print Sharing services for either Microsoft networks or NetWare networks. You can apply user-level security to the shared printer. For information, see [Logon, Browsing, and Resource Sharing](#) and [Security](#).

Windows NT print server.

A computer running Windows 95 can connect to a Windows NT 3.1 or 3.5 server to retrieve Point and Print information. The printer model name on the Windows NT server must have the same printer model name in the Windows 95 INF files. If the printer model names are the same, Windows 95 installs the printer driver files from the directory on the local computer or network location from which Windows 95 was installed. If the names are not the same, Windows 95 prompts you for the printer model. Printer settings are not retrievable on a Windows NT print server, so you need to adjust printer settings such as paper size on the computer running Windows 95.

Notice that a Microsoft Windows NT Client Access License is required if the computer will be connecting to servers running Windows NT Server. For information, see [Windows 95 on Microsoft Networks](#) or contact your Microsoft reseller.

NetWare print server.

A computer running Windows 95 can connect to an appropriately configured NetWare server to retrieve printer driver files. You can configure a NetWare print server to store printer driver files in the NetWare bindery or store references in the bindery to other servers that store the printer drivers. To configure the NetWare printer server, you must have Supervisor privileges on the server, and the client computer must be running Client for NetWare Networks.

When requested, the NetWare server automatically copies the printer drivers to the specified path on the computer running Windows 95. Notice that you should specify the driver path before you specify a model name. Because printer settings are not retrievable on a NetWare print server, you need to adjust printer settings, such as paper size, on the computer running Windows 95.



To configure the NetWare server to store Point and Print information

1. Right-click Network Neighborhood, and then click Find Computer.
2. In the Find Computer dialog box, type the name of the print server. When it is found, double-click its icon in the name list box.
3. In the server's dialog box, double-click the icon for the printer. The print queue for that printer appears.
4. Select the print queue, click the File menu, and then click Point And Print Setup.
5. In the context menu, click Set Driver Path.
6. Type the UNC path (in the form `\\server\volume\directory`) for the driver files. For example:
`\\novsvr\sys\drivers\epson24`
7. Copy the appropriate files (as specified in MSPRINT.INF) to the printer path.

8. In the context menu, click Set Printer Model.
9. In the Select dialog box, click the printer manufacturer in the Manufacturers list, and the printer in the Models list. Click OK.



To use Point and Print to connect to a NetWare printer

1. In Network Neighborhood, double-click the NetWare server icon.
2. Drag and drop the print queue from the NetWare server window to your Printer Folders window.
3. Follow the online instructions. The Add Printer wizard prompts you to type a name for this printer.
Windows 95 automatically copies the files for the printer driver (including .DRV, .DLL, .HLP, and other files, as needed) to the Windows SYSTEM directory.

If the print server you're using doesn't support Point and Print, you can use the Add Printer wizard to select the printer driver you want to install.

Note Some printers take advantage of the built-in bidirectional communication ability (Bidirectional Communication Support) and initially configure device driver settings, such as available fonts and the amount of installed memory, without any user intervention.

Printing Documents

In Windows 95 you can print documents in two ways.



To print a document

- If the document is open, from the File menu, click Print.

-Or -

If the document is not open, drag and drop the document onto the printer icon for either a locally installed printer or a network printer. The printer icon can be in the Printers folder or on the desktop.

With the Microsoft protected-mode network clients and networks from other vendors supporting UNC paths, you no longer need a physical redirection to a network printer in order to print.



To print a document to a network printer

1. In Network Neighborhood, double-click a network printer to open its printer queue, or click an icon for a network printer in the Printers Folder.
2. Drag and drop a document onto the printer queue or icon.

Some 16-bit applications do not work with UNC printer names. If you use a network client that does not support UNC connections, or if you need to have a redirected LPT port to support printing from a particular application, you can still make a connection to a printer by using the appropriate network commands (such as **net use lpt1: \\server\printer** or **capture lpt1:**). You can also redirect a port in the Add Printer wizard.

Tip You can quickly locate a printer on a particular server by choosing Run from the Start button, and then typing the server name (for example, **\\myserver**). You will be logged on to the server and prompted for a password, if needed. Then a Windows Explorer window appears so you can select the printer.



To view documents waiting to be printed

- Double-click the icon for the printer.

This shows the print queue and the print jobs it contains.

If you have administrative privileges for the printer, you can use the print queue dialog box to manage the printer queue and print jobs remotely. For example, you can pause and purge printer queues.

Tip You can use WinPopup to receive a message from a printer that a print job is done. For information about how to use WinPopup, see [Network Technical Discussion](#).



To change printer settings

- Right-click the printer icon, and then in the context menu, click Properties.

The settings you can change depend on the type of printer you have.

Tip For easy access to a printer, use the right mouse button to drag the printer's icon from the Printers folder to the desktop, and then click Shortcut on the popup menu that appears. Then you can quickly print a document by dragging the document icon onto the printer icon.

Using Microsoft Print Services for NetWare

Windows 95 includes a Win32-based utility called Microsoft Print Services for NetWare (MSPSRV.EXE), which has some of the capabilities of a NetWare PSERVER. This utility allows a NetWare server (version 2.15 or later) to direct print jobs (despool) to computers running Windows 95. The computer running Windows 95 must also be running Microsoft Client for NetWare Networks, but does not need to run File and Printer Sharing for NetWare Networks.

A NetWare PSERVER must be a dedicated computer unlike a computer running Windows 95 with Microsoft Print Services for NetWare that runs in the background using no resource except for data packet polling at a set interval. This means it won't interfere with other things the user wants to do on that computer.

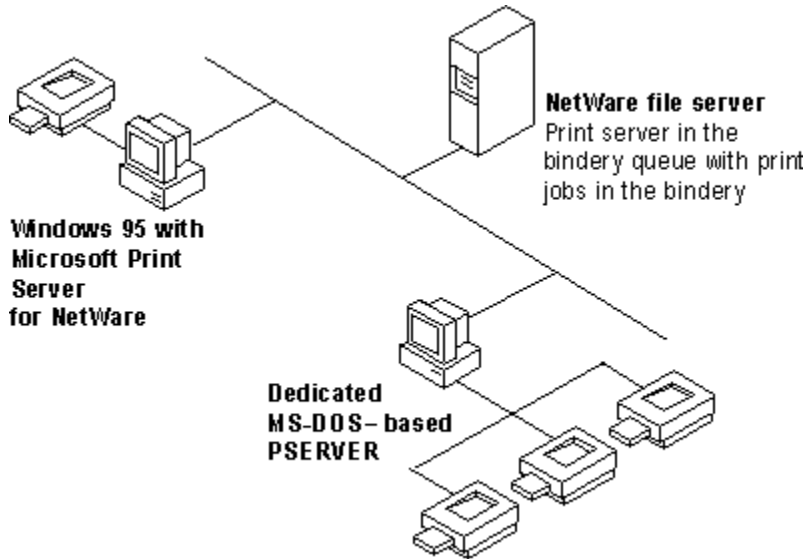

Microsoft Print Services for NetWare uses the queue management services (QMS) API for queue services. It can service one queue for printing to a single printer that is locally attached to a computer running Windows 95.

When you enable the service, it logs on to the NetWare print server, attaches to the print queue, and gets a handle. Then it polls the NetWare print server and receives a header that includes information about how to complete the print job. For example, the header might include information about whether to use a banner, how many copies to print, and other information. Next, Microsoft Print Services for NetWare reads data from the job in the queue and uses Win32 calls to print to the printer. When the job is printed, it returns a call to the NetWare print server.

Microsoft Print Services for NetWare is provided on the Windows 95 compact disc in the ADMIN\NETTOOLS\PRTAGENT directory.



To install Microsoft Print Services for NetWare

1. In the Network option in Control Panel, click Add.
2. In the Select Network Component Type dialog box, click Service, and then click Add.
3. In the Select Network Service dialog box, click Have Disk, and then type the path to the ADMIN\NETTOOLS\PRTAGENT directory.



To enable the Microsoft Print Server for NetWare

1. Before you set up Microsoft Print Server for NetWare, check the NetWare print server and the computer running MS-DOS and is configured as the PSERVER to make sure they are both working correctly.

If you see the following message, you will know that the NetWare print server is not configured

correctly:

Cannot determine print queue name.

2. In the Printers folder on the computer running Windows 95, right-click the printer to which the NetWare print queue will direct jobs, and then click Properties in the context menu.
3. In the print server properties, click Enable Microsoft Print Server For NetWare.

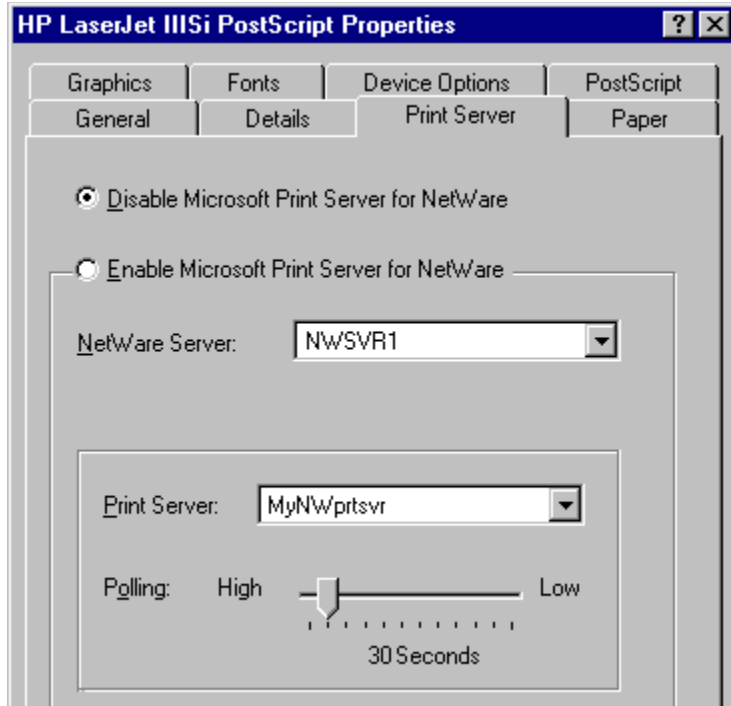

4. From the list of servers, click the NetWare server on which the queue resides.

Note You must have access to this server; only those NetWare servers to which you have access are listed. Access is determined by the user account under which you logged on to the network.

When a NetWare server is selected, the available print server appears in the Print Server list.

5. Adjust the time interval for polling the print queue, and then click OK.

This setting can be adjusted as high as 15 seconds for maximum print server performance, or as low as three minutes for increased local performance. The default is 30 seconds. Click OK.

Note Windows 95 supports only three ports for Microsoft Client for NetWare Networks.

Using DEC PrintServer Software for Windows 95

DEC® PrintServer Software for Windows 95 provides support for printing directly to Digital PrintServer printers from a computer running Windows 95. This software allows extensive bidirectional communication, which allows printers to communicate both job and printer status in real time.

Also, PrintServer Software for Windows 95 lets you choose the best way to print your file. You can select the input and output trays, choose to print either duplex (double-sided) or simplex (single-sided), and print to any PrintServer printer anywhere on the network. PrintServer Software for Windows 95 provides automatic recovery in case of a printer jam so that pages are never lost.



To install PrintServer Software for Windows 95

1. In the Network option in Control Panel, click Add.
2. In the Select Network Component Type dialog box, double-click Service.
3. In the Select Network Service dialog box, click DEC, and in the Network Services list, click DEC Print Server. Click OK.

For more information about this product, see the online Help file for PrintServer Software for Windows 95.

Using the Hewlett-Packard JetAdmin Utility

The HP® JetAdmin utility is an administrative tool used to install and configure Hewlett-Packard® printers connected to a network using an HP JetDirect® print server (network interface). The HP JetAdmin utility operates as a Windows utility and can be used for networking when a Novell NetWare server is available or when the NetWare file (peer-to-peer) server is not available.

From the HP JetAdmin main window, you can:

- Set up a new interface and printer or change an existing configuration.
- Modify printer settings.
- Filter and sort printers that are shown in the list.

From the New or Modify window, you can:

- Configure the HP JetDirect interface and printer.
- Add or remove print queues.
- Select drivers to install and assign Windows 95 drivers to a network printer.
- Select the printer operating mode and set the printer description.



To install the HP JetAdmin Utility

1. In the Network option in Control Panel, click Add.
2. In the Select Network Component Type dialog box, double-click Service.
3. In the Select Network Service dialog box, click Hewlett Packard in the Manufacturer's list, and click HP JetAdmin in the Network Services list. Click OK.

For more information about this product, see the online Help for the HP JetAdmin utility.

Printing and Fonts

Using the Microsoft RPC Print Provider

The Microsoft Remote Procedure Call (RPC) Print Provider enhances network printing and remote administration by providing the full set of Win32 APIs required for a Windows 95 client to administer printer queues on Windows NT servers. Using this print provider, a Windows 95 client can obtain complete accounting and job status information from the Windows NT server. The Microsoft RPC Print Provider is located on the Windows 95 compact disc in the ADMIN\NETTOOLS\RCPPE directory.

Printing and Fonts

Technical Notes on Windows 95 Printing

- Printer driver support
- Extended capabilities port support
- Improved printing support for MS-DOS-based applications
- Support for deferred printing
- Image Color Matching support

Enhanced Metafile Spooling Support

In Windows 95, all output to a non-PostScript™ printer spools as enhanced metafiles (EMFs) instead of as raw printer data as in Windows 3.1. Programs print more quickly (as much as twice as fast as Windows 3.1), so you can resume work sooner.

The following diagram shows how Windows 95 spools EMFs when printing from Windows-based applications. EMFs include instructions about how the document is to be printed. For example, if a document contains a solid black rectangle, the EMF would contain a command to draw a rectangle with the given dimensions, and then fill it in with a solid color, using the color black.

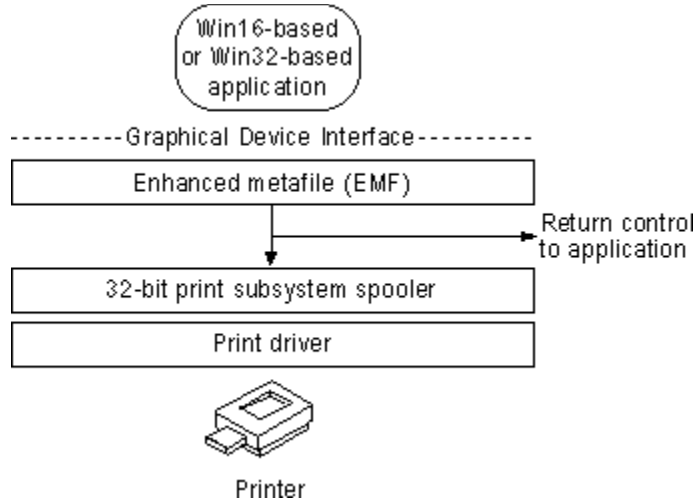

Instead of the raw printer data being generated by the printer driver, EMF information is generated by the Graphical Device Interface (GDI) before spooling. After the EMF is created, control is returned to the user, and the EMF is interpreted in the background on a 32-bit printing subsystem spooler thread and sent to the printer driver. This returns control to the user in significantly less time than waiting for the printer calls to be fully interpreted by the printer driver directly.

Some applications might be able to print only to drivers that generate raw printer data. If this is the case, you should disable EMF spooling.



To disable EMF spooling in the Printers Folder

1. Right-click the printer icon, and then click Properties.
2. Click the Detail tab, and then click Spool Settings.
3. In the Spool Settings dialog box, select RAW in the Spool Data Format list, and then click OK.

Spool Settings [?] [X]

Spool print jobs so program finishes printing faster

- Start printing after last page is spooled
- Start printing after first page is spooled

Print directly to the printer

Spool data format:

- Enable bi-directional support for this printer
- Disable bi-directional support for this printer

OK Cancel Restore Defaults

Bidirectional Communication Support

Through bidirectional parallel communication, Windows 95 detects Plug and Play-compliant printers that return device ID values (as described in the IEEE 1284 specification). This feature allows applications to query the printer directly to find out about its physical attributes.

Bidirectional communication provides the benefit of configuring device driver settings on the server without user intervention. The printer driver can automatically determine how much memory the printer has, what device fonts are available, and so on.

Bidirectional communication also allows printers to send unsolicited messages to Windows 95 and to applications. For example, the printer might send an "out of paper" or "printer offline" message. Bidirectional communication enables much more detailed status reporting on a wider variety of information, such as low toner conditions, paper jams, maintenance needs, and so on.

To use bidirectional printing, you must have the following:

- A bidirectional printer
- An IEEE 1284-compliant cable (a cable that has "1284" printed on it)
- A correctly configured port (some parallel ports are set to AT-compatible mode by default; in this case, you need to set the port to PS/2 mode)

Printer Driver Support

The Windows 95 device driver model includes two parts: a universal driver and a mini-driver. This device driver model makes it easier for printer manufacturers to create drivers for their printers. Windows 95 provides the universal printer driver, which communicates with other parts of the operating system and includes information pertinent to all printers. Printer manufacturers provide mini-drivers to communicate with the universal driver and with the printer itself. The following sections describe the universal driver and the PostScript mini-driver provided in Windows 95.

Note Mini-drivers written for Windows 95 also work with the Windows NT 3.5 universal printer driver.

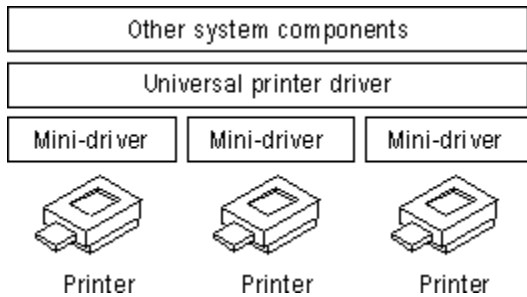

Printing and Fonts

Technical Notes on Windows 95 Printing

Printer Driver Support

Universal Printer Driver

The Windows 95 universal printer driver supports mainstream page description languages, including HP PCL®, Epson® ESC P/2, Canon® CaPSL, Lexmark PPDS, monochrome HP GL/2, and most of the older dot matrix technologies. Almost all non-PostScript printer drivers provided with Windows 95 are based on universal driver technology.

The universal printer driver has full support for device-resident Intellifont and TrueType scalable device fonts. It also supports downloading of TrueType outlines to PCL printers with TrueType rasterizers. Enhancements offer support for downloading unbound TrueType outlines and of character sets with more than 256 characters.

The universal printer driver includes the following:

- Full 600 dots per inch (dpi) support; changes allow future expandability to higher resolutions
- Monochrome HP GL/2 support, providing full LaserJet® 4 functionality
- Generic Text support using TTY.DRV
- Support for ESC P/2 raster graphics directly through the universal driver, rather than through mini-drivers
- Easy-to-use properties dialog boxes for configuring printer driver settings

PostScript Mini-Driver

Microsoft worked closely with Adobe Systems to develop a PostScript mini-driver, which offers the following features:

- PostScript Level 2 support. This feature is automatically enabled for printers reporting as Level 2 from their PostScript Printer Description (.PPD) file.
- Additional support for Image Color Matching (ICM). The PostScript driver allows the server to offload ICM to the PostScript processor to improve performance. This flexibility allows you to take advantage of color raster enhancements on either the printer or the server.
- Control over output data format. The PostScript mini-driver supports CTRL+D handling, Binary Communications Protocol (BCP) and Tagged Binary Communications Protocol (TBCP), and pure binary (8-bit) channels (AppleTalk®).
- Support for version 4.2 .PPD files. These are ASCII files in driver-readable format which contain printer model information that drivers and other software retrieve in order to control a printer. These files cannot be edited. For compatibility, Windows Printer Description (.WPD) files are still supported.
- Support for Simplified Printer Description (.SPD) files. When a printer is installed, Windows 95 reads the .PPD files for each PostScript printer and creates an .SPD file, which is a simplified version of the .PPD file containing only information used by the Windows 95 PostScript mini-driver.

Important Windows 95 does not support editing of .PPD, .SPD, or .INF files. If you need to change these files, contact Adobe Systems.

- Tracking of PostScript virtual memory availability in the printer. This allows you to print more complex documents than you could with Windows 3.1. However, if the printer sends a message saying it can't print because it doesn't have enough virtual memory, you can resolve the problem by changing the PostScript options settings from Optimize For Speed to Optimize For Portability.
- Easy-to-use properties dialog boxes for configuring printer driver settings.
- Support for installable device options, as described in the .PPD file, through the user interface.

Extended Capabilities Port Support

An ECP provides high-speed printing, and support for ECP and ECP devices is included in Windows 95. If you have an ECP, you can connect either ECP or non-ECP devices to the port. In either case, using an ECP will improve I/O performance, although ECP devices will show the greatest I/O gains.

An ECP can be configured in five different ways (defined in the port's Resources properties), as shown in the following list.

Configuration	Description
Basic Configuration 0	Standard I/O ranges for LPT ports only
Basic Configuration 1	Standard I/O ranges for LPT ports and any IRQ
Basic Configuration 2	Standard I/O ranges for LPT ports, IRQ, and any DMA setting
Basic Configuration 3	Any I/O ranges for LPT ports only
Basic Configuration 4	Any I/O ranges for LPT ports and any IRQ setting



To enable ECP support in Windows 95

1. Consult your computer (or add-in card) manual to determine the IRQ and DMA settings selected for each of the ECP ports you want to use. You'll need this information to enable ECP support.
2. In the System option in Control Panel, click the Device Manager tab.
3. Click Ports (COM & LPT), and then select the ECP device. (Notice that you will see this device only if an Extended Capabilities port was detected on your computer. If you have multiple ECP ports, repeat steps 6 through 10 to configure each port's DMA and IRQ values.)
4. Click Properties, and then click the Resources tab. This dialog box shows an I/O range that has been detected automatically.
5. In the Settings Based On field, select Basic Configuration 2. (See the previous table for a description of possible settings for this field.)
6. In the Resource Settings list, click Interrupt Request, and then click Change Settings.
7. In the Edit Interrupt Request dialog box, type the IRQ value you noted in step 1, and then click OK.
8. In the Resources properties, click Direct Memory Access.
9. In the Edit Direct Memory Access dialog box, type the DMA value you noted in step 1, and then click OK.
10. Shut down and restart the computer so the changes can take effect. After restarting, you can take advantage of fast I/O capabilities offered by the ECP.

Improved Printing Support for MS-DOS–Based Applications

With Windows 3.1, users printing from MS-DOS-based applications could not take advantage of the Windows-based spooling functionality offered by Print Manager, and encountered device contention issues when trying to print from MS-DOS-based applications and Windows-based applications at the same time.

Windows 95 addresses the printing limitations of Windows 3.1 by incorporating the functionality for an MS-DOS-based application to spool directly to the 32-bit Windows 95 print spooler. This support is integrated into a print spooler virtual device, which takes the output destined for a printer port and first places it in the Windows 95 print spooler before sending the data to the printer. This functionality works with all existing MS-DOS-based applications, and results in quicker return-to-application time through the use of the spooling mechanism.

Although MS-DOS-based applications do not benefit from EMF spooling (which is supported only for printing from Windows-based applications), users won't encounter device contention issues, and will instead experience smoother background printing and improved printing performance in Windows 95. The print spooling support for use with MS-DOS-based applications is automatically installed and configured, requiring no user intervention.

Deferred Printing Support

The Windows 95 printing subsystem features support for deferred printing. This capability allows users not connected to a printer to generate print jobs, which are stored on their local computers for later printing. This feature is available only if a computer is on a network or is a portable computer that has been removed from its docking station. It is useful when working at a remote site, or when a network printer connection is temporarily lost because of network or printer problems. Deferred printing works with print jobs created in Win16-based, Win32-based, or MS-DOS-based applications.



To prepare for deferred print jobs

1. In Control Panel, double-click the Printers folder, and then click a printer.
2. On the File menu in the Printers dialog box, click Work Offline. The printer will be dimmed in the Printers folder.

Image Color Matching Support

Windows 95 includes Image Color Matching (ICM) support, enabling applications to offer better consistency between the color of images displayed on the screen and the color of images generated by an output device. The technology supporting ICM is licensed from Eastman Kodak.

ICM provides consistent, predictable color rendering from input, through monitor preview, to output. Applications that use ICM functionality enable portability of color information across applications, manipulating the graphic information; across users, providing consistent use of colors; and across platforms, allowing color information to easily be moved to different systems where the ICM technology has been implemented.

The key to ICM support is the use of a profile, which represents the color properties of a monitor, printer, or scanner device. The ICM profile, provided by its vendor as part of the software for the particular monitor, printer, or scanner, resides in the Windows SYSTEM\COLOR directory. The profile used by the ICM support in Windows 95 is the result of an industry consortium called InterColor 3.0, made up of many industry hardware vendors (including Kodak, Microsoft, Apple Computer, Sun Microsystems, and Silicon Graphics, among others) and industry standard-setting bodies. The InterColor group has established a consistent cross-platform color standardization process, including industry-wide standards for defining ICM properties of output and display devices.

Because Windows 95 includes ICM support as part of the operating system, application vendors can integrate ICM functionality into their applications, and thus take advantage of this new system service. To provide support for device-independent color matching, colors used in applications are tied to international (CIE-based) colorimetric standards, rather than in device-dependent form to specific hardware devices. The operating system then performs the appropriate color transformations to map the device-independent color representations to the colors supported by the physical device.

Windows 95 Fonts Overview

Fonts are used to print text, display text on screen, and send text to other output devices. Windows 95 provides a set of Win32-based functions that developers can use to install, select, and query different fonts.

Windows 95 provides three basic kinds of fonts, which are categorized according to how the fonts are rendered for screen or print output:

- TrueType fonts are stored as mathematical models that define the outline of each character. They are much easier to work with than vector fonts because they appear the same on the screen as they do on the printed page. TrueType fonts can be scaled and rotated.
- Raster fonts are stored in files as bitmaps and are rendered as an array of dots for displaying on the screen and printing on paper. Raster fonts cannot be cleanly scaled or rotated.
- Vector fonts are rendered from a mathematical model, in which each character is defined as a set of lines drawn between points. Vector fonts can be scaled to any size or aspect ratio, but are much more limited than TrueType fonts. Windows 95 provides one vector font (MODERN.FON) to ensure backward compatibility with plotter devices. It is installed in the Windows SYSTEM\COLOR subdirectory.

Raster and vector font files have .FON filename extensions. TrueType font files have .TTF filename extensions.

Note In Windows 95, information in the Registry points to a single .TTF file for TrueType fonts as described in [Loading Fonts in Windows 95](#). In addition, Windows 95 includes a hidden file named TTFCACHE that contains FOT type data for TrueType fonts to ensure backward compatibility with Windows 3.1. For TrueType fonts in Windows 3.1, there are two files for each font: the .FOT file contains a relatively short header with pointer information, and the .TTF file contains the actual font data.

TrueType Fonts

TrueType fonts are shapes that are described by their outlines. Instead of being composed of bitmaps (as raster fonts are) or lines (as vector fonts are), TrueType fonts consist of a series of contours.

The TrueType downloadable fonts included with Windows 95 support the Arial®, Courier, Symbol, and Times New Roman® font families. The following table shows TrueType files included with Windows 95.

Font name	Normal	Bold	Bold/Italic	Italic
Arial	ARIAL.TTF	ARIALBD.TTF	ARIALBI.TTF	ARIALI.TTF
Courier New	COUR.TTF	COURBD.TTF	COURBI.TTF	COURI.TTF
Times New Roman	TIMES.TTF	TIMESBD.TTF	TIMESBI.TTF	TIMESI.TTF
Symbol	SYMBOL.TTF	N/A	N/A	N/A
Wingding	WINGDING.TTF	N/A	N/A	N/A

Note The Courier New TrueType Font also ships with the OEM character set to support use of Courier New TrueType fonts in MS-DOS-based applications.

TrueType fonts have many benefits over other kinds of Windows 95 fonts:

- What you see is really what you get, because Windows 95 uses the same font for both screen and printer. You don't have to think about whether you have a specific point size for a particular printer or for your display.
- You can scale and rotate TrueType fonts, and their resolution is clear in all sizes and on all output devices that Windows 95 supports.
- Your document will look the same when printed on different printers. And any printer that uses a Windows 95 universal driver can print TrueType fonts.
- Your document will look the same if you move it across platforms. For example, the text you format in Microsoft Word for Windows 95 will look the same if you open the same document in Word for the Macintosh®.
- Each TrueType typeface requires only a .TTF file to create fonts in all point sizes at all resolutions for all output devices. (Raster fonts need separate files for each point size, resolution, and display device.)
- TrueType fonts are integrated with the operating environment, so all applications created for Windows 95 can use TrueType fonts in the same ways as they do other Windows 95 raster fonts without changes or upgrades.

In many applications, TrueType fonts appear in the Fonts dialog box with a "TT" logo beside the typeface name. Typefaces that are device fonts have a printer icon beside their names in the list.

TrueType fonts are stored as a collection of points and "hints" that define the character outlines. When an application created for Windows 95 requests a font, TrueType uses the outline and the hints to render a bitmap in the size requested. Hints are the algorithms that distort the scaled font outlines to improve how the bitmaps appear at specific resolutions.

After system startup, the first time you select a TrueType font size, TrueType renders a bitmap of the selected characters for display or printing. Because of this, the initial font generation may be slower than with Windows 95 raster fonts. However, Windows 95 stores the rendered bitmaps in a font cache, so each subsequent time the font is used during that Windows 95 session, display or printing will be just as fast as for a Windows 95 raster font.

Windows 95 users can choose any of the following methods for printing TrueType fonts on PCL printers.

Download TrueType as outline soft fonts.

Windows 95 downloads the TrueType font as a scalable outline font. The printer performs all rasterization. This option is available only on PCL printers which can rasterize TrueType fonts; for example, HP LaserJet 4 printers.

Download TrueType as bitmap soft fonts.

Windows 95 downloads the TrueType font as a bitmap soft font. Each set of characters for each font size used is rasterized by Windows 95, then sent to the printer as a separate bitmap font. This is the default method used for PCL printers that cannot rasterize TrueType fonts; for example, HP LaserJet II and III series printers.

Print TrueType as graphics.

Windows 95 rasterizes a whole page of TrueType fonts as a graphic before sending it to the printer. This option is used for PCL printers which cannot accept the format used for downloading TrueType as bitmap soft fonts; for example, the original HP LaserJet and LaserJet Plus printers. This option is also sometimes used for troubleshooting printing problems.

Windows 95 Raster Fonts

Raster fonts are bitmaps supplied in different sizes for specific video display resolutions. The Windows 95 fonts MS Serif, MS Sans Serif, Courier, System, and Terminal are raster fonts.

A raster font file contains data that describes all the characters and style of a typeface for a specific display device. Windows 95 provides several raster font sizes for various display devices. For example, MS Serif comes in point sizes 8, 10, 12, and 14 for CGA, EGA, VGA, and 8514 display devices.

Windows 95 can scale raster fonts to even multiples of the sizes supplied. For example, MS Serif can be scaled to 16, 20, 24, and so on. Bold, italic, underline, and strikethrough styles can also be generated from a standard raster font, but if you try to scale them too far from their original size or style, they appear jagged.

Six resolutions of raster screen fonts are provided with Windows 95. If used for printing, raster fonts print text and graphics as bitmaps or raster lines. The resolutions are identified by a letter appended to the filename of the font, as described in the following table.

Raster Font Files

Letter	Output device	Resolution	x size ¹	y size ¹
B ₂	EGA display	1.33:1	96	72
C ₂	Printer	1:1.2	60	72
D ₂	Printer	1.66:1	120	72
E	VGA display	1:1	96	96
F	8514 display	1:1	120	120

¹ x,y indicates the height/width aspect ratio, in pixels per inch.

² These fonts are not included on the Windows 95 installation disks.

The letter that identifies the resolution is appended to the raster font filenames. For example, the files for the 8514 raster fonts are COURF.FON, SSERIFF.FON, SERIFF.FON, SMALLF.FON, and SYMBOLF.FON, as shown in the following table.

Font	Filename	Character set	Font description
Courier	COURx.FON	ANSI	Fixed-width serif
MS Sans Serif	SSERIFx.FON	ANSI	Proportional-width sans serif
MS Serif	SERIFx.FON	ANSI	Proportional-width serif
Small	SMALLx.FON	ANSI	Proportional small size
Symbol	SYMBOLx.FON	Symbol	Math symbols

Raster fonts can also be printed if their resolution and aspect ratio are close to what your printer requires. If you do not see raster fonts for a printer in an application's Fonts dialog box, check your printer's horizontal and vertical resolution and compare it with the preceding table. If there is a close match, choose the Fonts icon in Control Panel and make sure the appropriate font set is installed. If there is no close match, you cannot print the Windows 95 raster fonts on your printer. You might be able to print raster fonts in a different resolution, if the other resolution has an aspect ratio that matches your printer. Some printer drivers cannot print raster fonts, regardless of the aspect ratio.

You can also purchase from other vendors raster fonts that work with Windows 95 as both screen and printer fonts, such as Adobe Type Manager, Bitstream® FaceLift™, Hewlett-Packard Type Director, and SoftCraft WYSIfonts!®.

Windows 95 Vector Fonts

Vector fonts are a set of lines drawn between points, similar to a pen plotter drawing a set of characters. They can be scaled to virtually any size, but generally they are not as clear as raster fonts in the sizes that raster fonts are specifically designed for.

Windows 95 provides one vector font, MODERN.FON, for compatibility with earlier applications. It is stored in the Windows SYSTEM\COLOR subdirectory. Although MODERN.FON uses the ANSI character set, it is marked internally as an OEM character set.

Vector fonts are stored as a collection of GDI calls that are time-consuming to generate. However, this font is useful for plotters and other devices with which bitmapped characters cannot be used. Before TrueType, vector fonts were also used in some applications to create large characters or characters that are rotated or distorted from the baseline.

Some applications created for Windows 95 automatically use vector fonts at larger sizes. Some applications allow you to specify at what point size you want to use vector fonts. For example, the Vector Above setting in Aldus® PageMaker® specifies the point size at which PageMaker will switch to vector fonts.

Screen and Printer Fonts

Besides the font-rendering mechanism (that is, raster, vector, or TrueType), Windows 95 fonts are described according to the output device:

- Screen fonts are font descriptions that Windows 95 uses to represent characters on the display devices. (TrueType fonts, as listed on the following screen display, act as both screen and device fonts.)
- Printer fonts are the font descriptions used by the printer to create a font.

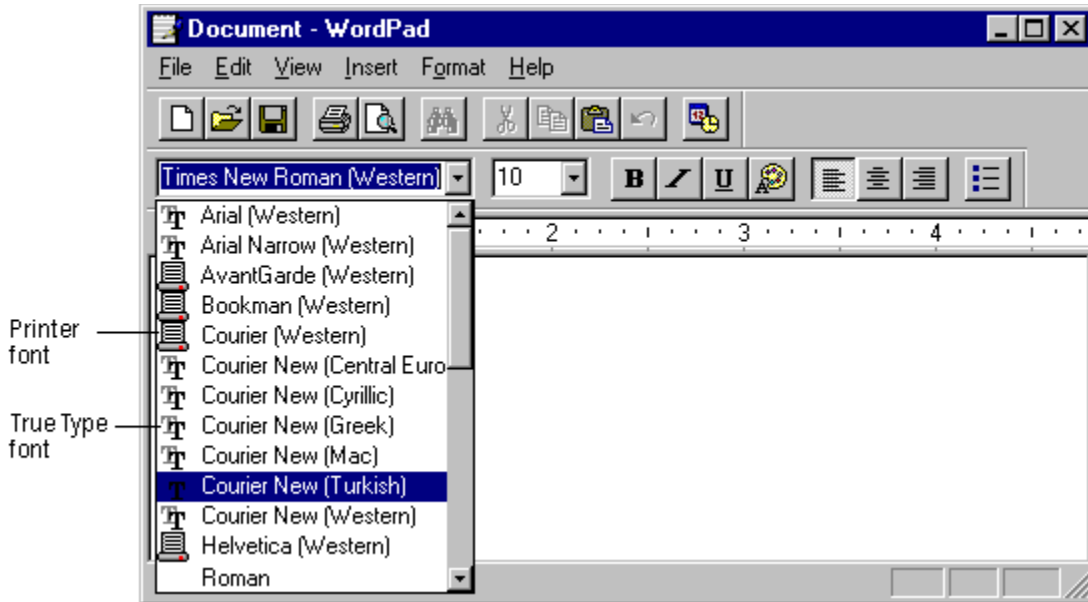

Applications created for Windows 95 can use three kinds of printer fonts:

- Device fonts that reside in the hardware of your printer. They can be built into the printer itself or can be provided by a font cartridge or font card.
- Printable screen fonts are Windows 95 screen fonts that can be translated for output to the printer.
- Downloadable soft fonts that reside on your hard disk and are sent to the printer when needed.

Not all printers can use all three types of printer fonts. Plotters, for example, cannot use downloadable soft fonts.

Fonts Provided for Compatibility

The user interface in Windows 95 relies on TrueType fonts. However, three fonts — System, Fixed, and OEM (or Terminal) — are installed to support display and output devices to support other applications that may require these fonts. Each of these fonts supports two display types — 8514/a (1024x768) resolution and VGA (640x480) resolution.

- System is a proportional font used by default to draw menus, dialog box controls, and other text in Windows 95.
- Fixed is a fixed-width font used in Windows 2.x and earlier versions as the system font (for menus and dialog boxes).
- OEM font (also known as the Terminal font for United States and Europe) is a fixed-width font used, for example, to display the OEM text in the Windows 95 ClipBook Viewer. The OEM font also provides an OEM character set used by some Windows-based applications.

The filenames of the System, Fixed, and OEM fonts provided with Windows 95 are listed in the following table arranged by display type.

Font name	8514/a	VGA
System	8514SYS.FON	VGASYS.FON
Fixed	8514FIX.FON	VGAFIX.FON
OEM	8514OEM.FON	VGAOEM.FON

Windows 95 also provides a set of fonts for displaying MS-DOS-based applications running in a window.

By default, code page 437 (U.S.) fonts are installed. Other font files are included for international language support and are identified by the code page number appended to the filename.

The following font files are provided with the associated code page translation table files.

Code page	Configuration	Font file(s)
437	U.S.	CGA40WOA.FON, CGA80WOA.FON, DOSAPP.FON, EGA40WOA.FON, EGA80WOA.FON
850	U.S.	APP850.FON
850	Multilingual	CGA40850.FON, CGA80850.FON, EGA40850.FON, EGA80850.FON, VGA850.FON
860	Portuguese	VGA860.FON
861	Icelandic	VGA861.FON
863	French Canadian	VGA863.FON
865	Norwegian/Danish	VGA865.FON

Note The TrueType fonts included on the Windows 95 compact disc contain approximately 650 characters that cover all the European languages. For more information about installing multilanguage support in Windows 95, see [International Windows 95](#).

Font Matching Table

When Windows 95 uses the font mapping table to match screen fonts to printer fonts, the characteristics used to find the closest match are, in descending order of importance: the character set, the pitch (variable versus fixed), family, typeface name, height, width, weight, slant, underline, and strikethrough. The Windows 95 search algorithm for finding fonts is the same as the one in Windows

3.1. If the necessary size and bitmap are available, the algorithm proceeds in the following sequence:

1. Use the font found in the printer's ROM.
2. Use the font found in the printer's cartridge slot.
3. Use the downloadable soft font.
4. Use the TrueType font.

Windows 95 also includes PANOSE (panose.bin), a font matching system created by ElseWare, Inc., that is based on a numeric classification of fonts according to visual characteristics. PANOSE classifies fonts by the following:

- Serif
- Proportion
- Contrast
- Stroke Variation and Arm Type
- Letterform
- Midline
- X-height

Applications use PANOSE to substitute the most appropriate available font in publications. The application searches the PANOSE database of the font numbers for the font that most closely matches the requested font.

How Fonts Are Matched in Windows 95

When an application requests characters to print or display, Windows 95 must find the appropriate font to use from among the fonts installed on your computer. Finding the font can be complex. For example, a document might contain fonts that aren't available on the current printer, or there may be more than one font with the same name installed on the computer.

Windows 95 uses the following basic rules for matching a font:

- If the font is a TrueType font, then TrueType renders the character, and the result is sent to the display or to the printer.
- If the font is not a TrueType font, then Windows 95 uses the font mapping table to determine the most appropriate device font to use.

You can also choose from among fonts by comparing similar ones in the Fonts folder.



To manually match fonts

1. In Control Panel, double-click the Fonts folder.
2. In the Fonts folder, click the View menu, and then click List Fonts By Similarity.

In general, if you choose a TrueType font, Windows 95 sorts the list of fonts in descending order with the least similar font listed last.

The following table shows the types of Windows 95 fonts that can be printed on different kinds of printers.

Printer type	Device fonts	Raster fonts	Vector fonts	TrueType fonts
Dot matrix	X	X	–	X
HP PCL	X	-	X	X
PostScript	X	–	X	X
Plotter	X	–	X	–

Loading Fonts in Windows 95

Windows 95 no longer checks the [fonts] section in WIN.INI to load fonts. The locations for all fonts are stored only in the Registry and are automatically moved when an application created for an earlier version of Windows installs a new font in the [fonts] section of WIN.INI.

When Windows 95 starts, it loads both the raster fonts and the TrueType fonts listed in the Registry.

- The raster fonts are resolution-dependent and are listed in the Registry key named Hkey_Current_Config\Display\Fonts. (This supports multiple docking scenarios for portable computers in which there can be a different resolution on the LCD screen from the one on the docking station.) The master list of all possible resolutions for raster fonts is stored in the Registry under the following key:

```
Hkey_Local_Machine\Software\Microsoft\Windows\CurrentVersion\Fontsize
```

- The TrueType fonts are loaded from the location specified in the key:

```
Hkey_Local_Machine\Software\Microsoft\Windows\CurrentVersion\Fonts
```

Printer drivers, which are loaded later in the startup process, look in WIN.INI to load any available soft fonts. These fonts appear within an application's list of available fonts.

Notes Because fonts are stored in the Registry, there is no limit to the number of TrueType fonts that can be installed. In addition, almost 1000 fonts can be used simultaneously, and the same number can be printed in the same document.

In Windows 95, the Enable TrueType Fonts option is no longer available, because the user interface depends heavily upon TrueType. Also, there is no longer a separate Font Installer. You install new fonts by adding them to the Fonts Folder.

Installing Additional Fonts

In Windows 95, fonts can be installed in your computer in several ways:

- Windows 95 automatically installs TrueType and its screen fonts during Setup. When you specify a printer and other options in the Printer Setup dialog box, Windows 95 includes information about font cartridges and built-in fonts for your printer.
- Install more TrueType fonts from disks. After you install TrueType fonts, you do not need to use the Fonts option in Control Panel to install them again.
- Install soft fonts from other vendors on your hard disk by using the utility supplied by the manufacturer. Then use the Fonts option in Control Panel to install the fonts for Windows 95.
- Install a new font cartridge in your printer.

For more information about adding fonts, see online Help.

Note If a TrueType font becomes corrupted, Windows 95 detects this and marks that font as unavailable during the remainder of that Windows session and prevents it from being rendered any longer. You can choose to uninstall the font at that point.



To install cartridge fonts available to Windows-based applications

- Use the installation program that came with the cartridge.
- Or -
1. If you are using an HP LaserJet or DeskJet® PCL printer, right-click the printer's icon, and in the context menu, click Properties.
 2. From the printer's Fonts properties, click the Install Printer Fonts button.
 3. In the HP Font Installer dialog box, select the cartridge fonts you want to install, and then click Exit. Click OK.

If you use the Install Printer Fonts button to install fonts, they appear in the Cartridge list in the printer's Fonts properties. If you use another installation program, the fonts will not appear in this list, but are still available for use with Windows-based applications.



To make installed cartridge fonts available to Windows-based applications

1. Make sure that the font cartridge is inserted properly in the printer.
2. Right-click the printer's icon, and in the context menu, click Properties.
3. From the printer's Fonts properties, select the cartridge fonts you want to use.

Printing and Fonts

Troubleshooting Printing Problems

This section describes how to identify and resolve printing problems.

Windows 95 provides print troubleshooting guidelines in online Help, which you should use first to resolve printing problems. If you cannot resolve the problem by using the print topics in Help, check the procedures in this section.

Correcting Problems with Printer Installation

This section describes conditions that may interfere with installing a printer, and explains how to fix them.

No printers are listed in the Print dialog box.

If you cannot select a specific model because no list appears, verify that the printer INF file exists. The PRTUPD.INF file in the Windows INF directory stores the information displayed in the Manufacturer and Model lists.

Setup is unable to find printer driver files.

If the Add Printer wizard cannot find or access the needed printer driver files, it checks the installation drive and directory. If it cannot locate needed files, a dialog box prompts you to specify the path to the required printer driver files. You can either type the location of the printer driver files (installation source directory) or click Browse to search for the drive and directory location.

File-copy error occurs during printer installation.

If an error occurs with a file copying operation during the installation process, the Add Printer wizard displays the specific error information, including the source and destination paths and filenames it was trying to copy when the error occurred. To continue, verify the location of the specified files, and then retry the installation.

Correcting Specific Printing Problems

This section describes problems or errors that might occur when printing, and explains how to fix them.

You cannot print to a local or network printer.

- Clear the print buffer. Turn the printer's power off, wait about five seconds, then turn the printer on, and try printing again.
- Try printing a test page.
- Verify that there is paper in the printer, that the printer is not jammed, and that there are no problems with the printer cartridge or toner.
- Trying printing to a file.
- If you can print to a file, try copying the file to the printer port (for local printers).



To copy a file to a printer port

- At the MS-DOS prompt, type
`copy /b filename lpt1:`

The switch **/b** directs the system to print a binary file.

If copying the file to the printer port prints the document correctly, the problem is in the communication between Windows 95 and the printer. Check the following (and consult your printer's documentation as needed for further information):

- Check the printer, making sure it is plugged in, turned on, and online.
- Check the printer's self-test program.
- Check the printer connection and printer cable.
- Check the printer configuration.

You cannot print because of a network-specific printing problem.

- Make sure other network resources are available.
- Try connecting over the network to the print server.
- Try removing and adding network protocols.

If you still cannot print, the printer driver might not be working correctly.

You cannot print because of a printer driver.



To check the printer driver in the Printers Folder

1. Right-click the printer's icon, click Properties, and then click Details.
2. In the Details properties, verify that the driver name is correct.
3. Click the Paper tab, and then click the About button. Verify that the driver version is the same as the one listed in the manual from the printer manufacturer.
 - Try printing using another printer driver. For example, use the Generic/Text Only or Generic Laser Printer driver. If this works, check the driver version, and either reinstall or upgrade the driver.
 - Try printing from the MS-DOS command prompt to determine whether the description for the printer driver in the Registry is invalid.



To fix the Registry description for the printer driver

- Remove the current printer driver and reinstall it.

If you still cannot print, an application might be conflicting with the printer driver.

You cannot print because of an application conflict.

- Try printing from a different application.
- If successful, check the failing application's configuration, and reinstall the application if needed.

If you still cannot print, determine whether you have a spooling problem.

You cannot print because of spooler problems.

To determine whether you have a spooling problem, print directly to the port.



To disable all spooling and print directly to the port

1. In the Printers Folder, right-click the printer's icon, click Properties, and then click Details.
2. In the Details properties, click Spool Settings.
3. In the Spool Settings dialog box, click Print Directly To The Printer.

If you can print, there is a spooling problem; do the following to correct it:

- Use **scandisk** to check disk integrity and disk space.
- Disable EMF spooling and enable RAW spooling, as described in [Enhanced Metafile Spooling Support](#), and then retry printing. EMF spooling is enabled by default for all non-PostScript printers.

You cannot print to a printer shared using a server from a network vendor other than Microsoft.

Redirect LPT1 to the shared printer, and then run the Add Printer wizard to set up the printer on LPT1. For example, if a network printer is connected to LPT1, type the following at the MS-DOS prompt:

```
net use lpt1: \\servername\sharename
```

This command depends on the network you are using; consult network documentation to find out how to redirect an LPT port, and then use the Add Printer wizard in Control Panel to set up the printer on the LPT port.

You cannot access remote NetWare servers when making a dial-up connection.

This problem occurs when the computer making the remote connection is also running File and Print Sharing for NetWare Networks. In this case, the File and Printer Sharing service automatically becomes the default server, but it cannot receive the information needed to find the remote servers. To avoid this problem, disable File and Printer Sharing for NetWare Networks before you make the dial-up connection.

You cannot print because of a bidirectional printer problem.



To disable bidirectional printing support in the Printers folder

1. Double-click a printer's icon, click Properties, and then click Details.
2. In the Details properties, click Spool Settings.
3. In the Spool Settings dialog box, click Disable Bi-Directional Support For This Printer.

If you can now print successfully, make sure you have a 1284-compliant printer cable.

Graphic images don't print correctly or output is garbled.

- Start the computer in Safe Mode, and then retry printing.
- Disable Enhanced Metafile spooling.
- Print with a PostScript driver, if supported by the printer. If this prints, then the problem is a UNIDRV.DLL error.
- If PostScript fails, there's either a problem with the GDI or with the application. To verify that it is an application problem try printing another file or try printing from another application.
- Try printing shorter jobs or fewer jobs at a time. If you are printing a long document or several documents, the spooler may be printing one page over another.
- If the graphic is in PostScript (EPS) format, try copying the PostScript file to the printer.
- For a PostScript printer, try changing from vector-graphics to raster-graphics mode. Raster-graphics mode uses less memory.

The printer partially prints pages.

- If the printed page is missing part of a graphic image, this may mean that the printer has insufficient memory. To check for insufficient printer memory, try reducing print resolution.
- Try printing the same graphic image from a different document and application.
- Check the printable region by running a print test from the printer.
- If the printed page is missing a section of text, check the font that is used, and verify that the font is

valid and correctly installed (check the Fonts folder).

- Try printing from a different document with the same font.
- Try printing from the same document with a different font.
- Try enabling Print TrueType As Graphics.
- Try simplifying the page by reducing the number of objects, such as lines, or reduce the number of fonts.

Printing is slower than normal.

- Start the computer in Safe Mode, and then retry printing.
- Verify that EMF spooling is enabled.

You can also try the following:

- Use the Disk Defragmenter utility to check for excessive hard disk fragmentation, and defragment the hard disk drive.
- Check for available disk space for temporary files.
- Check for available system resources.
- Check the printer driver and reinstall it, if necessary.
- Disable the option to send TrueType fonts as bitmaps, as described in the following procedure.



To disable printing TrueType fonts as bitmaps

1. Right-click the printer's icon, and then click Properties.
2. Click Fonts, and then click Send Fonts As.
3. In the Send Fonts As dialog box, click Outlines, and then click OK.

The computer stalls while printing.



To troubleshoot a computer that stalls while printing to a local printer

1. Start the computer in Safe Mode, and then retry printing.
2. Check the printer driver version and reinstall the printer driver if needed.
3. Check the video driver, and reinstall the video driver if needed.
4. Check for adequate free disk space on the TEMP drive.
5. Delete residual spool files, and then retry printing. (See the procedure named "To Clear Residual Spool Files" later in this section.)



To troubleshoot a computer that stalls while printing to a network printer

1. Start the computer in Safe Mode with network support.
2. Try all but the first task in the preceding procedure.

You send a document to the printer, but nothing is printed.

- Check that the system has enough free hard disk space.
- You may need to disable Enhanced Metafile spooling.
- Check that the spooler has cleared the unprinted spool file.



To clear residual spool files

1. Delete spool jobs by deleting .SPL files in the Windows SYSTEM\POOL\PRINTERS directory. For RAW print jobs, .SPL files contain the actual printer data. For EMF print jobs, the .SPL files contain a list of EMFs that reside in the TEMP directory.
2. Check the TEMP directory and delete all .TMP files. All EMFs have filenames similar to EMFxxxxx.TMP.
3. Shut down and restart the computer, and then try printing again. Windows 95 cleans up corrupted .SPL files and their corresponding EMFs when you restart the computer.

Note An error message may appear, although it may be hidden behind other windows, when you print from a Win32-based application in Windows 95. Press ALT+TAB to bring this message box to

the foreground of your desktop.

Troubleshooting Font Errors

This section describes problems with fonts that may occur and explains how to fix them.

Fonts do not print correctly.

To ensure that fonts are installed correctly

1. Double-click the Fonts icon in Control Panel, and make sure the fonts are installed.
2. Double-click the font's icon, and then click Print.

You can also try the following:

- Print using a different font.
- Print a different document using the same font.
- Print with a different application using the same font.
- Print to a different printer using the same font.
- Verify the printer driver version, size, and date.
- Try using a printer-resident font.
- Print to a file, and then copy the file to a port to see if the driver or the spooler is causing the problem. For example:

```
copy filename.prn /b lpt1:
```

- If the printer supports PostScript and PCL, try printing in each format.
- If it is a TrueType font, enable Print TrueType As Graphics.
- Print with a different mini-driver, such as the Generic/TTY.

When printed, fonts appear distorted or unreadable.

- In the application, change to Print Preview mode to see if the fonts appear correct on-screen.
- Change the font size to see if the problem recurs with a larger or smaller font.
- Use a different font to see if the original font is corrupted.
- Check printer resolution. Most non-TrueType fonts are optimized for 300 dpi or greater.
- Cut and paste the formatted text into another application and print it. If the font errors still occur, the problem may be related to the specific font.
- Load a PostScript driver and select Download As TrueType. If the job prints correctly, the problem was with the printer driver or UNIDRV.DLL. Otherwise, the problem is probably in the GDI.
- Check printer memory. If the image is large, you may need more memory.
- For a laser printer, enable the option named Send Font As to print TrueType fonts as bitmaps.

When printed, fonts overlap.

- Try different resolutions, using the same printer. If a higher or lower print resolution works, the printer driver is probably at fault. Try using another printer driver.

Note If the problem persists with more than one printer driver, the problem is likely to be at the GDI level.

- For a laser printer, enable the option named Send Font As to print TrueType fonts as bitmaps, as described earlier.
- Try printing the same information with a different font.

Fonts do not print properly when underlined or strikethrough text is selected.

- Try a different application with the same font.
- Print in a different orientation (that is, if portrait, change to landscape).
- For a laser printer, enable the option named Send Font As to print TrueType fonts as bitmaps, as described earlier.

You cannot convert Type1 fonts to TrueType fonts in the Fonts folder.

Windows 95 does not support this capability. Type1 fonts will work with Windows 95, but you need to

install ATM™ to manage them on the screen and install them for a printer.

Fonts are clipped when printed.

- Recheck the printable region by running a print test from the printer. (Usually, there is a test button on the printer; press this to run a test.) Adjust the paper orientation if you can.
- For a laser printer, enable the option named Send Font As to print TrueType fonts as bitmaps, as described earlier.
- Check the printer memory settings for the driver and printer. If you are printing large images, the printer memory may be insufficient; try printing small images.

Some parts of a TrueType font are rotated, but other parts are not.

- If this occurs because the printer can only print 180-degree and 90-degree rotation (not odd-degree rotations), redefine the degrees of rotation for the image.
- For a laser printer, enable the option named Send Font As to print TrueType fonts as bitmaps, as described earlier.
- If the problem is font-related, try using another character set, or download TrueType fonts to the printer, and then try again.

TrueType fonts do not display in an MS-DOS window.

Sometimes changing the displayed font to a TrueType font in an MS-DOS window does not change the font on the screen. TrueType fonts cannot be displayed in an MS-DOS window if the MS-DOS-based application is running in graphics mode. To work around this problem, run the MS-DOS-based application in text mode and use bitmap fonts in the MS-DOS window.



To change the font used in an MS-DOS window

1. In the MS-DOS window, click the MS-DOS icon in the upper-left corner of the window (or press ALT + SPACEBAR).
2. Click Properties, and then click the Font tab.
3. Under Available types, click Both Font Types.
4. Click the Font size you want to display, and then click OK.

You can distinguish TrueType fonts by the “TT” designation; fonts without this designation are bitmap fonts.

Tip If you print a document to a file, you can copy the print file to print to a printer. At the command prompt, type **copy filename.ext /b prn**

Communications

This part of the *Windows 95 Resource Kit* contains the following chapters which describe the communications capabilities of Windows 95.

Chapter 24 Introduction to Windows 95 Communications

Describes how changes to the communications subsystem in Windows 95 have resulted in improved communications capabilities. It also briefly presents the new communications features that will be explained in other chapters in this section, and provides an overview of mobile computing features in Windows 95.

Chapter 25 Modems and Communications Tools

Describes how to install and use modems with Windows 95, and how to configure HyperTerminal and Phone Dialer, two communications applications that come with Windows 95.

Chapter 26 Electronic Mail and Microsoft Exchange

Describes how to use Microsoft Exchange which provides a central place for sending and receiving messages back and forth among users in a workgroup and among other messaging services such as electronic mail, faxes, and online services. Also describes how Microsoft Exchange lets you move and store documents, messages, and addresses.

Chapter 27 Microsoft Fax

Describes how to use Microsoft Fax software to send and receive faxes and secure mail messages from your computer.

Chapter 28 Dial-Up Networking and Mobile Computing

Describes how to use Dial-Up Networking to remotely access a network. It also describes how other Windows 95 mobile computing tools, such as Briefcase and Direct Cable Connection, allowing mobile users to stay connected to their own computers or to the network.

Chapter 29 The Microsoft Network

Describes how to set up and register to use The Microsoft Network and includes other instructions for providing or restricting access to the service from a network, and briefly describes the features of this new online service from Microsoft.

Chapter 30 Internet Access

Describes how to configure Windows 95 to access the Internet, and also offers some basic tips for browsing and accessing information on the Internet.

Introduction

This chapter describes how changes to the communications subsystem in Windows 95 have resulted in improved communications capabilities over Windows 3.x. It also introduces the new communications features in Windows 95.

- Overview of Communications in Windows 95
- Improved Communications in Windows 95
- Communications Architecture

Overview of Communications in Windows 95

The Windows 95 communications subsystem allows users to make simultaneous connections to a variety of communications services, including electronic mail, fax, and online services. With Windows 95, connecting to another communication service is as easy as connecting to your network.

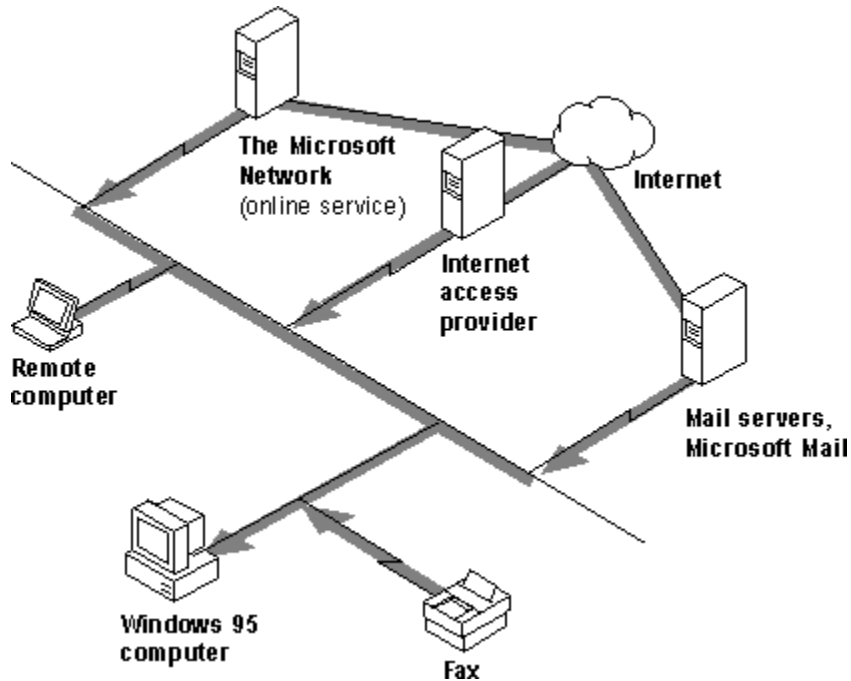

Windows 95 provides the following communications features.

Easy modem installation and operation.

Users need only select and configure a modem once for it to work with all applications created for Windows 95. Users can install a modem in the Modems option in Control Panel, or in an application created for Windows 95 the first time the application is run. Two other communications tools facilitate modem calling: HyperTerminal (an upgrade of Windows 3.1 Terminal) connects two computers over a modem and transfers files between them, and Phone Dialer dials voice telephone calls. For information, see [Modems and Communications Tools](#).

Electronic mail and the Microsoft Exchange client.

Microsoft Exchange is a universal information client that can read and send electronic mail from any message application that supports messaging application programming interface (MAPI) services. These applications include LAN-based mail systems such as Microsoft Mail, or online-based mail systems such as CompuServe® and The Microsoft Network. The Microsoft Exchange client can also send and receive faxes and other remote messages. For information, see [Electronic Mail and Microsoft Exchange](#).

Microsoft Fax.

Microsoft Fax provides a computer running Windows 95 with all the capabilities of a fax machine. With Microsoft Fax and a modem, users can exchange faxes and files as easily as printing a document or sending electronic mail. For information, see [Microsoft Fax](#).

Dial-Up Networking and mobile computing.

Dial-Up Networking provides remote users with complete network capabilities, including downloading and browsing electronic mail, accessing shared files, and running a client-server application. Other mobile computing features include Briefcase, which keeps documents up-to-date on two computers; Direct Cable Connection, which connects two computers for sharing resources; deferred printing capability, which lets users generate print jobs from a remote site and print them when they return to the office; and remote mail using the Microsoft Mail client that comes with Windows 95. For

information, see [Dial-Up Networking and Mobile Computing](#), and [Electronic Mail and Microsoft Exchange](#).

The Microsoft Network.

With a local phone call, this new online service offers affordable and easy access to electronic mail, bulletin boards, chat rooms, file libraries, and Internet news groups. It is the single best place to get information and support for Microsoft products. For information, see [The Microsoft Network](#).

Internet access.

Windows 95 provides all the basic protocols and utilities users need to connect a computer to a server that has access to the Internet, and the software users need to browse and download information from the Internet. For information, see [Internet Access](#).

Improved Communications in Windows 95

The new Windows 95 communications subsystem allows applications to transmit data quickly and reliably and to cooperatively share communications devices. The new kernel and communications architecture in Windows 95 provide the following benefits.

Improvements over Windows 3.1.

Windows 95 replaces the monolithic communications driver architecture of Windows 3.1 with a modular driver model that allows other software and communications device manufacturers to easily plug in new communications device drivers.

High-speed reliability.

Windows 95 supports reliable, high-speed communications. It avoids loss of characters by keeping up with data coming in from the communications port. To quicken communications, the amount of code in the kernel that can be used by only one process at a time (critical sections) has been reduced. In addition, the network architecture and the 32-bit, protected-mode file system of the communications subsystem reduce required mode transitions and interrupt latency. The data-transmission speed in Windows 95 is limited only by the hardware characteristics of the computer, such as the processor speed and the type of communications port. Windows 95 supports communications devices with higher transmission speeds than base RS-232 devices. For example, it supports Integrated Services Digital Network (ISDN), which can communicate at speeds of 64 or 128 kilobits per second, if an ISDN vendor provides a driver.

Higher data throughput.

The 32-bit communications subsystem takes advantage of the preemptive multitasking architecture of Windows 95 to provide better responsiveness to communications applications, thus supporting higher data throughput. Consequently, communications transfers in Win32 applications are not as affected by other tasks running in the system as were Win16-based applications under Windows 3.1.

Support for Plug and Play and legacy communications devices.

Plug and Play support and device installation wizards simplify installation and configuration of Plug and Play and legacy modems and communications devices.

Device sharing among communications applications.

The telephony application programming interface (TAPI) arbitrates among applications that want to share the same communications ports and devices. For example, while Dial-Up Networking waits for an incoming call, Microsoft Fax can send an outgoing fax without the user having to close Dial-Up Networking.

Communications Architecture

Windows 3.1 used a monolithic communications driver, COMM.DRV, that provided an API for Windows-based applications to interact with communications devices and the code that served as the communications port driver. This approach made it necessary to completely replace the Windows communications driver if new functionality was required by a hardware device.

Windows 95 provides a more flexible communications architecture by separating communications operations into three primary areas: Win32 communications APIs and TAPI, the universal modem driver, and communications port drivers.

VCOMM is a new communications device driver that provides the protected-mode services that allow Windows-based applications and drivers to use ports and modems. To conserve system resources, communications drivers are loaded into memory only when in use by applications. Also, VCOMM uses the new Plug and Play services in Windows 95 to assist with configuration and installation of communications devices.

The following figure shows the relationship between the VCOMM communications driver and the port drivers that communicate with hardware devices.

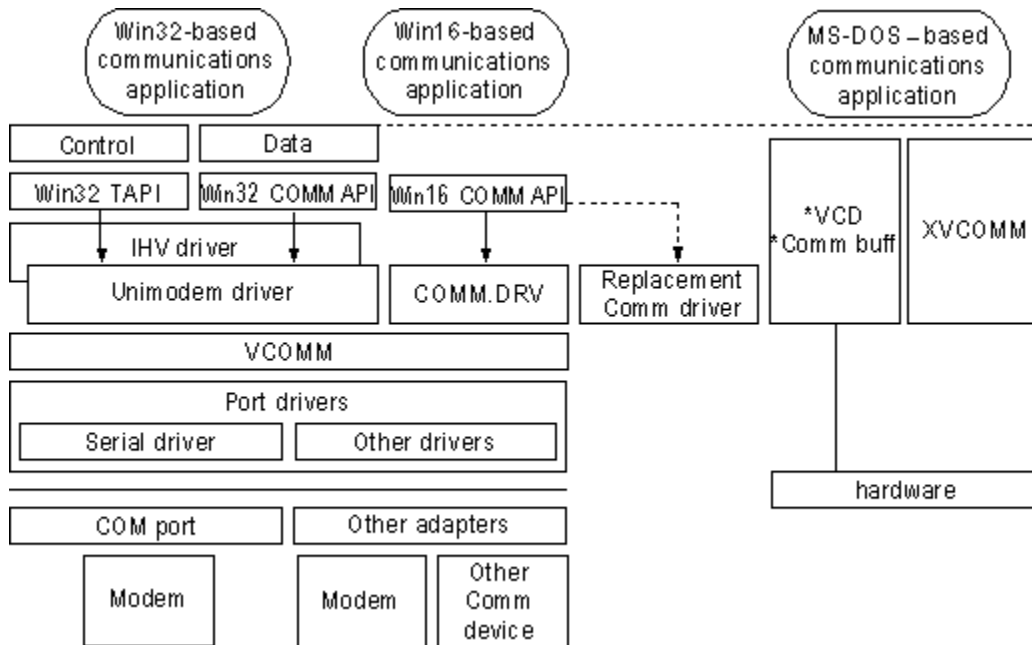

The flow path for a Win16-based application is also illustrated in the previous figure to show how compatibility is maintained when hardware or software vendors replace the Windows 3.1 COMM.DRV driver. The vendor-specific communications driver, however, communicates directly with the I/O port, rather than through VCOMM.

The following list describes the primary areas that make up the architecture.

Win32 communications APIs and TAPI.

The Win32 communications APIs in Windows 95 provide an interface for using modems and communications devices in a device-independent fashion. Applications call the Win32 communications APIs to configure modems and perform data I/O through them. Through TAPI, applications can control modems or other telephony devices.

Universal modem driver.

The universal modem driver (Unimodem) is a layer that provides services for data and fax modems and voice so that users and application developers will not have to learn or maintain difficult modem AT commands to dial, answer, and configure modems. Rather, Unimodem does these tasks automatically by using mini-drivers written by modem hardware vendors.

Unimodem is both a VCOMM device driver and a TAPI service provider. Other service providers (for example, those supporting other devices, such as an ISDN adapter, a telephone on a PBX system, or an AT-command modem) can also be used with TAPI.

Port drivers.

Port drivers are specifically responsible for communicating with I/O ports, which are accessed through the VCOMM driver. Port drivers provide a layered approach to device communications. For example, Windows 95 provides a port driver to communicate with serial communications and parallel ports, and other vendors can provide port drivers to communicate with their own hardware adapters, such as multiport communications adapters. With the port driver model in Windows 95, it is not necessary for vendors to replace the communications subsystem as they did in Windows 3.1.

Windows telephony API.

TAPI-aware communications applications no longer need to provide their own modem support list because interaction with a modem is now centralized by Windows 95. All communications services provided with Windows 95 use these services.

TAPI provides a standard way for communications applications to control telephony functions for data, fax, and voice calls. TAPI manages all signaling between a computer and a telephone network, including basic functions such as dialing, answering, and hanging up a call. It also includes supplementary functions, such as hold, transfer, conference, and call park found in PBX, ISDN, and other phone systems. TAPI also provides access to features specific to certain service providers, with built-in extensibility to accommodate future telephony features and networks as they become available.

TAPI services arbitrate requests from communications applications to share communications ports and devices in a cooperative manner. Win32-based applications can use TAPI functionality to make outgoing calls while others are waiting for incoming calls. Of course, only one call can be performed at a time, but users no longer have to close applications that are using the same communications port.

TAPI consists of two interfaces: an API that developers use to write applications and the service provider interface (SPI) that applications use to establish the connection to the specific telephone network. This model resembles the computer industry model for printers in that printer manufacturers provide printer drivers for Windows-based applications. The following figure shows the relationship between the front-end TAPI and the back-end SPI.

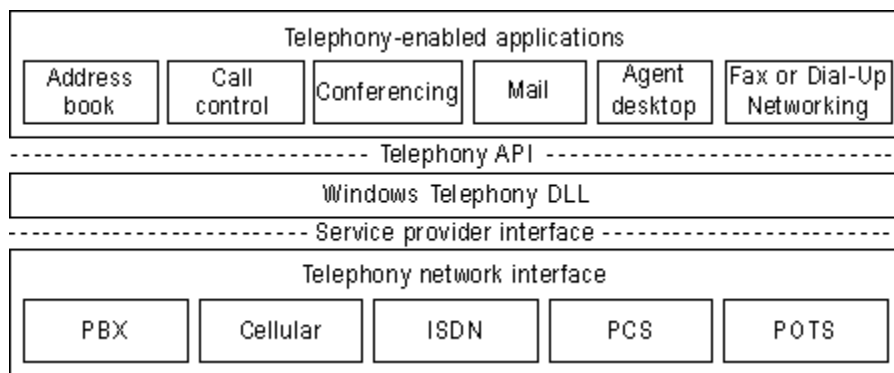

Introduction

This chapter describes how to install and use modems with Windows 95, and the other communications tools in Windows 95, including HyperTerminal, Phone Dialer, and Microsoft File Transfer.

- Modems and Communications Tools: The Basics
- Modems and Communications Tools: The Issues
- Setting Up a Modem
 - Defining Your Location
 - Setting Modem Properties
 - Dialing Manually
- Displaying the Terminal Window
- Modem Registry Keys
 - Init Key
 - Responses Key
 - Settings Key
- Using HyperTerminal
 - File Transfer Protocols
 - Terminal Emulation Types
- Using Phone Dialer
- Using Dialing Properties
 - Defining Calling Locations
 - Defining Calling Card Rules
- Using Microsoft File Transfer
- Telephony Drivers from Other Vendors
- Troubleshooting Communications Problems
 - Correcting Problems with Modem Installation
 - Correcting Connection Problems
 - Correcting Modem Access Problems with Applications

Modems and Communications Tools: The Basics

Windows 95 simplifies using modems by allowing you to install and configure a modem once to work for all communications applications, just as you do for a printer. This provides the following benefits:

- Centralized modem and COM port configuration through the Modems option in Control Panel for all communications applications created for Windows 95
- Support for hundreds of brand-name modems, including automatically detecting them
- Modem connections and configuration using point-and-click instead of AT commands

Note For applications created for Windows 3.1 or MS-DOS, you still need to define the serial port, modem type, and other modem settings within each application.

Windows 95 includes three tools for expanding communications capabilities:

- HyperTerminal allows you to connect two computers through a modem and telephony application programming interface (TAPI) for transferring files, and it also automatically detects data bits, stop bits, and parity.
- Phone Dialer allows you to use a computer to dial phone numbers for voice telephone calls. It includes a telephone dial pad, user-programmable speed dials, and a call log.
- Microsoft File Transfer allows you to send and receive files while talking on the phone.

With Windows 95, you can do the following:

- Set up a modem in the Modems option in Control Panel, or in a communications application created for Windows 95 (such as HyperTerminal) when you run it for the first time. Windows 95 provides an Install New Modem wizard that automatically detects the modem type and sets its default settings.
- Send and receive faxes over a modem using Microsoft Fax. For more information, see [Microsoft Fax](#).
- Configure HyperTerminal to predefine computers to which your computer can connect.
- Configure Phone Dialer to make voice telephone calls.
- Define the location you are calling from just once in Dialing Properties. All communications tools and applications created for Windows 95 reference that location when dialing out.
- Manually dial a phone call or display a terminal window before or after dialing. For information, see [Setting Modem Properties](#).
- Connect to a remote computer by using Dial-Up Networking. For information, see [Dial-Up Networking and Mobile Computing](#).

Modems and Communications Tools: The Issues

Before you install and configure a modem for use with Windows 95, you should decide the following:

- How many users need modems installed on their computers and what are the locations to which and from which they will be calling.
- What kind of security restrictions you want to apply to modems installed on individual computers, as described in [Security](#).
- What properties you need to set for making connections, as described in [Setting Modem Properties](#).

Note In Windows 95, you cannot share a modem installed on another computer on the network. You can, however, share a fax modem over the network. For information, see [Microsoft Fax](#).

Setting Up a Modem

You can install a new modem in one of three ways:

- Using the Modems option in Control Panel
- Running a communications application, which causes Windows 95 to prompt you to install a modem
- Adding a modem through the Add New Hardware option in Control Panel

In all cases, the Install New Modem wizard appears, and asks if you want Windows 95 to automatically detect the modem or if you want to manually select a modem from the list of known manufacturers and modem models. If you choose the detection option, the wizard detects and then queries the modem to configure it. If it cannot detect the modem, it prompts you to select one.

When the modem has been selected, you can, if necessary, adjust its properties, such as the volume for the modem speaker, the time to wait for the remote computer to answer the call, and the maximum speed to use.

Depending on the type of modem you have, installing and configuring it might vary slightly as follows:

- If you install an internal legacy (non-Plug and Play) modem adapter, its built-in COM port must be configured by using the Add New Hardware wizard before it is installed by using the Modems option in Control Panel. In most cases, the Install New Modem wizard does this automatically for you. However, on some computers, you might also need to run the Add New Hardware wizard.
- If you are using Windows 95 PCMCIA drivers, then Windows 95 will detect and configure PCMCIA modem cards automatically when they are first inserted. Otherwise, you might need to run the Add New Hardware wizard in Control Panel to configure the card's built-in COM port. Then, you should install the PCMCIA modem card by using the Modems option in Control Panel. For more information, see [Devices](#).

Note Before you install a modem, check the Modems section in the Windows 95 README.TXT for possible information.



To install a modem by using the Modems option in Control Panel

1. In Control Panel, double-click the Modems icon.
2. If no modem is currently installed on your computer, the Install New Modem wizard starts automatically to lead you through the steps for installing a modem. Follow the online instructions.
– Or –
If you are installing a second modem, click Add to start the Install New Modem wizard.

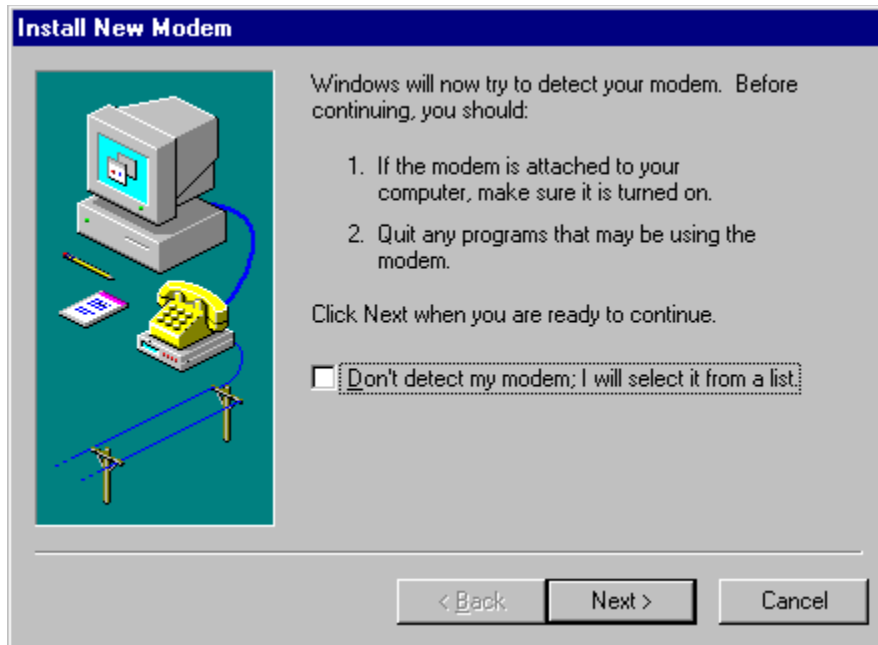

In most cases, it's best to let the Install New Modem wizard detect the modem for you. If it cannot detect the exact manufacturer and model, the wizard picks a standard configuration that is usually compatible. Your modem will still function at its maximum speed and according to factory default settings. A few advanced features might be disabled, such as enabling and disabling compression, error control, and flow control.

For information about installing a modem if your modem is not detected or listed, or about finding a better match than the standard modem, see [Troubleshooting Communications Problems](#).

Windows 95 automatically assigns COM names to communications ports, internal modem adapters, and PCMCIA modem cards according to their base I/O port addresses as described in [Devices](#).

Defining Your Location

The first time you set up a modem, the Install New Modem wizard prompts you for information about the location you will usually be calling from (the Default Location), including your area code and country code. This information is stored in Dialing Properties, a communications utility that is accessible from all communications applications created for Windows 95 and in the Modems option in Control Panel.



To set dialing location information

- Run the Install New Modem wizard, and then type the area code and country code information in the Location Information dialog box.

Please provide information about your current location so that your calls can be dialed correctly.

What country are you in now?
United States of America (1)

What area (or city) code are you in now?
206

If you dial a number to access an outside line, what is it?
9

The phone system at this location uses:
 Tone dialing Pulse dialing

< Back Next > Cancel

After you install the modem, more specific location information, such as calling card numbers or the number you must dial to access an outside line, can be entered into the My Locations dialog box in Dialing Properties. For information, see [Using Dialing Properties](#).

Setting Modem Properties

In the Modems option in Control Panel, you can globally change default modem settings for all communications applications and tools created for Windows 95. For example, if you do not want to listen to the modem speaker, you can turn it off for all tools and applications that use that modem. Alternatively, you can adjust these settings within each application.

Note For Windows 3.1-based or MS-DOS-based applications, you need to configure the modem settings within each application.



To view general properties for a modem

1. In the Modems option in Control Panel, click a modem, and then click the Properties button.
2. In General properties, view the default settings for the modem that will be used by all applications created for Windows 95.

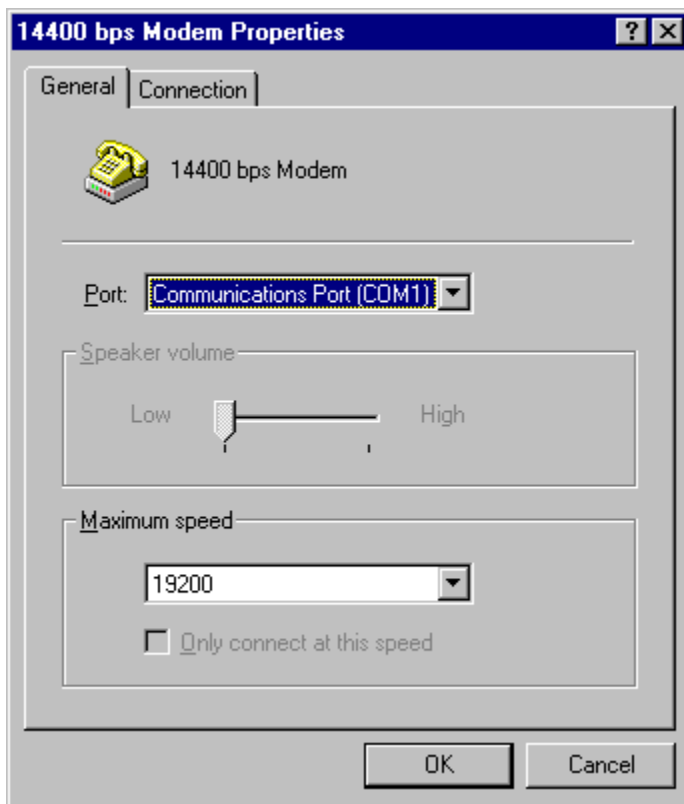

Option	Description
Port	A port is either a COM or LPT port to which an external modem is attached, or a COM port name which identifies an internal or PCMCIA modem. Windows 95 automatically assigns a port name (COM1, COM2, COM3, or COM4) to any device it detects. Usually, the name is adjusted only if you move an external modem from one COM port to another. For PCMCIA modem cards, the port cannot be changed.
Speaker volume	Sets the volume for the telephone speaker, which broadcasts the dial tone, modem connection, and

voices, if applicable, on the other end. To change the volume, move the slider bar to the right or left.

Maximum speed This is the speed at which Windows 95 communicates with the modem. It is limited by the CPU speed of the computer and the speed supported by the communications port. Windows 95 selects a conservative default speed so that slower computers do not lose data during transfers.

Set the speed lower if the faster rate causes data errors. Set it higher for faster performance if you are using a computer with an 80486 or a Pentium™ processor. For example, 57600 might work better than the Windows 95 default setting of 38400 for v.32bis (14400 bps) modems on fast computers. If applications report data errors, then set a lower speed (for example, change it from 38400 to 19200 for v.32bis modems).

Tip If you have a slower, older computer and an external modem, you can purchase and install a 16550A UART-based COM port adapter to increase speeds. Some internal modems have an integrated 16550A UART adapter.



To change or view the connection properties

- In General properties, click the Connection tab to display the connection options for your modem.

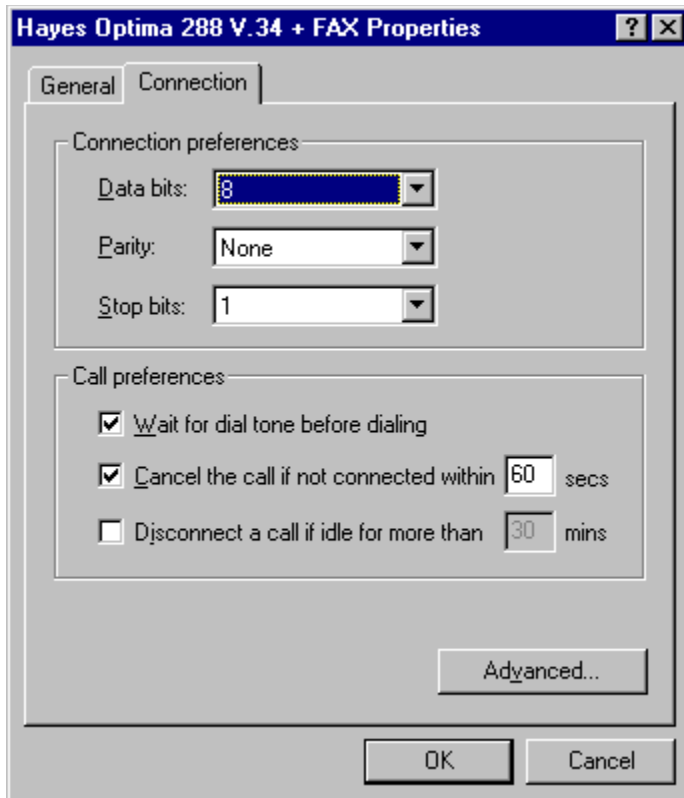

Option

Connection preferences

Description

Connection settings usually correspond to what the computer on the other end is using. Therefore, do not

change connection settings by using the Modems option in Control Panel. Rather, use a specific tool or application, such as HyperTerminal, to change these settings on a connection-by-connection basis.

- Wait for dial... Clear this option if you are making calls from a country other than where your modem was purchased and your modem fails to properly detect the dial tone.
- Cancel the call... Change the number of seconds listed in this field if, for some reason, it takes a long time to make a connection; for example, this might occur when you are making an international call and there are long delays before the call is connected.
- Disconnect a call... Change the number of minutes listed in this option if, for some reason, there is no activity on the line; for example, increase the number if you want to stay connected to a computer bulletin board even though there is no activity.

You can also specify settings for data bits, parity, and stop bits in the Connection properties. For information about these values, see online Help.



To view or change advanced connection properties

- Click the Advanced button in the Connection properties to display the Advanced Connection Settings dialog box. In this box you can set error control, flow control, and modulation, and audit the modem operations.

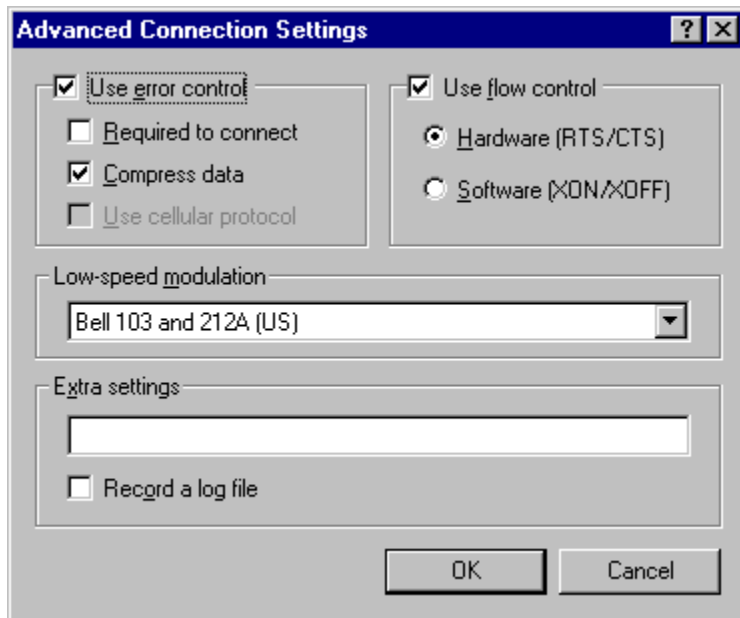

Option	Description
Use error control	Check this option to boost file transfer speeds by eliminating errors caused by noise on the telephone line. This feature is available on most newer modems. When this feature is enabled, modems sometimes have trouble connecting. If this occurs, clear the check box and try again.
Required to	Check this option if you want your modem to connect

connect	with another modem only if error control is enabled on a call. This is useful in areas with very noisy phone lines. In these cases, connecting at a slower speed can improve data throughput.
Compress data	Check this option to boost transmission speeds by compressing data between the modems. This feature is available on most modems. When this feature is enabled, modems sometimes have trouble connecting. If this occurs, clear the check box and try again. Using modem compression can sometimes reduce performance if the data being sent is already compressed by the application.
Use cellular protocol	Check this option when you want your modem to use special protocols designed to reduce errors over cellular connections. You might want to clear this when making a call on a normal noncellular telephone line.
Use flow control	Check this option for all external modems to avoid loss of data. If your modem cable has RTS and CTS wires connected, you can use hardware flow control; otherwise, use software flow control.
Low-speed modulation	Check this option if you are having problems making an international call. Depending on the type of modem, Windows 95 provides three possible settings: Bell 103 and 212A, A (for calls in the United States), ITU-TV V.21 and V.22 (for international calls), and ITU-TV V.23 (for French Minitel calls).
Extra settings	Check this field to type modem commands that Windows 95 will include in the initialization sequence that it sends to the modem before dialing. Do not include the "AT" prefix in this box. The Extra Settings option is intended only for debugging purposes, and should be used only by experienced modem users.
Record a log file	Check this option to record commands and responses to and from the modem in the MODEMLOG.TXT file in the Windows directory. Reading this file along with a modem manual can help you solve problems. After you identify the problem, you can adjust the appropriate modem keys in the Registry. Only advanced users should use this feature.

Modems and Communications Tools

Setting Up a Modem

Dialing Manually

Windows 95 allows you to manually dial your modem if you are having difficulty making an international call or other connection. To manually dial your modem, you need a separate telephone headset and keypad. You can request manual dialing, using slightly different procedures from within any Windows 95-based communications applications, such as HyperTerminal, Dial-Up Networking, or Microsoft Fax. The following procedure describes how to manually dial your modem by using Dial-Up Networking.



To manually control modem dialing

1. In Dial-Up Networking, right-click a connection icon, and then click Properties.
2. Click the Configure button, and then click the Options tab.

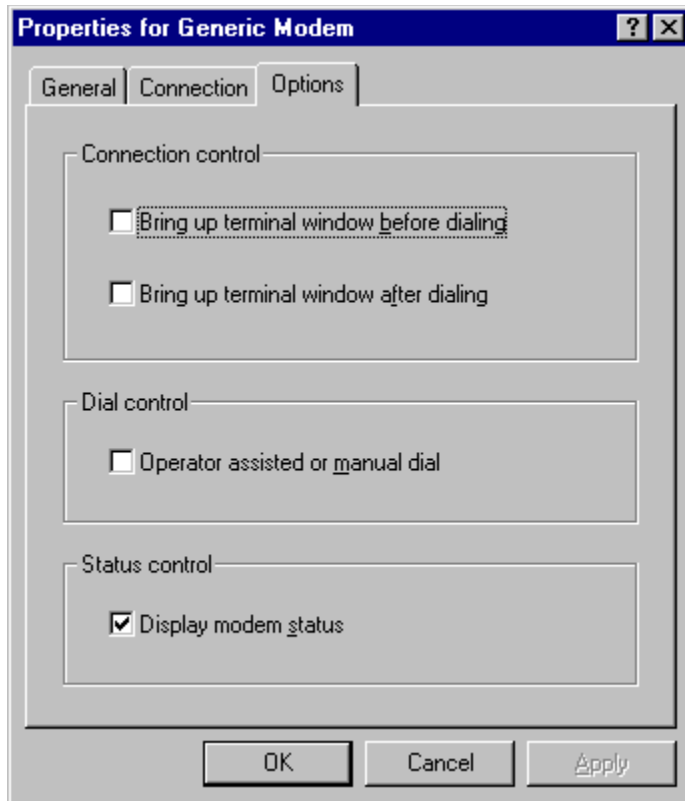

3. Click the Operator Assisted or Manual Dial option, and then click OK.
4. Double-click the connection icon in Dial-Up Networking, and then click Connect.
5. When instructed, pick up the phone and dial the number.
6. When you hear the other computer answer, click Connect and hang up.

Displaying the Terminal Window

Before or after dialing, you can display a terminal window to type AT modem commands if a connection requires them. A terminal window can be used to log on for security purposes, to establish connections with servers that require a specific logon procedure, and for other reasons. The following procedure describes this process for Dial-Up Networking.



To display a terminal window before or after dialing

1. In Dial-Up Networking, right-click a connection icon, and then click Properties.
2. Click the Configure button, and then click the Options tab.
3. Click the Bring Up Terminal Window Before Dialing option, or the Bring Up Terminal Window After Dialing option, and then click OK.

Modem Registry Keys

The following section describes information stored in specific modem Registry keys that might help advanced users correct problems with the commands that Windows 95 uses to control a modem. To identify modem problems, you can enable Windows 95 to create a MODEMLOG.TXT file (as described in [Setting Modem Properties](#)), which contains responses to and from a modem when a connection was made. The MODEMLOG.TXT file might indicate when Windows 95 is sending an incorrect command string to a modem, or when a response code is not being correctly interpreted. After consulting the documentation for the modem, you might be able to adjust the modem's Registry keys to restore proper operation.

Modem Registry keys are stored under the following key:

```
Hkey_Local_Machine\System\CurrentControlSet\Services\Class\Modem
```

For each installed modem, Windows 95 creates one Registry key (starting with \0000); additional subkeys, which contain AT commands that Windows 95 uses to initialize, dial, and answer the modem; plus other entries that communications and modem drivers use.

Some of the more important entries that you can use to correct or optimize modem operation are described in the following sections. The full set of modem Registry keys and the INF file format are documented in the *Windows 95 Device Development Kit*.

Modems and Communications Tools

Modem Registry Keys

Init Key

The multiple, modem-command string entries in the Init key initialize the modem before Windows 95 uses it. The name of each entry is its sequence number, starting with the number **1**, and its data is the command that is sent to the modem. Usually, the Init key entry **1** is **AT<cr>**, which is sent to the modem to start it. Init entry **2** usually contains **&F** or a similar command to restore the modem to its default settings. Subsequent Init key entries contain miscellaneous commands to configure the modem so it is compatible with Windows 95.

Responses Key

The Responses key contains strings that the modem might report to Windows 95 in response to a command or during the connection process. The name of each subkey is the text of a single modem response, and its data is a 10-byte binary value specifying the meaning of the response to Windows in a coded format. The first two characters (byte 0) specify the meaning of the response code, using one of the following values.

Value	Type	Description
00	OK	The modem accepted the previous command.
01	Negotiation Progress	Status information about a new connection is being reported.
02	Connect	A call is connected; the modem is in data mode.
03	Error	The modem rejected the previous command.
04	No Carrier	The call was disconnected.
05	No Dial Tone	No dial tone is present.
06	Busy	The dialed modem is busy.
07	No Answer	The dialed modem did not answer.
08	Ring	There is an incoming call.

The second two characters (byte 1) specify information about a connection that is being made. It is used only for response codes of type Negotiation Progress or Connect, and is one of the following values.

Value	Error control negotiated	Compression negotiated	Cellular protocol negotiated
00	-	-	-
01	-	X	-
02	X	-	-
03	X	X	-
08	-	-	X
09	-	X	X
0A	X	-	X
0B	X	X	X

The next eight characters (bytes 2-5) specify the modem-to-modem line speed negotiated in bits per second (bps). The characters represent a 32-bit integer, doubleword format (byte and word reversed). Common examples for this value include the following.

Bits per second	String
2400	60 09 00 00
9600	80 25 00 00
14400	40 38 00 00
19200	00 4b 00 00
28800	80 70 00 00

The last eight characters (bytes 6-9) indicate that the modem is changing to a different port or Data Terminal Equipment (DTE) speed. Usually, this field is not used, because modems make connections at a "locked" port speed, regardless of the modem-to-modem or Data Communications Equipment (DCE) speed. However, for modems that support only "direct" modes, you can lower the DTE speed by specifying a negotiated DTE speed for a response code, using the same format as the DCE speed described in the preceding table.

Settings Key

The Settings key contains commands for configuring various modem settings. After the Init key commands are sent, Windows 95 builds a dynamic configuration command string by concatenating various entries shown in the following table. The command string depends on the settings selected in the modem's properties.

Subkey	Description	Example
Prefix	Configuration command prefix	AT
Terminator	Configuration command suffix	<cr>
DialPrefix	Dial command prefix	D
Dial_Pulse	Use pulse dialing	P
Dial_Tone	Use tone dialing	T
Blind_Off	Detect dial tone before dialing	X4
Blind_On	Do not detect dial tone before dialing	X3
CallSetupFailTimeo ut	Specify call setup time-out	S7=<#>
InactivityTimeout	Specify inactivity time-out	S30=<#>
SpeakerVolume_Lo w	Low speaker volume	L1
SpeakerVolume_Me d	Medium speaker volume	L2
SpeakerVolume_Hig h	High speaker volume	L3
SpeakerMode_Off	Speaker always off	M0
SpeakerMode_Dial	Speaker on during dial and negotiation	M1
SpeakerMode_On	Speaker always on	M2
SpeakerMode_Setu p	Speaker on only during negotiation	M3
FlowControl_Off	No flow control	&K0
FlowControl_Hard	Hardware flow control	&K1
FlowControl_Soft	Software flow control	&K2
ErrorControl_Off	Error control disabled (normal mode, not direct)	+Q6S36=3S48=128
ErrorControl_On	Error control enabled (auto reliable)	+Q5S36=7S48=7
ErrorControl_Forced	Error control required to connect (reliable)	+Q5S36=4S48=7
ErrorControl_Cellula r	Cellular protocol enabled	\N3-K1)M1-Q1*H1
Compression_On	Compression enabled	S46=138
Compression_Off	Compression disabled	S46=136
Modulation_CCITT	Use CCITT modulations for 300 and 1200 bps	B0
Modulation_Bell	Use Bell modulations for 300 and	B1

	1200 bps	
SpeedNegotiation_ Off	Connect only at default modem speed; do not fall back	N0
SpeedNegotiation_ On	Use lower DCE speed to connect, if necessary	N1

Modems and Communications Tools

Using HyperTerminal

You can use HyperTerminal with a modem to connect two computers so you can send and receive files or connect to computer bulletin boards and other information programs. For example, you can use HyperTerminal to connect to an online service and to download files from a bulletin board on the online service. You can also use HyperTerminal to connect a computer directly to another computer, such as a debugging terminal.

The easiest way to install HyperTerminal is to choose Custom setup type during Windows 95 installation and then select HyperTerminal when selecting components to install.



To install HyperTerminal after Windows 95 Setup

1. In the Add/Remove Programs option in Control Panel, click the Windows Setup tab.
2. In the Windows Setup Components list box, click Communications, and then click the Details button.
3. In the Communications dialog box, click HyperTerminal, and then click OK.

For more information, see the online Help in HyperTerminal.

File Transfer Protocols

HyperTerminal supports the following file transfer protocols.

Protocol	Description
Xmodem	The most common error-correcting data communications protocol. Most communications packages support (and some only support) Xmodem. This protocol is also supported by most online services. Xmodem is slower than other protocols (for example, Zmodem).
1K Xmodem	A variant of traditional Xmodem, which sends data in 1K (1024-byte) blocks instead of 128-byte blocks. On some bulletin boards, this protocol is called Ymodem.
Ymodem	A faster version of Xmodem, transferring data in 1K blocks.
Ymodem-G	A variant of Ymodem designed for use with modems that support hardware error control. If you cannot transfer files by using Ymodem-G, your modem might not support error control. Use Ymodem instead.
Zmodem	The fastest data transfer protocol, and the primary choice of most bulletin board users. Zmodem dynamically changes its block size based on line conditions, and it is extremely reliable.
Kermit	An extremely flexible protocol, found most often on DEC™ VAX™ computers, IBM® mainframes, and other minicomputers. However, Kermit is quite slow and should not be used if faster options are available on the other computer.

Note You can choose a file transfer protocol to use when you send or receive a file by using the Send or Receive File options in the Transfer menu, as described in online Help.

Terminal Emulation Types

HyperTerminal supports the following terminal emulation types.

ANSI	Viewdata (for the United Kingdom)
Minitel (for France)	DEC VT 100™
Auto Detect	VT 52
TTY	



To choose a terminal emulation type

1. Right-click a connection icon, and then click Properties.
2. In the connection's properties, click the Settings tab, and then select the emulation type.

Note Some modems might not be able to connect to French Minitel in HyperTerminal using the Windows 95 default settings. To correct this, you need to add an extra command in the Extra Settings field in the Advanced Settings dialog box in the modem's properties. Check the modem manual for the command that enables the modem to connect in V.23 modulation to Minitel, and then add this to the Extra Settings field.

Using Phone Dialer

The Phone Dialer application that comes with Windows 95 allows you to use a computer to make voice telephone calls using the calling card and location information defined in Dialing Properties. It also stores frequently dialed numbers, dials stored phone numbers, and logs telephone calls.

The easiest way to install Phone Dialer is to choose Custom Setup during Windows 95 installation and then follow the following procedure. You can also install it after Windows 95 installation in the Add/Remove Programs option in Control Panel.



To install Phone Dialer after Window 95 installation

1. In the Add/Remove Programs option in Control Panel, click the Windows Setup tab.
2. In the Windows Setup Components list box, click Communications, and then click the Details button.
3. In the Communications dialog box, click Phone Dialer, and then click OK.



To start Phone Dialer and make a call

1. From the Start button, point to Programs, then point to Accessories, and then click Phone Dialer.
2. In the Phone Dialer dialog box, type a phone number either from your keyboard or use the Phone Dialer numeric keypad. Click Dial.



When you dial a number with Phone Dialer, the number is automatically stored in a list of your most recently used telephone numbers. All local, domestic long-distance, or international telephone numbers are stored when you type all the digits needed to dial in the Number To Dial text box. You can also store phone numbers as speed-dial numbers.

Important The Number To Dial text box can hold as many as 40 digits. Therefore, you can type a local, domestic long-distance, or international long-distance phone number in this text box. The same is true when you create speed-dial numbers.

If you type the area code and local telephone number, Phone Dialer automatically precedes the dialed number with a "1" if you have typed this information in the My Locations properties in the Dialing Properties dialog box. Dialing Properties is a separate communications tool described in [Using Dialing Properties](#).

If you type nonnumeric characters (such as a hyphen or a parenthesis) in a phone number, Phone

Dialer ignores them except when you type a plus sign (+) at the beginning of your number, which is international format. If you type a number in international format, you must put parentheses around the area code, for example, +1 (206) 882-8080.

For more information, see the online Help in Phone Dialer.

According to the North America Dialing Plan (a standard set of procedures that telephone companies in North America use), you must dial a "1," followed by a three-digit area code, followed by a seven-digit local phone number to make a long-distance call. There are a few cases where local phone companies have not followed this rule by allowing you to omit the initial "1" for certain numbers in adjacent area codes. Thus, the number you dial is 10 digits, not 11.



To dial long-distance calls without a "1" prefix

1. From the Tools menu in Phone Dialer, click Dialing Properties. (For more information about this tool, see [Using Dialing Properties.](#))
2. Verify that the area code listed here is correct for your location. (Change it if necessary.) Click OK.
3. Using any method you prefer for storing phone numbers, type the phone number as a 10-digit number, omitting the "1" prefix.

The Windows 95 telephony number translation function sees the local area code in both the location and in the destination number, and assumes it should dial only the local number. For example, suppose you are dialing from area code 905 and can dial phone numbers with area code 416 without the "1" prefix. You would store those numbers as +1 (905) 416xxxxxxx where xxxxxxx is the local phone number.

Using Dialing Properties

Dialing Properties is a utility that has been integrated with Phone Dialer, HyperTerminal, Dial-Up Networking, and other communications applications created for Windows 95.

The options you set with Dialing Properties are stored in the TELEPHON.INI file (instead of the Registry) to ensure backward compatibility with older 16-bit Windows telephony-enabled applications.

With Dialing Properties, you can do the following:

- Define Calling Locations, including specifying area code, country code, and in-house dialing rules
- Define calling card rules

In Windows 95, you can access Dialing Properties from the Tools menu in Phone Dialer, or by clicking the Dialing Properties button when you make a new connection in HyperTerminal. For purposes of discussion, procedures in this section describe accessing Dialing Properties from Phone Dialer.

Defining Calling Locations

A *location* is information that Dialing Properties uses to analyze telephone numbers in international format, and to determine the correct sequence of numbers to be dialed. It need not correspond to a particular geographic location, but it usually does. For example, a location could specify the procedures needed to dial calls from your office, or from a room in a hotel. You can name locations anything you choose to help you remember and select them later. Dialing Properties allows you to add new locations, edit existing locations, and remove locations you no longer need.



To define a location in Dialing Properties

1. Run Phone Dialer, click the Tools menu, and then click Dialing Properties.

Dialing Properties [?] [X]

My Locations

Where I am:

I am dialing from:

The area code is:

I am in:

How I dial from this location:

To access outside line, first dial: for local, for long distance.

Dial using Calling Card:

This location has call waiting. To disable it, dial:

The phone system at this location uses: Tone dialing Pulse dialing

2. In the My Locations properties, type information about where you are calling from, including the following:
 - Name of your location (for example, home or office)
 - Area code
 - Name of country
 - Access number required to make a local or long-distance call
 - Whether your phone has call waiting and whether it should be disabled
 - Whether your phone uses pulse or tone dialing
 - Whether you use a calling card to make calls
3. If you want to change calling card information, click the Change button. For more information about calling cards, see [Defining Calling Card Rules](#).

Defining Calling Card Rules

A *calling card* is information that Dialing Properties uses to create the sequence of numbers to be dialed on a particular call. The calling card can include a calling card number that can be dialed at a specified time during call placement. However, the calling card does not have to specify a card number (in other words, calling cards can also be used to define alternative procedures for direct dialing without a calling card number). To help you remember them, you can name calling cards anything you choose.

Dialing Properties includes predefined settings for several popular calling cards, including AT&T®, Sprint, MCI, British Telecom, France Telecom Mercury, Telecom New Zealand, and others. You can modify and use these directly or copy them to create your own calling cards. Dialing Properties allows you to add new calling cards, edit existing calling cards, and remove calling cards you do not need.

The information stored in a calling card includes the name, card number, and the dialing rules for local, long-distance, and international calls.



To specify that you are using a calling card in Dialing Properties

1. In the My Locations properties, click the Dial Using Calling Card check box.

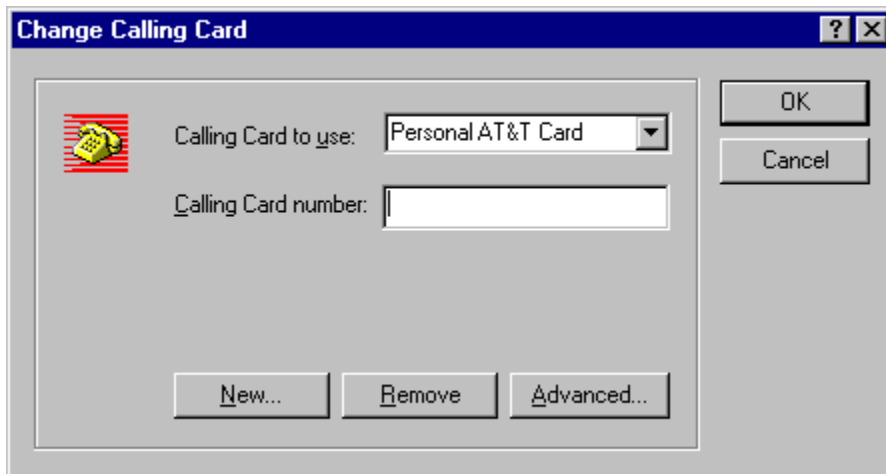

2. In the Change Calling Card dialog box, click your calling card type in the list (for example, AT&T), and then type your calling card number. Click OK.

You can also customize dialing rules by clicking the Advanced button in the Change Calling Card dialog box. The following two examples illustrate how you might use dialing rules.

If you are making a calling-card phone call from outside the United States and do not want Windows telephony applications to automatically add a “0” prefix to the number you are calling, precede the phone number with another numeric code, such as “144” in the following example.



To redefine numbers that automatically precede the phone number

1. In the Change Calling Card dialog box, click the New button, select the name of the calling card and type the card number, and then click the Advanced button.

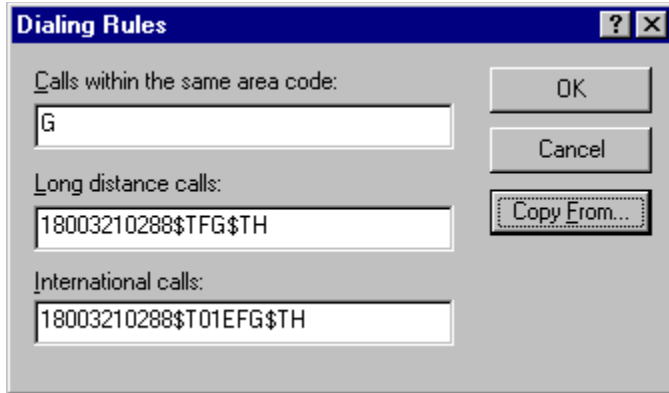

2. In the Dialing Rules dialog box, complete the dialing rule fields. Insert a comma to include a fixed two-second pause; use multiple commas to increase the time. Use the following codes as appropriate.

Code	Description
E	Country code
F	Area code
G	Destination local number
H	Calling card number
W	Wait for a second dial tone
@	Wait for a ringing tone followed by five seconds of silence
\$	Wait for a calling card prompt tone (if your modem supports it)
?	Display an on-screen prompt to the user to continue dialing

For example, if you are using a British Telecom card, you need to precede the number you dial with **144** and complete the fields as follows.

Option	Type
Calls within the same area	144,H,G
Long-distance calls	144,H,0FG
International calls	144,H,00EFG

3. Click OK, and then click OK again. In the My Locations properties, remove the leading zero from your area code (for example, "71" or "81" in London). Click OK.
4. Using Phone Dialer or HyperTerminal (or another tool), store your destination number in international format with only the country code (44), area code (without the leading 0), and local number (+44(71)5551212).

When you choose the Dial option from Phone Dialer or HyperTerminal, the tool you are using automatically expands this number to include "144" and the card number, plus the pause codes.

In another scenario, suppose your organization in the United States uses a PBX system and you need to omit the "1" prefix before the area code. Create a calling card as in the following example.



To omit the "1" prefix with a PBX system

1. In the Change Calling Card dialog box, click New.
2. In the Create New Calling Card dialog box, type a name for your calling card, such as "Direct Dial Through PBX." Click OK.
3. In the Change Calling Card dialog box, click Advanced.
4. In the Dialing Rules dialog box, complete the text boxes and then click OK.

Option	Type
Calls within the same area	G

Long-distance calls	FG
International calls	011EFG

Modems and Communications Tools

Using Microsoft File Transfer

Microsoft File Transfer allows you to send or receive a file while talking on the phone. When you send or receive a file, Microsoft File Transfer switches the phone line to data mode and temporarily suspends voice mode. Microsoft File Transfer switches the phone line back to voice mode when it has finished sending or receiving.

Microsoft File Transfer is automatically installed when you install a modem that supports its file transfer capabilities. For more information, see the online Help for Microsoft File Transfer.

Telephony Drivers from Other Vendors

There are several ways to add telephony drivers from other vendors, if necessary. Some telephony drivers work over the network and consist of software only. If this is the case, the software can be installed through the Add/Remove Programs option in Control Panel.

Hardware drivers can be installed through the Add New Hardware option in Control Panel, unless the hardware requires its own class installer. In this case, the hardware should come with a standard Setup program to install it.

You can also use the Telephony Control Panel, available in the *Win32 Software Development Kit for Windows 95 and Windows NT*, to install telephony drivers from other vendors.

Note If you previously installed the Telephony Control Panel on your Windows 3.1 system, and you upgrade to Windows 95, the Windows 95 Telephony Control Panel will be installed automatically.

Troubleshooting Communications Problems

This section describes how to solve problems with installing modems, making connections, and using applications to access the modem. Windows 95 provides a troubleshooting aid for modems in online Help. Try using online Help for troubleshooting before trying the steps included in this section. In addition, a general modem diagnostic tool is located in the Modems option in Control Panel. It provides information about each modem and COM port that have been configured on the computer.



To use the Modems Diagnostics Tool

1. In the Modems option in Control Panel, click the Diagnostics tab.
2. In Diagnostics properties, click the Driver button to find out which communications driver is installed for Win16-based communications APIs. For these applications, the driver should be COMM.DRV. If a different driver is listed and you are having problems with using Win16-based applications, the driver is probably the cause.
3. In Diagnostics properties, click the More Info button to make sure Windows 95 can communicate with the modem. Clicking this button causes Windows 95 to send commands to and read responses from the modem, and then to display information about the modem and its COM port.

The Port Information box displays the following information:

- The IRQ and I/O address of the modem's COM port. These should match the physical configuration of the port or modem adapter.
- The UART type of the COM port, for example, 8250 or 16550A. Notice that 16550A UART ports can sustain faster connection speeds with fewer errors.
- The highest port speed supported by the modem. Never set the modem's speed higher than the speed listed here.

The Modem Information box displays the modem's responses to various AT commands that Windows 95 previously sent to it. Some modems return a response that indicates what make and model it is. This can help you select the correct modem if the Install New Modem wizard did not detect it correctly. Notice that many modems return "ERROR" for some AT commands. This means that the modem does not support that particular AT command.

The Record a Log File option in the Modems option also helps you identify modem problems by recording modem commands and responses in a MODEMLOG.TXT file, as described in [Setting Modem Properties](#).

Correcting Problems with Modem Installation

This section describes situations that can interfere with installation of a modem, and how to fix them.

The Install New Modem wizard detected the modem as a standard modem.

This does not indicate a problem. Rather, it means that Windows 95 was unable to detect the exact make and model of a modem. Most communications applications work correctly with the Standard Modem option, that is, connections can be made successfully using the modem's factory default settings. However, advanced control of some features, such as speaker volume, error control (for example, V.42 protocol), and compression (for example, V.42bis protocol) will be disabled in the modem's properties.

If you do not want to use the Standard Modem option, you can run the Install New Modem wizard to select a specific type of modem that is similar to the modem you are using. If you specify another, similarly named model from the same manufacturer — for example, if you configure the modem as a Practical Peripherals PM9600HC when a Practical Peripherals PM9600FX modem is actually installed — Windows 95 usually treats the models as being identical and the specified configuration will probably work well.

To determine whether other modem models are compatible with the one you are using, check the modem manual. Many modems are compatible with Hayes®, Microcom®, Rockwell, or U.S. Robotics models.

The Install New Modem wizard did not detect any new modems.

- Make sure the modem does not already appear in the list of installed modems. Windows 95 will not redetect modems that are already installed.
- Make sure no other programs are running that might be using the modem or its COM port.
- If the modem is external, check the connection between it and your computer, and reset it by turning it off and on again.
- If the modem is internal, make sure that its built-in COM port has been configured properly in Device Manager in the System option in Control Panel. If it does not appear, run the Add New Hardware wizard to allow Windows 95 to detect and configure it.
- Make sure the modem's COM port is active and has a correct IRQ by checking its Resources configurations in Device Manager in the System option in Control Panel. Make sure the IRQ does not conflict with one in use by another device. For details, see [Devices](#).

If the Install New Modem wizard still does not detect a modem, then there is probably a problem with the port, the cable, or the modem itself. Try the modem with an MS-DOS-based communications program, or with another computer, if possible.

The Install New Modem wizard does not detect a PCMCIA modem.

If the Windows 95 PCMCIA drivers are loaded, then Windows 95 should automatically detect and configure a PCMCIA modem when it is installed. Use the PCMCIA option in Control Panel to check the configuration of a PCMCIA socket driver.

If the Windows 95 PCMCIA drivers are *not* being used, then the modem card must be configured as a COM port before the Install New Modem wizard can detect and configure it as a modem.



To detect and configure a PCMCIA modem when Windows 95 PCMCIA drivers are not used

1. Configure the modem according to the instructions that came with your original PCMCIA driver software.
2. Run the Add New Hardware wizard to detect and configure the card as a COM port.
3. Run the Install New Modem wizard to detect and configure the card as a modem.

For more information about PCMCIA devices, see [Devices](#).

Correcting Connection Problems

This section describes basic steps for troubleshooting communications and explains specific communications errors or problems and how to correct them.

Modem will not dial or will not answer.

If your modem is not set up correctly, communications features might not function properly. The following procedures list steps in verifying the correct operation of your modem and the Windows 95 communications subsystem.

Because some communications programs designed for Windows 3.1 install incompatible driver files, which can cause COM ports and modems to stop working, start by verifying that the correct Windows 95 files are being loaded.



To verify that the required communications files are present

1. Verify file sizes and dates of COMM.DRV and SERIAL.VXD in the SYSTEM directory against the original versions from the Windows 95 floppy disks or compact disc.
2. Confirm that the following lines are present in SYSTEM.INI:

```
[boot]
comm.drv=comm.drv
[386enh]
device=*vcd
```

3. To revert to the default communications drivers for Windows 95, delete communications port entries in Device Manager.
4. Run the Add New Hardware wizard in Control Panel to detect and install the Windows 95 drivers.

Note Windows 95 does not load the SERIAL.VXD driver in SYSTEM.INI. Rather, Windows 95 loads it on demand by using the Registry. Also, there is no corresponding file for the *vcd entry in SYSTEM.INI. This is an internal file built into VMM32.VXD.



To verify the modem configuration by using the Modems option in Control Panel

1. In General properties, verify that the manufacturer and model for your modem are correct. If not, you might have changed the modem and failed to reconfigure it. In this case, run the Install New Modem wizard to detect the modem and confirm it with the current Registry configuration.
2. If your modem does not appear in the list of installed modems, click Add, and then select the appropriate modem.
3. If the manufacturer and model are not correct and are not available from the list, try the Hayes-compatible option or the Generic Modem driver option, set to the maximum speed supported by the modem. Click OK.
4. Try removing any other modem entries in the list to eliminate any conflicts.



To verify that the modem is enabled by using the System option in Control Panel

1. Click the Device Manager tab, click a modem from the list, and then click Properties.
2. Click the option named The Device Is Present, Please Use It, if this is not already selected.



To verify that the port is correct by using the Modems option in Control Panel

1. In General properties, click a modem, and then click the Properties button.
2. In General properties for that modem, verify that the listed port is correct. If not, select the correct port. Click OK.



To determine if a serial port's I/O address and IRQ settings are properly defined by using the System option in Control Panel

1. Click the Device Manager tab, click Ports, and then click a specific port (such as COM2).
2. Click the Properties button, and then click the Resources tab to display the current resource settings (IRQ, I/O) for that port. To find the correct settings, consult the modem manual.
3. In the Resources properties, check the Conflicting Devices List to see if the modem is using resources in conflict with other devices.
4. If the modem is in conflict with other devices, click the Change Setting button, and then click a Basic Configuration that does not cause resource conflicts.

Note Do not try to use a modem on COM3 if there is a serial mouse or other device on COM1. Usually, COM1 and COM3 ports use the same IRQ, meaning that they cannot be used simultaneously on most computers. The COM2 and COM4 ports have the same problem. If possible, change the COM3 or COM4 port to an IRQ setting that is not in conflict.

Also, some display adapters (especially S3, 8514A and ATI mach8) have an address conflict with COM4 ports. You can work around this by using another COM port or replacing your display adapter.



To check the port settings by using the Modems option in Control Panel

1. Click a modem in the list box, and then click Properties.
2. Click the Connection tab to check the current port settings, such as bits per second (speed), data bits, stop bits, and parity.
3. Click the Advanced button to check error control and flow control. If you are using Win16-based applications, turn off these advanced features.
4. Verify the UART type.

Data transmission problems can occur if a speed greater than 9600 is selected on a slower 80386-based computer not equipped with a 16550 UART, or when performing other tasks during a file download. If problems or errors occur during transmission, try lowering the speed. Attempting to use speed greater than 9600 on computers equipped with 8250 or 16450 UARTs will probably result in dropped characters.



To check the modem speed by using the Modems option in Control Panel

1. Click a modem in the list box, and click the Properties button.
2. In General properties, check the speed to make sure it isn't set too high for either the modem or computer. Lower speeds might work, especially when using an older, slower computer.
3. Click the option named Only Connect At This Speed if it is not already selected.

Tip To optimize communications performance, you can set the speed higher if your computer has an 80486 or a Pentium processor.



To disable hardware flow control if your modem cable doesn't support it

1. In the Modems option in Control Panel, click a modem in the list box, and then click the Properties button.
2. Click the Connection tab, and then click the Advanced button.
3. If a check appears in the Use Flow Control check box, click the box to clear it.



To remove VxDs from other vendors that might be interfering with modem operation

- Search for and comment out (type a semicolon as the first character of the line) any related entries in the SYSTEM.INI file. When commenting out a line in SYSTEM.INI, it is useful to add a comment line noting this.

The initialization (dialing) string is improper for the modem.

If the modem will not pick up the line and dial, it might be due to an improper initialization string. Typically, the manufacturer's recommended dial command string is loaded from the corresponding modem INF file; however, if your modem driver was not available and you selected a compatible modem, the dial command string might not work correctly. Try using the modem types, and retest the

modem dialing the selected number.

The modem repeatedly drops the connection.

- Check for a bad or loose serial cable to the modem. If all connections are tight, test for a faulty cable by replacing it with a working cable, and retest the modem communications.
- Check the connection between the RJ-11 phone outlet and the modem. Verify that the connection is firmly plugged in and well connected.
- Try using a different phone line. If you have ruled out other factors, consistent modem errors might be due to problems in the telephone line used for communication.
- Disable call waiting, if it is in use. The call waiting feature can interfere with remote connections and file transfers. If you use this feature regularly, disable it only temporarily (during the time the modem is in use).
- Check communications with the host computer. The communications problems might be due to the host computer not connecting or repeatedly dropping the line.
- Try using a lower speed in the modem properties in the Modems option in Control Panel.

The COM ports remain in Device Manager after the modem is removed.

After installing an internal modem and assigning it to a COM port that does not physically exist on your computer, the port appears in the Device Manager. After removing this adapter, you might also need to manually remove the port in Device Manager as described in [Devices](#).

You are unable to dial international calls.

Windows 95 allows you to set specific modem properties that assist you when making international calls over your modem. You set these properties in Dial-Up Networking, Dialing Properties, and in the modem properties.



To check location and calling card settings

1. In Phone Dialer, click Tools, and click Dialing Properties.
2. In the My Locations properties, verify that your calling location and calling card settings are correct.



To disable dial-tone detection if your modem fails to detect a dial tone

- In the Modems option in Control Panel, click the Connection tab, and click to clear the check box next to the Use Dial Tone option.



To increase the time between dialing if connections are taking a long time

- In the Modems in Control Panel, click the Connection tab, and then increase the number of seconds in the Cancel the Call If Not Connected Within option.

To manually control modem dialing, see [Dialing Manually](#). To display a terminal window to type AT commands before or after dialing, see [Displaying the Terminal Window](#).

Correcting Modem Access Problems with Applications

You cannot send or receive binary files by using HyperTerminal.

- Make sure that both computers are using the same file transfer protocol (that is, Xmodem, 1K Xmodem, Ymodem, Ymodem-G, Zmodem, or Kermit).
- If you are using the Ymodem-G file transfer protocol, ensure that your modem supports hardware error control. If it doesn't, try using Ymodem instead.
- If you are trying to use an alternative protocol (such as Kermit) and you encounter transmission errors, try Xmodem instead. Most communications packages, bulletin boards, and online services support Xmodem.

You cannot dial with Phone Dialer.

- In the Dialing Properties dialog box, make sure your area code and country code are correct.
- For each access number you want to use for calling out, specify, at a minimum, the country code, area code, and telephone number.
- Verify basic modem and port configurations.

Win16-based applications cannot access the modem, but MS-DOS-based or Windows 95-based applications can.

Make sure the communications driver for Windows 3.1-based applications is COMM.DRV in the SYSTEM.INI file. Some applications replace this driver for various reasons.

MS-DOS-based applications cannot access the modem (especially PCMCIA modems), but all Windows-based applications can.

- If possible, adjust the IRQ setting in the MS-DOS-based application according to the application's documentation.
- If the MS-DOS-based application's IRQ settings cannot be adjusted, adjust the IRQ settings for the modem COM port as described earlier in this section.

MS-DOS-based and Windows 3.1-based applications cannot access the modem, but applications created for Windows 95 can.

Make sure that Microsoft Exchange Remote Mail, Microsoft Fax, and Dial-Up Networking are not waiting for incoming calls. If they are, older applications cannot access the modem.

Errors occur during MS-DOS-based applications communications sessions, especially file transfers.

Increase the **COMxBuffer** setting in [386Enh] section of SYSTEM.INI. The default value is 128 bytes.

Introduction

This chapter describes the electronic mail and messaging features of Windows 95, including the Microsoft Exchange client. Microsoft Exchange provides a central place for sending and receiving messages within a workgroup and to and from other messaging services, such as electronic mail, faxes, and online services.

- [Microsoft Exchange: The Basics](#)
- [Microsoft Exchange: The Issues](#)
- [Overview of Microsoft Exchange and Windows 95 Messaging](#)
- [Setting Up the Microsoft Exchange Client](#)
- [Using the Microsoft Exchange Client](#)
 - [Using the Personal Address Book](#)
 - [Configuring Addresses and Delivery Options](#)
 - [Personal Folder Files](#)
 - [Sorting and Viewing Messages](#)
 - [Using Message Finders](#)
- [Working with Documents](#)
- [Using Multiple Microsoft Exchange Profiles](#)
- [Using the Microsoft Exchange Client with Microsoft Mail](#)
 - [Upgrading from Windows For Workgroups](#)
 - [Setting Up a Microsoft Mail Workgroup Postoffice](#)
 - [Postoffice Directory Structure](#)
 - [Setting Up Microsoft Mail on Other Network Servers](#)
- [Accessing a Microsoft Mail Workgroup Postoffice Remotely](#)
 - [Configuring Microsoft Mail for Remote Access](#)
 - [Defining Scheduled Sessions](#)
 - [Selecting Messages to Download](#)
- [Technical Notes on the Microsoft Exchange Client and MAPI](#)
- [Upgrading to Microsoft Mail Server](#)
- [Upgrading to Microsoft Exchange Server](#)
- [Microsoft Mail Gateways](#)
 - [Microsoft Gateway to Fax](#)
 - [Microsoft Mail Gateway to MHS](#)
 - [Microsoft Mail Gateway to X.400](#)
 - [Microsoft Mail Gateway to SMTP](#)
 - [Microsoft Mail IBM PROFS and OfficeVision Gateway](#)

Microsoft Exchange: The Basics

Windows 95 includes the Microsoft Exchange client, an advanced messaging application that retrieves messages into one inbox from many kinds of messaging service providers, including Microsoft Mail, The Microsoft Network, and Microsoft Fax. Its integration with Microsoft Fax software allows you to send rich-text documents as faxes or mail messages. Setting up Microsoft Exchange to communicate with service providers is as easy as connecting to different printers in a network environment.

With Microsoft Exchange client, you can do the following:

- Send or receive electronic mail in a Windows 95 workgroup
- Include files and objects created in other applications as part of messages
- Use multiple fonts, font sizes and colors, and text alignments in messages
- Create a Personal Address Book or use address books from multiple service providers
- Create folders for storing related messages, files, and other items
- Organize and sort messages in a variety of ways
- Send and receive messages to and from the following service providers:
 - Microsoft Mail
 - The Microsoft Network (online service)
 - Microsoft Fax
 - Other messaging services that use messaging application programming interface (MAPI) service providers

Microsoft Exchange: The Issues

Before installing and configuring electronic mail on a network, you should decide the following issues:

- What electronic mail system will you use? Do you want to communicate with others in a workgroup, or with people on the Internet or other online services? For communicating within one workgroup, Windows 95 provides a complete Microsoft Mail workgroup postoffice and a wizard for setting it up. For communicating among workgroups, you will need to upgrade to Microsoft Mail Server, as described in [Upgrading to Microsoft Mail Server](#).

- If you use the built-in Microsoft Mail workgroup postoffice, where will it be located, and who will administer it? The postoffice can reside on any computer in the workgroup. For best results, that computer should have ample hard disk space to contain message files, be accessible to users at all times, and have at least 8 MB of memory (RAM).

To begin with you should allow approximately 2 MB of storage on the mail server. As the number of users and the size of stored mail messages increases, you will need to increase storage for the postoffice. When you have more than 20 users, consider using a dedicated computer for the workgroup postoffice.

Be sure to determine the location of the postoffice before you configure Microsoft Exchange. If you choose Microsoft Mail during Setup, Windows 95 runs the Inbox Setup wizard at the end of Setup, but you cannot fully configure Microsoft Exchange if you have not created a postoffice. After Windows 95 Setup, you can configure the Microsoft Mail workgroup postoffice by running the Microsoft Workgroup Postoffice Admin wizard in Control Panel. For information, see [Using the Microsoft Exchange Client with Microsoft Mail](#).

- Which service providers, such as Microsoft Fax, do users need to connect to? Requirements for connecting to service providers vary depending on the type of service. For example, connecting to The Microsoft Network requires that the user has a modem, Dial-Up Networking, a phone line, and an account from The Microsoft Network. You choose the service providers you want during Setup or afterward in the Mail And Fax option in Control Panel or from within Microsoft Exchange. For details, see [Setting Up the Microsoft Exchange Client](#).
- Do you want users to connect to service providers from their individual computers or from the network? For security purposes, a network administrator might want to restrict users from communicating with other service providers from their computers. If you want users to connect to service providers through a gateway on a network server, you must purchase a gateway and an electronic mail system that allows you to connect to a gateway. For example, if you are running Microsoft Exchange with Microsoft Mail workgroup postoffice, you must upgrade the workgroup postoffice to Microsoft Mail Server and purchase a gateway. For information, see [Upgrading to Microsoft Mail Server](#) and [Microsoft Mail Gateways](#).
- Will users connect to the postoffice from a remote site? If so and you are using the Microsoft Mail workgroup postoffice, you need to create a Dial-Up Networking connection to the postoffice and configure a remote access server for dial-up clients. For information, see [Dial-Up Networking and Mobile Computing](#).

Note If you install the Microsoft Exchange client and Microsoft Schedule+ 1.0, you will lose group scheduling capabilities.

Overview of Microsoft Exchange and Windows 95 Messaging

The Microsoft Exchange client can communicate with any electronic mail system or messaging application that has a *MAPI service provider*, which is similar to a personal gateway. It specifies all the connection and addressing settings needed to communicate with a mail server on one end and with the Microsoft Exchange client on the other end.

MAPI is a set of API functions and OLE interface that allows messaging clients, such as Microsoft Exchange, to interact with various message service providers, such as Microsoft Mail and Microsoft Fax. MAPI helps Microsoft Exchange manage stored messages and define the purpose and content of messages. For more information about MAPI, see [Technical Notes on the Microsoft Exchange Client and MAPI](#).

The Microsoft Exchange client includes an OLE-compatible rich-text editor used for reading and composing messages; it supports the use of bullets, multiple font sizes and colors, and text alignments in messages.

If you install the Microsoft Exchange client, Windows 95 provides several MAPI service providers. To install the Microsoft Mail workgroup postoffice to work with Microsoft Exchange, you must select it as a separate component under Microsoft Exchange during Windows 95 Setup or afterward by using the Add/Remove Programs option in Control Panel.

Microsoft Mail workgroup postoffice.

This postoffice is a workgroup edition of the Microsoft Mail Server, allowing one computer to host the postoffice and allowing other users to access that postoffice to send and receive mail. The workgroup postoffice provides the same features as the full Microsoft Mail Server, with the following exceptions:

- No mail exchange with users of other postoffices
- No access to Microsoft Mail gateways
- Simplified administration tools

Personal Address Book MAPI service provider.

This common address book can store electronic mail addresses and other personal messaging information such as names, phone and fax numbers, and mailing addresses from multiple messaging service providers. A Personal Address Book is accessible from applications that use MAPI.

Personal Folder (.PST) MAPI service provider.

The Personal Folder stores messages, forms, documents, and other information in a series of hierarchical folders. A Personal Folder acts as a universal inbox and outbox where users can send and receive messages from multiple service providers.

Microsoft Mail Services MAPI service provider.

This service provider connects the Microsoft Exchange client to either the Microsoft Mail workgroup postoffice or a Microsoft Mail Server (acquired separately) postoffice. To connect a computer running Windows 95 to the Microsoft Mail Server postoffices, the postoffices must reside on a network file server (such as Windows NT 3.5 or Novell®NetWare®) that supports the MS-DOS driver redirector.

See [Using the Microsoft Exchange Client with Microsoft Mail](#) for information about configuring and using the Microsoft Exchange client with a Microsoft Mail workgroup postoffice.

Microsoft Fax MAPI service provider.

This service provider allows the Microsoft Exchange client to send and receive faxes in the same way as electronic mail. You can receive faxes in the same universal inbox as your mail, and use the same Personal Address Book for both mail and fax recipients. For more information, see [Microsoft Fax](#).

The Microsoft Network MAPI service provider.

This service provider allows the Microsoft Exchange client to send and receive mail on The Microsoft Network, an online service accessible from the Windows 95 desktop. For details, see [The Microsoft Network](#).

Internet Mail MAPI service provider.

This service provider allows the Microsoft Exchange client to send and receive mail directly on the Internet or other networks using the Simple Mail Transport Protocol (SMTP) and the Post Office

Protocol 3 (POP3) over TCP/IP. This product is available as part of Microsoft Plus! for Windows 95. For information, contact your Microsoft sales representative.

CompuServe Mail MAPI service provider.

This service provider allows the Microsoft Exchange client to send and receive mail using the CompuServe Mail Services. To use this service provider, you must have an account with CompuServe. For more information, contact CompuServe.

Microsoft Exchange Server MAPI service provider.

This service provider will allow the Microsoft Exchange client to connect to the Microsoft Exchange server, which is a client-server messaging system that runs on Windows NT Server. This Microsoft product will be available after the release of Windows 95.

Installing the Microsoft Exchange server will provide the Microsoft Exchange client with specific functionality, including the following:

- Inbox Assistant, a set of server-based rules for filtering, forwarding, replying to, and deleting messages
- Out of Office Assistant, a set of server-based rules for automatically forwarding and replying to mail when users are working away from the office

Setting Up the Microsoft Exchange Client

Installing and configuring the Microsoft Exchange client consists of the following steps:

- Install the Microsoft Exchange client either during Windows 95 Setup or afterward in the Add/Remove Programs option in Control Panel or by double-clicking the Inbox on the Windows 95 desktop. The Microsoft Exchange client is installed automatically if you choose to install Microsoft Fax, The Microsoft Network, or Microsoft Mail in the Get Connected dialog box during Setup. For information, see [Introduction to Windows 95 Setup](#). You can also install the Microsoft Exchange client after Windows 95 Setup in the Add/Remove Programs option in Control Panel.
- Choose the electronic mail system to which you will connect the Microsoft Exchange client.
- Set up a mail postoffice. If you choose the built-in Microsoft Mail workgroup postoffice and you are upgrading from previous Windows for Workgroups Mail or Microsoft Mail 3.2 postoffices, you will not need to set up a new Microsoft Mail workgroup postoffice.
- Set up the Microsoft Exchange client by running the Inbox Setup wizard either during Windows 95 Setup or afterward in the Mail And Fax option in Control Panel.
- Choose the service providers you want during setup of the Microsoft Exchange client, or afterward in the Mail And Fax option in Control Panel or in the Microsoft Exchange client.

Important If a Microsoft Mail workgroup postoffice or another postoffice has not yet been set up when a user runs the Inbox Setup wizard, the Microsoft Exchange client can be only partially configured. After setup, the postoffice administrator can configure the Microsoft Mail workgroup postoffice for all users in the workgroup in the Microsoft Mail option in Control Panel. When those users run the Microsoft Exchange client for the first time, the postoffice location automatically appears in the postoffice location box.



To install the Microsoft Exchange client after Setup

1. In the Add/Remove Programs option in Control Panel, double-click the Windows Setup tab.
2. In the Components list, click Microsoft Exchange, and then click OK.

-Or -

Double-click the Inbox on the Windows 95 desktop.

The Inbox Setup wizard guides you through the configuration steps. If you choose to add Microsoft Mail Services to Microsoft Exchange, the wizard prompts you for the postoffice location (path name), user name, and password.

If you have already created a postoffice, added users to it, and shared it with all users on the network, the postoffice name and location automatically appear in the dialog box without requiring the user to type them. In this way, setting up the Microsoft Exchange client with the Microsoft Mail workgroup postoffice is seamless for all users in the workgroup except the postoffice administrator. For information about setting up a Microsoft Mail workgroup postoffice, see [Using the Microsoft Exchange Client with Microsoft Mail](#).

3. After the wizard has finished, shut down and restart Windows 95 for the changes to take effect.



To add a service provider

- Double-click the Mail And Fax option in Control Panel, and then click Add.

-Or -

1. From the Tools menu in Microsoft Exchange, click Options.
2. In the Options properties, click the Services tab, and then click Add.
3. In the Add Services To Profile dialog box, click the service providers you want, and then click Add. For information about Microsoft Exchange profiles, see [Using Multiple Microsoft Exchange Profiles](#).

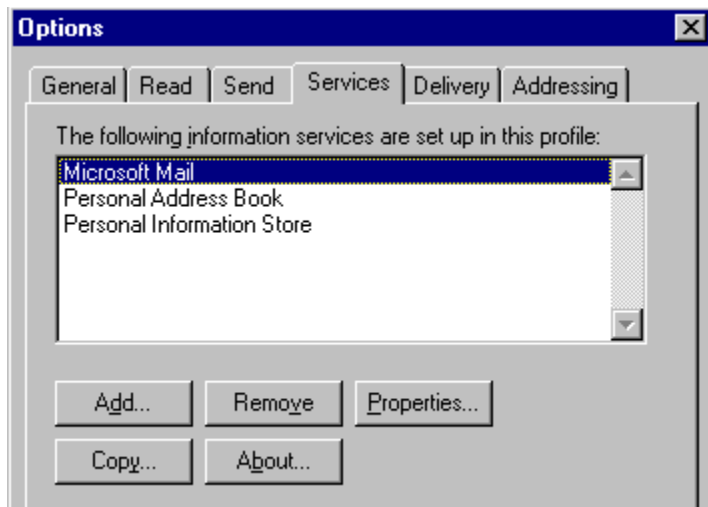

The services you select determine which specific DLLs are enabled when the Microsoft Exchange client is started. For example, if the Microsoft Mail service is added, the MSFS32.DLL file in the Windows SYSTEM directory is loaded. (To find out which DLLs are loaded for a service, click the name of that service in the Microsoft Exchange properties, then click the About button.)

The service providers each provide a setup wizard that prompts you for any required configuration information. For information about Microsoft Mail, see [Using the Microsoft Exchange Client with Microsoft Mail](#).

Tip When you're troubleshooting Windows 95 mail issues, first remove additional service providers (except Personal Address Book and Personal Folder), and then add back each service provider, one at a time.

Using the Microsoft Exchange Client

This section describes how to use the Microsoft Exchange client, including discussions about Personal Address Book, Personal Folder, and sorting and viewing messages.



To start the Microsoft Exchange client

- On the Windows 95 desktop, double-click the Inbox.
- Or -
- On the Programs menu, click Microsoft Exchange.

Note The Microsoft Exchange client opens in single-pane view if you start it by double-clicking the Inbox on the Windows 95 desktop. In single-pane view, folders and messages appear in one window. Clicking the Show/Hide Folder List button on the toolbar in Microsoft Exchange switches to double-pane view. In double-pane view, you can drag and drop messages into folders.

The Microsoft Exchange client automatically downloads mail from all service providers when you first open your Inbox. Consequently, if you have added multiple service providers to the Microsoft Exchange client, it might take several minutes to connect to and download mail from each of them.

After you open the Microsoft Exchange client, you can choose to download mail from service providers one at a time or from all of them at once. You can also set time intervals for downloading mail from each service provider in the properties for each of them.



To download mail after you open the Microsoft Exchange client

- On the Tools menu, click Deliver Now Using, and then point to each service provider from which you want to download mail. If you installed only one service provider, the option on the Tools menu is named Deliver Now.

Using the Personal Address Book

The Microsoft Exchange client creates a Personal Address Book for each user when the Inbox Setup wizard is run for the first time. The Personal Address Book contains the names and addresses of people to whom users commonly send electronic mail and fax messages. Users can add names and addresses to the Personal Address Book from other electronic address books, such as the Postoffice Address List that comes with the Microsoft Mail workgroup postoffice. Users can also modify the Personal Address Book (they cannot modify address books from other service providers, such as The Microsoft Network).

With the Personal Address Book, you can do the following:

- Find and select names within different address books.
- Modify names and addresses.
- Copy addresses from other address books into the Personal Address Book.
- Add custom addresses to send messages to other messaging services, such as The Microsoft Network.
- Define groups of recipients (distribution lists) to which you want to send the same message.

Tip You can address a mail message to selected recipients from within the Personal Address Book dialog box by selecting a name, and then clicking New Message on the File menu.



To find and select names within a Personal Address Book

1. In Microsoft Exchange, click the Tool menu, and then click Address Book.
2. In the Address Book dialog box, click Personal Address Book in the Show Names From box. The names in the Personal Address Book are displayed in the list box to the left.
3. To find a name, type it in the blank box above the list. The cursor automatically moves to that name in the list.
4. If you can't find a name, click the Edit menu, and then click the Find button. In the Find dialog box, type letters that are part of the name you want to search for, and then click OK.



To modify names and addresses in the Personal Address Book

1. In the Address Book dialog box, click the Personal Address Book in the Show Names From box, and then double-click a name in the list.
2. In the properties for that name, change the address, phone, business, and other information, and then click OK.



To add names and addresses to a Personal Address Book from another address book

1. In the Address Book dialog box, click a different address book in the Show Names From box.
2. In that address book's list of names, click a name, click the File menu, and then click Add To Personal Address Book.



To add a custom name and address to the Personal Address Book

1. In the Personal Address Book, click New Entry on the File menu.
2. In the New Entry dialog box, click the type of address you want to add to the Personal Address Book.

For example, if the person is a member of The Microsoft Network, select The Microsoft Network. In the Microsoft Network address dialog box, type the Member ID and Name.

Each messaging service has a different address dialog box. For example, if you select Internet, you must enter the SMTP and Alias of the recipient.

All messaging services include dialog boxes named Notes, Business, and Phone in which you can store additional information about the recipient.



To create a personal distribution list

1. In Microsoft Exchange, click the Tools menu, and then click Address Book.
2. In the Address Book dialog box, click File, and then click New Entry.
3. In the New Entry dialog box, double-click Personal Distribution List.
4. In the Distribution List dialog box, type a name for the personal distribution list, and then click the Add/Remove Members button.
5. In the Edit Personal Distribution List Members box, type a name or select it from the displayed address book, and then click Members to add it to the personal distribution list. You can add as many names as you want. When you are finished, click OK.
6. In the Distribution List dialog box, click OK to add the personal distribution list to the Personal Address Book.



To address a message to a personal distribution list

1. In Microsoft Exchange, click the Tools menu, and then click Address Book.
2. In the Address Book, click Personal Address Book in the Show Names From box.
3. In the Personal Address Book's list of names, select the name of the personal distribution list, click the File menu, and then click New Message.

A message form appears with the name of the personal distribution list in the To: box.



To select names when composing a message

1. In Microsoft Exchange, click the Compose menu, and then click New Message.
2. In the new message form, click the Select Names button on the toolbar.
3. In the Select Names dialog box, click a name, and then click OK to address the message.

Configuring Addresses and Delivery Options

You can control how a message is addressed and delivered by specifying the following address and delivery options:

- The address book to be displayed first when selecting mail recipients
- The address book to search first when looking for names that have been added manually
- The address book in which to store personal names
- The Personal Folder to which messages are delivered
- The order in which service providers should send outgoing messages



To configure address options in the Microsoft Exchange client

1. In Control Panel, double-click the Mail And Fax option, and then click the Addressing tab.
-Or -
From the Tools menu in Microsoft Exchange, click Options, and then click the Addressing tab.
2. In Addressing properties, click an address book in the option named Show This Address List First.
3. Click an address book in the option named Keep Personal Addresses In.
4. To specify the search order of address books, click an address book in the option named When Sending Items, and then click the up or down arrows to the right of the list box to set the order by which the Microsoft client searches address books.



To configure delivery options in the Microsoft Exchange client

1. In Control Panel, double-click the Mail And Fax option, and then click the Delivery tab.
-Or -
From the Tools menu in Microsoft Exchange, click Options, and then click the Delivery tab.
2. In Delivery properties, choose a Personal Folder File in the option named Deliver New Items To The Following Location.
3. To specify a second delivery location in case a network connection to a file server is temporarily lost, type the name of a secondary Personal Folder File in the Secondary Location box.
4. To specify an order in which service providers send messages, click a service provider in the option named Recipient Addresses Are Processed By, and then click the up or down arrows to the right of the list box to set the order in which service providers send messages.

Personal Folder Files

A Personal Folder File, located on a local computer, stores mail messages, forms, and other information in a series of hierarchical folders. The Personal Folder functions as your universal inbox and outbox for sending messages to and receiving messages from service providers.

When you upgrade to Windows 95 from Windows for Workgroups Mail or Microsoft Mail 3.2, Windows 95 runs a Migration wizard to convert the primary message files (.MMF) to a Personal Folder File (PST format, as described in [Upgrading from Windows For Workgroups](#)). During Setup, Windows 95 looks first in the Windows subdirectory and then in the MSMAIL subdirectory for an .MMF file. It considers the first .MMF file it finds as the primary .MMF file and converts it. After Setup, you can convert additional .MMF files to Personal Folder format by using the Import Mail Data option in the Microsoft Exchange client. You can also use this option to convert previous Personal Address Books (.PAB files).



To convert .MMF or .PAB files in the Microsoft Exchange client

1. In the File menu, click Import.
2. In the Specify File To Import dialog box, type the path to the .MMF or .PAB file you want to import, and then click Open.
3. In the Import Mail File dialog box, verify that the .MMF or .PAB is the one you want to import, and then click OK.

The wizard leaves your original .MMF and .PAB files intact and copies the messages into the current Personal Folder or Personal Address Book.

Important The Microsoft Exchange client, unlike the Microsoft Exchange Server, does not support shared or replicated sets of folders to let large groups of people share documents and messages, and create rich views on them. If you have previous shared folders, they cannot be converted in the Microsoft Exchange client. You will lose the mail in these shared folders when you upgrade to Windows 95 unless you import the shared folders to another .MMF file.

You can add as many Personal Folder Files as you need. For example, you might want to create one Personal Folder File for archived messages and one for current messages. Or you could choose to have one Personal Folder File for messages from a specific service provider. However, no matter how many service providers you add to the Microsoft Exchange client, you need only one Personal Folder File.



To add a Personal Folder File in the Microsoft Exchange client

1. In the Tools menu, click Options.
2. In the Options dialog box, click the Services tab, and then click Add.
3. In the Add Service To Profile dialog box, click Personal Folder, and click OK.
4. In the Create/Open Personal Folder dialog box, type a filename for the Personal Folder File, and then click Open.

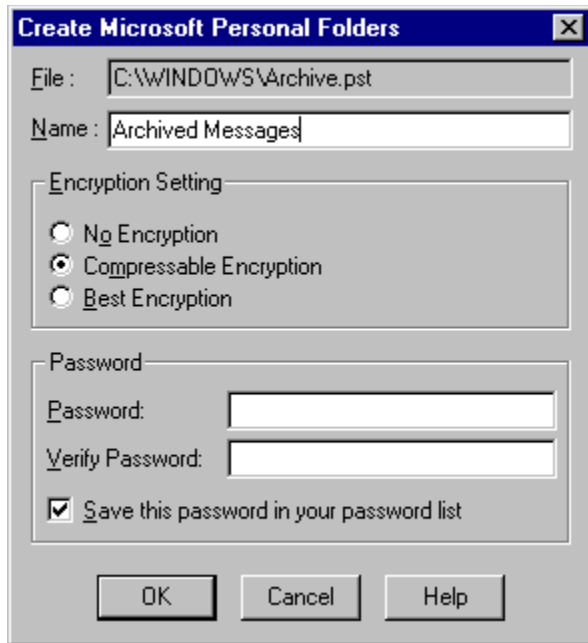

5. In the Create Microsoft Personal Folders dialog box, type a name for the Personal Folder File. This name will appear in the Microsoft Exchange client Inbox. Click the type of encryption you want, and then type a password. Click OK.

Notice that Compressible Encryption is selected by default. The Personal Folder also supports password protection to maintain the privacy of your electronic mail.

To help you manage the size of a Personal Folder, Windows 95 provides a Personal Folder compression feature. Choosing to compress a Personal Folder eliminates the empty spaces created when you delete messages.



To compress a Personal Folder in the Microsoft Exchange client

1. From the Tools menu, click Services, and then click a Personal Folder File.
2. In the Personal Folders dialog box, click Compact Now.

Note Because a Personal Folder is a file in the Exchange subdirectory, it can be backed up in the same way as other files in Windows 95.

Electronic Mail and Microsoft Exchange

Using the Microsoft Exchange Client

Sorting and Viewing Messages

The Microsoft Exchange client provides a number of ways for you to organize and manage electronic mail messages and other information. When you first use Microsoft Exchange, messages are arranged according to the date and time they were received, the sender's name, their subject, and size. You can reorganize how messages are arranged in a single folder or all folders in the following ways:

- Create a series of folders to keep groups of messages in each.
- Sort messages within a folder by category, such as the message subject title, the sender's name, and so on.

For information about performing these tasks, see the online Help for the Microsoft Exchange client.

Using Message Finders

A message finder is a separate window that works in the same way as a filter to find messages that meet a particular set of criteria. When set up, a finder can run continuously, alerting you when matching messages arrive. The selection criteria for finding messages are the same as for filtering messages.



To view a message finder window in the Microsoft Exchange client

1. From the Tools menu, click Find.
2. Specify the criteria you want to use to find messages. Click Advanced to find messages according to its size, date, importance, or sensitivity.

Note You can add OLE fields to the columns you want to view, or you can sort, filter, and search on these fields (in addition to the normal messaging properties). For more information about OLE in Windows 95, see [Application Support](#).

Working with Documents

You can attach files, messages, or objects to a mail message in Microsoft Exchange. You can also drag and drop files into Microsoft Exchange, or drag and drop files attached to messages to other drives, folders, or documents on a local or networked computer. To use this OLE functionality, you must be in double-pane view. A button is provided on the Microsoft Exchange client toolbar to switch between single and double-pane view.



To attach files, messages, or objects to messages in the Microsoft Exchange client

- In a Microsoft Exchange message, click the Insert menu, and then click File, Message, or Object.



To drag and drop files attached to messages

- In the Microsoft Exchange Inbox, double-click the file and drag it to another folder in the Microsoft Exchange client or to a drive or folder in My Computer or Network Neighborhood. Windows 95 saves the file as an .MSG file.

Note To drag and drop files to another folder, the Microsoft Exchange client must be in double-pane view.



To drag and drop files into a message in the Microsoft Exchange client

- In My Computer or Network Neighborhood, double-click a file and drag it into an open Microsoft Exchange message or folder.

Tip You can use Microsoft Exchange folders as an alternate way to store and sort files. Consider creating a hierarchy of folders to store and categorize files, creating a personalized document library. You can create more elaborate and customized views in the Microsoft Exchange client than is possible in the Windows 95 file system.

Using Multiple Microsoft Exchange Profiles

The Microsoft Exchange client maintains one or more separate profiles for each user. A profile contains default settings for how messages are delivered to and from a mailbox. Individual users create a profile when they run the Inbox Setup wizard for the first time. Other profiles can be added after running the wizard. The process of creating a profile is invisible to all but advanced users or network administrators.

With Microsoft Exchange profiles, several users, each with an individual set of preferences, can share the same computer to send and receive mail. A single user can also switch between profiles, for example, between one for the office and one for a remote site. If a user is connected to multiple service providers, a profile securely stores any required passwords, allowing the user to log on to multiple mail systems with one password.

The following illustration shows four profiles for three people sharing the same computer. One person has two profiles — one for use on the road and one for the office.

Ann (Work)	Ann (Road)	Mary	Bob
Microsoft Mail Mailbox=Ann Password=x Server=\\y\data Conn=LAN	Microsoft Mail Mailbox=Ann Password=x Server=\\y\data Conn=RAS MSFAX Port=COM1: Modem=USR	Microsoft Mail Mailbox=Mary Password=y Server=\\s\data Conn=LAN	Exchange Mailbox=Bob Password=z Server=\\s



To add a profile in the Microsoft Exchange client

1. In Control Panel, click the Mail And Fax icon, and then click Show Profiles.
2. In the Microsoft Exchange Profiles dialog box, click Add. This starts the Inbox Setup wizard, which leads you through the steps for creating a profile.

Users who share a computer, or who have multiple profiles, can select the profile to use when starting Windows 95.



To choose which profile to use at startup

1. From the Tools menu in the Microsoft Exchange client, click Options.

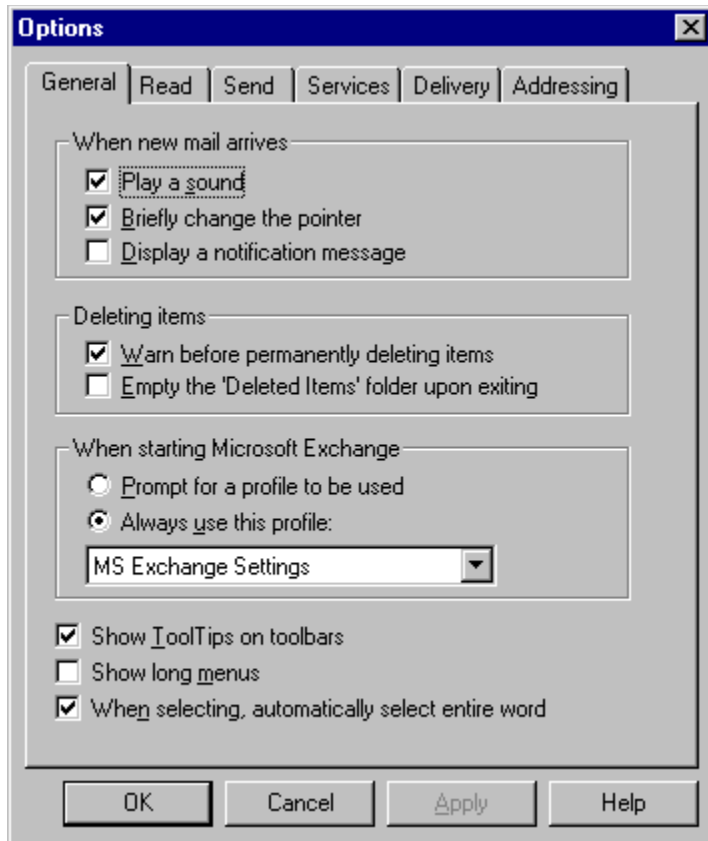

2. In General properties, click the option named Prompt For A Profile To Be Used if you want to choose a profile each time you start Microsoft Exchange.
3. Click the option named Always Use This Profile if you want to specify a default profile.

Note To switch between profiles when running Microsoft Exchange, you must quit Microsoft Exchange and then choose a new profile when restarting.

Using the Microsoft Exchange Client with Microsoft Mail

This section describes how to set up a Microsoft Mail workgroup postoffice to run with the Microsoft Exchange client. The first time you start Microsoft Exchange, you must specify the location of your postoffice. If you have not yet set up a postoffice, you cannot fully configure the Microsoft Exchange client. Consequently, you should set up a Microsoft Mail workgroup postoffice before you run the Microsoft Exchange client.

Electronic Mail and Microsoft Exchange

Using the Microsoft Exchange Client with Microsoft Mail

Upgrading from Windows For Workgroups

If you install Windows 95 in the directory formerly used by Windows or Windows for Workgroups, the Microsoft Exchange client automatically upgrades the Windows for Workgroups Mail or the Microsoft Mail 3.2 Windows client to the Windows 95 Microsoft Mail workgroup postoffice. Microsoft Exchange reads any existing MSMAIL.INI file to determine where to locate the Personal Folder (.PST) and the Personal Address Book (.PAB) files. In addition, the Microsoft Exchange client automatically converts the primary .MMF file to .PST format, so that the Microsoft Mail workgroup postoffice can read it. To convert any additional .MMF files, use the Import Mail Data option in the File menu, as described in [Personal Folder Files](#).

If you upgraded from Windows for Workgroups to Windows 95, the Microsoft Exchange client retains your workgroup postoffice for use with Windows 95. The mail postoffices for Windows for Workgroups and for Windows 95 are identical, so any users using Windows for Workgroups can still share the postoffice. The Windows 95 Microsoft Mail workgroup postoffice cannot exchange messages with other Microsoft Mail workgroup postoffices. To do this, you must upgrade the postoffice to a Microsoft Mail Server postoffice, as described in [Upgrading to Microsoft Mail Server](#).

Setting Up a Microsoft Mail Workgroup Postoffice

Setting up a Microsoft Mail workgroup postoffice consists of the following tasks:

- Deciding the location for the postoffice
- Deciding who will administer the postoffice
- Adding users and user information, such as office locations and passwords
- Sharing the postoffice with all users in the workgroup



To set up a Microsoft Mail Workgroup Postoffice

1. In Control Panel, click the Microsoft Mail Postoffice icon.
2. In the Microsoft Workgroup Postoffice Admin dialog box, click Create A New Workgroup Postoffice, and then click Next.

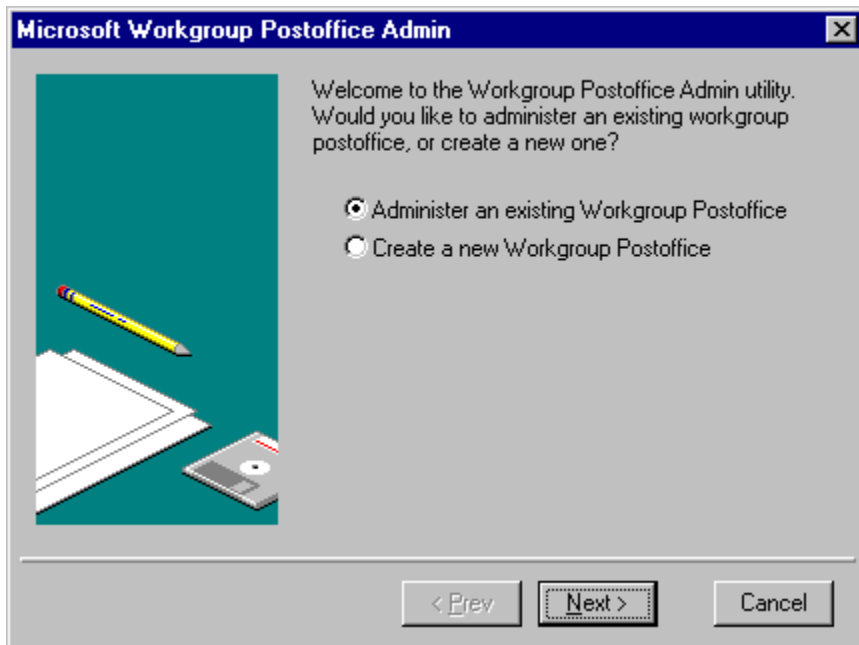

3. Specify where you want the workgroup postoffice to be located, and then Click Next.
4. In the Administrator Account Details dialog box, type information about the postoffice administrator, including name and mailbox name, and a password to restrict administration of the postoffice to the administrator. Click Next to finish creating the postoffice.

Enter Your Administrator Account Details

Name: Jane Doe

Mailbox: JDOE

Password: PASSWORD

Phone #1:

Phone #2:

Office:

Department:

Notes:

OK Cancel

Important Create only one postoffice for your workgroup, or your users will not be able to send mail to each other.

The Microsoft Workgroup Postoffice Admin wizard also allows you to manage the postoffice in the following ways:

- Add users to the postoffice
- Change user information, including replacing forgotten passwords

The workgroup postoffice manager library, WGPOADMN.DLL, is the software component that supports administrative functions such as adding or deleting users and changing passwords.



To administer a postoffice

1. In Control Panel, click the Microsoft Mail Postoffice icon, and then click Administer An Existing Workgroup Postoffice.
2. In the space provided, type the password assigned to the administrator during setup of the postoffice, and then click Next.
3. To add users to your postoffice, click Add User. To change user information, such as a telephone number or a password, select a name from the list box, and then click Details.

Add User

Name: John Doe

Mailbox: Jdoe

Password: Generic

Phone #1:

Phone #2:

Office:

Department:

Notes:

OK Cancel

To allow users within a workgroup to access the Microsoft Mail workgroup postoffice, you must share the directory where the postoffice resides. You can share the directory through Windows Explorer in the same way you share other resources.



To share a Microsoft Mail workgroup postoffice

1. In Windows Explorer, right-click the folder for your workgroup postoffice.
2. From the File menu, click Properties, and then click the Sharing tab.
3. In the Sharing folder, click Shared As and verify the name of the postoffice in the Share Name field. You can also add a comment in the Comment field. Other people will see the comment when they look at a list of computers on the network.
4. Under Access Type in the Sharing folder, be sure to click Full Access if you want all users in your workgroup to access the postoffice.

-Or -

To restrict access to the postoffice by requiring a password, click Depends On Password, and then type a password in the Full-Access Password field.

For information about user-level security, see [Security](#).

When you configure Microsoft Mail using the Inbox Setup wizard, the wizard prompts you for a password. You can then specify whether the Microsoft Exchange client should save the password and automatically enter it when you start mail. This means that someone else using your computer can access your mail. You can change your mailbox password and require that Microsoft Mail ask for your password each time you log on to Windows 95.



To change your mailbox password in the Microsoft Exchange client

1. From the Tools menu, point to Microsoft Mail Tools, and then click Change Mailbox Password.
2. In the Change Mailbox Password dialog box, type the old and new passwords, and then verify the new password. Then click OK.

Note The preceding procedure is for users to change their mailbox passwords on the built-in Microsoft Mail workgroup postoffice. If you are using the Microsoft Exchange client with another electronic mail system, the exact procedure will vary.



To require that Microsoft Mail prompt you for a password

1. In Control Panel, double-click the Mail And Fax icon.
2. In Services properties, double-click Microsoft Mail.
3. In Microsoft Mail properties, click the Logon tab.
4. In the Logon dialog box, make sure the option named When Logging On, Automatically Enter Password is cleared.

Postoffice Directory Structure

A Microsoft Mail workgroup postoffice temporarily stores a message until a user retrieves it. It stores only one copy of each mail message, even when a message is addressed to multiple recipients. When sent to multiple recipients, a message has a reference count in it, which is decremented each time a recipient retrieves the message. The message itself is removed when the reference count drops to 0.

All subdirectories within the Microsoft Mail database must be present for it to function correctly. The following table lists the subdirectories and describes their purpose.

WGPO

Subdirector Description

y

ATT	Encrypted file attachments.
CAL	Microsoft Schedule+ calendar files.
FOLDERS	Public and private folders (with a filename extension of .FLD) for use by MS-DOS workstations. (Folders on Windows for Workgroups workstations are located in their .MMF files on the workstations.) Notice that public folders are created in this subdirectory, but the Microsoft Exchange client cannot view their contents.
GLB	Global system files for Microsoft Mail. These files contain local user logon information and control files to generate mail files.
HLP	Help files.
INF	Postoffice-defined templates. INF contains information files and
TPL	TPL contains templates. ADMIN.INF and ADMIN.TPL contain template information for local postoffice users.
KEY	Index files that contain pointers to header records in the mailbag (.MBG) files.
MAI	Mail messages stored in encrypted form until the recipients' workstations retrieve them.
MBG	Mail headers that point to the mail (.MAI) files. For each file in this directory, there is a matching index (.KEY) file.
MEM	A list of the workgroup postoffice's members.
MMF	Mail message files.
NME	Pointer files for the name alias address lists. ADMIN.NME and ADMINSHD.NME list members of the postoffice address list.
P1	Temporary storage for external programs.
GRP	Settings for multiple postoffice configurations. These
LOG	subdirectories are useful only if you upgrade to the Microsoft
USR	Mail Server. In that case, USR is used to list user names and
XTN	group names for the other network, and XTN is used to list other external information. LOG contains output log files. GRP contains public and private group pointer files.

Setting Up Microsoft Mail on Other Network Servers

You can connect computers running Windows 95 and Microsoft Exchange to a Microsoft Mail workgroup postoffice located on a Windows NT 3.5 server, Novell NetWare server, or any other

independent network file server. Setting up a Microsoft Mail workgroup postoffice on a Windows NT or Novell NetWare server is identical to setting up such a postoffice to work with Windows for Workgroups. If you want to create the WGPO on a Windows NT network server, see *Microsoft Windows NT Server 3.5 System Guide*.

Accessing a Microsoft Mail Workgroup Postoffice Remotely

With the Microsoft Exchange client and Microsoft Mail workgroup postoffice, you can send and receive mail while working away from the office. While offline, you can compose or reply to mail, and then using a modem, telephone line, and Dial-Up Networking, you can establish a remote connection to your organization's network or to your computer, and send and receive mail.

Remote preview of mail.

After you dial in to the network, you can use Microsoft Mail to preview just the headers of new mail messages. That is, you can see who has sent you a message, the subject of the message, the size of the message, and the estimated time it will take to download it. This saves you time and disk space by allowing you not to download unnecessary files. You can also use remote mail when connected to Microsoft Mail on the LAN.

Selective download.

After you retrieve headers, you can mark messages to download or to delete. You can stay on the line after retrieving headers, or call later to download selected messages.

Dial-Up Networking.

The Microsoft Exchange client relies on Dial-Up Networking to connect remotely to postoffices. Because Windows 95 supports the TCP/IP, IPX/SPX, and NetBEUI protocols, you can use Dial-Up Networking to dial into many types of remote access servers to access your postoffice. For information, see [Dial-Up Networking and Mobile Computing](#).

Offline use.

You can compose and address mail offline, that is, while disconnected from a network. Messages are queued up in the Microsoft Exchange outbox until the next time you connect. You can also download a copy of the Microsoft Mail Post Office Address List onto a portable computer for addressing messages when working at a remote site.

Scheduled connections.

You can dial in as needed to retrieve mail remotely, or you can set up scheduled connections to dial in at a specific time or at regular intervals.

Modem sharing through TAPI.

Microsoft Exchange uses the Windows 95 telephony applications programming interface (TAPI) to dial and retrieve mail remotely. TAPI allows applications to share a modem by arbitrating modem requests among applications. For example, configuring a modem to receive incoming faxes does not prevent you making a call to download mail. Microsoft Exchange also uses the TAPI Dialing Properties tool to handle multiple locations, hotel dialing prefixes, and credit card calls. For more information, see [Modems and Communications Tools](#).

Configuring Microsoft Mail for Remote Access

This section describes how to configure the Microsoft Mail workgroup postoffice for remotely accessing the network. Other mail applications might also allow remote access; however, the configuration procedures will differ.

Before you configure Microsoft Mail for remote access, you need to do following:

- Install Dial-Up Networking.
- Install a modem.
- Configure the server on which the postoffice resides for remote access.

To configure Microsoft Mail for remote access, you need to do the following:

- Define a Dial-Up Networking connection to that postoffice. The Dial-Up Networking New Connection wizard is launched when you define a new connection.

You can set the following remote access features in Microsoft Mail properties:

- Whether you want remote preview of mail messages
- When you want to initiate and terminate a remote session
- Whether you want to schedule an automatic connection time
- Whether you want to remotely connect to a postoffice with a modem on startup



To configure Microsoft Mail for remote access

1. In Control Panel, double-click the Mail And Fax icon, click Microsoft Mail, and then click Properties.

-Or -

From the Tools menu in Microsoft Exchange, click Services. In the Services dialog box, click Microsoft Mail, and then click Properties.

2. In Microsoft Mail properties, click the Dial-Up Networking tab and specify a Dial-Up Networking connection for a remote access session. To define a new connection, click Add Entry. The Dial-Up Networking New Connection wizard prompts you for the necessary information.

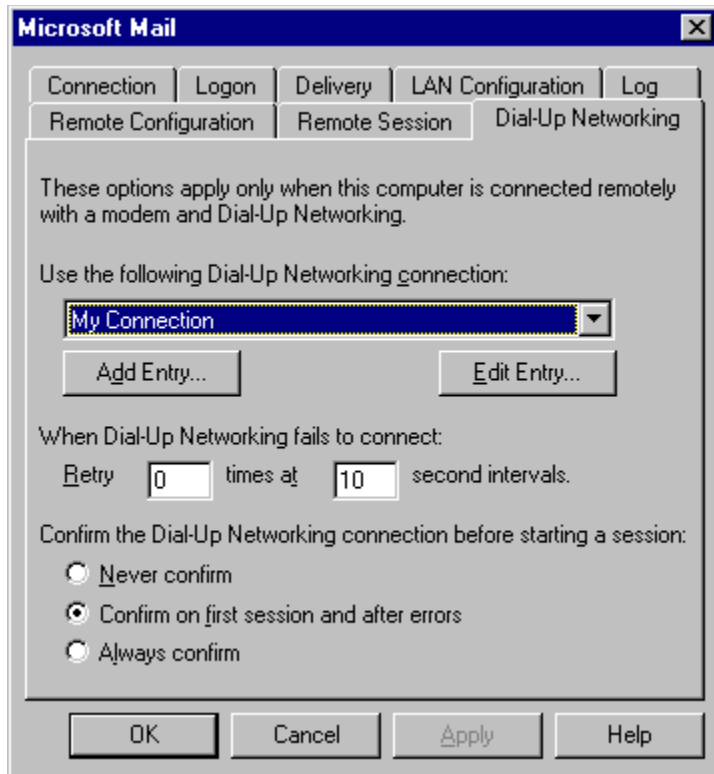

3. In Microsoft Mail properties, click Connection, and then click the option named Remote Using A Modem And Dial-Up Networking.

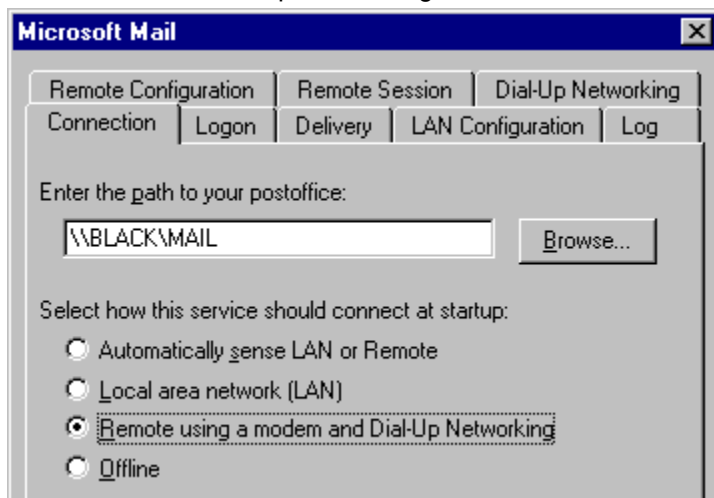

If you click the option named Automatically Sense LAN or Remote, Microsoft Mail queries the system to determine whether it should connect by using LAN or Dial-Up Networking.

If you want to work offline to compose or read mail messages before or after making a remote connecting, click Offline. This step should usually be done after logging on to Windows 95.

4. In Microsoft Mail properties, click the Remote Configuration tab. The option named Use Remote Mail option is selected by default. If you clear this option, Microsoft Mail automatically downloads mail after you have connected.

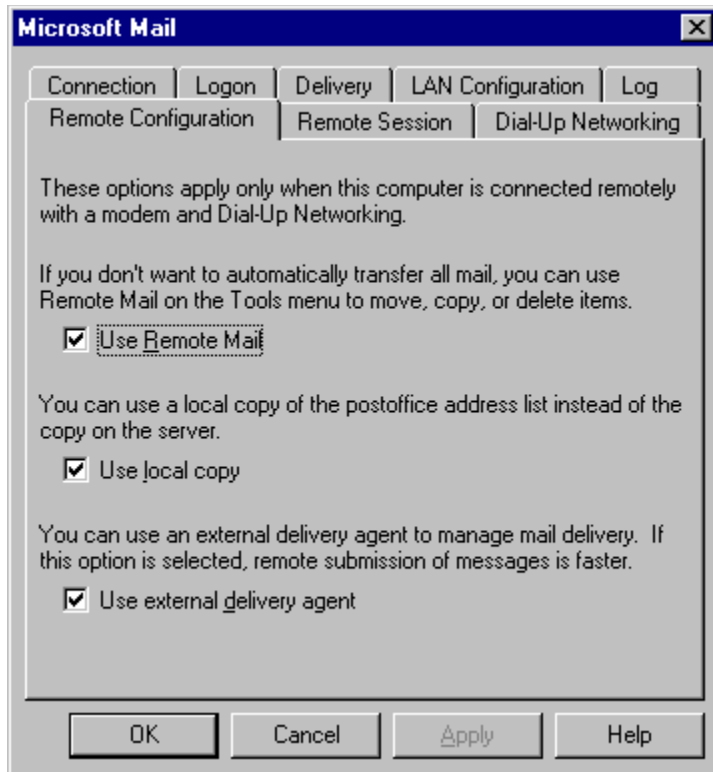

5. In Microsoft Mail properties, click the Remote Session tab and specify whether you want a remote session to start and end when you open and close Microsoft Mail, or to do so under other conditions.

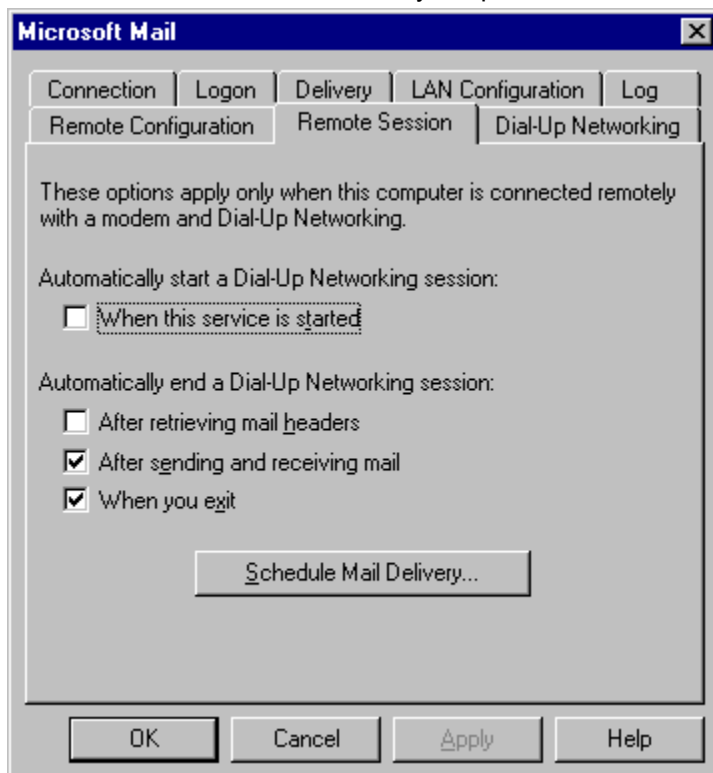

Defining Scheduled Sessions

You can schedule a remote session with Microsoft Mail by specifying a time and connection method. The scheduled sessions are stored in the Microsoft Exchange profile. You can specify up to 16 scheduled sessions, including the following:

- Sessions at a specific date and time
- Sessions at prescribed intervals
- Sessions at specific times on specific days of the week



To define a scheduled session

1. In Microsoft Mail properties, click the Remote Session tab, and then click the Schedule Item Delivery button.

-Or -

In the Tools menu in Microsoft Exchange, click Microsoft Mail, and then click Schedule Remote Mail Delivery.

2. In the Remote Scheduled Sessions dialog box, click Add.

3. In the Add Scheduled Session dialog box, click the Dial-Up Networking connection you want to use to establish the remote connection, and then specify the time for a scheduled session. If you choose Every, then you must specify a prescribed time interval.

Notice that if you click Weekly On, the dialog box contents change so you can specify a date and time.

Electronic Mail and Microsoft Exchange

Accessing a Microsoft Mail Workgroup Postoffice Remotely

Selecting Messages to Download

After you review headers for mail messages in remote mail, you can mark messages for selective downloading.



To mark messages in the Microsoft Exchange client

1. In the Tools menu, click Remote Mail, and then click Microsoft Mail. You can also click other service providers if you have added them to Microsoft Exchange.
2. In the Remote Mail For Microsoft Mail dialog box, click the messages you want to preview.
3. Click the Edit menu, and then click Mark To Retrieve.

Technical Notes on the Microsoft Exchange Client and MAPI

The Windows 95 messaging subsystem architecture provides power and flexibility. The core of the subsystem is MAPI, an industry standard that enables applications in Windows 95 to interact with many different messaging systems using a single interface. The MAPI architecture defines messaging clients, such as Microsoft Exchange, that interact with various messaging service providers, such as Microsoft Mail and Microsoft Fax, through MAPI, as shown in the following diagram:

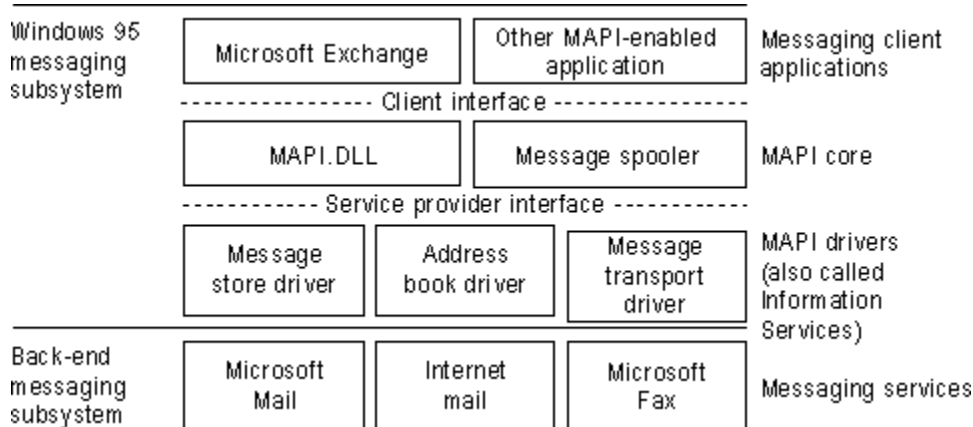

MAPI divides messaging applications into four components: MAPI subsystem, messaging clients, messaging service providers, and messaging systems.

MAPI subsystem.

Messaging client applications communicate with service providers through the MAPI subsystem. The client interface interacts with the MAPI subsystem to access MAPI-compliant service providers.

The client interface is one of two major functional interfaces in MAPI; the other is the service provider interface. Messaging applications that require messaging services call functions in the client interface. For example, client applications can call MAPI functions to send, receive, save, and read messages. These functions are sent to the MAPI subsystem, which calls corresponding functions within the provider interface. Service providers then implement service-provider functions to perform the indicated actions for the client. The message spooler queues outgoing messages and routes incoming messages to the proper message store folder.

Messaging clients.

Messaging client applications communicate with MAPI service providers through MAPI interfaces. Messaging client applications can be divided into three general categories:

- Messaging-aware applications include messaging functions as an added but not required feature, supporting the application's main purpose. An example of a messaging-aware application is Microsoft Word, which can add messaging functions by adding a Send Message command to its File menu.
- Messaging-enabled applications require some form of messaging functionality in order to meet the application's main purpose. Examples of messaging-enabled applications are the Microsoft Exchange client, Microsoft Mail, and cc:Mail™.
- Messaging-based workgroup applications go beyond basic electronic mail. They require full access to all the messaging services, including the message store providers, address book providers, and transport providers. Examples of this type of application are Microsoft Schedule+ and the public folders on a Microsoft Exchange Server.

For information about creating a messaging client, see the *Win32 Software Development Kit for Windows 95 and Windows NT* and the *MAPI 1.0 Developer's Guide*.

Messaging service providers.

A messaging service provider can include multiple message stores, address books, and messaging transport providers.

- Message store providers supply message storage, organization, and retrieval facilities for a messaging system.
- Address book providers supply message addressing and distribution list facilities to the messaging client.
- Messaging transport providers move messages between messaging clients or messaging stores.

MAPI selects between message store and messaging transport providers, as necessary, and merges the address books presented to it, so the client application sees one combined address book interface. Other vendors can add or replace messaging service providers to enable the Microsoft Exchange client to work with their mail systems.

Upgrading to Microsoft Mail Server

You can upgrade your Windows 95 postoffice to a full Microsoft Mail Server postoffice by using the Microsoft Mail Post Office Upgrade product, which includes software, documentation, and licensing to extend the connectivity of your workgroup. The Microsoft Mail Server postoffice provides the following additional features:

- Executable and Help files that are not available in the Windows 95 Microsoft Mail workgroup postoffice
- Postoffice support for connections to external postoffices or gateways
- An ADMIN account not created in Windows 95 mail
- Default ADMIN.TPL and ADMIN.INF files created in Microsoft Mail Server for adding the predefined extended user information in the workgroup postoffice structure
- An administration utility (ADMIN.EXE) used to manage and configure the postoffice from any workstation on the network
- Support files for external postoffice mail transfer through a network or modem
- A routing program, EXTERNAL.EXE, that routes mail between multiple postoffices and gateways
- Client software for Windows 3.1, MS-DOS, and Apple® Macintosh® operating systems

The *Microsoft Mail Post Office Upgrade* product includes the following components:

- Software to upgrade a workgroup postoffice to a full Microsoft Mail Server postoffice
- Advanced administration tools, including tools for routing, directory synchronization, network group names, user access privileges, and mail log files, and for deleting old mail and old Mail accounts
- The EXTERNAL.EXE component, which provides the process for connecting postoffices (by means of a physical or asynchronous link) with the platform for remote access
- Client software for Windows 3.1, MS-DOS, Macintosh, and IBM® OS/2® Mail.

If you want to set up a Windows 95 Microsoft Mail workgroup postoffice to route mail between two or more postoffices, you need to do the following:

- Purchase the Microsoft Mail Post Office Upgrade for each workgroup postoffice being connected, and then follow the directions provided in the product.
- Set up a dedicated MS-DOS-based computer to act as the router. It will be running the EXTERNAL.EXE program included in the Post Office Upgrade. Notice that this MS-DOS-based computer needs networking software to connect to your postoffice servers. If the postoffices are stored on computers running Windows 95, then this computer needs a copy of Microsoft Workgroup Add-on for MS-DOS. If your postoffices are on Novell NetWare servers, then the computer running MS-DOS needs Novell client software for MS-DOS.
- If the postoffices are not on the same LAN, you need a dedicated MS-DOS-based computer to run EXTERNAL.EXE at each site, plus a modem for communicating with the other sites. Notice that Microsoft also offers versions of EXTERNAL.EXE that run on IBM OS/2 or Windows NT servers.

Upgrading to Microsoft Exchange Server

A next-generation client-server messaging system known as Microsoft Exchange Server will be available from Microsoft after the release of Windows 95. Microsoft Exchange Server provides advanced electronic mail, scheduling, groupware applications, and custom application development. Microsoft Exchange Server includes MAPI drivers that extend the capabilities of the Windows 95 Microsoft Exchange client. For example, when Microsoft Exchange is connected to an Exchange Server, you can access a replicated "public folder," create custom forms and shared documents, schedule meetings with others, manage time and tasks, and create custom electronic forms for use in business.

Microsoft Exchange Server will require a computer running Windows NT Server version 3.5 or higher. It also includes a built-in X.400 gateway, plus support for SMTP and for Microsoft Mail for Intel® and Apple Macintosh computers. For more information about Microsoft Exchange Server, contact your Microsoft sales representative.

Microsoft Mail Gateways

Many large organizations have multiple electronic messaging systems. In your organization, you might need to communicate with workgroups or organizations using electronic mail systems other than Windows 95 mail, such as cc:Mail, HP® Openmail, or IBM PROFS®. Microsoft offers a complete line of advanced gateways that provide reliable and sophisticated connectivity between Microsoft Mail Server and virtually any other electronic mail system within your organization.

Gateways ensure that messages always get across to their intended recipients. Addressing messages remains an easy process because people using other mail systems will be listed in your Microsoft Mail global address list — all you need to know is the name of the person you need to communicate with.

Microsoft offers gateways for the following:

X.400	IBM PROFS	SNADS
SMTP	MHS	AT&T Easylink™
MCI MAIL	Fax	

Note Microsoft Exchange Server will provide built-in support for X.400 and Internet Mail (SMTP). Users who upgrade to Microsoft Exchange Server will not need to purchase gateways for X.400 or SMTP.

Microsoft gateways support key features such as messaging backboning and message encapsulation.

- Messaging backboning lets organizations leverage their existing messaging resources by using these systems as high-performance bridges — or messaging backbones — between multiple Microsoft Mail sites.
- Message encapsulation makes it possible for users to place graphics, charts, sound, and video objects directly in mail messages for richer communication. Moreover, these complex messages can be sent across messaging backbones between distant sites without any loss of data integrity.

To connect a workgroup postoffice to another workgroup postoffice, you must purchase Microsoft Mail Postoffice Upgrade for each postoffice. To connect to another message system, such as X.400 or SMTP, you'll need to install both Microsoft Mail Postoffice Upgrade plus the appropriate gateway software.

Note You will need at least one dedicated computer to act as the mail router, or the EXTERNAL.EXE program. Some gateways might require additional dedicated computers to connect to host systems. Before proceeding, you should determine your requirements by obtaining gateway datasheets.

Each message system can connect to the workgroup postoffice by using one or more specific gateways. The following table is a partial list of the Microsoft gateways needed for various message systems. If you use one of the message systems listed in this table, you need to purchase the appropriate gateway.

Microsoft Mail Gateways for Message Systems

Message system	Microsoft Mail gateway
ARCOM 400 Swiss PTT	X.400
AT&T® Easylink Services	X.400
AT&T Mail	X.400 or AT&T Gateway
Atlas 400	X.400 (NF mark from Afnor)
Banyan® Mail	MHS or X.400
Beyond Mail	MHS
cc:Mail	X.400, MHS, SMTP, or Office Vision
CompuServe	SMTP or MHS

The Coordinator	MHS
Data General® CEO	X.400
DaVinci Systems™	MHS
DEC™ All-In-1™	X.400, PROFS, SNADS, or SMTP
DEC VMS™ Mail	X.400 or SNADS
Dutch PTT	X.400
Envoy 100/Gemdes	X.400
Fax	Fax
Fischer International EMC2	X.400 or SNADS
Gold 400 UK	X.400
Higgins	MHS
IBM AS/400® Office	SNADS ₁
IBM System/36™	PROFS/OV
IBM CMS NOTES	PROFS
IBM DISOSS	SNADS
IBM OfficeVision/MVS™	SNADS ₁
IBM PROFS	PROFS
Computer Sciences Infonet®	X.400
Internet	SMTP
Lotus® Notes®	MHS ₂
Microsoft Mail for AppleTalk®	Microsoft Mail connection
NCR® Corporation	X.400 ₃
Novell NetWare	MHS
Retix®	X.400
Soft-Switch Central	SNADS
Sprint TeleMail	X.400
Telebox 400 German PTT	X.400
Touch	X.400
Unisys®	X.400
UNIX® SMTP	SMTP ₄
UUCP	SMTP ₅
Verimation Memo	SNADS
WANG® Office	MHS, X.400, or PROFS

¹ Or through PROFS Distribution Manager if you have a VM host.

² Or the MS Mail-Notes Gateway by Corporate Software.

³ Or in some cases, the AT&T Gateway

⁴ SMTP is a part of TCP/IP, not UNIX. You can also have SMTP origination to a VAX or IBM host.

⁵ Requires connectivity to an SMTP host that acts as a router to UUCP.

Electronic Mail and Microsoft Exchange

Microsoft Mail Gateways

Microsoft Gateway to Fax

Using Microsoft Gateway to Fax, you can send several types of items — such as electronic mail messages, text files, and graphic attachments — in a single fax. You can use this product to transmit attachments in any of three different formats: ASCII (text), black and white .PCX, or .DCX (graphics).

Microsoft Gateway to Fax includes the following features:

- Ability to view incoming fax messages, scaling them to one-eighth of their full-sized view, and rotating pages 90 or 180 degrees.
- Easy setup and administration.
- Improved error reporting and support for the high performance GammaFax board, in addition to the Intel® SatisFAXtion® and Connection Coprocessor boards.
- Verification of file type attachments before transmitting outgoing faxes, ensuring their format is supported by the fax board (ASCII, .PCX, or .DCX). If not, the message is returned to the sender.

Microsoft Mail Gateway to MHS

MHS is a messaging system commonly found in Novell NetWare networks. With Microsoft Mail Gateway to MHS, users can route mail between Microsoft Mail workgroup postoffices and sites using MHS. Encapsulation technology preserves the following across the MHS backbone:

- Address information
- OLE objects
- Binary file attachments

The Microsoft Mail Gateway to MHS includes the following features:

- Address mail routed to MHS mail users in a familiar Microsoft Mail format.
- Add individual MHS users to the Microsoft Mail Personal Address Book.
- Send or receive an unlimited number of attachments in one message and the attachments can be any type of text or binary files.
- Address MHS users and add them to personal address lists without calling on system administration resources.
- Support error logging for MHS activity.
- Provide compatibility with most popular MHS mail systems, including Da Vinci Systems Mail version 1.8, The Coordinator version II, Lotus® cc:Mail version 3.2, and any fully MHS 1.5-compatible system, such as Novell Global Messaging.

Microsoft Mail Gateway to X.400

Microsoft Mail Gateway to X.400 offers transparent backboning using an X.400 network. It links geographically dispersed local area networks into a single mail network. It connects local area networks, mainframes, minicomputers, and microcomputers with X.400. This gateway uses the X.400 gateway to connect to an unlimited number of message transfer agents (MTAs) and functions as a relay between them. This gateway also provides X.400 over an 802.x LAN.

Microsoft Mail Gateway to X.400 includes the following features:

- Provides OSI LAN connectivity, eliminating the need for costly additional software, hardware, or communications lines.
- Supports multiple simultaneous active sessions for higher overall throughput and accepts up to two incoming calls while sending a message.
- Accepts local area and wide area network connections simultaneously for more flexibility.
- Uses encapsulation, or “tunneling,” to exchange messages containing text, multimedia objects, binary files, and directories with other Microsoft Mail users across X.400 backbones without losing information or data integrity.
- Provides easy configuration and maintenance with a new full-screen utility, which administrators can use to view and print log files and configuration parameters.
- Assign users arbitrarily — even multiple X.400 addresses — without shutting down the gateway with Advanced Address Mapping.
- Adds a new address simply by filling out the address template provided. Reads friendly names on mail from other X.400 systems instead of lengthy X.400 O/R addresses. X.400 addresses can be added to the Microsoft Personal Address Book.

Microsoft Mail Gateway to X.400 complies with international X.400 standards in the following ways:

- Acts as a fully functional CCITT 1984 X.400 MTA and being able to communicate with 1988-compliant MTAs
- Supports NIST, ENV 41202 (A/311) X.400 profiles
- Conforms to OSTC
- Has Afnor Certification

The gateway offers the following bodypart support:

- Supports bodypart 0 (IA5), including translation tables for Norwegian, German, and Swedish, in addition to standard International Reference Version (IRV) for improved interoperability between European X.400 systems.
- Supports bodypart 5 (T.61/Teletex) for extended character support.
- Includes new bodypart 13 support (ISO 6937) to seamlessly carry text in attached files with accented characters not supported through the standard IA5 text character set.
- Supports binary attachments using bodypart 14, so attachments can be sent to other systems without losing any information.

Electronic Mail and Microsoft Exchange

Microsoft Mail Gateways

Microsoft Mail Gateway to SMTP

With Microsoft Mail Gateway to SMTP, users can send and receive Simple Mail Transfer Protocol (SMTP) messages as easily as Microsoft Mail.

This gateway is easy to maintain. Administrators can use the standard Microsoft Mail administration program to control access to the gateway and to use the full-traffic and error-logging support to isolate problems and optimize routing. Global directory synchronization provided by the product can reduce directory maintenance by automatically updating Microsoft Mail directories with user addresses from other electronic mail systems in the organization.

You can link Microsoft Mail systems transparently using SMTP. Encapsulation lets users send mail messages containing text, binary files, multimedia objects, and directory updates over a messaging backbone without any loss of data integrity. This gateway automatically encapsulates all binary file attachments and messages with extended characters.

Microsoft Mail Gateway to SMTP supports the following major standards:

- TCP/IP
- RFC 821 SMTP
- RFC 822 ARPA Internet Text Messaging Standard
- RFC 1154 Encoding Header Field for Internet Messages
- Incoming and outgoing encapsulated attachments

Microsoft Mail IBM PROFS and OfficeVision Gateway

With this gateway, PROFS and OfficeVision users send mail to Microsoft Mail users using standard PROFS and OfficeVision or CMS NOTE addressing formats. Users on PROFS and OfficeVision systems can respond to a message from either system using the Reply option and receive automatic acknowledgment of registered mail delivery.

Microsoft Mail IBM PROFS and OfficeVision Gateway includes the following features:

- Flexible and reliable architecture to improve connectivity. A mainframe component creates a virtual machine (VM) and identifier for the Remote Spooling Communication Subsystem (RSCS). A standard Network Job Entry (NJE) RSCS link connects Mail to the VM. Multiple LANs can be connected to single or multiple VM nodes.
- Transparent exchange of scheduling information. When PROFS and OfficeVision users receive meeting requests or meeting notes from Microsoft Schedule+, they appear as familiar PROFS and OfficeVision meeting requests and vice versa. Free and busy times of PROFS and OfficeVision users can be periodically downloaded to the LAN for scheduling purposes.
- Extensive file support between systems to help mainframe and personal computer users work together more effectively. VM users can send files to Microsoft Mail users using SENDFILE, DISK DUMP, PUNCH, and PRINT formats. In addition, Microsoft Mail attachments appear as files in the VM user's Virtual READER.
- Generic Routing Facility (GRF) to make the gateway easy to administer and troubleshoot. All Microsoft Mail users appear to PROFS and OfficeVision users as if they are on a single VM node. (The ability to define a VM node per Microsoft Mail workgroup postoffice still exists, even if GRF is being used.) Using message size restrictions, administrators can limit the size of messages transmitted.
- Distribution Manager adds document-exchange features and links Microsoft Mail to a variety of host systems. It offers the ability to exchange messages and documents with other messaging systems that use the Document Interchange Architecture (ZIP packet protocol), such as OfficeVision/MVS, OfficeVision/400™, PS/CICS, System/36, remote PROFS and OfficeVision using DISOSS, and (through gateways) DEC® All-In-1, WANG Office, and Verimation Memo.

Microsoft Fax

Introduction

This chapter describes how to use Microsoft Fax software to send and receive faxes and editable files (files that can be changed) from your computer.

- Microsoft Fax: The Basics
- Microsoft Fax: The Issues
- Overview of Microsoft Fax
- Setting Up Microsoft Fax for the User
- Sending Faxes
- Retrieving Faxes
- Network Fax Service
- Security for Microsoft Fax
 - Establishing Security and Exchanging Keys
 - Sending Secured Faxes
- Technical Notes for Microsoft Fax

Microsoft Fax: The Basics

With Microsoft Fax, users with modems can exchange faxes and editable files as easily as printing a document or sending an electronic mail message. Microsoft Fax is compatible with the millions of traditional Group 3 fax machines worldwide, yet it provides advanced security and binary file transfer (BFT) features that make sharing information by means of a fax easier and more powerful.

To use Microsoft Fax, you must install Microsoft Exchange. Microsoft Fax has been integrated into Microsoft Exchange as a messaging application programming interface (MAPI) service provider. All faxes sent to Microsoft Fax are received in the Microsoft Exchange universal inbox. You can send a fax by composing a Microsoft Exchange message, or by using the Send option on the File menu of a MAPI-compatible application (such as Microsoft Excel or Microsoft Word). In addition, Microsoft Fax includes a fax printer driver so that users can "print to fax" from within any Windows-based application.

Microsoft Fax provides the following key features.

Fax at your fingertips.

With Microsoft Fax, sending traditional faxes to Group 3 fax machines is as easy as printing a document. Additionally, Microsoft Fax uses the highest transmission speed and image compression supported by the recipient fax machine. Faxes sent in this way cannot be edited by the recipient.

Delivery by address type.

The MAPI service provider architecture allows you to mix different types of recipients in the *same* message. For example, it is possible to send a message simultaneously to Microsoft Mail, CompuServe®, Internet, and Microsoft Fax users as long as profiles for these destinations have been defined within Microsoft Exchange. A recipient's fax address can be selected from the Microsoft Exchange Personal Address Book, or the fax can be addressed by using an address that you use just once such as [fax: 555-1212].

Binary file transfer (BFT).

Microsoft Fax supports Microsoft At Work BFT, which makes it possible to attach an editable document to a Microsoft Exchange mail message. These editable documents can be sent to users of Windows 95, Windows for Workgroups 3.11, and other Microsoft At Work™-enabled platforms.

Security.

Microsoft Fax lets you securely exchange confidential documents by using public key encryption or digital signatures. Any security specified by the user is applied before the message is passed to the modem or connected fax device.

Network fax service.

You can install a fax device in one computer and share it with other users within a workgroup. Individual computers can have their own fax devices installed and still use the shared fax device.

Microsoft Fax Viewer.

The Microsoft Fax Viewer displays outgoing fax messages that have been queued to a local fax modem or to a Microsoft Fax network fax service. The Fax Viewer provides information about the current set of messages that are queued for transmission. You can also browse multipage faxes in thumbnail or full-page views.

"Best available" fax format.

When you make a fax connection in Windows 95, Microsoft Fax queries and exchanges its fax capabilities with the recipient. This exchange of capabilities determines whether the recipient is a traditional Group 3 fax machine, which can only receive rendered faxes, or if the recipient has Microsoft Fax capabilities, and can receive editable files. Windows 95, Windows for Workgroups 3.11, and Microsoft At Work fax platforms are all capable of receiving binary files and traditional faxes.

- If the receiving fax device supports Microsoft Fax capabilities and an editable document is attached to a Microsoft Exchange message, then the file is transferred in its native format, in the same way as electronic mail.
- If the receiving fax device is a traditional Group 3 fax machine, then Microsoft Fax converts the document to the most compressed type of fax supported by the machine (MH, MR or MMR compression type) and transmits the image by using the best available communications protocol

supported by the mutual connection (that is, V.17, V.29 or V.27).

- If Microsoft Fax sends a noneditable fax to another Microsoft Fax user, then the fax is transmitted by using the Microsoft At Work rendered fax format. This special format is much more compressed, on average, than Group 3 MMR. Therefore, the exchange of noneditable faxes between Microsoft Fax users is always faster than between Group 3 fax machines.

Compatibility with popular fax modems.

Microsoft Fax is compatible with Class 1 and Class 2 fax modems, and provides support for high-speed fax communications (V.17, V.29, and V.27).

Custom fax cover pages.

With Microsoft Fax, you can create new fax cover pages with a cover page designer that lets you incorporate graphics and text, or you can customize one of the predefined cover pages included with Microsoft Fax.

Connecting to fax information services.

Microsoft Fax easily connects to fax-on-demand systems by using a built-in, poll-retrieve feature that allows you to retrieve rendered faxes or editable documents from a fax information service.

Microsoft Fax: The Issues

Before you install and configure Microsoft Fax on the network, you will need to decide the following:

- Which users need Microsoft Fax. For every user who needs Microsoft Fax, you must also install Microsoft Exchange. All faxes sent to that user are received in the Microsoft Exchange inbox.
- Whether to install fax modems on individual computers or to designate a computer running Windows 95 to host a Microsoft Fax network fax service for other members of a workgroup.
- Which computer within a workgroup will host the Microsoft Fax network fax service. If the computer will also be used as a workstation, then a 80486-based computer with at least 12 MB of RAM is recommended. If the computer will be a dedicated fax server, then at least 8 MB of RAM is recommended. A high-speed (14.4 kbps) fax modem is strongly recommended. Depending on fax volumes, a shared fax service with this configuration could support up to 25 network fax users.

Note When the computer hosting the shared fax modem receives faxes, Microsoft Fax does not automatically route them to individual inboxes. The workgroup administrator must use Microsoft Exchange to send a received fax to the recipient's Microsoft Exchange inbox.

- Whether you want to control or restrict access to the shared fax service. You can control access by defining a shared fax password, as described in [Network Fax Service](#).
- Whether your workgroup's fax needs might be better served by a LAN fax server or commercial fax service. This depends on whether your organization has high fax volumes and inbound routing requests and as a result needs more detailed cost tracking and management. Microsoft is working with vendors of high-performance fax server platforms to ensure that their products are well-integrated with Windows 95 and Microsoft Fax.
- Whether your fax modems and fax machines are compatible with Microsoft Fax. To ensure connections with the widest variety of fax applications, fax machines, and fax modems, Microsoft Fax supports the following international standards for fax communications:
 - ITU (International Telecommunications Union, formerly the CCITT) T.30 standard for Group 3 fax machines. Microsoft At Work capabilities such as BFT are implemented as T.30 NSF (nonstandard facilities), thereby maintaining compatibility with the installed base of Group 3 fax machines.
 - ITU V.17, V.29 and V.27 standards for high-speed fax communications (up to 14.4 kbps).
 - Class 1 and Class 2 fax modems. A Class 1 fax modem is required for Microsoft At Work BFT and security. Fax rendering to traditional Group 3 fax devices is available on both Class 1 and 2 modems. Microsoft is working directly with fax modem manufacturers to ensure excellent compatibility.
 - MH, MR, and MMR compression for Group 3 fax communications.
 - Microsoft At Work fax platforms.

Overview of Microsoft Fax

Users can easily exchange faxes and binary files in Microsoft Fax because it is accessible from the Windows 95 desktop, from within applications, or through the Microsoft Exchange inbox. As a 32-bit application, Microsoft Fax works smoothly with other applications created for Windows 95 through its support for MAPI, telephony API (TAPI), and OLE. The Send option in the File menu within any MAPI-enabled application (for example, Microsoft Excel or Word) will activate the Microsoft Exchange Send dialog box. The document appears as an icon attached to the electronic mail message.

To configure Microsoft Fax, do the following:

- Install and configure a modem for sending and receiving faxes. For more information, see [Modems and Communications Tools](#).
- Install Microsoft Exchange and Microsoft Fax. The Microsoft Exchange Setup wizard will guide you through the installation procedure.
- Add Microsoft Fax to Microsoft Exchange.

After Microsoft Fax is configured, users can easily exchange rendered faxes and binary files. Because Microsoft Fax is provided with Windows 95 as a basic service, it is always available from within applications created for Windows 95 or through the Microsoft Exchange inbox. Faxes are always received in a user's Microsoft Exchange inbox.

Microsoft Fax

Setting Up Microsoft Fax for the User

The easiest way to install Microsoft Fax is to choose it in the Get Connected dialog box during Windows 95 Setup. You can also install it after you install Windows 95 by using the Add/Remove Programs option in Control Panel.



To install Microsoft Fax after Windows 95 installation

1. In the Add/Remove Programs option in Control Panel, click the Windows Setup tab.
2. In the Components list box, click Microsoft Fax. If you have not previously installed Microsoft Exchange, Windows 95 automatically selects and installs it at this time. Click OK.



To configure Microsoft Fax

1. In Control Panel, double-click the Mail And Fax icon, and then click Add.
-Or -
From the Tools menu in Microsoft Exchange, click Options, click the Services tab, and then click Add.
2. In the Add Services to Profile dialog box, click Microsoft Fax.
3. A Microsoft Fax warning message asks if you want to type your name, fax number, and fax device modem. Click OK.
4. In Microsoft Fax Properties, click the Message, Dialing, Modem, and User tabs, and type the appropriate information.

The screenshot shows the 'Microsoft Fax Properties' dialog box with the 'User' tab selected. The dialog box contains the following fields and information:

- Message** | **Dialing** | **Modem** | **User**
- Icon of a person and a document: The information you enter here may be displayed on the fax cover page and gives the recipient your return fax address
- Your full name: Jane Doe
- Your return fax number:
 - Country: United States of America (1)
 - Fax number: (206) 9999999
 - Mailbox (optional): Jdoe
- Company: Microsoft Corporation | Title: Account Executive
- Address: [Empty field] | Department: Marketing
- Office Location: Building 4
- Home telephone number: 3456789
- Office telephone number: 5678910
- Buttons: OK, Cancel

If you have installed a modem, Windows 95 automatically enters that information in the Modem properties. If you have not installed a modem, or if you want to select a different modem for sending

faxes, click the Add button in the Modem properties to run the Install New Modem wizard.

Note The information you type in User properties automatically appears on the cover page of faxes you send in Microsoft Fax.

After you have configured Microsoft Fax, you can change its properties by clicking the Setup option in the Fax menu in Microsoft Exchange. If you have problems setting up Microsoft Fax, see the troubleshooting information for Microsoft Fax in online Help.

Sending Faxes

You can use Microsoft Fax to send and receive faxes by using a fax modem attached to your computer or on a network. Faxes are mail messages that are sent over the phone lines. Microsoft Fax shares the Personal Address Book with Microsoft Exchange and other MAPI providers.

The only difference between a mail message and a fax, from a Microsoft Exchange user's perspective, is the format of the recipient's address. Each Microsoft Exchange service provider, such as the Microsoft Network or Microsoft Fax, has its own format for a recipient's address.

You can send faxes from within Windows 95 in the following ways:

- Use Microsoft Exchange to create an electronic mail message and fax its contents to a recipient as described in the following procedures. If the message recipient is also using Windows 95, the message can include binary files and editable documents. Otherwise, the message will be rendered and sent as a fax.
- Print a document to the fax printer driver. If you select Microsoft Fax as the target printer for the document, and then click the Print option in the File menu, the Compose New Fax wizard will run.

- Run the Compose New Fax wizard by double-clicking the Fax icon in the Accessories menu.
- Use Windows Explorer to drag and drop a document onto a Microsoft Fax printer icon on the Windows 95 desktop.
- Right-click a document icon in My Computer to display the context menu. In the context menu, select the Send To option, and then select the Fax Recipient option to run the Compose New Fax wizard. The application that created the original document starts so that the document can be rendered (printed). After it is rendered, the application closes.
- Use the Send option in the File menu of a MAPI mail-enabled application such as Microsoft Word or Microsoft Excel to activate Microsoft Exchange.

Note You can create a shortcut to the Microsoft Fax printer by right-clicking the Microsoft Fax printer icon and then dragging it to the Windows 95 desktop.



To send a fax from Microsoft Exchange

1. In the Compose menu, click New Fax to run the Compose New Fax wizard.
2. In the Compose New Fax Wizard dialog box, select the fax recipient's name and number from your

Microsoft Exchange Personal Address Book, or create a new name, and then click Next.

3. Click Yes to include a fax cover page with your message, and then click a type of predefined cover page, or click Options to define a message format and a time to send the fax.
4. In the Next dialog boxes, compose your message and insert any binary files or objects you want to include in the fax.



To send a fax from the Windows 95 Start button

- Point to Programs, and then point to Accessories, point to Fax, and then click Compose New Fax.

With Microsoft Fax, you can attach a cover page to a fax by selecting from four predefined cover pages, or by creating a custom cover page for each recipient. The predefined cover pages are named Urgent!, Confidential!, For Your Information, and General Purpose (default). You can also customize predefined cover pages as described in the following procedure.

With the Microsoft Fax Cover Page Editor, you can also design a unique cover page for each recipient. The Cover Page Editor allows you to incorporate rich text, graphics, logos, and information from the Microsoft Exchange Personal Address Book into a cover page.

Note All cover pages contain recipient information that you first entered in the Microsoft Exchange Personal Address Book. Microsoft Fax inserts this information each time you send a fax.

See the following online Help topics for information about creating cover pages in Microsoft Fax:

- Attaching a predefined cover page to a fax message
- Customizing predefined cover pages
- Creating a custom cover page

Microsoft Fax

Retrieving Faxes

With the Request a Fax option, you can retrieve faxes from fax machines, fax-on-demand systems, and other fax information services that support Group 3 poll-retrieve capability. Some Group 3 fax machines allow you to retrieve editable files, software updates, and fax images by using the Microsoft At Work BFT protocol.

To retrieve faxes, you start the Request A Fax wizard in the Accessories menu or in Microsoft Exchange. The wizard allows you to download a specific document or a default document that includes the names of other available documents on the service.



To retrieve faxes using Request a Fax in Microsoft Exchange

- Click the Tools menu, point to Microsoft Fax Tools, and then click Request A Fax.

The Request a Fax wizard guides you through the steps required to connect to a fax service and download faxes to your computer.

Microsoft Fax

Network Fax Service

With Microsoft Fax, users in the same workgroup can share a fax modem installed on one of the computers in the workgroup. After the fax modem has been shared, all other users within the workgroup can send and receive faxes through it. The computer that contains the shared fax modem is called the fax server.

The Microsoft Exchange inbox of the fax server receives all of the faxes for the workgroup. The administrator for the server uses Microsoft Exchange to route the faxes to their intended recipients in the workgroup. Received faxes appear in the Microsoft Exchange inbox and each one is identified as a fax by a special icon. If the icon represents a rendered fax, double-clicking it runs the Microsoft Fax Viewer application. Otherwise, Microsoft Exchange opens the fax as if it were an electronic mail message. You can forward and reply to faxes in the same way you would a Microsoft Exchange mail message.

Before you configure a computer running Windows 95 as a fax server, make sure it has enough memory and that it has a compatible modem. For memory requirements, see [Microsoft Fax: The Issues](#).



To configure a computer as a fax server in Microsoft Exchange

1. Click the Tools menu, click Microsoft Fax Tools, and then click Options.
2. In the Microsoft Fax Properties dialog box, click the Modem tab.

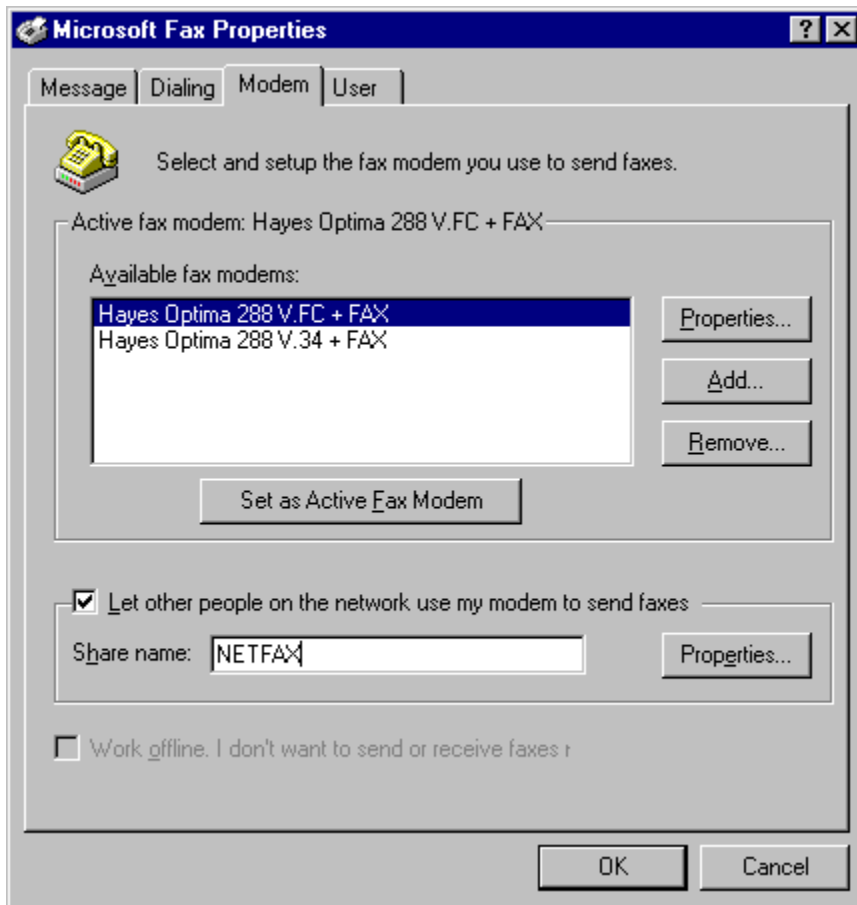

3. In Modem properties, make sure the option named Let Other People On The Network Use My Modem To Send Faxes is checked.
4. To change the Share Name for the shared fax modem, click the Properties button, and then type a new name. By default, Microsoft Fax displays the name of the Network Fax shared directory.

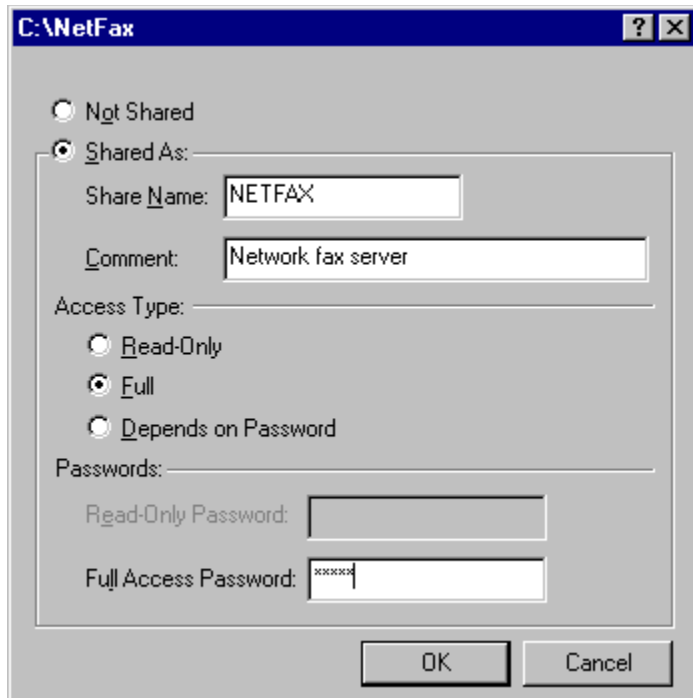

You can also define security in the shared directory's properties. If you have user-level security enabled, you can define which users can have access to the network fax service, and define their access rights. If you have share-level security enabled, you can define whether a password is required to connect to the network fax service. For more information, see [Security](#).

If you choose Full access (the default), all users within the Windows 95 workgroup can send faxes by using the shared fax service.

5. Click OK to enable the Microsoft Fax shared fax server.

Note Other users in the Windows 95 workgroup must know the fax server's full network name to access it. The name is formed by joining the server's computer name (defined in the Network option in Control Panel) with the shared directory name, for example, \\JOELLEN\NETFAX.



To configure a computer as a client to the fax server in Microsoft Exchange

1. Click the Tools menu, click Microsoft Fax Tool, and then click Options.
2. In the Microsoft Fax Properties dialog box, click the Modem tab.
3. In Modem properties, click Add.
4. In the Add a Fax Modem dialog box, click Network Fax Server, and then click OK.
5. In the Connect to Network Fax Server dialog box, type the network name of the fax server and then click OK.
6. In the Microsoft Fax Properties dialog box, click the server name, and then click the Set as Active Fax Device button.

Security for Microsoft Fax

Microsoft Fax protects valuable and confidential documents through encryption and digital signatures. An encrypted fax can be read only by the intended recipient, who has a set of keys to unlock it or a password. A digitally signed fax allows a recipient to verify that the purported sender of the fax is the actual sender. You can use a digital signature on its own or add a digital signature to a fax protected with password or key encryption.

Password and key encryption.

You can encrypt a fax or binary file by using either a simple password or a public or private key pair. Password encryption, which is the simplest security method, scrambles a fax based on a specific password. The fax recipients can only unscramble the fax if they know the password. Password encryption does not require the exchange of public keys with your recipients, but you will need to tell them the password that you used to secure the fax.

When you use key encryption, Microsoft Fax assigns you two security keys, a private key and a public key. You can exchange public keys with anyone you choose. When you send a key-encrypted message, Microsoft Fax uses the recipient's public key and your private key to encrypt the message. When the message is received, Microsoft Fax uses your public key and the recipient's private key to decrypt it. Using your own private key ensures that the message could have been sent only by you. Using the recipient's public key ensures that only the recipient can unlock the message. You can store and maintain the public keys you receive from other users in your Microsoft Exchange Personal Address Book.

Note Microsoft Fax applies security only to those faxes that have been sent as editable files. Rendered faxes cannot be secured.

Digital signatures.

Using a digital signature to secure a fax is similar to notarizing a document; it verifies for the recipient that the person who signed the document is the person who sent it. Digital signatures prevent anyone but the sender from modifying the document while it is being sent.

Digital signatures can only be used with binary file documents, that is, those that have been attached to mail messages (not rendered). Before you can use digital signatures, you must establish security and exchange public keys with a recipient.

Establishing Security and Exchanging Keys

The first step in using key encryption or digital signatures is establishing security.



To establish security in Microsoft Exchange

1. Click the Tools menu, point to Microsoft Fax Tools, and then click Advanced Security.
2. In the Advanced Fax Security dialog box, click the New Key Set button.



3. In the Fax Security - New Key Set dialog box, type a password, and then click OK. This password will be used for sending and receiving both key-encrypted and digitally signed faxes. Microsoft Fax automatically creates a public and private set of keys for you, and then it displays the Advanced Fax Security dialog box.
4. Click the Change Password button to change your fax security password but keep the same key set, or click New Key Set to create a new key set.

To use the key set to send and receive secured faxes, you must exchange public keys. To exchange public keys, you must save your public keys to a file that you can send to other users, or add other users' public keys to your address book.



To exchange a public key with another user in Microsoft Exchange

1. Click the Tools menu, point to Microsoft Fax Tools, and then click Advanced Security.
2. In the Advanced Security dialog box, click the Public Keys button.
3. In the Managing Public Keys dialog box, click Save.



4. In the Save Public Keys dialog box, click the public keys that you want in the listbox, and then click

the To: button to identify the folder where you want to save these keys. Type a name for the public keys with the file extension .AWP, and then click OK.

If you receive a public key from another user, you will need to import the .AWP key file into Microsoft Fax. After you and your recipient have exchanged public keys, you will be able to exchange secured faxes. The easiest way to exchange public keys is through electronic mail. Compose a message in Microsoft Exchange and insert your .AWP file into the message. The recipient must save the .AWP file to a directory and import the public keys into Microsoft Fax.



To import the .AWP file in Microsoft Exchange

1. Click the Tools menu, points to Microsoft Fax Tools, and then click Advanced Security.
2. In the Advanced Security dialog box, click Public Keys.
3. In the Public Keys dialog box, click Add, and then specify the path to the .AWP file.

Microsoft Fax

Security for Microsoft Fax

Sending Secured Faxes

Microsoft Fax allows you to secure a fax on a per-message basis.



To send a secured fax

1. In the Compose New Fax wizard, click the Options button, and then click the Security button.
2. In the Message Security Options dialog box, choose from the following methods of securing a fax:
 - Click the Key-Encrypted option to encrypt your fax by using RSA public key encryption.
 - Click the Password Protected option to assign a password to the fax.
 - Click the option named Digitally Sign All Attachments to apply a digital signature to a document that you have attached to a mail message. You can add a digital signature to a key-encrypted or password-encrypted fax.

Technical Notes for Microsoft Fax

This section describes technical information about Microsoft Fax architecture and Registry entries.

You can send faxes either by using the mail client or the Microsoft Fax printer driver. In each case, the message is sent to the Microsoft Fax service provider by using MAPI. If you sent the message from a mail client, it might contain text, embedded OLE formats, and attachments. If you sent it by using the Microsoft Fax printer driver, the mail message will contain a rendered format of the file as an attachment to the mail message.

MAPI allows messages to be preprocessed based on the transport protocol used to send them. The transport protocol chooses the correct modem connection, uses TAPI to create a dial string, and sends the message to that recipient. The preprocessor determines whether to render the message into a fax form to be printed by a fax machine. The rendered format is attached to the original message as a message property and is deleted either when the message is sent or when the transport protocol tries to send the message but determines it cannot.

If the message does not have to be rendered, the message is converted from its original binary format to a line image (also called a linearized form), and then it is compressed.

After the message is submitted, the transport protocol determines what type of recipient the message is intended for as follows:

- If it is a traditional fax recipient and the user has selected printed form or “best available,” Microsoft Fax will render the document into the standard Group 3 image format. This can be used by standard fax machines and software. If the user selects editable form, an error message is returned.
- If the recipient is a Microsoft At Work-enabled recipient and the user has selected printed form, then it will render the document into the Microsoft Fax rendered format. This format provides high-quality images of smaller size than standard Group 3 and it is used between Microsoft At Work devices, including fax machines and printers.
- If the recipient is a Microsoft Fax recipient and the user has selected editable form, no rendering is required.
- If there is a mix of recipients, and the user has selected “best available,” then Group 3 and editable versions of the document are packaged in the message.
- If the capabilities of the recipient are unknown, Microsoft Fax creates multiple formats to be sure that the proper format is available upon connect.

Fax-form messages sent to Microsoft At Work devices will be sent by using BFT with the resource-based rendering of the message sent as an attachment.

The Registry keys for a fax modem are found in:

`Hkey_Local_Machines\Software\Microsoft\At Work Fax\Local Modems`

For each local modem that has been installed by Windows 95, information is stored in the key named `TAPInnnnnnnn` where `nnnnnnnn` is an arbitrary number assigned by TAPI. The TAPI key contains subkey values. Values that are important to the system administrator are described in the following tables.

The following table lists the modem command strings used to reset the modem whenever Microsoft Fax acquires it from TAPI:

Subkey	Description
ResetCommand	<p>This “AT” command string includes:</p> <ul style="list-style-type: none"> • Load factory defaults: &F • Disable auto-answer: S0=0 • Echo OFF: E0 • Verbose ON: V1 • Quiet OFF: Q0 <p>The default depends on fax modem. Typically,</p>

AT&FS0=0E0V1Q0.

The following table lists the setup modem command string used to set up the modem before dialing or answering:

Subkey	Description
SetupCommand	This "AT" command string includes: <ul style="list-style-type: none">• Max dial-tone timeout: S7=255• Tie DTR drop to reset: &D3• XON/XOFF flow control: Varies The default depends on fax modem. Typically, ATS7=255&D3&K4 .
ExitCommand	This command string is issued to the modem after hang-up, and just before releasing the port. The default is empty.
FixSerialSpeed	This command string specifies the port speed. The default is 19200 .
PreAnswerCommand	This modem command string is issued to the modem just before issuing the ATA (answer) command. Microsoft Fax will have already issued the Setup command, and the command to go to the appropriate Fax Class (Class 1 or 2). The default is empty.
PreDialCommand	This modem command string is issued just before issuing an ATA (dial) command. Microsoft Fax will have already issued the Setup command, and the command to go to the appropriate Fax class (class 1 or 2). The default is empty.
HighestSendSpeed	This modem command string specifies the highest speed to try sending a fax, in bits per second. A value of 0 forces the highest available speed. The default is 0 .
LowestSendSpeed	This modem command string specifies the lowest speed to try sending a fax, in bits per second. A value of 0 forces the lowest available speed. The default is 0 .
EnableV17Send	If 0, this command string disables use of V.17 (14.4 kbps, short train) for sending. The default is 1 .
EnableV17Recv	If 0, this command string disables use of V.17 (14.4 kbps, short train) for receiving. The default is 1 .

Introduction

This chapter describes how to use Dial-Up Networking to access a network from a remote location. It also describes how other Windows 95 mobile computing tools, such as Briefcase and Direct Cable Connection, can be used to connect to desktop computers or the network.

Important The dial-up server capabilities discussed in this chapter are only available if you purchase Microsoft Plus! for Windows 95. For more information contact your Microsoft sales representative.

- [Dial-Up Networking and Mobile Computing: The Basics](#)
- [Dial-Up Networking and Mobile Computing: The Issues](#)
- [Overview of Dial-Up Networking](#)
 - [Dial-Up Clients and Servers](#)
 - [Connection Protocols](#)
 - [Local Area Network Protocols](#)
- [Installing Dial-Up Networking](#)
- [Configuring Dial-Up Networking Clients and Servers](#)
 - [Installing Protocols](#)
 - [Defining a Dial-Up Networking Connection](#)
 - [Configuring a Windows 95 Dial-Up Client](#)
 - [Making a Dial-Up Networking Connection](#)
 - [Configuring a Windows 95 Dial-Up Server](#)
 - [Disabling Dial-Up Server Support](#)
 - [Using Security with Dial-Up Networking](#)
 - [Using Software and Hardware Compression to Transfer Data](#)
 - [Connecting to a Windows NT Remote Access Server](#)
 - [Configuring a Windows NT Server for Windows 95 Dial-Up Clients](#)
- [Connecting to a Novell NetWare Connect Server](#)
- [Connecting to Shiva Remote Access Servers](#)
- [Technical Notes On Dial-Up Networking](#)
 - [PPP Dial-Up Sequence](#)
 - [PPP Log File](#)
- [Overview of Windows 95 Mobile Computing Features](#)
- [Direct Cable Connection](#)
 - [Installing and Configuring Direct Cable Connection](#)
 - [Cables Compatible with Direct Cable Connection](#)
- [Using Briefcase for File Synchronization](#)
 - [Creating and Configuring a Briefcase](#)
 - [Updating Files with Briefcase](#)
- [Troubleshooting Dial-Up Networking](#)

Dial-Up Networking and Mobile Computing: The Basics

Dial-Up Networking allows mobile users to work as if they are connected directly to the network. Establishing a network connection by using Dial-Up Networking works the same as establishing a network connection in the office — you just double-click a network resource.

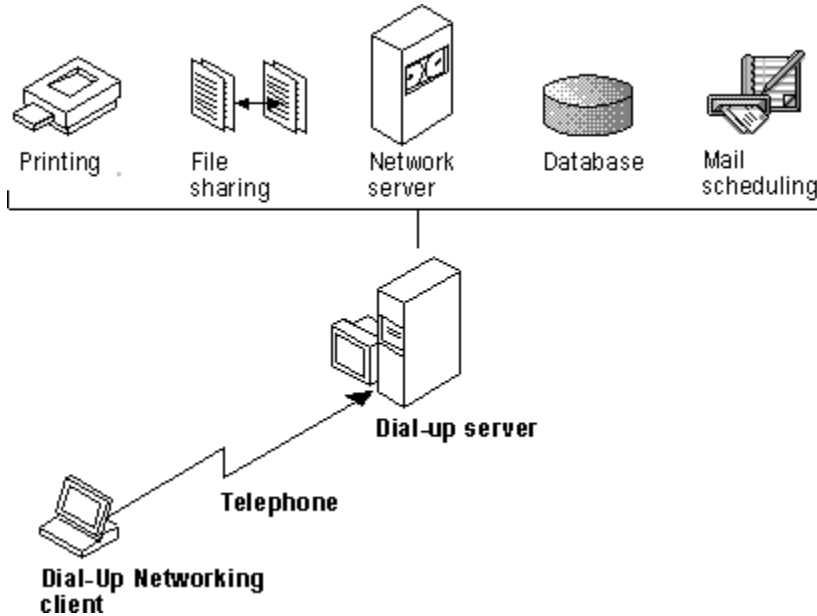

The Windows 95 Dial-Up Networking subsystem allows mobile users to designate a computer running Windows 95 as a dial-up client or server. From a remote site, you can use Dial-Up Networking to connect the dial-up client to a Windows 95 dial-up server or other remote access servers, such as Shiva® NetModem or LanRover, Novell® NetWare® Connect, and Windows NT version 3.1 or 3.5 Remote Access Service (RAS). If the client and server are running the same network protocols, the dial-up client can connect to the network to access its resources.

Notice that a Microsoft Windows NT Client Access License is required if the computer will be connecting to servers running Windows NT Server. For information, see [Windows 95 on Microsoft Networks](#), or contact your Microsoft reseller.

Windows 95 provides the following tools to help users stay as functional as possible with the limited resources of a mobile site.

Remote mail.

With the Microsoft Exchange client and a Microsoft Mail workgroup postoffice, mobile users can dial in to the network to send and receive electronic mail, without requiring any additional client software or a special gateway server. To send and receive mail, mobile users make a Dial-Up Networking connection to another computer running Windows 95 to another remote access server connected to their workgroup postoffice. After connecting, they use Microsoft Exchange to send and receive their mail.

Direct Cable Connection.

This tool allows you to quickly and easily establish a connection between two computers by using a parallel cable or null-modem serial cable. After the connection is established, Direct Cable Connection facilitates the transfer of files from the host computer to the guest computer. The host can act as a gateway to a IPX/SPX or NetBEUI network for the guest.

Windows 95 Briefcase.

This file synchronization tool minimizes the task of keeping track of the relationships between files on a portable computer and on a desktop computer. With Briefcase, a user can simultaneously update related files.

Deferred printing.

Windows 95 supports deferred printing, which allows mobile users to generate print jobs when they are not connected to a printer. The print jobs are stored until a printer becomes available. Windows 95 detects the printer connection and automatically spools the print jobs in the background.

Dial-Up tools from other vendors.

This chapter describes how to use Dial-Up Networking with Windows NT, Shiva, and NetWare remote access servers. For information about using Windows 95 Dial-Up Networking to dial in to other remote access servers, or using other remote access software to dial in to Windows 95, contact your network vendor or software supplier.

Dial-Up Networking and Mobile Computing: The Issues

To run Dial-Up Networking, the computer must have a protected-mode client, that is, one that can use the Windows 95 protected-mode transports, or others that use NDIS and provide appropriate PPP drivers. This means that you cannot use a Novell real-mode client over Dial-Up Networking, but you can use Microsoft Client for NetWare Networks.

To use Dial-Up Networking to connect to the network, you need the following hardware:

- One or more compatible modems, as described in [Modems and Communications Tools](#).
- Enough available hard disk space to install Dial-Up Networking. Currently, about 2 to 3 MB of free disk space is required to install the client and server portions of Dial-Up Networking.

To use Dial-Up Networking to connect to the network, you will need to decide the following:

- Which computers on the network will function as Windows 95 dial-up servers. (Dial-up server capabilities are only available if you purchase Microsoft Plus! for Windows 95.)
- What kind of remote access server, other than a Windows 95 dial-up server, remote users will connect to. For example, a Windows 95 dial-up server allows only one remote connection at a time, whereas a Windows NT 3.5 remote access server allows 256 connections. Depending on the size and needs of your network, you might configure a Windows 95 dial-up client to connect to a Windows NT 3.5 server or other remote access server. For a list of the types of remote access servers that a Windows 95 dial-up client can be configured to connect to, see [Dial-Up Clients and Servers](#).
- What type of connection protocol your dial-up client will use to connect to the remote access server. Windows 95 provides support for Point-to-Point protocol (PPP), RAS for Windows for Workgroups 3.11 and Windows NT 3.1, NetWare Connect, and Serial Line Internet Protocol (SLIP). The dial-up client and the remote access server must both be running the same connection protocol. For a complete list of protocol types, see [Connection Protocols](#).
- What kind of local area network protocol to install on the dial-up client and server to connect the client to the network. Windows 95 supports IPX/SPX, Microsoft TCP/IP, and Microsoft NetBEUI protocols. For more information about network protocols and Dial-Up Networking, see [Local Area Network Protocols](#).
- Whether you want to share the resources of a Windows 95 dial-up server. To enable a dial-up client to access files and printing capabilities of a dial-up server, you must install File and Printer Sharing services in the Network option in Control Panel, and also enable Allow Caller Access when configuring either user-level or share-level security on the dial-up server. For more information, see [Configuring a Windows 95 Dial-Up Server](#) and [Using Security with Dial-Up Networking](#).
- What level of security you need for dial-up servers. You can enable either user-level or share-level security on a Windows 95 dial-up server. Both types of security provide password protection for the dial-up process, but do not support callback authentication. A Windows 95 dial-up client does support callback authentication when connected to other types of remote access servers, such as Windows NT Server, that supports callback authentication. For more information, see [Using Security with Dial-Up Networking](#).
- Whether you need additional security. Windows 95 supports hardware security tools from other vendors for dial-up access, plus authentication protocols such as CHAP and SPAP.

Overview of Dial-Up Networking

With Dial-Up Networking, you can connect from a remote site to a computer that has been configured as a remote access server, or connect to a network through the remote access server. For example, if you connect to a Windows 95 dial-up server, you can share its resources (if the Microsoft File and Printer Sharing service has been enabled), or you can use it as a gateway to a network that is running IPX/SPX and NetBEUI network protocols. As shown in the following figure a Windows 95 dial-up client can connect to a wide variety of networks because support is included for a variety of connection and network protocols.

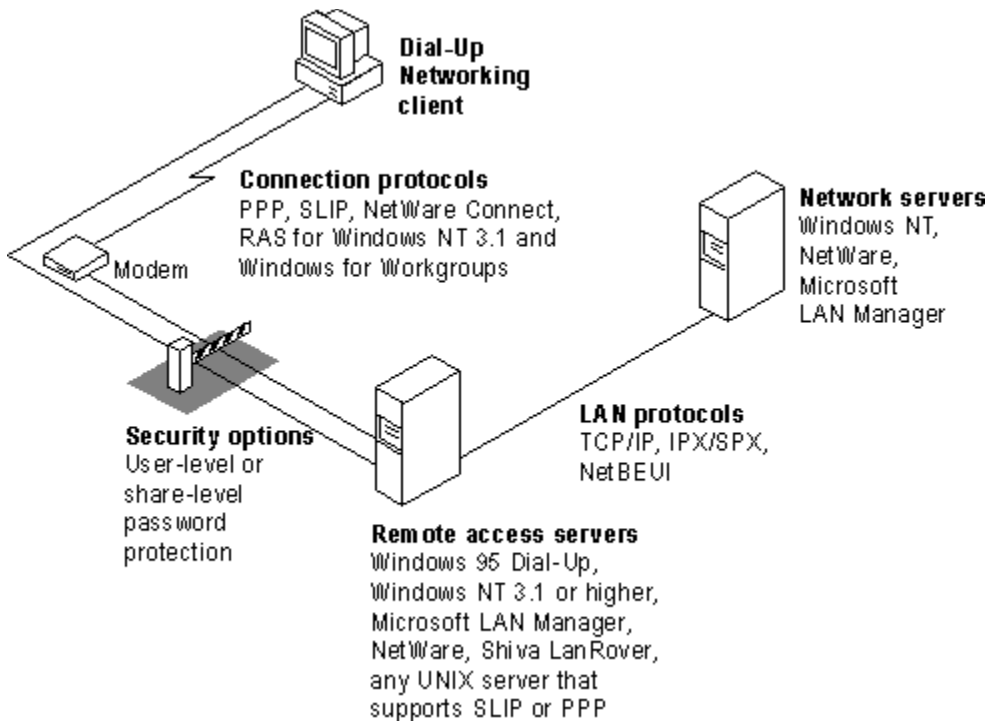

Different remote access servers provide different security systems to protect access to a network. The Windows 95 dial-up server uses pass-through user-level or share-level security as described in [Using Security with Dial-Up Networking](#).

You can use system policies and other methods to disable dial-in access so users cannot dial in to a particular desktop computer. For information, see [Disabling Dial-Up Server Support](#). If the user chooses to dial in to a host system such as Windows NT, Shiva NetModem or LanRover, or NetWare Connect, Windows 95 offers full connectivity.

Dial-Up Networking uses the Windows 95 communications architecture to communicate through a modem to a network. It initializes the modem, determines device status, and dials the phone number by using TAPI and the Unimodem driver. For more information, see [Introduction to Windows 95 Communications](#).

A Windows 95 Dial-Up Networking configuration includes these components, as described in the following sections:

- Dial-Up clients and servers
- Connection Protocols
- Network (LAN) protocols and network servers
- Security options

Dial-Up Clients and Servers

With Dial-Up Networking, you can configure a remote computer running Windows 95 as a dial-up client to dial in to a Windows 95 dial-up server or other remote access servers. A dial-up client, running the appropriate connection protocol, can connect to many types of remote access servers, including the following:

- Windows 95 dial-up server
- Windows NT Workstation
- Windows NT 3.1 or later
- Windows for Workgroups 3.11
- NetWare Connect
- Shiva LanRover and other dial-up routers
- Any UNIX® server that runs SLIP or PPP

Connection Protocols

Connection protocols control the transmission of data over the wide-area network (WAN). A Windows 95 dial-up client can use the following connection protocols to connect to a remote access server:

- Point-to-Point Protocol (PPP)
- Novell NetWare Connect
- Windows NT 3.1 or Windows for Workgroups RAS (Asynchronous NetBEUI)
- Serial Line Internet Protocol (SLIP)

The type of connection protocol you choose depends on the server you are connecting to. Some connection protocols support a subset of the common network protocols. For example, PPP allows you to connect to a network server or a computer running Windows 95 with TCP/IP, IPX/SPX-compatible, or NetBEUI network protocols.

The following is a summary of connection protocols.

Point-to-Point Protocol (PPP).

PPP has become the standard for remote access. Microsoft recommends that you use PPP because of its flexibility and its role as an industry standard, and for future flexibility with client and server hardware and software. If a dial-up client is running PPP, it can connect to a network running IPX, TCP/IP, or NetBEUI protocols. PPP is the default protocol for the Microsoft Dial-Up adapter.

Novell NetWare Connect.

NetWare Connect is a proprietary connection protocol. It allows a computer running Windows 95 to directly connect to a NetWare Connect server and, if running a NetWare-compatible network client, connect to NetWare servers. Windows 95 can only act as a client for connecting to a NetWare Connect server. NetWare Connect clients themselves cannot connect to a Windows 95 dial-up server directly through dial-up.

RAS for Windows NT 3.1 and Windows for Workgroups 3.11.

This protocol (asynchronous NetBEUI) is used to connect computers running Windows 95 to remote access servers running Windows NT 3.1 or Windows for Workgroups 3.11, or to connect computers running Windows for Workgroups 3.11 or Windows NT 3.1 to a Windows 95 dial-up server. The remote access server must be running NetBEUI.

Serial Line Internet Protocol (SLIP).

SLIP is an older remote access standard that is typically used by UNIX remote access servers. Use SLIP only if your site has a UNIX system configured as a SLIP server for Internet connections. The remote access server must be running TCP/IP.

Windows 95 does not provide SLIP server capabilities; SLIP is for dial-out only. Support for SLIP can be found on the Windows 95 compact disc.

Local Area Network Protocols

Windows 95 makes it easy to configure dial-up clients and servers to access a network. When you install Dial-Up Networking, any protocols already installed on the computer are automatically enabled for Dial-Up Networking. Windows 95 includes support for TCP/IP, IPX/SPX, and NetBEUI network protocols. To configure the Windows 95 dial-up server to act as a gateway to a network, you must ensure that it and the dial-up client are running the same network (LAN) protocol as your existing network. A Windows 95 dial-up server can act as a gateway only to a network running IPX/SPX and NetBEUI protocols.

The following table presents the combinations of protocols you can use to run either Windows Sockets or NetBIOS applications on a network.

Connection protocols	Network protocols (APIs)
NetWare Connect	IPX/SPX (Windows Sockets/NetBIOS)
PPP	TCP/IP (Windows Sockets/NetBIOS) IPX/SPX (Windows Sockets/NetBIOS) NetBEUI (NetBIOS)
RAS for Windows NT 3.1 or Windows for Workgroups 3.11	NetBEUI (NetBIOS)
SLIP	TCP/IP (Windows Sockets/NetBIOS)

Note You do not need to install any network protocols when you install Dial-Up Networking; NetBEUI and the IPX/SPX-compatible protocol are automatically installed and bound to the Microsoft Dial-Up adapter. You can add protocols by using the Network option in Control Panel.

A Windows 95 dial-up server cannot act as a gateway to SLIP, TCP/IP, or IPX (over NetWare Connect) networks, as shown in the following graphic.

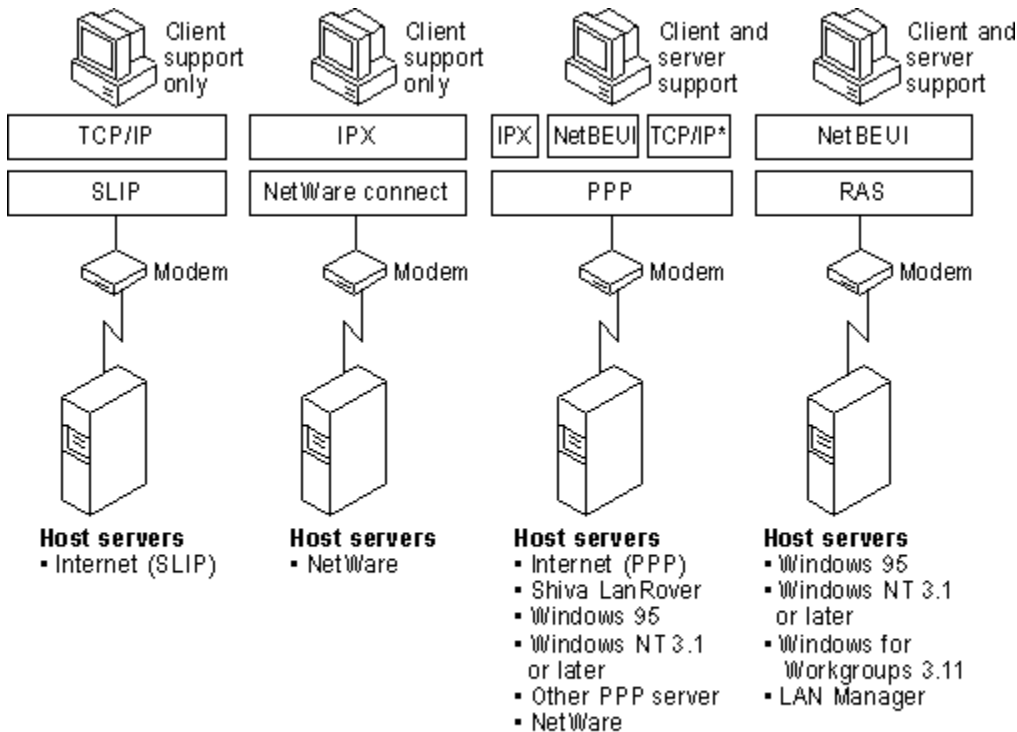

*A Windows 95 dial-up server configured with TCP/IP over PPP cannot act as a gateway to a TCP/IP network.

A Windows 95 dial-up server configured with TCP/IP over PPP cannot act as a gateway to a TCP/IP network.

Note If a Windows 95 dial-up server is running TCP/IP and NetBIOS over TCP/IP, then the dial-up client can access NetBIOS and TCP/IP resource on the network.

Installing Dial-Up Networking

When you install Dial-Up Networking, you are installing all the components you need to connect to a network. For example, installing Dial-Up Networking also installs the Microsoft Dial-Up adapter, and connection and network protocols.

Before you dial up a remote connection using a modem and Dial-Up Networking, you need to make sure all the appropriate network protocols are bound to the Microsoft Dial-Up adapter or a network adapter. The easiest way to install Dial-Up Networking is during installation of Windows 95. If you didn't choose it during Setup, you can install it afterward.

Note If you are currently using Windows for Workgroups 3.11 with RAS, Dial-Up Networking will automatically be installed when you upgrade to Windows 95.



To install Dial-Up Networking after you run Setup

1. In the Add/Remove Programs Option in Control Panel, click the Windows Setup tab.
2. In the Components list, click Communications, and then click the Details button.
3. In the Communications dialog box, click Dial-Up Networking, and then click OK.

After it is installed a folder for Dial-Up Networking appears in My Computer. To run Dial-Up Networking, double-click the folder.

Configuring Dial-Up Networking Clients and Servers

Configuring computers as Dial-Up Networking clients or servers consists of four tasks:

- Installing the appropriate network protocols and making sure they are bound to the Microsoft Dial-Up adapter. All network protocols installed before you install Dial-Up Networking are automatically bound to the Microsoft Dial-Up adapter when you install Dial-Up Networking.
- Running the Make New Connection wizard in Dial-Up Networking to set up a connection to a remote access server for the dial-up client. If you have not yet installed a modem, the wizard guides you through installing one.
- Configuring the dial-up client in Dial-Up Networking by selecting the remote access server type it will connect to, and by choosing whether to log on to the network after connecting to the remote access server. Selecting the server type automatically enables the correct connection protocol, such as PPP or SLIP.
- Optionally, installing dial-up server capabilities and configuring a computer running Windows 95 as a dial-up server in the Dial-Up Server menu in Dial-Up Networking.

Dial-Up Networking and Mobile Computing

Configuring Dial-Up Networking Clients and Servers

Installing Protocols

Windows 95 automatically binds the default network protocols to the Microsoft Dial-Up adapter when you install Dial-Up Networking. For most networks, these typically are the IPX/SPX-compatible and NetBEUI protocols. You can install other network protocols, such as TCP/IP, by using the Networks option in Control Panel. For information about adding protocols, see [Network Technical Discussion](#).



To make sure the correct protocols are bound to the Microsoft Dial Up adapter or other network adapter

- In the Network option in Control Panel, each protocol (in the Components list box) that is bound to the Microsoft Dial-Up adapter will show an arrow pointing to the adapter.

Defining a Dial-Up Networking Connection

Windows 95 guides you through making a new remote connection when you first run Dial-Up Networking. Before creating a new Dial-Up Networking connection, you should install a modem. The Make New Connection wizard prompts you to do so, or you can install it separately by using the Install New Modem wizard in the Modems option in Control Panel. For information, see [Modems and Communications Tools](#).



To create a Dial-Up Networking connection using the Make New Connection wizard

1. From My Computer, double-click the Dial-Up Networking folder.
2. In the Dial-Up Networking window, double-click the Make New Connection icon.
3. The Make New Connection wizard prompts you for the information needed to define a connection, including a name for the computer you are dialing, modem type, area code, telephone number, and country code.

The new icon for your connection appears in the Dial-Up Networking window. You need to provide this information only once for each connection you define.

Note You can adjust the dialing string in Dialing Properties, which is accessible from the Connect To dialog box that appears when you double-click a connection icon.

When a user connects to a remote server, a terminal window can be displayed to support an interactive logon session with the server. After a connection is established, remote network access becomes transparent to the user.



To make sure a network connection has been established

- Double-click Network Neighborhood, click Map Network Drive, and then type a path name to a network server.



To display a terminal window before or after dialing

1. Click a connection icon, click the File menu, and then click Properties.
2. In General properties, click the Configure button, and then click the Options tab.
3. In the Options dialog box, click the option named Bring Up Terminal Window Before Dialing or the option named Bring Up Terminal Window After Dialing.

Tip for Using Dialing Properties to Change Location Information

Dial-Up Networking is a TAPI-enabled application. This means that Dial-Up Networking can offload the work of matching the correct phone dialing string from the location to the TAPI components designed for that role. When you attempt a Dial-Up Networking connection, you can choose to edit your calling location by using Dialing Properties.

With Dialing Properties, you can specify area code, special numbers needed to reach an outside line, and calling card information you may need for the connection number. The Windows 95 TAPI services will then automatically adjust the dial string it sends to your modem.

The configurations you set up for each connection are stored in the Registry under

`Hkey_Current_User\RemoteAccess\Addresses\My Connection`

You can predefine Dial-Up Networking connections for users by including them as part of system policies. If you enable user profiles, different users sharing the same computer can use separate dialing configurations. For more information, see [User Profiles and System Policies](#).

Configuring a Windows 95 Dial-Up Client

You configure the Windows 95 dial-up client for each dial-in connection you define in Dial-Up Networking. Configuration consists of selecting the remote access server type to connect to and choosing whether to access the network after connecting to the remote access server. In addition, you can require an encrypted password to connect to a remote access server and check to see if the correct network protocols are installed on the dial-up client. Windows 95 automatically selects the appropriate connection protocol when you select the remote access server type for each Dial-Up Networking connection.

Windows 95 supports only SLIP as a client. The SLIP client software is provided on the Windows 95 compact disc.

Microsoft Plus! for Windows 95 provides a scripting application that can be used by Dial-Up Networking for connecting to remote servers using SLIP. With this application installed, a user can associate an existing dial-in connection with a text file (script) to be run after the modem dials the remote server. This script sends the server a user ID and a password, and requests an IP address from the server. Dial-Up Networking automatically updates the properties for the dial-in connection with the IP address returned by the server. For more information about the scripting application, see the README.TXT file provided with Microsoft Plus!



To install SLIP

1. In Add/Remove Programs in Control Panel, click the Windows Setup tab, and then click the Have Disk button.
2. In the Install From Disk dialog box, click the Browse button, and then type the path name to ADMIN\APPTOOLS\SLIP\RNAPLUS.INF.
3. In the Have Disk dialog box, click UNIX Connection For Dial-Up Networking, and then click Install.



To configure the Windows 95 dial-up client

1. In Dial-Up Networking, right-click a connection icon, and then click Properties.
2. In General properties, click the Server Type button.

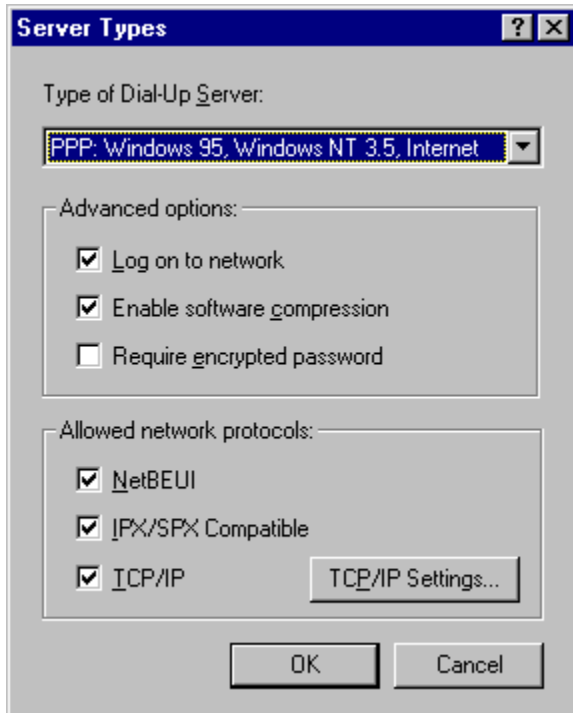

3. In the Server Types dialog box, select the correct remote access server type.

This server type Connects to

PPP: Windows 95, Windows NT 3.5, Internet This is the default; selecting this allows Windows 95 to automatically detect and connect to other remote access servers that are running TCP/IP, NetBEUI, or IPX/SPX over PPP

NRN: NetWare Connect Novell NetWare Connect running IPX/SPX over NetWare Connect

Windows for Workgroups and Windows NT 3.1 Windows 95 dial-up server; Windows NT version 3.1 or 3.5; Windows for Workgroups version 3.11 running NetBEUI over RAS

SLIP: UNIX Connection Any SLIP server over TCP/IP

CSLIP: UNIX Connection with IP Header Compression Any SLIP server over TCP/IP that supports IP header compression

4. Optionally, click the option named Log On To Network to allow access to the network after connecting to the remote access server. Notice that this option is selected by default.
If you choose this option, Dial-Up Networking attempts to log you on to the network using the user name and password you typed when you logged on to Windows 95. The logon prompt differs depending on whether the computer is running Client for Microsoft Networks or Client for NetWare Networks, and whether your password for the network is the same as your Windows 95 password. For information, see [Logon, Browsing, and Resource Sharing](#).
5. Optionally, click the option named Enable Software Compression to compress information before sending it.
6. Optionally, click the option named Require Encrypted Password to require the user to type in an encrypted password before accessing the dial-up server. For information, see [Using Security with Dial-Up Networking](#).

Tip If users are having trouble making remote access connections, check to see if a specific server type was selected. When a specific connection type is selected, Windows 95 will not attempt to connect using any other server type.

7. Optionally, click TCP/IP settings if you are configuring a connection to the Internet. For information, see [Internet Access](#).

Making a Dial-Up Networking Connection

After you have defined a remote connection by using the Make New Connection wizard, you can make a connection in two ways:

- Double-click a connection icon in Dial-Up Networking.
- Connect to a remote network resource when you are working in an application other than Dial-Up Networking. If you cannot find the resource on the current network, Windows 95 responds by automatically activating Dial-Up Networking.

After you establish or end a connection, you do not need to restart the computer or restart Windows 95. When you attempt to perform the following tasks, Windows 95 starts Dial-Up Networking:

- When you try to access a network resource and your computer is not connected to any network
- When your application specifies a UNC name (which uses the form `\\servername\sharename`) that can't be accessed by using the local area network
- When you double-click a link that points to a remote network object; for example:
 - When an application attempts to connect to a file on a network server
 - When you reconnect to a remote OLE object

When you choose a remote connection, Windows 95 retrieves the server information from the addresses stored in the Registry. If the information is not available, you are asked to select a server from the connection icons in Dial-Up Networking, or to type a new server name.

If Dial-Up Networking cannot find the network resource, it displays a net error message. If the connection is successful, Windows 95 remembers the connection for future use.

You can disable the prompt that asks if you want to use Dial-Up Networking when you are attempting to connect to a network resource.



To disable the Dial-Up Networking prompt

1. In Dial-Up Networking, click the Connection menu, and then click Settings.
2. Click the option named Don't Prompt To Use Dial-Up Networking.

Configuring a Windows 95 Dial-Up Server

With Dial-Up Networking, you can configure a computer running Windows 95 to be a remote access server for dial-up clients running Windows 95, Windows for Workgroups, or Windows 3.1. The Windows 95 dial-up server can act as a gateway to an IPX/SPX or NetBEUI network, or as a server to the client, sharing its file and printing resources with one dial-up client at a time.

Note Dial-up server capabilities are only available if you purchase the Microsoft Plus! for Windows 95. For information, contact your Microsoft sales representative.

A Windows 95 dial-up server differs from the Windows NT 3.5 dial up server in the following ways:

- Windows NT 3.5 Server can act as an IP router, and Windows 95 cannot. IP router capabilities permit accessing a TCP/IP network, such as the global Internet. Windows 95 provides all the protocols you need to connect to the Internet, but cannot act as an IP router. Consequently, you need to connect a computer running Windows 95 to a server with IP router capabilities in order to connect to the Internet.
- Windows NT 3.5 supports 256 remote connections, whereas Windows 95 provides one remote connection.

The Windows 95 dial-up server supports the following remote access clients:

- Windows 95 dial-up client
- Windows for Workgroups
- Windows 3.1 RAS client
- Clients running PPP

A Windows 95 dial-up server with the appropriate network protocols installed can act as a NetBIOS gateway, as shown in the following illustration.

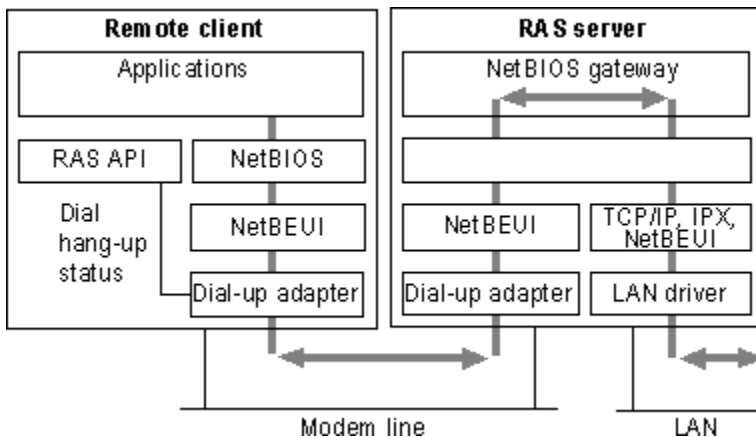

For more information about connectivity options for a Windows 95 dial-up server, see [Overview of Dial-Up Networking](#).

Configuring a computer running Windows 95 to be a dial-up server consists of the following steps:

- Enabling File and Printer Sharing services for either Microsoft or NetWare networks on the dial-up server.
- Enabling user-level or share-level security on the dial-up server. For information, see [Using Security with Dial-Up Networking](#).
- Configuring dial-up server capabilities in Dial-Up Networking, as described in the following procedure.



To configure a computer as a dial-up server

1. From the Connections menu in the Dial-Up Networking, click Dial-Up Server.
2. In the Dial-Up Server dialog box, click Allow Caller Access. This dialog box will look different depending on whether you have enabled user-level or share-level security for the computer.
3. Optionally, click Change Password to define a call-in password for Dial-Up Networking clients, and then click OK.

-Or -

If you are using user-level security for peer resource sharing, select the users who have access to this dial-up server. Then click OK.

4. Click the Server Type button and then select the server type.
If you select the Default server type, the dial-up server will automatically start in PPP mode for incoming calls and switch to RAS for Windows NT 3.1 and Windows for Workgroups mode if the PPP negotiation fails.
5. Click OK, and the dial-up server will be ready to answer incoming calls.

Notice that changes to the server type do not apply to a connection that is currently open. Changes will apply to any future connections made to this computer.



To disconnect any users who are currently connected to this computer through Dial-Up Networking

- In the Dial-Up Server dialog box, click the Disconnect User button.

Note The Microsoft Plus! Dial-Up Server for Windows 95 can use only one modem at a time. You can enable caller access on multiple modems at any one time, but only one modem can be connected.

Disabling Dial-Up Server Support

You can prevent users from remotely accessing computers even if a remote connection has been previously established. You can restrict access by making direct changes to a computer's dial-up support capabilities or by using System Policy Editor to create a policy file.



To disable the dial-up server on a single computer

1. From the Connections menu in the Dial-Up Networking window, click Dial-Up Server.
2. In the Dial-Up Server dialog box, click the option named No Caller Access.

You can disable dial-up support on each computer or on a system-wide basis by using System Policy Editor to change a single computer's Registry or to define policies that can be shared by multiple computers.

To disable dial-up support by using System Policy Editor, enable the option named Disable Dial-in. The Dial-Up Server menu option still appears on the Connections menu after dial-up support has been disabled, but no dialog box for setting up the dial-up server will appear. For more information, see [User Profiles and System Policies](#).

Using Security with Dial-Up Networking

Dial-Up Networking gives you the option of requiring a password to connect to the remote access server, depending on whether the Windows 95 dial-up server is protected with share-level or user-level security.

- Share-level security assigns a password to the Windows 95 dial-up server. When users dial in, they must provide the password before they can gain access to the server. After the connection is established, users can browse the resources on the dial-up server, subject to whatever level of security has been applied to them. Users can also log on to the network after connecting to the dial-up server if logging on to the network is enabled on the dial-up client. Because users can distribute passwords, this method is less secure than user-level security.
- User-level security restricts access to a network resource until a security provider, such as a Windows NT domain controller or a NetWare server, authenticates the request. You can require that a user's logon password to a remote access server be the same as the network and Windows 95 logon passwords.

With user-level security, when the user accesses shared resources on the dial-up server, Windows 95 controls what rights a user has to the shared resources, such as whether the user has read-only access or full access to files. Access rights are specified in the sharing properties for each resource protected by user-level security. For more information, see [Security](#), and [Logon, Browsing, and Resource Sharing](#).



To configure the dial-up server to use user-level security

1. In the Network option in Control Panel, enable File and Printer Sharing services for Microsoft or NetWare networks and enable user-level security in Access Control properties.
2. In Dial-Up Networking, click the Connections menu, and then click Dial-Up Server.
3. In the Dial-Up Server properties, click the option named Allow Caller Access, and then click Add.
4. In the Add Users dialog box, specify the users who will have permission to access the dial-up server, and then click OK.
5. In the Dial-Up Server properties, click the Server Type button, and make sure Require Encrypted Password is checked if your Dial-Up client supports encrypted passwords.

Clicking the Require Encrypted Password option requires the client to send an encrypted as opposed to a text password. Some clients support only text passwords; however, encrypted passwords are preferred. Clearing this option doesn't disable password protection.



To configure the dial-up server to use share-level security

1. Disable user-level security, if it is enabled, by clicking the Access Control tab in the Network option in Control Panel, or by using System Policy Editor to edit the Registry.
2. In the Network option in Control Panel, enable File and Printer Sharing services for Microsoft Networks and enable share-level security by clicking the Access Control tab. Notice that share-level security is not available on NetWare networks.
3. From the Connections menu in Dial-Up Networking, click Dial-Up Server.
4. In the Dial-Up Server dialog box, click Allow Caller Access, and then click Change Password to provide password protection for the Dial-Up server.
5. Optionally, to require password encryption, click the Server Type button. In the Server Types dialog box, make sure Require Encrypted Password is checked, and then click OK.

Using Software and Hardware Compression to Transfer Data

To improve the throughput and transfer times when you use Dial-Up Networking, Windows 95 supports dynamic compression of information when you are connected to another computer that also understands compression — for example, a computer running Windows 95 or Windows NT.

You can choose to use either software compression (specified through the Dial-Up Server dialog box) or hardware compression. *Software compression* is performed by the remote access software; *hardware compression* is performed by the modem.

Choosing software compression specifies that your computer will try to compress information before sending it. Compression will occur only if the computer you are connecting to is using a compatible compression program.

Note Software compression is supported only in PPP mode, not in RAS, NetWare Connect, or SLIP modes. Software compression is enabled by default in PPP mode and is preferred over hardware compression because it reduces the amount of information that needs to be transmitted to the modem.



To choose software compression

1. From the Dial-Up Networking Connections menu, click Dial-Up Server.
2. In the Dial-Up Server dialog box, click the Server Type button.
3. In the Server Types dialog box, make sure the Enable Software Compression is checked.

Note The software compression option is not available when you are connecting to a Windows NT 3.1 or Windows for Workgroups 3.1 remote access server.

Hardware compression is available on most newer modems at higher connection speeds. For example, V.42bis is an industry standard that allows modems to do data compression on all the data sent through them.



To choose hardware compression

1. In the Modems option in Control Panel, click the Properties button, and then click the Connection tab.
2. In the Connection dialog box, click the Advanced button and then click use Error Control, and Compress Data.

You should leave both software and hardware compression enabled unless you are certain that the server supports software compression. When you use either type of compression on data that is already compressed, you won't see any transfer time improvement. If the computer you are connecting to doesn't support compression, these settings are ignored and data is sent uncompressed over the wire.

Connecting to a Windows NT Remote Access Server

Connecting to a Windows NT remote access server is the same as connecting to a Windows 95 Dial-Up Networking server. All you need is the phone number of the Windows NT server when creating a connection. Dial-Up Networking negotiates the proper protocols and server connection type. You don't need to specify a default server type.

Windows NT 3.5 Server supports PPP, RAS, and SLIP clients. PPP is the recommended protocol. Windows NT 3.5 supports IPX/SPX, NetBEUI, and TCP/IP network protocols and can function as a NetBIOS gateway, IPX router, and IP router simultaneously. Windows NT 3.5 is not a SLIP server.

Note Windows NT 3.1 supports only the RAS protocol, which is a proprietary protocol that supports only NetBEUI. It is a fast connection type, but does not allow for multiple protocols over the connection. RAS in Windows NT 3.1 cannot support the IPX/SPX or TCP/IP protocols.

Microsoft recommends that you upgrade from Windows NT Remote Access Service to Windows NT Server 3.5, which provides many additional benefits, including PPP support.

A Windows NT 3.1 or 3.5 remote access server provides several features that a Dial-Up Networking server does not. For an explanation of these differences, see [Configuring a Windows 95 Dial-Up Server](#).

For more information about configuring a Windows NT 3.5 Server for Windows 95 Dial-Up client, see also the *Windows NT Server Remote Access Service Guide*.

Configuring a Windows NT Server for Windows 95 Dial-Up Clients

To configure a Windows NT 3.5 Server so that Windows 95 dial-up clients can remotely access it, you need to install and configure RAS.

You must be logged on as a member of the Administrators group to install and configure RAS. It can be installed during Custom Setup of Windows NT or afterward. During Express Setup, if there is not a network adapter in a computer, the user is given the option to install RAS.

RAS installation varies slightly depending on which network protocols are installed. If you use TCP/IP or IPX/SPX protocol with RAS, you should install the protocol before you install RAS, although selecting a protocol that is not installed causes that protocol to be installed at the conclusion of RAS Setup. For information about installing either protocol, see the *Windows NT Installation Guide*.



To install RAS on a computer running Windows NT 3.5 Server

1. In the Network option in Control Panel in Windows NT 3.5, click the Network Settings dialog box, and then click Add Software.
2. In the Network Software drop-down list, click Remote Access Service, and then click the Continue button.
3. Type the path name to the distribution files, and click OK.
RAS files are copied to the computer.
4. In the Add Port dialog box, click the port you intend to use for remote access, and then click OK.
If you have successfully installed a multiport adapter, ISDN card, X.25 card, or other device, it should appear in this list.
5. In the RAS Auto Detection dialog box, click OK to allow RAS to automatically detect the modem connected to the port, or click Cancel to manually select a modem.
Occasionally, when attempting to detect a modem, a dialog box appears, prompting you to select a modem from a short list. This occurs only when RAS Setup cannot distinguish between two or more modems.
6. In the Configure Port dialog box, click a modem if RAS did not detect one, and then click OK. Only supported modems are listed.
If you are adding a port after initial RAS installation, you can use the Detect button to automatically detect the modem connected to the new port.
7. In the Port Usage box, you define whether the port will be for dial-out or dial-in use. Clicking the Dial Out Only option configures the computer as a RAS client. Clicking the Receive Calls Only option configures the computer as a RAS server. Clicking both options allows the computer to be a dial-out client and dial-out server; however, the computer cannot be both at the same time.
8. To configure settings specific to the device attached to the port, click the device, and then click the Settings button. The default settings are usually ideal. Click OK.
9. In the Remote Access Setup dialog box, configure RAS network settings by clicking the Network button. You can also reconfigure the port, if necessary, by clicking it, and then clicking buttons at the bottom of the port dialog box.

Before users can use RAS to remotely connect to Windows NT, you must grant them remote access permissions.



To grant Remote Access permission to users

1. Double-click the Remote Access Admin icon to start the Administrators utility.
2. Set the focus on the server or domain on which you want to set permissions. To set the focus, see the Remote Access Admin online Help.
3. From the Users menu, click Permissions.
4. In the Remote Access Permissions dialog box, click the Help button for further instructions.

Note Microsoft does not recommend granting guest accounts dial-in permission. If you do, be sure to assign a password to the guest account.

Connecting to a Novell NetWare Connect Server

Windows 95 Dial-Up Networking supports connecting to Novell NetWare resources in two ways:

- Connecting directly to a Novell NetWare Connect server
- Using a computer running Windows 95 or Windows NT 3.5 as a gateway into a local area network, where NetWare servers are connected

NetWare Connect allows a Windows 95 client to dial in to a NetWare server running NetWare Connect 1.0.

Note Windows 95 can act only as a client for connecting to a NetWare Connect server. NetWare Connect clients themselves cannot dial up a Windows 95 dial-up server.

The NetWare Connect connection type allows a Windows 95 client to connect directly to a NetWare Connect server and to connect to NetWare servers on the connected local area network.

To use Dial-Up Networking to connect to a NetWare Connect server, you must specify NetWare Connect as the server type in the properties for a Dial-Up Networking connection. You also need to use the Network option in Control Panel to make sure the following are enabled on a Windows 95 dial-up client or server:

- Microsoft Client for NetWare Networks
- IPX/SPX-compatible protocol bound to the Microsoft Dial-Up adapter driver

If you use Dial-Up Networking to access NetWare Connect servers, you can access data remotely, but you cannot control a computer remotely as you can with the NetWare Connect client software supplied by Novell.

Connecting to Shiva Remote Access Servers

You can connect a dial-up client to the Shiva LanRover or NetModem/E families of remote access servers without specially configuring Dial-Up Networking.

With a Windows 95 dial-up client, you can dial in to a Shiva remote access server and connect to IPX, NetBEUI, and TCP/IP services on a network. A dial-up client connected to a Shiva server can access any network resources that a computer on the local area network can, including all other computers running Windows 95, NetWare servers, electronic mail, client-server applications, and the Internet.

In addition to supporting all the capabilities of the Windows 95 dial-up client, Shiva remote access servers offer the following capabilities:

- Data compression
- Dial back
- Dynamic Host Configuration Protocol (DHCP) support for IP address assignments during TCP/IP dial-in
- Support for Security Dynamics ACE/Server and TACACS centralized authentication
- Integrated ISDN support
- NetWare bindery information

Configuring a Shiva Server for Windows 95 Dial-Up Clients

If you have a Shiva remote access server running on your network, you do not need to make any configuration changes to enable dial-up clients. Shiva remote access servers running release 3.5 and above are fully compatible with Windows 95 dial-up clients.

If you are installing a new Shiva remote access server, there are a few steps to configure it to support dial-up clients. You can configure all dial-up parameters for a Shiva remote access server with the Shiva Net Manager for a Windows-based application on a computer running Windows, Windows for Workgroups, or Windows 95, or with the Shiva Net Manager for Macintosh application. Shiva Net Manager for Windows 95 will be available shortly after the release of Windows 95.

Before configuring the Shiva remote access server for Windows 95 dial-up clients, you need to do the following:

- Ensure that you have properly installed the Shiva remote access server and connected it to an Ethernet or token-ring network.
- Connect your modem to the serial port of your LanRover and to the telephone line, or connect the telephone line directly to the LanRover/PLUS or NetModem/E with integrated modem.
- Install Shiva Net Manager for Windows on a computer that is attached to the Ethernet or token-ring network. Shiva Net Manager for Windows requires either IPX or TCP/IP on the personal computer.
- Make sure that dial-in access for a particular protocol or protocols is enabled.



To configure the Shiva remote access server with Shiva Net Manager for Windows 95

1. Run Shiva Net Manager by double-clicking the SNM icon, and then double-click the name of the Shiva remote access server you want to configure in the Shiva Net Manager Device List dialog box.
2. In the Shiva remote access server Configuration dialog box, click the General configuration page from the Configure menu.
3. Check the Dial-In function to enable it, and then check the protocols that you want to enable for Windows 95 Dial-Up Networking: IP, NetBEUI, or IPX.

The screenshot shows the 'Shiva_LanRoverE - LanRover/E 3.x Configuration' dialog box. The title bar includes the application name and standard window controls. Below the title bar, there is a 'Configure:' dropdown menu set to 'General'. The main area is divided into several sections:

- LanRover/E Name:** A text field containing 'Shiva_LanRoverE'.
- Protocols:** A group box containing three checked checkboxes: 'IP', 'NetBEUI', and 'IPX'. There are also unchecked checkboxes for 'AppleTalk' and 'LLC'.
- Functions:** A group box containing four checkboxes: 'Dial-In' (checked), 'Dial-Out' (unchecked), 'LAN-to-LAN Originate' (unchecked), and 'LAN-to-LAN Answer' (unchecked).
- Timeouts:** A group box containing three checkboxes, each followed by a text input field set to '0' and the word 'minutes':
 - Disconnect dial-in user if inactive for more than 0 minutes
 - Disconnect dial-out user if inactive for more than 0 minutes
 - Disconnect LAN-to-LAN link if inactive for more than 0 minutes
- Logging:** A group box containing a checked checkbox 'Internally log messages of priority' followed by a dropdown menu set to 'Info' and the text 'and higher'.
- Compression:** A group box containing a checked checkbox 'Enable compression for Dial-In and Lan-to-LAN connections'.

4. In the Configuration dialog box, click the Ports configuration page, and then check that all ports with modems are enabled and properly configured with modem strings.
5. If you are enabling TCP/IP dial-in, click the IP configuration page from the Configure menu, and then type the IP address of the Shiva remote access server.

The screenshot shows the 'Shiva_LanRoverE - LanRover/E 3.x Configuration' dialog box with the 'IP General' tab selected. The dialog is divided into several sections:

- Ethernet:**
 - IP address of device: 192.36.78.171
 - IP network mask: 255.255.255.0
 - IP broadcast address: 192.36.78.255
- General:**
 - IP address of default router: 192.36.78.14
 - IP address of name server: 192.36.78.25
 - IP address of time server: 192.36.78.25
 - No UDP checksums
 - Generate zero fill broadcast address
- IP Address Assignment:**
 - Dial-In address supplied by:
 - User on dial-in
 - User list
 - Port IP address
 - DHCP
 - Lease time: 2 hour(s)
 - Retain address on reconnect (Requires unique user name)
- BootP/TFTP:**
 - Always retrieve image and configuration from BootP server

6. If you are enabling NetBEUI dial-in on a token-ring network, click the Bridging configuration page from the Configure menu, and then type the ring numbers required for source routing.
7. To save your configuration, select the Set Configuration command from the Actions menu. You will need to create a user name and password for each dial-up user.



To store user names and password using the internal user list of the Shiva remote access server

1. In the Shiva Net Manager Device List dialog box, click the name of the Shiva remote access server for which you want to create a dial-up user list.
2. In the Security menu, click the Get User List command.

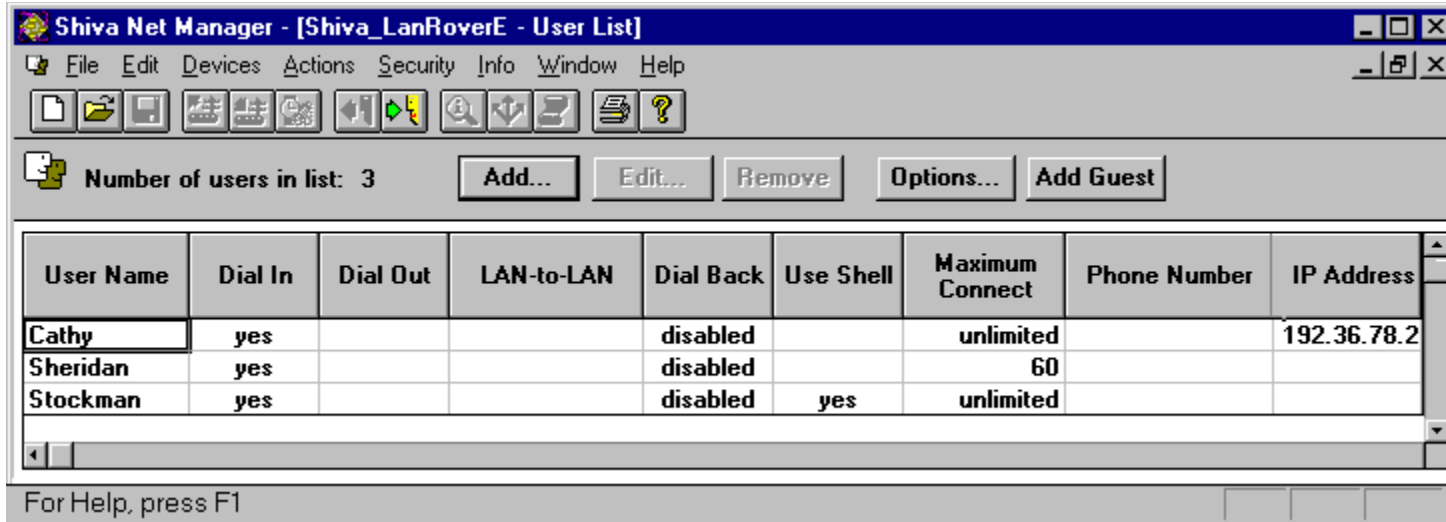

3. In the User List dialog box, click the Add button.
4. Type a user name and password for each dial-up user. Make sure that dial-up access is enabled for the user, and click OK.
5. Save the user list for the Shiva remote access server from the Security menu's Set User List command.

Assigning TCP/IP Address to Dial-Up Clients With Shiva Remote Access

To connect a dial-up client to TCP/IP network services, the client must have an IP address. Shiva remote access servers provide different ways to assign IP addresses to dial-up clients:

- You can assign a unique IP address to each Shiva remote access server port. Every time a user dials in to a Shiva remote access server port, the dial-up client determines the IP address of the port by using the Reverse Address Resolution Protocol (RARP).
- You can assign an IP address to every dial-up client. When a user dials in, the Shiva remote access server assigns the IP address based on the user name.
- A centralized Windows NT Dynamic Host Configuration Protocol (DHCP) server can tell the Shiva remote access server which IP address to assign to the dial-up client.
- You can assign an IP address to every dial-up client. When a user dials in, the Shiva remote access server assigns the IP address based on the user name.
- The remote user can tell the Shiva remote access server which IP address to use for the dial-up client. If a user tries to obtain an illegal IP address, the Shiva remote access server allows it, but the connection fails.

If you want the Shiva remote access server to assign IP addresses to dial-up clients, see the documentation for the server.

Security Options with Shiva Remote Access Servers

Shiva remote access servers provide several security options that prevent unauthorized access to your corporate network. You can choose the method, or combination of methods, that works best for your organization — from passwords to security devices from other vendors. Here are some of the methods that Shiva uses to provide a high level of security:

- **User lists.** Shiva remote access servers can store user names and passwords for controlling dial-up access to the remote access server. When you add users to the Shiva remote access server user list, they can dial in to the network, but they still need the appropriate access privileges to access any server or host on that network.
- **NetWare bindery.** If your organization uses NetWare bindery security features from Novell, you may not want to maintain an additional user list for a remote access server. You can use the NetWare bindery account database to provide centralized authentication services for dial-up access.
- **Security devices from other vendors.** You may use additional security devices to protect sensitive data on your corporate networks. Shiva remote access servers are compatible with most popular security devices, so you can evaluate and choose the security method that is appropriate for your organization.
- **Security Dynamics ACE/Server.** This security solution uses a UNIX server to maintain the centralized database of dial-up user privileges. Shiva remote access servers support ACE/Server authentication.
- **TACACS.** This is a centralized security solution that uses a UNIX server to maintain the centralized database of user privileges. Shiva remote access servers support authentication of dial-in users using TACACS.

Technical Notes On Dial-Up Networking

The Dial-up Networking client connects to a broad set of networks because support is included for IPX/SPX, NetBEUI, and TCP/IP network protocols, using PPP, NetWare Connect, or RAS for Windows NT or Windows for Workgroups over a modem, or SLIP over a modem to older UNIX networks.

Notes Because the Microsoft Dial-Up adapter driver is primarily an NDIS 3.1 network driver, it is important to note which protocols are bound to the Dial-Up driver (PPPMAC.VXD). Different protocols, when used in combination with other Dial-Up Networking connection choices, affect which features you can use.

When Dial-Up Networking tries to establish a connection, it first tries to use PPP by default, because PPP provides more flexibility than other connection protocols. Unlike SLIP, PPP provides the following:

- A method for encapsulating datagrams over serial links, based on the ISO High-level Data-Link Control (HDLC) protocol.
- A Link Control Protocol (LCP) for establishing, configuring, authenticating, and testing the data-link connection.
- A family of Network Control Protocols for establishing and configuring different Network Layer protocols.

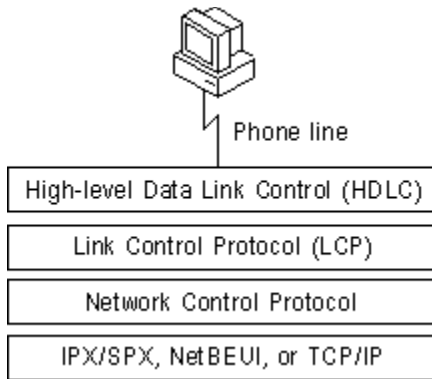

PPP is designed to work with a variety of hardware, including any asynchronous or synchronous, dedicated or dial-up, full-duplex bit-serial circuit. It can employ any common serial communications protocol, including EIA-232-E (formerly, RS-232-C), EIA-422, EIA423, EIA-530, and CCITT V.24 and V.35. PPP does not place any particular restriction on the type of signaling, type of transmission speed, or use of modem control signals.

PPP Dial-Up Sequence

When a user dials in to a PPP-compatible server, three things happen:

1. The Data Link Control Layer (HDLC) defines how data is encapsulated before transmission on the WAN. By providing a standard framing format, PPP ensures that various vendors' remote access solutions can communicate and distinguish data packets from each other. PPP uses HDLC framing for serial, ISDN, and X.25 data transfer.

The PPP Data Link Control layer is a slightly modified version of the HDLC layer. The HDLC format, extensively used by IBM and others for synchronous data transfer, was modified by adding a 16-bit protocol field that allows PPP to multiplex traffic for several Network Control Protocol layers. This encapsulation frame has a 16-bit checksum, but the size of this field can be negotiated.

2. Link Control Protocol (LCP) establishes, configures, and tests the integrity of the data-link connection. LCP also negotiates authentication and determines whether compression is enabled and which IP addresses will be used. When LCP negotiates authentication of protocols, it determines what level of security validation the remote access server can perform and what the server requires.

LCP can negotiate with any of these authentication protocols:

- Password Authentication Protocol (PAP) uses a two-way handshake for the peer to establish its identity. This handshake occurs only when the link is initially established. Using PAP, passwords are sent over the circuit in text format, which offers no protection from playback.
 - Shiva Password Authentication Protocol (SPAP) offers encryption of PAP passwords and Novell NetWare bindery access for user account information. When Windows 95 is set up for user-level security using a NetWare server account list, this is the security type used for remote access clients.
 - Challenge-Handshake Authentication Protocol (CHAP) periodically verifies the identity of the peer, using a three-way handshake. The authenticator sends a challenge message to the peer, which responds with a value using a one-way encryption. The authenticator then checks this response and, if the values match, the authentication is acknowledged; otherwise, the connection is ended. CHAP provides protection against playback attack, because the challenge value changes in every message. Because the password is never sent over the link, it is virtually impossible to learn it. CHAP allows different types of encryption algorithms to be used, such as DES (MS-CHAP) and MD5 (MD5-CHAP). Windows 95 doesn't support ongoing challenges with CHAP, but does implement MS-CHAP, as does Windows NT.
3. Network Control Protocols establish and configure different network protocol parameters. The type of Network Control Protocol that PPP selects depends on which protocol (NetBEUI, TCP/IP, or IPX) is being used to establish the Dial-Up Networking connection. Windows 95 supports the following:
 - NetBIOS Frames Control Protocol (NBF CP) is used to configure, enable, and disable the NetBEUI protocol modules on both ends of the link. NBF CP is a Microsoft-proposed protocol for NetBEUI configuration. NBF CP is currently in "draft" status with the Internet Engineering Task Force (IETF). Windows 95 provides implementations for the current draft of NBF CP (as of March 1994).
 - Internet Protocol Control Protocol (IPCP), defined in RFC 1332, is used to configure, enable, and disable IP Protocol modules at both ends of the link.
 - Internet Packet eXchange Control Protocol (IPXCP), defined in RFC 1552, is used to configure, enable, and disable IPX protocol modules on both ends of the link. IPXCP is widely implemented by PPP vendors.

PPP Log File

You can record how the PPP layers process a call by enabling the PPLOG file. This file contains some of the basic layers and points of any Dial-Up Networking session, and is especially useful for monitoring PPP sessions. It is recorded and stored in the Windows directory.



To enable PPP logging

1. In the Network option in Control Panel, double-click Microsoft Dial-Up Adapter in the list of installed network components.
2. Click the Advanced tab. In the Property list, click the option named Record A Log File, and in the Value list, click Yes. Then click OK.
3. Shut down and restart a computer for this option to take effect.

The following is sample content of a PPLOG.TXT file:

```
09-01-1994 18:14:22 - Remote access driver log opened.
09-01-1994 18:14:22 - Server type is PPP (Point to Point Protocol).
09-01-1994 18:14:22 - CCP : Layer initialized.
09-01-1994 18:14:22 - NBFCP : Layer initialized.
09-01-1994 18:14:22 - IPXCP : Layer initialized.
09-01-1994 18:14:22 - FSA : Encrypted Password required.
09-01-1994 18:14:22 - LCP : Layer initialized.
09-01-1994 18:14:22 - LCP : Will try to negotiate callback.
09-01-1994 18:14:22 - LCP : Layer started.
09-01-1994 18:14:22 - LCP : Received and accepted ACCM of 0.
```

Overview of Windows 95 Mobile Computing Features

Windows 95 eliminates many of the hardware and software configuration steps previously required when switching to or from a portable computer. Windows 95 uses hardware profiles to determine which drivers to load if the system hardware changes when you move to a new site. For more information, see [Devices](#).

Users can be productive away from the office by using the following Windows 95 mobile computing tools:

- Briefcase allows users to update documents on a portable computer with source documents on a desktop computer or network.
- Direct Cable Connection allows users to connect a portable computer to a desktop computer to synchronize files and share other resources.
- Microsoft Exchange provides remote access to electronic mail. For information, see [Electronic Mail and Microsoft Exchange](#).
- Microsoft Fax allows users to remotely send and receive faxes. For more information, see [Microsoft Fax](#).
- Deferred printing allows users to generate print jobs when a physical printer is not available. For more information, see [Printing and Fonts](#).

Other mobile computing tools, such as the following, help users manage a portable computer's limited battery power and disk space:

- With Advanced Power Management, users can use the battery indicator on the taskbar and a Suspend command on the Start menu to save power without turning off computer. For more information, see [Devices](#).
- With DriveSpace, users can free space on their portable computer's hard disk drive and floppy disks by compressing them. For more information, see [Disks and File Systems](#).
- With Microsoft Exchange, users can view the headers of mail messages before deciding whether to download, preventing unnecessary messages from taking up disk space.
- With Quick View, users can view the contents of a file in Windows Explorer by right-clicking a file icon. For information, see [Application Support](#).

Direct Cable Connection

With Direct Cable Connection, you can establish a direct serial or parallel cable connection between two computers in order to share the resources of the computer designated as the host. If the host is connected to a network, the guest computer can also access the network. For example, if you have a portable computer, you can use a cable to connect it to your work computer and network. To establish a local connection between two computers, you need a compatible serial or null-modem parallel cable.

Before you can transfer files from the host to the guest computer, the files must be in a shared directory, and File and Printer Sharing services for either Microsoft or NetWare networks must be enabled in the Network option in Control Panel. You can also apply share-level security to the shared files. For information, see [Logon, Browsing, and Resource Sharing](#), and [Security](#).

Note This capability is similar to that available with Interlink for MS-DOS 6.x, which allowed users to transfer data through the serial port between two personal computers.

Before you install and configure Direct Cable Connection, you need to decide:

- What remote access and network protocols do you need to install on the guest and host computers? They must both be running at least one common network protocol in order to connect. The host computer can act as a gateway to an IPX/SPX or NetBEUI network, but not to a TCP/IP network.
- What kind of cable do you need? Direct Cable Connection works with serial and parallel cables. For information, see [Direct Cable Connection](#).
- Do you want to assign a password to the host computer? If you assign a password on the host, all users connecting from the guest computer will be prompted for it. After connecting, the guest can access resources on the host computer according to the type of security applied to it, that is, user-level or share-level security.

Note After the host connects to the network, it can access shared resources on the guest computer.

Installing and Configuring Direct Cable Connection

To install Direct Cable Connection during Windows 95 Setup, you must choose Custom or Portable as the setup type. You can also install it after installing Windows 95.



To install Direct Cable Connection after Windows 95 installation

1. In the Add/Remove Programs icon in Control Panel, click the Windows Setup tab.
2. In the Components list, click Communications, and then click the Details button.
3. In the Communications dialog box, click Direct Cable Connection, and then click OK.

Windows 95 provides a Direct Cable Connection wizard for establishing the connection between two computers. The wizard runs when you open Direct Cable Connection for the first time. It allows you to designate one computer as the guest and the other as a host. Before you run the wizard, you need to install Direct Cable Connection on each computer and connect them with a null-modem serial or parallel cable.

For more information about setting up Direct Cable Connection, see online Help.

Cables Compatible with Direct Cable Connection

Windows 95 supports a serial null-modem standard (RS-232) cable and the following parallel cables:

- Standard or Basic 4-bit cable, including LapLink and InterLink cables available before 1992.
- Extended Capabilities Port (ECP) cable. This type of cable works on a computer with ECP-enabled parallel ports, which must be enabled in BIOS. This kind of parallel cable allows data to be transferred more quickly than a standard cable.
- Universal Cable Module (UCM) cable. This cable supports connecting different types of parallel ports. Using this cable between two ECP-enabled ports allows the fastest possible data transfer between two computers.

Parallel cables transmit data simultaneously over multiple lines, making it the faster of the two connection methods. Serial cables transmit data sequentially over one pair of wires, and are slower than parallel cables. Use a serial cable only if a parallel port is unavailable.

Using Briefcase for File Synchronization

If you can use a portable computer and a desktop computer, or you are connected to a network, you must constantly work to keep the files synchronized. Windows 95 Briefcase minimizes this task by keeping track of the relationships between files on two or more computers.

With Briefcase, you can do the following:

- Create a Briefcase folder
- Add files to Briefcase
- Check the status of files in Briefcase and their related files
- Update related files, either individually or all at once
- Split related files to maintain them separately

Windows 95 provides a set of OLE interfaces that allow applications to bind reconciliation handlers to it, track the contents of Briefcase, and define the outcome of any reconciliation on a class-by-class basis. For example, when both the file in Briefcase and its synchronized copy outside have changed, Windows 95 calls the appropriate reconciliation handler to merge the two files. This could be handy when several users are simultaneously updating one large document.

Creating and Configuring a Briefcase

Windows 95 automatically configures Briefcase and installs it on your Windows 95 desktop if you choose it during Custom Setup of Windows 95, or if you choose the Portable setup type. If you do not choose either of these Setup options, you can install Briefcase afterward in the Add/Remove Programs option in Control Panel.



To install Briefcase after Windows 95 installation

1. In Control Panel, double-click the Add/Remove Programs icon.
2. Click the Windows Setup tab, and in the Components list click Accessories, and then click the Details button.
3. In the Accessories dialog box, click Briefcase, and then click OK.

If you install Briefcase, it appears as an icon on your Windows 95 desktop. To run Briefcase, double-click its icon.

Tip You can use Briefcase to synchronize files between a portable computer running Windows 95 and a desktop computer running Windows NT 3.5.

Updating Files with Briefcase

When you update files by using Briefcase, Windows 95 automatically replaces unmodified files with modified files. If both files have changed, Windows 95 calls the appropriate application (if available) to merge the disparate files. Before you leave the office, you can copy files from your desktop to Briefcase, and then load Briefcase onto your portable computer. When you return, Briefcase will automatically update files when you dock your portable computer if you are using a Plug and Play BIOS docking station.

For information about updating files using Briefcase and a floppy disk, see Windows 95 online Help.

Tip For faster editing, you can move Briefcase files to a hard disk on a second computer; to do this, drag the files from the floppy disk to the second computer's hard disk. When you have finished editing the files on the desktop computer, choose Update All from Briefcase on the floppy disk. When you return to the original computer, choose Update again to replace the unmodified files on this first computer.

Instead of using a floppy disk with Briefcase, you can use Direct Cable Connection to connect two computers running Windows 95, and then use Briefcase to synchronize their files. For example, you can connect your portable computer to your home or office computer with Direct Cable Connection, and then update the desktop computer files to match the portable files.

For more information about Direct Cable Connection, see [Direct Cable Connection](#).



To update files using Briefcase and two connected computers

1. Copy to Briefcase any files or folders you want to work on.
2. Make changes to the files either in their original location or in Briefcase.
3. Connect the computers by using Direct Cable Connection, and then double-click My Briefcase.
4. Click the files you want to update.
5. On the Briefcase menu, click Update All or Update Selection.

Note You can also use Briefcase to synchronize files between a portable computer and a network if the portable computer has a network connection.

When you open the Briefcase folder, you can check the status of any file in Briefcase to find out if it has been synchronized with its original. You can also split files from their originals if you decide to maintain them separately. For more information on these topics, see online Help.

Tip To find the copy of a file that is outside Briefcase, click Find Original in the Update Status dialog box.

Troubleshooting Dial-Up Networking

This section describes problems which you may encounter in using Dial-Up Networking and how to resolve them. Windows 95 provides a troubleshooting aid for Dial-Up Networking in online Help. Try using the online Help before trying the troubleshooting steps included in this section.

You can monitor any Dial-Up Networking session for possible problems by enabling the Record a Log File option. This produces a PPPLOG.TXT file in the Windows directory, which you can reference to find out the cause of a problem.

You cannot access the Dial-Up Networking server because a user name is not valid.

In the properties for the dial-up server, verify that the user name is in the list of users that are allowed access.



To set Dial-Up Networking Server to allow caller access options

1. In Dial-Up Networking, click the Connections menu, and then click Dial Up Server.
2. In the the Dial-Up Server properties, click Allow Caller Access, if this is not already selected, and then view the User name list to ensure the user's name appears.

The User name list appears only if you have chosen user-level security for the dial-up server. The type of security is selected in the Network option in Control Panel.

If the dial-up client is also running File and Printer Services for NetWare Networks, the File and Printer Sharing service automatically becomes the default server, but it cannot receive the information needed to find the remote servers.

You cannot access remote NetWare servers when making a dial-up connection.

Disable File and Printer Sharing Service for NetWare Networks when you make the dial-up connection.

Software compression does not work.

Check the settings for the dial-up server type and software compression.



To verify dial-up server and compression options in Dial Up Networking

1. In the Connections menu, click Dial-Up Server.
2. Click the Server Type button and verify that the correct type of dial-up server is selected.
3. Check that Enable Software Compression is selected. Compression will occur only if the dial-up client and server have enabled it.

The modem is dialing but not connecting.

- Check the modem configuration; change the configuration if necessary.
- Verify all parameters, such as access codes, area code, and country code.
- Try choosing the driver for Generic Modem Drivers.
- If you are using an external modem, check the cable and verify that it is connected correctly.
- Check the COM port configuration in Device Manager.

For more information, see the troubleshooting section in [Modems and Communications Tools](#).

Dial-Up Networking Server is not answering incoming calls.

- Disable Allow Caller Access and shut down the computer. Turn off the computer to reset the COM port. If the modem is external, turn off the modem. Turn the computer back on and reconfigure the Dial-Up Networking server, and then try again.
- If these steps fail, disable Allow Caller Access and see if any modem software can manually answer the incoming call.
- If you are using an external modem, check the cable and verify that it is connected correctly.
- If you are using an internal modem with a nonstandard IRQ selection, use Device Manager to check the IRQ setting for the COM port and change it if necessary.
- Try choosing the Generic Modem Drivers on the dial-up server.

The password for the Dial-Up Networking server is stored in the RNA.PWL file. However, simply deleting this file or removing and reinstalling Dial-Up Networking may not remove the password. If you

set the Dial-Up Networking server to monitor for calls, then delete the RNA.PWL file, the password is not removed because it is stored in memory. If you shut down Windows 95 at this point, the RNA.PWL file is recreated with the password in memory.



To replace a forgotten password in a Dial-Up Networking Server

1. Disable Allow Caller Access, and then shut down and restart Windows 95.
2. Delete the RNA.PWL file, and then restart the Dial-Up Networking.

Note When you first connect to the Dial-Up Networking server, an error message states that the password file is missing or corrupt for every modem device you have installed. If you have any null modem devices installed (for example, when you run Direct Cable Connection it installs a modem device for every COM and LPT port you have), this error message also appears.

Introduction

This chapter describes how to install and sign up for an account with The Microsoft Network. This chapter also briefly describes the features of this new online service from Microsoft.

- [The Microsoft Network: The Basics](#)
- [The Microsoft Network: The Issues](#)
- [Becoming a Member of The Microsoft Network](#)
- [Security for The Microsoft Network](#)
- [Navigating The Microsoft Network](#)
 - [MSN Central](#)
 - [Windows Explorer and The Microsoft Network](#)
 - [Go Commands](#)
- [Using Bulletin Boards](#)
 - [Bulletin Board File Libraries](#)
 - [Chat Rooms](#)
- [Using Microsoft Exchange with The Microsoft Network](#)
- [Billing](#)
- [Becoming an Independent Content Provider \(ICP\)](#)

The Microsoft Network: The Basics

For anyone with a modem and phone line, The Microsoft Network offers access at any time to the rapidly expanding world of electronic information and communication. With The Microsoft Network, users can conduct business transactions, communicate with individuals and organizations around the world, and find out information on subjects they're interested in — all from the Windows 95 desktop.

The following are benefits of signing up and using The Microsoft Network.

Minimal setup requirements.

A connection to The Microsoft Network is built into Windows 95. If users already have a modem and phone line, all they have to do is install The Microsoft Network during or after Setup, and click The icon on the desktop to connect to The Microsoft Network and become a member. After setting up an account, users can connect to The Microsoft Network by clicking its icon.

Familiar user interface.

With a user interface consistent with Windows 95 and a navigational tool similar to the Windows Explorer, users will find it easy to navigate services in The Microsoft Network. Users can create Windows 95 shortcuts to specific areas within The Microsoft Network and store those shortcuts on the desktop or any other folder in My Computer. Actions such as downloading files are as simple as using drag and drop to copy the files. And users can open Microsoft Exchange within The Microsoft Network to send and receive mail.

Multitasking.

The Microsoft Network takes advantage of the multitasking and multithreaded design in Windows 95 so that several different tasks in The Microsoft Network can run at the same time. For example, while a file is downloading, users can browse, read electronic mail, participate in a chat room, or do anything else on The Microsoft Network.

Worldwide access.

Local dial-up access is available to The Microsoft Network in over 40 countries, and The Microsoft Network application will be available in many different languages. In the United States, nearly 100 percent of users can access a network Point of Presence (POP) server; outside of the United States, between 60 percent and 100 percent of users will have access by a local phone call, depending on the country.

In the release with Windows 95, The Microsoft Network offers the following features.

Electronic mail.

With Microsoft Exchange, users can send and receive electronic mail to and from other members of The Microsoft Network, or anyone with an electronic mailbox on the Internet.

Bulletin boards.

The Microsoft Network provides bulletin boards where users can join in-depth discussions on a variety of topics, including hardware or software from computer companies.

Chat rooms.

By participating in chat sessions, users can converse in real time with other members of The Microsoft Network by sending and receiving messages. After users find a chat room with a discussion that interests them, they can observe the conversation or send a comment for other members to see immediately.

File libraries.

The Microsoft Network allows users to easily connect to file libraries to download graphics, software, product support information, and articles.

The Internet.

With Microsoft Exchange, users can send mail to other people on the Internet, and post and reply to messages in Internet newsgroups in the same way as users would on other bulletin boards.

Users can also obtain an Internet account by using the Microsoft Plus! Internet Signup wizard, which guides Windows 95 users through the process of obtaining an Internet account. This provides the following Internet features:

- Internet Shortcuts, which allow users to create a shortcut in Windows 95 to an Internet resource.
- Internet Explorer, which allows users to browse the World Wide Web, FTP, and Gopher sites. Its full support for OLE allows users to drag and drop World Wide Web pages and links between the Internet Explorer, the Windows 95 desktop, and any other OLE-enabled application.

Microsoft product information.

The Microsoft Network provides users with the latest technical and support information in the following forums:

- Frequently Asked Questions provides quick answers to common technical questions.
- Microsoft Knowledge Base contains more than 50,000 detailed articles with technical information about Microsoft products, bug and fix lists, documentation errors, and answers to commonly asked technical support questions.
- Microsoft Software Library contains hundreds of free software add-ons, bug fixes, peripheral drivers, software updates, and programming aids for easy downloading at the user's convenience.
- Microsoft-Facilitated Member-to-Member Bulletin Boards provide advice and answers fast from other software users.

Information services.

Information services that provide news, sports, stock and weather reports, product and product support information, and special-interest group information are accessible from The Microsoft Network.

Independent content providers (ICP).

By becoming an ICP on The Microsoft Network, a company can sell products and services in a worldwide electronic marketplace that is accessible from the Windows 95 desktop.

The Microsoft Network: The Issues

Before installing The Microsoft Network, consider the following issues:

- When users double-click The Microsoft Network icon to sign up for an account, The Microsoft Network automatically dials a toll-free number to download price and billing information. After users fill out the billing information, The Microsoft Network automatically dials a second local number to provide access to services on The Microsoft Network.
- If users have problems connecting, first try to resolve them by using the signup troubleshooting information in online Help. One troubleshooting topic tells you how to change the access number for a location.
If problems persist with signup, contact The Microsoft Network product support using the telephone numbers in online Help in The Microsoft Network or in **msn.hlp** in the Windows directory. If problems persist with using The Microsoft Network, post a message in the bulletin board in Member Assistance in The Microsoft Network.
- Certain types of PBXs restrict users from accessing an outside telephone line or from dialing toll-free numbers, both of which are required to sign up for The Microsoft Network. If the user tries to sign up from such a PBX, the user might see the error message “No carrier detected,” or might hear a busy signal or operator message. To correct this problem, you must configure the PBX to allow users to dial toll-free numbers and access an outside line.
- If you need to create more than one account with The Microsoft Network on a single computer, you must run Signup for each account. Click Start, click Run, and then type **signup.exe** to run the Signup utility.
- Members should invent secure passwords to protect access to their accounts. They can use the same passwords as their network logon passwords or create a different one. It is not possible to pass through an electronic mail name and password from the Windows 95 Registry. Members who want to can invent a nickname that protects their identities on The Microsoft Network.
- If your company decides to become an ICP on The Microsoft Network, you will need to provide a forum manager for your service area. Microsoft provides information about the responsibilities of a forum manager with other information about becoming an ICP. For more information, see [Becoming an Independent Content Provider \(ICP\)](#).

Becoming a Member of The Microsoft Network

Becoming a member of The Microsoft Network requires two easy steps:

- Installing The Microsoft Network during or after Windows 95 Setup
- Clicking The Microsoft Network icon on the Windows 95 desktop to start signup

The easiest way to install The Microsoft Network is to choose it in the Get Connected dialog box during Windows 95 Setup. Users can install it after Setup by using the Control Panel.



To install The Microsoft Network after Window 95 Setup

1. In Control Panel, double-click the Add/Remove Programs icon.
2. Click the Windows Setup tab, and in the Components list click The Microsoft Network, and then click OK.



To become a member of The Microsoft Network

1. Double-click The Microsoft Network icon on the Windows 95 desktop.
2. In The Microsoft Network dialog box, click OK.
3. The next signup box displays the three steps for signing up with The Microsoft Network. Click each button and type the appropriate information.
4. In the user information signup box, type your name, address, and phone number.
5. In the billing information signup box, type your payment method (credit card name), credit card number, and expiration date.

After users connect for the first time, they should click Member Assistance on MSN Central to read about the rules for participating in The Microsoft Network.

The Microsoft Network

Security for The Microsoft Network

The Microsoft Network security service authenticates and validates multiple members simultaneously logging on and off. The security service grants or denies members, requests to log on and to use different areas of the service based on the rights assigned by The Microsoft Network database.

In addition, The Microsoft Network establishes and manages policies that govern what actions members can perform. This ensures the confidentiality of data and the value of transactions in The Microsoft Network.

The member ID users choose when they sign up must be unique to The Microsoft Network. After a membership is terminated, The Microsoft Network does not reissue that member's member ID for 12 months to prevent confusion.

The Microsoft Network maintains a Client Negation record, which is a list of members who have been denied access for reasons of bad credit, repeated violations of The Microsoft Network rules, and so on. Members can also be excluded from individual forums for violations of rules. When users sign up, The Microsoft Network accounts database verifies that they are not on this list before approving their member IDs and passwords.

Navigating The Microsoft Network

Viewing information on The Microsoft Network is as easy as browsing through a local area network in Windows 95, because users use the same navigational tools. To move from service to service within The Microsoft Network, users double-click icons or use Windows Explorer.

Users can navigate to any of the services offered in a forum in many different ways, including the following:

- Double-clicking an icon for the service users want.
- Right-clicking an icon to open the Windows Explorer menu (context menu), and clicking Open.
- Double-clicking a shortcut in a Windows 95 directory, in an electronic mail message, or in a bulletin board in The Microsoft Network. For more information, see [Shortcuts](#).
- Using the Go command. For more information, see [Go Commands](#).
- Double-clicking an icon in Favorite Places. For more information, see [Favorite Places](#).

The Microsoft Network structures the large body of information it presents to users into a content tree. The content tree is organized so that broad categories of information are stored at the highest level, with folders at successive levels containing progressively more detailed information. The top folder in the content tree is called the Categories folder, and the contents of this folder will rarely, if ever, change.

The content tree enables users to quickly find services within The Microsoft Network and, based on a user's membership privileges, to view, subscribe, or access specific information, applications, and services.

All the services and content provided by The Microsoft Network are stored in distributed SQL databases in a Microsoft-owned data center. Initially, The Microsoft Network will have a single data center near Seattle, Washington, but Microsoft plans to provide several more data centers around the world.

The primary way to enter The Microsoft Network is through MSN Central, which is the highest level of the content tree. MSN Central appears when users click the icon for The Microsoft Network. From MSN Central, users can choose the following services or tools.

Home Page Icon	Description
MSN Today	Tells users what new information has been added to the service or what special events are occurring on The Microsoft Network specifically for that day. Users can click on the corresponding icons to go directly to the services.
Electronic Mail	Starts Microsoft Exchange, allowing users to send mail to and receive mail from members of The Microsoft Network, other users of a Microsoft Mail workgroup postoffice, and people on the Internet.
Favorite Places	Opens a Favorite Places folder where users can store shortcuts to their favorite bulletin boards and chat rooms.
Member Assistance	Contains a folder with rules and behavior guidelines, membership agreement, information about The Microsoft Network for new members, practice chats and bulletin boards, The Microsoft Network customer support, and other information.
Categories	Contains all the icons for the different forums offered by The Microsoft Network, such as Arts and Entertainment, Sports, and so on. A forum is a collection of services that include bulletin boards, chat rooms, and others. Clicking a forum icon opens a folder where icons for all services within the forum are displayed, including: <ul style="list-style-type: none">• Bulletin boards to read and post messages• Chats to carry on live conversations• Kiosks to locate the subject matter of a forum and identify the forum manager• File libraries to download files

Windows Explorer and The Microsoft Network

Windows Explorer is a powerful way to navigate The Microsoft Network content tree. A Windows Explorer window in The Microsoft Network contains folders and works the same as any Windows Explorer window in Windows 95 except in the following ways:

- The files are read-only. Users can't create, edit, or drag and drop files in Windows Explorer in The Microsoft Network.
- Windows Explorer by default does not open a new window for each folder that a user opens because MSN users typically open numerous folders while exploring MSN, which can reduce available system resources. You can change this option to open a separate window for each folder in Folder properties, which can be opened from the Options item in the View menu in Windows Explorer.



To use Windows Explorer in The Microsoft Network

- Right-click a folder or icon, and then click Explore.

In Windows Explorer, users can find out the properties of a forum or folder, including the Name, Category, Rating, Go words, and price. A forum manager for The Microsoft Network can decide which properties can function as *key words*. Key words are a means of tagging content so that users can search for information within the service.



To view the properties for each forum

- Right-click the icon for a forum or folder in it, and then click Properties.

The Microsoft Network

Navigating The Microsoft Network

Windows Explorer and The Microsoft Network

Shortcuts

Shortcuts immediately take users to specific areas within The Microsoft Network. Users can drag and drop the shortcut to any Windows 95 folder, a word processing file, a bulletin board message, or any other OLE-compatible application. Double-clicking the shortcut will launch The Microsoft Network, log users on, and take users to the service that their shortcut referred to.

For information on creating shortcuts in Windows 95, see online Help.

The Microsoft Network

Navigating The Microsoft Network

Windows Explorer and The Microsoft Network

Favorite Places

Favorite Places are similar to shortcuts in Windows 95, but are a special feature of The Microsoft Network. Users can use Windows Explorer to add a Favorite Places icon for a folder or forum to the Favorite Places folder in MSN Central. Unlike shortcuts, users can use Favorite Places icons only for services in The Microsoft Network, and can place them only in the Favorite Places folder.



To add a service to the Favorite Places folder

- From The Microsoft Network toolbar, click an icon, and then click the Add to Favorite Places button.

-Or -

Right-click an icon, and click Add To Favorite Places.

Go Commands

Users can quickly navigate to a specific service if users know its *Go* word, a unique identifier of a service in The Microsoft Network. Go words are defined in two places: in a Kiosk or in the properties dialog box for a service.



To determine a service's Go word

1. Right-click an icon for a specific service, and in the Windows Explorer menu, click Properties.
2. In Properties for that service, click the General tab. The Go word appears at the top of the General properties dialog box.



To navigate to a service using a Go command

1. From the Edit menu in the window for any service, point to the Go To option, and then click Other Location.
2. In the Go To Service dialog box, type the Go word, and then click OK.

Note If users don't know the exact name of a service or subject that users are looking for, users can use the Find option from the Start menu in Windows 95, or in the File menu in Windows Explorer in The Microsoft Network. With the Find Command, users can specify search criteria such as a specific name or topic for a particular service. For more information, see online Help.

Using Bulletin Boards

A bulletin board provides a place to exchange messages. Most bulletin boards are public, which means any member of The Microsoft Network can read them. Each bulletin board has a topic, such as scuba diving, computer graphics, or current events. Users post messages about the topics to do the following:

- Ask or answer questions
- Offer opinions, ideas, or suggestions
- Share facts and exchange information
- Distribute files for other people to copy to their computers

A thread is a collection of messages users can organize chronologically or hierarchically to reflect the flow of the discussion. Messages appear in a bulletin board in three possible default views:

- List View lists all messages in the order they were sent to the bulletin board.
- Conversation View lists all original messages and their replies and is organized according to a conversation thread. To read replies, click the + icon; to read individual messages, double-click a message.
- Attached Files View lists only those messages with attached files. This is an effective way of seeing information that pertains to files rather than messages.

Message views can be further sorted in each bulletin board according to their subject, author, size, or date.



To navigate through The Microsoft Network content tree to a bulletin board

1. In MSN Central, click Categories.
2. In the Categories window, choose a topic by double-clicking its icon.
3. Continue to double-click icons to select subcategories until you are in the forum containing the bulletin board that interests you.
4. In the forum window, double-click the bulletin board folder to see current messages.



To change the view of messages

- In the bulletin board, click the View menu, and then click List, Conversation, or Attached Files.



To sort messages within a bulletin board

- In the bulletin board, click the Subject, Author, Size, or Date button beneath the toolbar to sort accordingly.

Bulletin Board File Libraries

File libraries are read-only bulletin boards. This means that only an ICP who owns the bulletin board can post messages and files there. You can read and download files in file libraries and files attached to messages in file libraries in the same way you would in a standard bulletin board. File attachments can be graphics, software, articles, product support information, and so on.

Before users download a file, they can view its size, its price, and the length of time it will take to download. When users download it, they specify the file's destination on the hard disk in the File Transfer Status dialog box.

File Transfer Status is a utility that mediates file movement between the server and the client. It allows users to view and control how the file downloads. File Transfer Status is active whenever a file is placed in the transfer queue by an application such as a bulletin board. File Transfer Status can transfer files in the background while users continue to browse through The Microsoft Network.



To download an attached file

1. Open a message with an attachment, right-click the attachment's icon, point to File Object, and then click Properties.
2. In Properties for that message, examine the file's size, download time, price, and whether the forum manager has approved the file for downloading, and then click OK.
3. In the message, click the File menu, and then click Save As.
4. In the Save As dialog box, click the folder on the hard disk where you want the file to be saved, and then click Open. This adds the file to the queue of files to be downloaded or starts the downloading process if it is the first file to be selected for downloading.

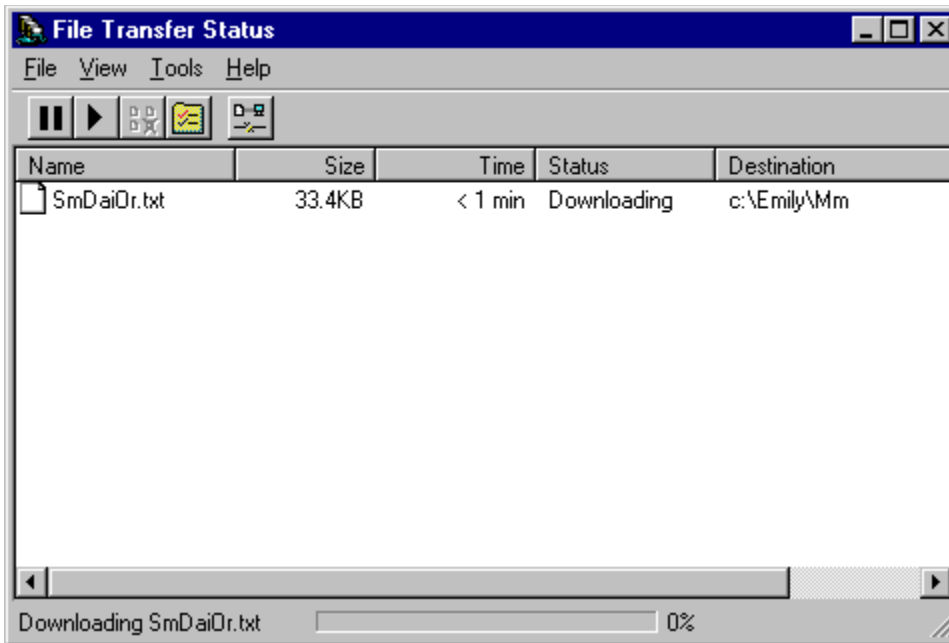

When files are queued, File Transfer Status checks for error conditions, such as insufficient space on the hard disk or invalid destination, and provides a corresponding error message. File Transfer Status then provides an opportunity to fix an error before the file is transferred. In the File Transfer Status window, the percentage of file downloaded, the time remaining, and the file's destination are displayed.

If users are downloading files that were attached using a file-compression program, File Transfer Status detects this and automatically decompresses them if the option named Automatically Decompress Files is checked in the File Transfer Options dialog box. This dialog box can be opened by clicking the Options item in the Tool menu in File Transfer Status.

A chat room allows users to carry on a live conversation (a chat) with other members of The Microsoft Network. A chat session on The Microsoft Network is similar to a conference call. However, instead of speaking words, users type them and they are displayed on-screen by The Microsoft Network for other people to read. To participate in a chat session, users should know the following:

- Each member in the chat session is either a participant or spectator according to how the host defines the participation rules. A chat session might have one or more hosts. To become a host, you have to be a designated owner of the chat.
- A host can control the participation rights of members in a conversation. The host uses the Host Control dialog box to change the status of a member from a participant to a spectator and vice versa.
- There are several types of conversations, from one-on-one conversations to large “talk shows” in which there are a few participants and numerous spectators, to general purpose, multiple-member conversations.
- To join and send messages in a chat room, the conversation must not have exceeded its capacity, that is, the maximum number of members allowed in the conversation, and users must have the necessary security privileges.
- Before users contribute to the conversation, they can observe it for a while to see if they’d like to join in. When they’re ready and if they have participant status, they can send a question, answer, or comment to the other members.
- Users can view information about a member in the Member Properties option under the View menu, if the member completed a member profile in Microsoft Exchange. For more information, see [Using Microsoft Exchange with The Microsoft Network](#).
- Users can download a conversation history, which is a record of all messages sent to the conversation from the time a participant joined it.



To join a chat room

1. In a forum’s window, double-click the Chat icon.
The Microsoft Network informs other participants that you have joined the conversation.
2. Type a message in the lower box and then click Send.
Pressing ENTER also sends text and, therefore, cannot be used within a message. However, you can press CTRL+ENTER to insert a carriage return in your message.
3. To exit, click the File menu, and then click Exit.

Using Microsoft Exchange with The Microsoft Network

The Microsoft Network has been integrated with the Microsoft Exchange client that is provided with Windows 95. All electronic mail messages sent to or from other members of The Microsoft Network appear in the same mailbox as messages from other electronic mail (such as LAN mail), or information services such as CompuServe® or the Internet.

All features of Microsoft Exchange are available to users when users run The Microsoft Network. Because both Microsoft Exchange and The Microsoft Network support binary file transfers and OLE, users can attach spreadsheets, graphics files, word processing documents, or almost any other kind of electronic file to a mail message.

Before users send and receive mail in The Microsoft Network, they must complete the following steps:

- Install and configure Microsoft Exchange, as described in [Electronic Mail and Microsoft Exchange](#)
- Connect to The Microsoft Network



To send or receive mail within The Microsoft Network

- In MSN Central, click E-mail to open Microsoft Exchange.

Note When users sign up for The Microsoft Network, their primary Microsoft Exchange profile will be updated so that The Microsoft Network is included as both an information service and an address book provider. Users can send and receive mail over The Microsoft Network without further configuring Microsoft Exchange or The Microsoft Network.



To send mail on the Internet

1. In MSN Central, click E-mail.
2. Click Compose, and then click New Message.
3. In the To box, specify an Internet address.

An Internet address consists of a user name and a DNS domain name, separated by the @ character. In the following example, **jim256** is the user name and **msn.com** is the domain:

`jim256@msn.com`

In the next example, **rks** is the user name and **seas.ucla.edu** is the domain:

`rks@seas.ucla.edu`

For more information about DNS domain names, see [Internet Access](#).

Mail from other users on the Internet appears in the Microsoft Exchange Inbox along with other messages.



To download mail from The Microsoft Network at startup of Microsoft Exchange

1. In Control Panel, double-click the Mail And Fax option.
2. In the Microsoft Exchange Settings Properties, click The Microsoft Network Online Service, and then click Properties.
3. In Transport properties, click the option named Download Mail When E-Mail Starts Up From MSN.

As a result of this procedure, The Microsoft Network connection box will be displayed every time users run The Microsoft Network. Users can cancel the connection and choose to download their mail from The Microsoft Network at a later time from within Windows 95 or from within The Microsoft Network.



To download mail from The Microsoft Network after Microsoft Exchange startup

- In Microsoft Exchange, click the Tools menu, and point to Connect To, and then click The Microsoft Network.

The Microsoft Network maintains an address book on The Microsoft Network servers that includes the name and electronic mail address of each member of The Microsoft Network. Users can access the

address book in Microsoft Exchange, or in the Member Assistance section of The Microsoft Network. The Microsoft Network address book is available only when users are connected to The Microsoft Network because it is too large to copy to a local computer.

The Microsoft Network provides separate address books for each major region in the United States, Europe, Australia, and other countries. All members can access all of these address books. All address books appear in the list of address books in the Microsoft Exchange Address Book window. For more information about using address books, see [Electronic Mail and Microsoft Exchange](#).



To display member information

1. In Microsoft Exchange, open The Microsoft Network address book, and then double-click a member's name.
2. In the User Information dialog box, view information about the member, such as city, birth date, comments, and so on.

The Microsoft Network

Billing

The Microsoft Network automatically charges users a monthly fee for using its services and a monthly base fee for additional blocks of time for the subscription services that users choose. If users spend time connected to a service beyond the allotted number of minutes they purchase with a subscription, The Microsoft Network assesses them a usage charge.

For example, a subscription to Forum XYZ might give users up to 20 minutes of connect time per month. Users will be charged an additional fee for the time they spend online in excess of 20 minutes.

Before users download a file, the Microsoft Network gives users information about whether there is a fee for copying it. If users download a file that has a fee, they will see the filename and the charge for downloading it.

All charges appear in a billing statement, which shows a user's current balance and all charges to the account by date. Payments and credits are shown as negative values. If there is a tax on any charge, it is figured automatically and included in the total. Users will be billed monthly; the billing date corresponds to the date they signed up for The Microsoft Network.

For more information about billing, see online Help in The Microsoft Network.

The Microsoft Network

Becoming an Independent Content Provider (ICP)

By becoming an ICP, companies can sell products and services in a worldwide electronic marketplace that is accessible from the Windows 95 desktop.

ICPs conduct business on The Microsoft Network on a transaction basis and retain the majority of the revenues from these transactions. ICPs aren't limited in the ways in which they realize revenues for their services. Variable revenue and pricing models such as subscriptions, online transactions, advertising subsidies, and ticketed events are available at the provider's discretion. Providers Transactions can be of the following types:

- Electronic files that can be downloaded
- Chat rooms with cover charges
- Forums with cover charges
- Monthly subscription fees for certain areas of a forum
- Sales of advertising and sponsorships

To obtain information about becoming an ICP, in the United States call (800) 4MSNFAX or (800) 467-6329. From outside the U.S., call (908) 885-6439. You will receive by fax a summary of The Microsoft Network, a guide to formatting your business proposal, and a nondisclosure agreement. To receive this information by mail, please write:

The Microsoft Network
Department MSN19
One Microsoft Way
Redmond, WA 98052-6399

Introduction

This chapter describes how to configure Windows 95 to access the Internet and offers some basic tips for browsing and accessing information on the Internet.

- Internet Access: The Basics
- Connecting to the Internet
 - Installing and Configuring a Modem
 - Obtaining an Internet Account
 - Internet Access Providers Successfully Tested with Windows 95
 - Installing TCP/IP
 - Setting the Domain Name System Server and IP Addresses
 - Making a Dial-Up Networking Connection
 - Technical Notes for IP address on TCP/IP Networks
- Navigating the Internet
 - Using Microsoft TCP/IP Utilities
 - Using FTP to Browse and Download Files
 - Downloading Files with FTP
 - Using Windows 95 Telnet
 - Browsing the Internet with Public Domain Tools
- Troubleshooting Internet Connections

Internet Access: The Basics

The Internet is a worldwide collection of networks and gateways linked, in most cases, with the TCP/IP suite of protocols. The Internet allows a broad spectrum of business people, academics, government users, and others to exchange ideas and information in a new way. Windows 95 offers you three ways to connect to the Internet:

- You can join The Microsoft Network online service from the Windows 95 desktop to send and receive mail on the Internet and access Internet newsgroups. For more information, see [The Microsoft Network](#).
- You can install TCP/IP and Dial-Up Networking — both of which are provided with Windows 95 — to connect to Internet access providers. You connect to an access provider by using Dial-Up Networking to dial in to their PPP or SLIP servers, which are directly connected to the Internet.
- You can install TCP/IP and a network adapter so that you can connect to a company's network server that is directly connected to the Internet.

Windows 95 supports all the protocols you need to connect to an Internet access provider, including a 32-bit implementation of TCP/IP, plus PPP or SLIP. In addition, Windows 95 provides FTP and Telnet clients, which can be used to browse the Internet and download files from Internet servers.

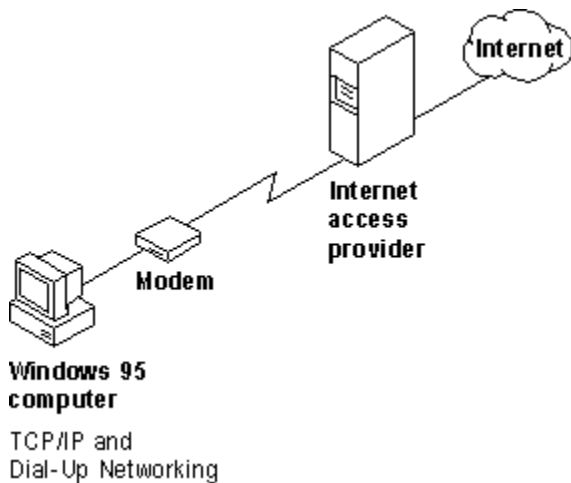

Connecting to the Internet.

To connect a computer running Windows 95 to an Internet access provider, you need to do the following:

- Obtain an Internet account with an Internet access provider. This is provided automatically if your company has a direct connection to the Internet.
- Install TCP/IP and Dial-Up Networking, and make sure TCP/IP is bound to the Microsoft Dial-Up adapter or a network adapter.
- Install a modem (if you dial in to the Internet) or a network adapter (if you have a direct network connection to the Internet).
- Define a Dial-Up Networking connection to an Internet access provider and define IP address information for each connection, or for your network adapter, if required.

For more information about how to do these tasks, see [Connecting to the Internet](#).

Before you connect to the Internet, you need to decide what kinds of information you want to provide or exchange. The most common tools for finding and exchanging information and the most common sources of information are described briefly in the following list and in more detail in [Navigating the Internet](#).

Sending and receiving mail.

You can send and receive mail to other individuals on the Internet or join an Internet mailing list. There are servers around the world that maintain and manage Internet mailing list communities. To send and

receive mail on the Internet, you need to run an electronic mail application, a Simple Mail Transport Protocol (SMTP) client, and connect to a SMTP server. You should ask your Internet access provider if they provide this support. After you have an electronic mail account, you can join a mailing list by sending an electronic mail message to a particular mailing list server.

USENET newsgroups.

Newsgroup servers, supporting Net News Transport Protocol (NNTP), share information and commentary on defined topics. Each newsgroup is a bulletin board where members post and reply to messages. To connect to a newsgroup, you need the following:

- Access to an NNTP server
- A newsgroup account provided by an Internet access provider
- An NNTP reader (an application that allows you to view newsgroup information), which is available commercially or as shareware from many Internet sites

Searching the Internet.

A variety of tools are available to help you find the information you need on the Internet. Many Internet access providers offer some of these tools, which include the following:

- Web browsers are multifaceted tools that allow you to dynamically view the World Wide Web (WWW), a network of servers that uses hypertext links to find and access files. A browser allows you to view documents on servers around the world without having to manually type each location. Most currently available browsers include versions of FTP, Telnet, Gopher, Mail and WAIS, giving you wide-ranging capabilities to search, connect, and download information on the Internet.
- File transfer protocol (FTP) is a file-sharing protocol for finding and connecting to servers, and then transferring text and binary files between a host computer and a computer. Archie is a database and a system for locating files on FTP servers. FTP sites are indexed by title and keyword, and Archie searches these indexes for the file you want. An FTP utility is provided in Windows 95.
- Telnet is a connectivity tool that allows you to start a terminal session with a telnet server. A Telnet utility is provided in Windows 95.
- Gopher is a search tool that presents information in a hierarchical menu system similar to a table of contents. Veronica is a tool that searches for text in Gopher menus.
- WAIS (Wide-Area Information Service) indexes large text files, documents, and periodicals. You can search WAIS indexes for a wide variety of information.
- Finger commands allow you to view the status of a remote site or user.
- Mail readers allow you to use electronic mail on the Internet if your Internet access provider provides you with an account.
- Search engines are sites on the Internet that allow you to enter a search command and receive a list of sites containing the specified information. Search engines generally require a Web browser, such as Mosaic.
- Helper applications are add-on tools to Internet browsers that allow you to incorporate multimedia features into files. Many Internet sites provide locations where you can find and download helper applications.

Note Windows 95 provides Telnet and FTP clients for searching and browsing the Internet as described in [Navigating the Internet](#).

Downloading information.

After you locate information, you can download it to a computer using FTP, which allows you to copy files from a host to a remote server.

Useful publications.

For more information about accessing and using the Internet, the following books are recommended:

Baczewski, P., and Bang, S.; Barnett, J. *The Internet Unleashed*. Indianapolis, IN: Sams Publishing, 1994.

Braun, E. *The Internet Directory*. New York: Fawcett Columbine, 1994.

Dougherty, D., and Koman, R. *The Mosaic Handbook for Microsoft Windows*. Sebastapol, CA: O'Reilly, 1994.

Falk, B. *The Internet Roadmap*. Alameda, CA: SYBEC Inc., 1994.

Gilster, P. *The Internet Navigator*. New York, NY: Wiley, 1994.

Hahn, H., and Stout, R. *The Internet Complete Reference*. Berkeley, CA: Osborne McGraw-Hill, 1994.

Hahn, H., and Stout, R. *The Internet Yellow Pages*. Berkeley, CA: Osborne McGraw-Hill, 1994.

Kehoe, B. *Zen and the Art of the Internet: A Beginner's Guide*. Englewood Cliffs, NJ: PTR Prentice Hall, 1994.

Lynch, D., and Rose, M. *Internet System Handbook*. Reading, MA: Addison-Wesley, 1993.

Maxwell, C., and Jan, G.C. *New Riders Official Internet Yellow Pages*. New Riders Publishing, 1994.

Notes, G. *Internet Access Providers: an International Resource Directory*. Westport, CT: Mecklermedia, 1994.

Randall, N. *The World Wide Web Unleashed*. Indianapolis, IN: Sams Publishing, 1994.

Smith, R., and Gibbs, M. *Navigating the Internet*. Carmel, IN: Sams Publishing, 1993.

Tennant, R., Ober, J., and Lipow, A. *Crossing the Internet Threshold: An Instructional Handbook*. Berkeley, CA: Library Solutions Press, 1993.

Tolhurst, W., Pike, M., and Blanton, K. *Using the Internet*. Indianapolis, IN: Que, 1994.

Connecting to the Internet

Connecting a computer running Windows 95 to the Internet consists of the following steps:

- Obtaining an Internet PPP or SLIP account from an access provider (unless you are connecting through an Internet server on your network). PPP is a newer standard and offers more automatic authentication, security, and many other advantages.
- Obtaining account information (such as the user name and password) from the access provider; this is needed to connect to their server.
- Installing and configuring a modem.
- Installing Microsoft TCP/IP by using the Network option in Control Panel.
- Installing Dial-Up Networking and defining a Dial-Up Networking connection to the Internet. If your Internet access provider does not dynamically assign you DNS and IP addresses, you can set these in Dial-Up Networking for each connection you create to the Internet.

-Or -

Installing a network adapter and defining an IP address in the network adapter's TCP/IP properties dialog boxes.

- Connecting to the Internet.
- Browsing the Internet by using FTP or Telnet provided with Windows 95, or by using Gopher, Archie, WAIS, and other Web browsers, which are available commercially or as shareware from Internet servers.

Internet Access

Connecting to the Internet

Installing and Configuring a Modem

Windows 95 supports a variety of modems for dial-in access. You do not need to configure a modem differently to connect to the Internet than you would for any other Dial-Up Networking connection. For information about installing and configuring modems, see [Modems and Communications Tools](#). For information about configuring communications ports, see [Devices](#).

Obtaining an Internet Account

Most users connect to the Internet by dialing in to an Internet access provider's server that is directly connected to the Internet. An Internet access provider is a company or institution that provides access to the Internet for a fee. According to the Internet Network Information Center (InterNIC), there are more than 160 commercial Internet access providers around the country. Access providers offer a range of services and charge for them in a variety of ways.

Tip Using an Internet access provider by way of remote access is a fairly inexpensive way to reach the Internet, but its effectiveness is limited by the speed of the connection and the modem. For a good modem and a normal phone line, this speed tends to be roughly between 14.4 and 28.8 kilobytes per second (kbps). For better performance, you can use one or more integrated service digital network (ISDN) lines to achieve 64 kbps or 128 kbps.

You can find an access provider by purchasing books or magazines that list them, some of which are included in the preceding section, or by accessing lists through an online service such as America Online® or CompuServe®. Online lists of access providers include:

- PDIAL list, access by sending electronic mail to info_deli_server@netcom.com.
- America Online or CompuServe PCWorld forums.

In deciding which access provider to use, you should consider the following:

- Does the access provider offer full Internet access?
- Does the access provider support PPP?
- Does the access provider offer technical support?
- What kind of connection speeds does the access provider support?
- What kind of search tools are provided?
- Does the access provider have an adequate number of phone lines and a large enough pipe to the Internet in order to provide good response time?
- What range of services, such as mail, does the access provider offer, and at what charge?

After you have chosen an access provider, obtain the following information from the access provider when you establish a PPP or a SLIP account. You need this information in order to configure Windows 95 to access the Internet:

- Access phone number, preferably local
- Logon name
- Logon password
- Your host and domain name, if electronic mail is part of your connection services; your host name can include a POP3 host name and a SMTP host name, which are protocols used to send and receive messages on the Internet, respectively
- The NNTP server name, if Internet newsgroups are part of your connection service
- The Domain Name System (DNS) server and IP address

All SLIP accounts require you to manually configure an IP address on your computer when you connect. Access providers who support PPP usually assign IP address automatically each time you dial in to the access provider. However, some PPP access providers might require manual configuration of an IP address as described in [Setting the Domain Name System Server and IP Addresses](#). You also need, in most cases, to configure the IP address of the access provider's DNS server.

More information is provided about these settings in the following sections and in [Network Technical Discussion](#).

Internet Access

Connecting to the Internet

Internet Access Providers Successfully Tested with Windows 95

The number of companies providing access to the Internet changes daily. In addition, the services that any one Internet access provider offers also change often. Microsoft tested almost 200 Internet access providers to see if Windows 95 could successfully connect through them to the Internet. The following list presents those access providers to which Windows 95 consistently connected during this testing process. Notice that the information contained in this table is subject to change.

SLI	PPP	Company	Phone number
P			
Yes	Yes	a2i Communications	415-293-8078
No	Yes	Actrix Networks Ltd.	644-389-6316
Yes	Yes	Adhesive Media, Inc.	512-478-9900
No	Yes	AMT Solutions Group, Inc. - Island Net	800-331-3055
Yes	Yes	APK- Public Access UNI* Site	216-481-9428
Yes	Yes	BARRNet (Bay Area Regional Research Network)	415-725-7003
No	Yes	Beckmeyer Development	510-530-9637
Yes	Yes	Berbee Information Networks Corporation	608-233-2228
Yes	No	Caprica Telecomputing Resources	213-266-0822
No	Yes	CCNET Communications	800-CCNET-4-U
Yes	No	CERFnet (California Education and Research Federation Network)	619-455-3942
No	Yes	CFTnet	813-980-1317
No	Yes	CICNet (Committee on Institutional Cooperation Network)	313-998-6700
Yes	Yes	Cloud 9 Internet	914-682-0626
Yes	No	Commercial Link Systems	49-431-979-0161
No	Yes	Communications Accessibles Montreal	514-288-2581
Yes	Yes	CompuTech	509-624-6798
No	Yes	CyberGate, Inc.	305-425-GATE
No	Yes	Cyberspace	206-505-5577
No	Yes	Demon Internet Systems (DIS)	4+44(0)-81-349-0063
Yes	No	Digex (Digital Express Group)	301-847-5000
No	Yes	DKnet	45-39-17-99-00
Yes	No	Engineering International, Inc.	505-343-1060
Yes	No	ESDATA Ltd.	372-2-527-504
Yes	Yes	EUnet Austria	43-1-317-4969
No	Yes	EUnet Belgium	32-16-201-015 x3635
No	Yes	EUnet Bulgaria	359-52-259-135
No	Yes	EUnet Finland	358-0-400-2060
No	Yes	EUnet France	33-1-53-81-60-60
Yes	Yes	FREE.ORG	715-387-1700
No	Yes	Fullfeed Communications	608-246-4329

Yes	No	Global Enterprise Service, Inc. (JvNCnet)	609-897-7309
Yes	Yes	Helix	604-689-8544
Yes	Yes	HookUp Communication Corporation	905-847-8000
No	Yes	ICE Online	604-298-4346
No	Yes	IEunet Ltd., Ireland's Internet Services Supplier	353-1-679-0832
Yes	Yes	IgLou Internet Services	502-968-8500
No	Yes	ILINK,LPD	512-388-2393
No	Yes	Individual Network e.V. (IN)	49-441-980-8556
No	Yes	Infinet, L.C.	800-849-7214
No	Yes	InterAccess	800-967-1580
Yes	Yes	International Internet Association (IIA)	201-928-1000
No	Yes	Internet Access Cincinnati	513-887-8877
No	Yes	Internet Direct, Inc.	602-274-0100
No	Yes	Internet Express	800-592-1241
No	Yes	Ireland On-Line	353-(0)-91-92727
No	Yes	ITnet S.p.A.	39-10-353-2747
Yes	Yes	JARING (MIMOS - Malaysian Institute of Microelectronics Systems)	60-3-254-9601
No	Yes	MBnet	204-474-6236
No	Yes	Metrix Interlink Corp.	514-933-9171
Yes	Yes	MIDnet	402 472-7600
No	Yes	MIND LINK! Communications Corp.	604-534-5663
No	Yes	MIX	414-351-1868
Yes	Yes	MrNet	612-342-2894
No	Yes	Msen, Inc.	313-998-4562
No	Yes	MV Communications, Inc.	603-429-2223
No	Yes	NB*net - New Brunswick's Regional Network	506-694-6404
No	Yes	Net Access	215-576-8669
No	Yes	Network Access Services	206-733-9279
No	Yes	NevadaNet	702-784-6861
No	Yes	NorthWestNet	206-562-3000
No	Yes	Northwest Nexus Inc.	206-455-3505
Yes	Yes	Northwest Technical Services Group	206-562-3000
No	Yes	Nuance Network Services	205-533-4296
No	Yes	Olympus Net	206-385-0464
No	Yes	On-Ramp Technologies, Inc.	214-746-4710
No	Yes	Paradigm Communications Inc.	203-250-7397
No	Yes	Personal InterNet Gate (PING)	43-1-319-43-36
No	Yes	PIPEX	44-223-424-616
No	Yes	Portal	408-973-9111
No	Yes	RAINet Pacific Systems Group	503-227-5665
Yes	Yes	RESTENA	352-42-44-09
No	Yes	Resudox	613-567-6925

No	Yes	Rocky Mountain Internet, Inc.	719-576-6845
No	Yes	Route 66 Networks, Inc.	206-324-6666
No	Yes	SEANET (OSD, Inc.)	206-343-7828
Yes	Yes	Sense Media	206-451-9400
No	Yes	Slip Net	415-281-3197
Yes	Yes	SunBelt	803-324-6205
Yes	Yes	SWITCH	41-1-268-1520
Yes	No	Teleport, Inc.	503-223-4245
No	Yes	Texas Metronet	214-705-2900
Yes	No	The Black Box	713-480-2684
No	Yes	The Cyberspace Station	619-634-2894
No	Yes	The Internet Access Company	617-275-2221
No	Yes	UUNET Canada, Inc.	416-368-6621
No	Yes	UUNET Technologies, Inc.	800-488-6386
No	Yes	Vnet Internet Access, Inc.	800-377-3282
No	Yes	Wimsey Information Services	604-923-4000
Yes	No	WLN	206-421-4741
Yes	Yes	World Wide Access	708-367-1870

Internet Access

Connecting to the Internet

Installing TCP/IP

Connecting the millions of computer networks on the Internet would not be possible without a standard set of protocols. Each Internet standard is described in a document called a request for comment (RFC). TCP/IP is the standard on the Internet because it combines a number of different protocols that make it possible to communicate across interconnected networks that have diverse hardware and operating systems.

To connect to the Internet, you must install TCP/IP. Windows 95 will automatically allow (bind) TCP/IP to work with a network adapter or with the Microsoft Dial-Up adapter. You can install TCP/IP when you install Windows 95, or you can install it after Setup by using the Network option in Control Panel.



To install TCP/IP

1. In the Network option in Control Panel, click the Add button.
2. In the Select Network Component Type dialog box, double-click Protocol.
3. In the Select Network Protocol dialog box, in the Manufacturers list, click Microsoft and then in the Network Protocols list, click Microsoft TCP/IP. Click OK.



To verify that TCP/IP is bound to the Microsoft Dial-Up adapter or a network adapter

- In the Network option in Control Panel, scroll through the list of network components to see if an arrow to the right of TCP/IP points to the Dial-Up adapter or another network adapter.

When you install Dial-Up Networking or another network adapter, Windows 95 automatically binds TCP/IP to the adapters if TCP/IP has been previously installed. If your computer has multiple network adapters, an entry for TCP/IP is displayed for each one. You must configure each adapter with its own TCP/IP settings.

Setting the Domain Name System Server and IP Addresses

The Internet uses the Domain Name System (DNS) to translate computer and domain names into IP addresses. A DNS server maintains a database that maps domain names to IP addresses as specified by network administrators. The DNS organizes the names of hosts in a hierarchical fashion, similar to a file system.

Before you can use TCP/IP to connect to the Internet, you need to configure a computer to recognize DNS information. Some Internet access providers dynamically assign IP addresses for DNS servers, but most do not. Most PPP Internet access providers do dynamically assign IP addresses. If an access provider does not dynamically assign either a DNS IP address or your IP address, you should set these in the TCP/IP Settings dialog box in Dial-Up Networking for each connection you create.

If, however, you have a static, direct LAN connection to the Internet or other TCP/IP network, then you should set the DNS IP address and your IP address in TCP/IP properties in the Network option in Control Panel. You do not need to set this information if your LAN's Internet access server dynamically assigns these to you; for example, if you are using a server with Dynamic Host Configure Protocol (DHCP) capabilities, such as a DHCP server on a Windows NT Server network, it will assign IP address information dynamically.

Note The following procedures assume that your computer has Microsoft TCP/IP installed as a network protocol. If your site uses another vendor's version of TCP/IP, you must configure the protocol as recommended by the protocol vendor.



To set the DNS IP address for a direct LAN connection to the Internet

1. In the Network option in Control Panel, double-click the TCP/IP entry for the network adapter in the network component list.
2. In the TCP/IP Properties dialog box, click the DNS Configuration tab.

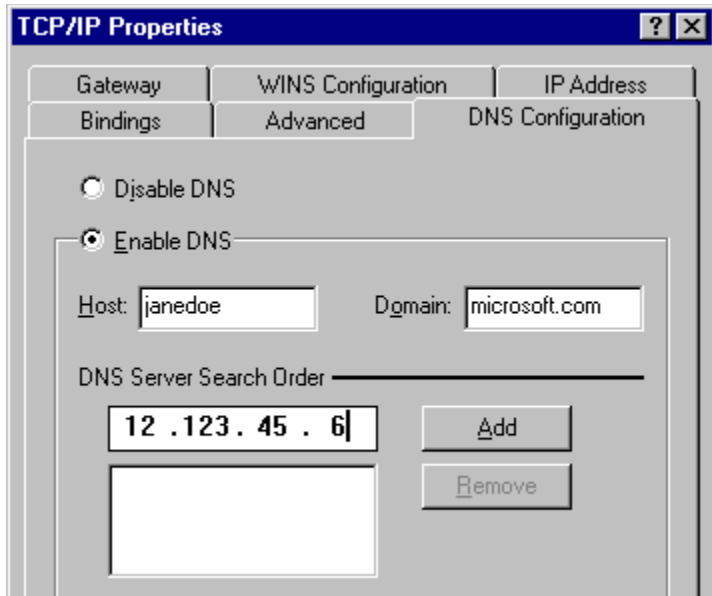

3. Click Enable DNS, and then, in the Host and Domain boxes, type your host name and domain name, respectively. These names identify you on the Internet.
4. In the DNS Server Search Order box, type the address of your LAN's DNS server in the DNS Server Search Order box.

If your network has more than one DNS server, type each DNS server and then click Add. DNS settings are currently global across all instances of TCP/IP. This allows you to rely on a secondary

DNS server if the primary DNS server is down. The first server listed is the first one searched.



To set the DNS IP address for each connection in Dial-Up Networking

1. In Dial-Up Networking, right-click the connection you defined for the Internet, and then click Properties.
2. In the connection's properties, click Server Type, and then click TCP/IP Settings.

TCP/IP Settings

Server assigned IP address

Specify an IP address

IP address: 223 . 103 . 5 . 35

Server assigned name server addresses

Specify name server addresses

Primary DNS: 12 . 123 . 45 . 6

Secondary DNS: 12 . 123 . 32 . 5

Primary WINS: 223 . 103 . 0 . 2

Secondary WINS: 223 . 103 . 0 . 4

Use IP header compression

Use default gateway on remote network

OK Cancel

3. In the TCP/IP Settings dialog box, click the option named Specify An IP Address, and type your IP address.
4. Click the option named Specify Name Server Address, and then type the IP address of the DNS server in the Primary DNS box.

Important Because IP addresses identify nodes on an interconnected network, each host on the internetwork must be assigned a unique IP address, valid for its particular network.



To define the IP address for a direct LAN connection to the Internet

1. In the Network option in Control Panel, double-click TCP/IP for the network adapter.
2. In the TCP/IP Properties dialog box, click the IP Address tab, and then click the Specify An IP Address option.

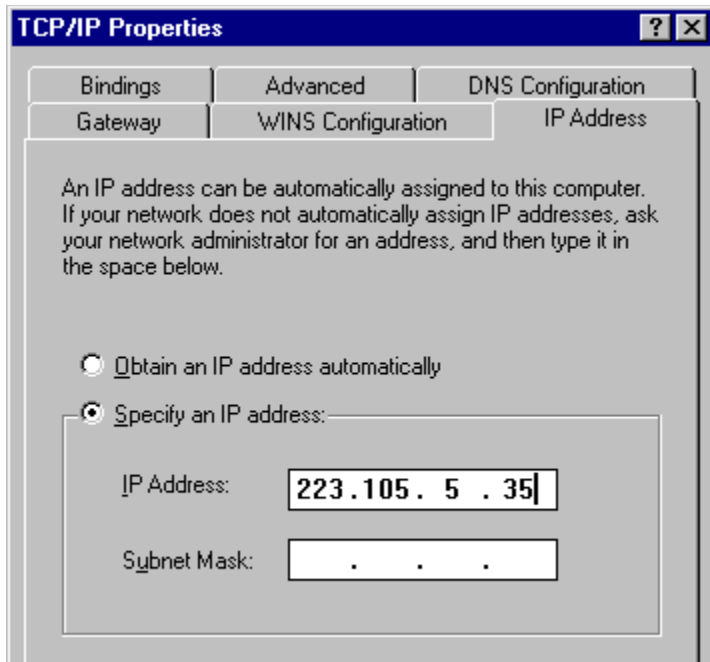

3. In the IP Address box, type your IP address. After you type the address, the subnet mask will be provided automatically. Click OK.



To define an IP address if the access provider does not dynamically assign one

- In the TCP/IP IP Address dialog box, click the option named Specify An IP Address, and then type your IP address.

Internet Access

Connecting to the Internet

Making a Dial-Up Networking Connection

After you install and configure TCP/IP, you need to configure a Dial-Up Networking connection to an Internet access provider. The way you configure the connection settings depends on the type of Internet server you are using.

To connect to a PPP server that supports the Password Authentication Protocol (PAP) or the Challenge-Handshake Authentication Protocol (CHAP), all you have to do is click the Dial-Up Networking connection you defined, and then type your user name and password in the Connect To dialog box. These types of servers include Windows NT 3.5, Shiva NetModem and LanRover, or any UNIX® server that supports PAP and CHAP.

To connect to PPP servers that does not support PAP or CHAP, or to connect to SLIP servers, you need to change settings in Dial-Up Networking for each Internet connection you define, as described in the following procedures.

For more information about defining a Dial-Up Networking connection, and about PAP and CHAP, see [Dial-Up Networking and Mobile Computing](#).

Internet Access

Connecting to the Internet

Making a Dial-Up Networking Connection

Connecting to a PPP Server

A PPP server that does not support PAP or CHAP might require that you use a terminal window to log on. In this case, you need to specify in Dial-Up Networking that a terminal window be displayed after dialing. To provide security when there is no support for PAP or CHAP, you can require that an encrypted password be used. You can also increase the connection speed by disabling network protocols other than TCP/IP.



To display a terminal window after dialing

1. In Dial-Up Networking, right-click the connection icon you created for the Internet, and then click Properties.
2. In the Properties dialog box, click the Configure button, and then click the Options tab.
3. In the Options dialog box, click the option named Bring Up Terminal Window After Dialing so it is checked, and then click OK.



To increase connection speed and require encrypted passwords

1. In Dial-Up Networking, right-click the connection icon for Internet, and then click Properties.
2. In the Properties dialog box, click the Server Types button.

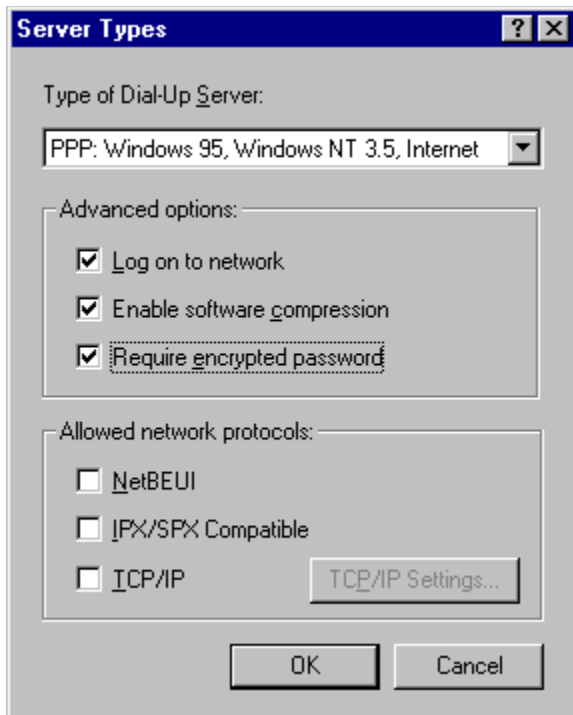

3. In the Server Types dialog box, you can increase the speed with which you connect to an Internet access provider by making sure the following options are not checked.

- Log On To Network
- NetBEUI
- IPX/SPX Compatible

4. If you need to use an encrypted password, make sure the option named Require Encrypted Password is checked.

You are now ready to connect to an Internet access provider.



To connect to a PPP server that does not support PAP or CHAP

1. In Dial-Up Networking, double-click the connection icon you created for the Internet.
2. In the Connect To dialog box, click Connect.
3. In the Terminal Window dialog box, type your user name and password and any other information that your access provider requires.
4. After you have been successfully logged on, click F7 to continue.

Note Windows 95 does not allow you to write a script to automate the terminal window logon process.

Internet Access

Connecting to the Internet

Making a Dial-Up Networking Connection

Connecting to a SLIP Server

Windows 95 Dial-Up Networking clients support SLIP and can connect to any remote access server using the SLIP standard. However, SLIP is available only on the Windows 95 compact disc.

To install SLIP

1. In the Add/Remove Programs option in Control Panel, click the Windows Setup tab, and then click the Have Disk button.
2. In the Install From Disk dialog box, type the path name to the ADMIN\APPTOOLS\SLIP directory on the compact disc, and then click OK.
3. In the Select Network Service dialog box, click UNIX Connection For Dial-Up Networking, and then click Install.

Both CSLIP and SLIP will appear in the Server Types dialog box in Dial-Up Networking

There are two types of SLIP accounts — uncompressed SLIP and compressed SLIP (CSLIP). You set what type of SLIP account you have for each connection you create in Dial-Up Networking.

To select the type of SLIP account for a connection in Dial-Up Networking

1. Right-click a connection icon, and then click Properties.
2. In the connection's properties, click Server Type.
3. In the Server Type dialog box, click the option named Slip: UNIX Connection or CSLIP Connection With IP Header Compression in the Type of Server box.

Note If you are having trouble running TCP/IP applications after connection, you might need to change the server type from CSLIP to SLIP, or vice versa.

SLIP servers do not have the capability to negotiate your TCP/IP address. Therefore, you must set Dial-Up Networking to display a terminal window after you dial the Internet server. After you type your user name and password, IP address information will be displayed in the terminal window as described in the following procedure.

To connect to a SLIP server

1. In Dial-Up Networking, right-click the connection icon you created for the Internet, and then click Properties to specify that a terminal window be displayed. Click OK.
2. In General properties, click the Server Types button.
3. In the Server Types dialog box, click the option named SLIP UNIX Connection or the option named CSLIP UNIX Connection With IP Header Compression, and then click OK.

You can also make sure the Log On To Network check box is cleared because SLIP servers allow you to log on only in a terminal window. Notice that the only protocol allowed is TCP/IP.

4. In Dial-Up Networking, double-click the icon for the connection.
5. In the Connect To dialog box, click Connect.
6. After the modem establishes a connection, the Post Dial Terminal Screen dialog box appears for you to log on to the SLIP server and receive your IP address.

You must follow the provider's guidelines for logging on to its server. Most Internet access providers require only that you type a user name and password. However, other access providers require additional information.

In most cases, after you type your user name and password, the access provider will display two IP addresses, a host IP address and your IP address. (If the access provider does not display the IP addresses, you should find them out from them.) The second address displayed is usually your IP address, which you should write down, and then click F7.

7. In the SLIP Connection IP Address dialog box, type your IP address, and then click OK.
8. If your Internet access provider assigns you the same IP address each time you connect then, after

you finish an Internet session, type your IP address in the TCP/IP Settings dialog box for that connection in Dial-Up Networking. The next time you connect to the Internet SLIP server using this connection, you will not have to type your IP address.

Note You can use the **ping** command at the command prompt to differentiate the local from the host IP address. At the command prompt, type **ping** and the local IP address (for example, **123.45.6.7**), and then try **ping** with another server on the Internet. If the local address works, and the server address does not, contact the access provider.

After you connect to an Internet access provider, Windows 95 displays a dialog box named Connected To Internet (or whatever name you gave the Dial-Up Networking connection to the Internet). You can minimize this dialog box and begin your Internet session by running FTP, Telnet, or other Internet browsing applications.

Using WINIPCFG to Verify Internet Connections

The IP Configuration utility (WINIPCFG) is a troubleshooting utility that displays all current TCP/IP network configuration values for any computer running Microsoft TCP/IP. Network configuration values include the current IP address allocated to the computer and other useful data about the TCP/IP allocation. This utility is of particular use on networks using DHCP, allowing users to determine which TCP/IP configuration values have been configured by DHCP.

The IP Configuration utility does not, however, dynamically update information. If you make any changes, such as disconnecting, you must exit the IP Configuration utility and restart it again.

To run WINIPCFG, click the Start button, click Run, and type **winipcfg**.

Internet Access

Connecting to the Internet

Technical Notes for IP address on TCP/IP Networks

This section provides details about IP addresses and subnet masks.

Every host interface, or node, on a TCP/IP network is identified by a unique IP address. This address is used to identify a host on a network; it also specifies routing information in an internetwork. The *IP address* identifies a computer as a 32-bit address that is unique across a TCP/IP network. An address is usually represented in dotted decimal notation, which depicts each octet (eight bits, or one byte) of an IP address as its decimal value and separates each octet with a period. An IP address looks like this:

102.54.94.97

Network ID and Host ID

Although an IP address is a single value, it contains two pieces of information: the network ID and the host (or system) ID for your computer.

- The *network ID* identifies a group of computers and other devices that are all located on the same logical network, which are separated or interconnected by routers. In internetworks (networks formed by a collection of local area networks), there is a unique network ID for each network.
- The *host ID* identifies your computer within a particular network ID. (A host is any device that is attached to the network and uses TCP/IP.)

Networks that connect to the public Internet must obtain an official network ID from the InterNIC to guarantee unique IP network IDs. After receiving a network ID, the local network administrator must assign unique host IDs for computers within the local network. Although private networks not connected to the Internet can choose to use their own network identifiers, obtaining a valid network ID from InterNIC allows a private network to connect to the Internet in the future without reassigning addresses.

The Internet community has defined address *classes* to accommodate networks of varying sizes. Each network class can be discerned from the first octet of its IP address. The following table summarizes the relationship between the first octet of a given address and its network ID and host ID fields. It also identifies the total number of network IDs and host IDs for each address class that participates in the Internet addressing scheme. This sample uses w.x.y.z to designate the bytes of the IP address.

IP Address Classes

Class	w values ^{1,2}	Network ID	Host ID	Available networks	Available hosts per net
A	1–126	w	x.y.z	126	16,777,214
B	128–191	w.x	y.z	16,384	65,534
C	192–223	w.x.y	z	2,097,151	254

¹ Inclusive range for the first octet in the IP address.

² The address 127 is reserved for loopback testing and interprocess communication on the local computer; it is not a valid network address. Addresses 224 and above are reserved for special protocols (IGMP multicast and others), and cannot be used as host addresses.

A network host uses the network ID and host ID to determine which packets it should receive or ignore, and to determine the scope of its transmissions (only nodes with the same network ID accept each other's IP-level broadcasts).

Because the sender's IP address is included in every outgoing IP packet, it is useful for the receiving computer to derive the originating network ID and host ID from the IP address field. This is done by using subnet masks, as described in the following section.

Subnet Masks

Subnet masks are 32-bit values that allow the recipient of IP packets to distinguish the network ID portion of the IP address from the host ID. Similar to an IP address, the value of a subnet mask is frequently represented in dotted decimal notation. Subnet masks are determined by assigning 1s to bits that belong to the network ID and 0s to bits that belong to the host ID. When the bits are in place, the 32-bit value is converted to dotted decimal notation, as shown in the following table.

Default Subnet Masks for Standard IP Address Classes

Address class	Bits for subnet mask	Subnet mask
Class-A	11111111 00000000 00000000 00000000	255.0.0.0
Class-B	11111111 11111111 00000000 00000000	255.255.0.0
Class-C	11111111 11111111 11111111 00000000	255.255.255.0

The result allows TCP/IP to determine the host and network IDs of the local computer. For example, when the IP address is 102.54.94.97 and the subnet mask is 255.255.0.0, the network ID is 102.54 and the host ID is 94.97.

Although configuring a host with a subnet mask might seem redundant after examining the previous tables (since the class of a host is easily determined), subnet masks are also used to further segment an assigned network ID among several local networks.

For example, suppose a network is assigned the Class-B network address 144.100. This is one of over 16,000 Class-B addresses capable of serving more than 65,000 nodes. However, the worldwide corporate network to which this ID is assigned is composed of 12 international LANs with 75 to 100 nodes each. Instead of applying for 11 more network IDs, it is better to use subnetting to make more effective use of the assigned ID 144.100. The third octet of the IP address can be used as a subnet ID, to define the subnet mask 255.255.255.0. This splits the Class-B address into 254 subnets: 144.100.1 through 144.100.254, each of which can have 254 nodes. (host IDs 0 and 255 should not be assigned to a computer; they are used as broadcast addresses, which are typically recognized by all computers.) Any 12 of these network addresses could be assigned to the international LANs in this example. Within each LAN, each computer is assigned a unique host ID, and they all have the subnet mask 255.255.255.0.

The preceding example demonstrates a simple (and common) subnet scheme for Class-B addresses. Sometimes it is necessary to segment only portions of an octet, using only a few bits to specify subnet IDs (such as when subnets exceed 256 nodes). Each user should check with the local network administrator to determine the network's subnet policy and the correct subnet mask. For all systems on the local network, the subnet mask must be the same for that network ID.

Internet Access

Navigating the Internet

This section provides some tips to help you find and access information on the Internet after you have connected.

Using Microsoft TCP/IP Utilities

Windows 95 provides several TCP/IP utilities for copying files, initiating host sessions with other servers, and checking the status of your IP configuration. For more information about these tools, see [Command-Line Commands Summary](#). For more information about steps for using TCP/IP utilities such as **ping** to verify your connection, see the troubleshooting section of [Network Technical Discussion](#).

FTP is a file-transfer protocol that allows the transfer of text and binary files between a host computer and a computer. FTP requires you to log on to the remote host for user authentication, but logging on as “anonymous” can be used to acquire free software and documents through the Internet. Some FTP servers have a limit to the number of anonymous users they can handle at any one time, so you might have to attempt to connect more than once to get a connection.

You can use FTP to access the Microsoft FTP server to get troubleshooting help and other information. This support service uses anonymous FTP to provide documentation, utilities, updated drivers, and other information for many Microsoft systems products.



To get support from Microsoft by using the Internet

1. Make sure you are connected to your Internet provider.
2. To start FTP, click the Start menu, click Run, type **ftp**, and then click OK.
3. At the command prompt, type **open ftp.microsoft.com**
4. When you are prompted to specify a user name, type **anonymous**
5. Type your Internet account name (your electronic mail name) as your password, using the format *userid@hostname.domain*.

As you type your Internet account name, characters might not appear on the screen. This is a security measure to protect your password.

You are now connected to the root directory of the Microsoft FTP site.

For information about navigating and downloading files, see the following section.

Using FTP to Browse and Download Files

This section describes how to see a listing of directories and files at an FTP site, and how to change directories and download files. Most FTP servers contain text files that describe the layout of their entire directory structure to help you find what you need. For example, the text file on DIRMAP.TXT describes that server's directory structure.



To list the directories and folders at an FTP site

- At the ftp> prompt, type **ls**



To view more details about the current directory

- At the ftp> prompt, type **ls -l**

This command provides a detailed listing similar to the following:

```
dr-  1  owne  grou  0      Aug   16:2  advsys
xr-
xr-
x
dr-  1  owne  grou  0      Aug   5:37  deskapps
xr-
xr-
x
dr-  1  owne  grou  0      Aug  10:5  developer
xr-
xr-
x
-r-  1  owne  grou  4161  Sep   7:43  dirmap.txt
xr-
xr-
x
-r-  1  owne  grou  712   Aug  15:0  disclaimer.t
xr-
xr-
x
-r-  1  owne  grou  860   Sep   8:40  index.txt
xr-
xr-
x
```

In this listing:

- The left column indicates whether the item is a file (r) or a directory (dr).
- The fifth column indicates the byte size of each file.
- The last column describes the name of the file, directory, or link.

A link to a file or directory somewhere else on the FTP site (similar to a shortcut to a folder or file in Windows 95).



To change directories

- At the ftp> prompt, type **cd *directory_name***

For example, to get more information about desktop applications, type **cd deskapps**



To go back to the previous directory

- At the ftp> prompt, type **cd**

If you have navigated through many directories and want to go back to the beginning, instead of

typing `cd ..` again and again, you can type `cd /` to return to the root directory of this host.

Tip Notice that the forward slash “/” is used (as opposed to the backslash “\” that MS-DOS and Windows users are accustomed to) On most UNIX computers, the way to change directories is with the forward slash. Currently, most FTP servers you access only understand that particular command, so the forward slash will always work. However, if you dial into a computer running Windows NT, such as <ftp.microsoft.com>, it understands both the forward slash and the backslash.

Downloading Files with FTP

To download files from the Internet, you must indicate whether the file is an ASCII or a binary file. By default, when you begin using FTP, you are working in ASCII mode. To transfer text files, it is not necessary to change modes; however, you cannot transfer a binary file while you are in ASCII mode.

Tip Most text-based FTP clients are case-sensitive, so make sure you use the correct case when you attempt to transfer resources from these FTP sites.



To switch from ASCII to binary transfer mode

- At the ftp> prompt, type **binary**

The following message appears to confirm the change to binary transfer mode:

```
200 Type set to I
```



To switch from binary transfer mode to ASCII

- At the ftp> prompt, type **ascii**

The following message appears to confirm the change to ASCII:

```
200 Type set to A
```



To transfer a file to your computer

- At the ftp> prompt, type **get filename**

For example, to get the directory map on the Microsoft FTP server, type **get dirmap.txt**

To place the file on a computer with a name other than the one it had on the server, type **get filename newname**

If you get an error, remember that you are using software that is case-sensitive, so make sure you typed the word **dirmap.txt** exactly.

When you see the ftp> prompt again, look in Windows Explorer for the DIRMAP.TXT file and open it by using a text processor such as WordPad.



To disconnect from your host

- At the ftp> prompt, type **disconnect**



To stop using FTP

- At the ftp> prompt, type **quit**

Using Windows 95 Telnet

Much of the information on the Internet is still available only if you use Telnet. Windows 95 provides a version of Telnet that you can run from the Start menu.



To run Telnet from the Start menu

1. Click the Start menu, click Run and, then type **telnet**
 2. In Telnet, click the Connect menu, and then click Remote Session.
 3. In the Connect dialog box, type the host name of the Telnet site to which you want to connect to.
 4. In the Term Type box select a terminal mode. The default is VT-100.
 5. In the Port box, select a port. The default is Telnet.
 6. To start the Telnet session, click the Connect button.
 7. To capture data to a file, type **terminal/start logging**
- For more information about using Telnet, see online Help.

Internet Access

Navigating the Internet

Browsing the Internet with Public Domain Tools

In addition to FTP and Telnet, there are a variety of applications available on the Internet to navigate it, including Mosaic, Gopher, Archie, and WAIS. These applications allow you to easily access the Internet, and they offer greater searching and browsing capabilities than FTP and Telnet. The following sections provide information about several of these applications. You should contact your Internet access provider to find out locations for these programs.

Note There are many TCP/IP applications from other vendors that offer Internet browsing, viewing, and connection capabilities. Many of these applications are 16-bit and do not currently work with the 32-bit version of TCP/IP provided with Windows 95.

To download these public domain and shareware applications, you need to use FTP as described in [Command-Line Commands Summary](#).

Caution Windows 95 provides a 32-bit Windows Sockets interface (WINSOCK.DLL). Any attempt to override the Windows 95 interface could cause TCP/IP applications to not work correctly or could cause the computer to stop responding.

Internet Access

Navigating the Internet

Browsing the Internet with Public Domain Tools

Using Mosaic

NCSA Mosaic is a graphical network navigational tool that provides users with access to networked information on the Internet and the World Wide Web (WWW) distributed information system. NCSA Mosaic enables the user to retrieve and display a wide variety of data types, including text, image, video, and audio. It uses a hypertext user interface similar to Windows Help files, so you can click on a word or image of interest, and Mosaic connects you to the appropriate resource. There are now numerous versions of Mosaic available.



To access Mosaic

1. Connect to ftp.ncsa.uiuc.edu.
2. At the ftp> prompt, type **cd /web**
3. Read the FAQ.TXT file in this directory and follow the instructions for installing Mosaic.
4. To connect to the Microsoft Word Wide Web server, click in the Document URL box, and then type **http://www.microsoft.com**
5. Click the highlighted words to navigate around the Web site.

Internet Access

Navigating the Internet

Browsing the Internet with Public Domain Tools

Using Gopher

Gopher is a tool that offers menu-based access to Internet information. Gopher hides the intricacies of FTP from the user and bypasses complicated TCP/IP addresses and connections. Users can choose information from a list of menus, and Gopher makes the connections that are necessary to retrieve the files. Gopher is most helpful when you need to find specific pieces of information on the Internet.

Internet Access

Navigating the Internet

Browsing the Internet with Public Domain Tools

Using Archie

Archie is a server that supports a database of anonymous FTP sites and their contents. It was created by the Archive Group at McGill University in Montreal, Canada, where Archie is maintained. Archie stores the contents, descriptions, and filenames about a great number of FTP sites. Archie applications are available from many major Internet sites.

Internet Access

Navigating the Internet

Browsing the Internet with Public Domain Tools

Using Wide-Area Information Server (WAIS)

With WAIS, you can browse the hundreds of databases and library catalogs on the Internet in an organized way. WAIS searches the contents of documents based on words as opposed to titles, which is what as other search tools use. After a search, WAIS displays a list of documents. This list, however, can be extremely large, so WAIS sorts the documents based on how many times a key word was found in each one. If the list is too large, you can narrow the search by specifying categories.

Tips for Adding a Gateway Server

A dedicated connection to the Internet provides many advantages over connecting by using a modem with a telephone line to an Internet access provider. Having a gateway server can improve performance and reduce costs. You'll need to set up hardware and obtain a domain name so others can send information to your gateway.

If you set up a dedicated computer to act as a router or gateway server to the Internet, it should use a high-speed connection, such as T1 or 56KB lines, instead of a slower telephone line. The T1 line connects to the computer using a special network adapter.

Networks that connect to the Internet must obtain an official network ID from the InterNIC to guarantee unique IP network IDs. Contact the InterNIC by sending electronic mail to info@internic.net (in the U. S., call (800) 444-4345, or for Canada and overseas, call (619) 455-4600).

Internet registration requests can be sent to hostmaster@internic.net. You can also use FTP to connect to [is.internic.net](ftp://is.internic.net), then log on as anonymous and change to the /INFOSOURCE/FAQ directory. After receiving a network ID, the local network administrator must assign unique host IDs for computers within the local network.

Internet Access

Troubleshooting Internet Connections

Your modem does not dial.

Use the troubleshooting aid for modems in online Help. See also the modem troubleshooting section in [Modems and Communications Tools](#).

You cannot connect to the Internet access provider.

- Check the Server Types dialog box in Dial-Up Networking to make sure your server type is correct.
 - If you have a PPP account, make sure the server type is not SLIP or CSLIP.
 - If you have a SLIP account, make sure you have the correct type selected, either CSLIP or SLIP. Also, make sure you typed the correct IP address in the SLIP Connection IP Address dialog box.
- Check the Network option in Control Panel to make sure TCP/IP is bound to the Dial-Up or network adapter.

You connect to the Internet access provider but cannot obtain information from other Internet sites.

Try using the **ping** command to connect to other Internet sites.



To test a connection is working by using the ping command

1. At the command prompt, type
ping 198.105.232.1 (for the Microsoft FTP server)
-Or -
ping 198.105.232.6 (for the Microsoft WWW server)

If this works, then TCP/IP is working over your connection.

2. At the command prompt, type **ftp.microsoft.com**

-Or-

Run FTP or Telnet.

If this works, then your DNS settings are correct and working.

If there is no response, check to make sure the DNS IP addresses are correct by running the IP Configuration utility (WINIPCFG).

You cannot view or download hypertext documents.

To view or download hypertext documents, such as World Wide Web home pages, you must use an Internet browser. The Telnet and FTP utilities that are provided with Windows 95 only support basic navigation on the Internet.

Windows 95 Reference

This part of the *Windows 95 Resource Kit* contains the following chapters, which provide reference information for using Windows 95.

Chapter 31 Windows 95 Architecture

Provides a brief review of the Windows 95 architecture to assist you in understanding how the various key operating system components operate.

Chapter 32 Windows 95 Network Architecture

Presents specific information about the architecture for the networking components in Windows 95.

Chapter 33 Windows 95 Registry

Describes the Windows 95 Registry and presents background information about the structure and contents of the Registry.

Chapter 34 International Windows 95

Summarizes information about local editions for Windows 95, and provides technical details about defining regional settings in setup scripts and using the multilingual support in Windows 95.

Chapter 35 General Troubleshooting

Provides background information for troubleshooting Windows 95.

Introduction

This chapter provides a brief review of the Windows 95 architecture to assist you in understanding how the key operating system components function and interrelate.

- Windows 95 Architecture Components
- Windows 95 Registry
- Device Drivers
- Configuration Manager
- Virtual Machine Manager
 - Process Scheduling and Multitasking
 - Memory Paging
 - Support for MS-DOS Mode
- Installable File Systems
 - Installable File System Manager
 - File System Drivers
 - Block I/O Subsystem
- Core System Components
 - User
 - Kernel
 - Graphical Device Interface
- User Interface
- Application Support

Windows 95 Architecture Components

Windows 95 features a new device driver model, a new file system, a new 32-bit graphics engine, and new 32-bit print, communications, and multimedia subsystems. Windows 95 is a 32-bit operating system with built-in connectivity support. It provides high performance, robustness, and complete backward compatibility.

All of these features are supported by the modular design shown in the following diagram.

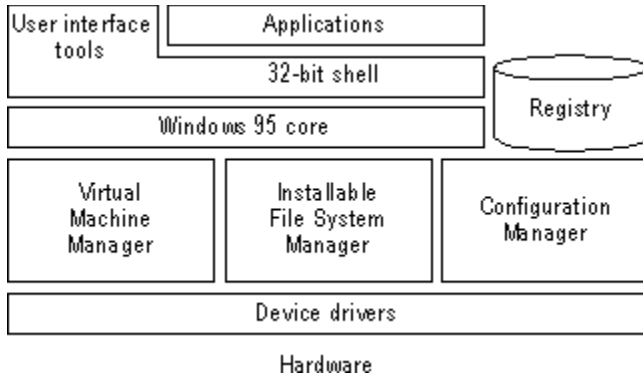

Although its architectural design is based on Windows version 3.1, Windows 95 includes several improvements over the earlier operating system:

- A fully integrated 32-bit, protected-mode operating system, which eliminates the need for a separate copy of MS-DOS.
- Preemptive multitasking and multithreading support, which improves system responsiveness and offers smooth background processing.
- 32-bit installable file systems including VFAT, CDFS, and network redirectors. These support better performance, use of long filenames, and an open architecture to support future growth.
- 32-bit device drivers, available throughout the system, which deliver improved performance and intelligent memory use.
- A complete 32-bit kernel, including memory management and process scheduling and management.
- Improved system-wide robustness and cleanup after an application ends or fails. This delivers a more stable and reliable operating environment.
- More dynamic environment configuration, which reduces the need for users to adjust their systems.
- Improved system capacity, which allows multiple applications and system tasks to run well concurrently.

This chapter describes the key components that make up the Windows 95 architecture beginning with its central information store, the Registry, and proceeding from bottom to top.

Windows 95 Registry

The central information database for Windows 95 is called the Registry. This hierarchical database both simplifies the operating system and makes it more adaptable. The Registry simplifies the operating system by eliminating the need for AUTOEXEC.BAT, CONFIG.SYS, and INI files (except when legacy applications require them). It makes the operating system more adaptable by storing user-specific and configuration-specific information so you can share one computer among multiple users and you can have more than one configuration (such as in-the-office and on-the-road configurations) for each computer.

A primary role of the Registry in Windows 95 is to serve as a central repository for hardware-specific information for use by the hardware detection and Plug and Play system components. Windows 95 maintains information about hardware components and devices that have been identified through an enumeration process in the hierarchical structure of the Registry, as described in [Configuration Manager](#). When new devices are installed, the system checks the existing configuration in the Registry to determine the hardware resources (for example, IRQs, I/O addresses, DMA channels, and so on) that are not being used, so the new device can be properly configured without conflicting with a device already installed in the system.

Windows 3.1 used initialization (INI) files to store system-specific or application-specific information on the state or configuration of the system. For example, the WIN.INI file stored information about the appearance of the Windows environment, the SYSTEM.INI file stored system-specific information on the hardware and device driver configuration of the system, and various INI files (such as MSMAIL.INI and WINWORD6.INI) stored application-specific information.

The Registry remedies this situation by providing a single location for a computer's configuration information. The following table shows other difficulties or limitations caused by using INI files that are overcome by using the Registry.

Problems using INI files

INI files are text-based, and are limited to 64K in total size.

Information stored in INI files is non-hierarchical and supports only two levels of information (specifically, section headings with a list of key names under each).

Many INI files contain a myriad of switches and entries that are complicated to configure or are used only by operating system components.

INI files provide no mechanism for storing user-specific information, thus making it difficult for multiple users to share a single computer or for users who move around on the network to have access to their user-specific settings.

Configuration information in INI files is local to each system, and no API mechanisms are available for remotely managing configuration, thus making it difficult to manage

Solutions using the Registry

The Registry has no size restriction and can include binary and text values.

The Registry is hierarchically arranged.

The Registry contains more standardized values.

The Hkey_Users key stores user-specific information.

The Registry can be remotely administered and system policies (which are stored as Registry values) can be downloaded from a central server each time a new user logs on. For more information, see [User](#)

multiple computers.

Profiles and System Policies, and
Remote Administration.

When you upgrade from Windows 3.1 to Windows 95, system-specific information such as the static reference to loading virtual device drivers is moved, as appropriate, from the SYSTEM.INI file to the Registry.

For backward compatibility, Windows 95 does not ignore AUTOEXEC.BAT, CONFIG.SYS, and INI files, because many Win16-based applications still use them. For example, Windows 95 allows Win16-based applications to use INI files for the parameters, device drivers, and so on, that the applications need to run. In addition, Windows 95 continues to examine the [386Enh] section of SYSTEM.INI at startup to check for virtual device drivers.

One advantage of the Registry for Win32-based applications is that many of the Win32-based Registry APIs can be used remotely through the remote procedure call (RPC) mechanism in Windows 95 to provide access to Registry information across a network. This means that network administrators can use system management tools to access the contents of the Registry for any computer on the network. (Of course, the remote computer must be configured to allow remote administration, and must have user-level security.)

With Windows 95 remote administration, industry management mechanisms such as Simple Network Management Protocol (SNMP) can easily be integrated into Windows 95, simplifying the management and support burden of the network administrator. For more information, see Remote Administration.

Device Drivers

Windows 95 provides improved support for hardware devices and peripherals including disk devices, display adapters, mice and other pointing devices, modems, fax machines, and printers.

In Windows 3.1, device drivers were, for the most part, monolithic and complex to develop. Windows 95 uses a universal driver/mini-driver architecture that makes it easier for hardware vendors to provide device-specific code for their hardware.

A *universal driver* includes most of the code necessary for devices in a particular class of devices (such as printers or modems) to communicate with the appropriate operating system components (such as the printing or communications subsystems). A mini-driver is the relatively small and simple driver that contains any additional instructions needed by a specific device. In many cases, however, the universal driver for a particular category of devices also includes the code needed to operate devices designed to the most common standard for that category. (For example, the Unimodem driver works with all modems supporting AT commands.)

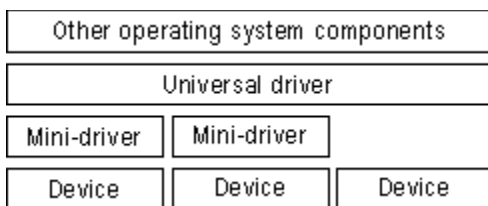

A *virtual device driver* (VxD) is a 32-bit, protected-mode driver that manages a system resource, such as a hardware device or installed software, so that more than one application can use the resource at the same time. VxD refers to a general virtual device driver—the x represents the type of device driver. For example, a virtual device driver for a display device is known as a VDD, a virtual device driver for a timer device is a VTD, a virtual device driver for a printer device is a VPD, and so forth.

With Windows 3.1, VxDs were statically loaded and took up a lot of memory space. However, Windows 95 dynamically loads VxDs — only those that are needed at any given time are loaded into memory. In addition, the new VxDs don't require all of their memory to be page-locked, thereby further increasing the available memory in the system.

VxDs support all hardware devices for a typical computer, including disk controllers, serial and parallel ports, keyboard and display devices, and so on. If the state of the hardware device can be disrupted by switching between multiple applications, the device must have a corresponding virtual device and VxD. The virtual device keeps track of the state of the device for each application and ensures that the device is in the correct state whenever an application continues.

Although most virtual devices manage hardware, some manage only installed software, such as an MS-DOS device driver or a TSR program. Such virtual devices contain code to emulate the software or ensure that the software uses data that applies only to the currently running application. Also, VxDs are often used to improve software performance.

Windows 95 virtual device driver files have a filename extension of .VXD; Windows 3.1 drivers used the .386 filename extension.

Configuration Manager

To support Plug and Play functionality, Windows 95 architecture includes a new component called Configuration Manager, which orchestrates the configuration process. This process might involve many bus and device architectures coexisting on a single system, with more than one device type using the same bus architecture, yet with each device having a separate set of configuration requirements. (A *bus* is the mechanism that allows information to be transferred between the computer and the device.) For example, a mouse and a keyboard can both use the same keyboard controller bus; a CD-ROM drive and a hard disk drive might both use the same SCSI bus.

As shown in the following illustration, Configuration Manager works with a number of subcomponents to identify each bus and each device on the system, and to identify the configuration settings for each device. Configuration Manager ensures that each device on the computer can use an IRQ, I/O port addresses, and other resources without conflict with other devices.

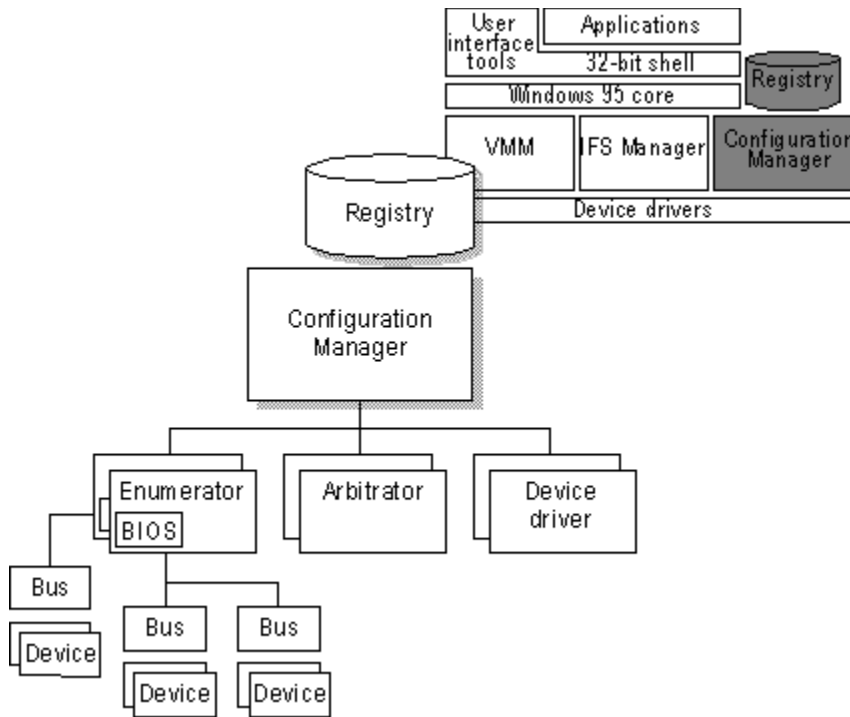

Configuration Manager also helps monitor the computer for changes in the number and type of devices present and manages the reconfiguration of the devices, as needed, when changes take place. As these events occur, Configuration Manager communicates the information to applications.

To perform its role, Configuration Manager (implemented as part of the Virtual Memory Manager, VMM32) calls on the bus enumerators to identify all the devices on their specific buses and their respective resource requirements.

Bus enumerators are new drivers that are responsible for creating the Windows 95 hardware tree. A *hardware tree* is the hierarchical representation of all the buses and devices on a computer. Each bus and each device is represented as a *node*. The following is a graphical representation of a hardware tree.

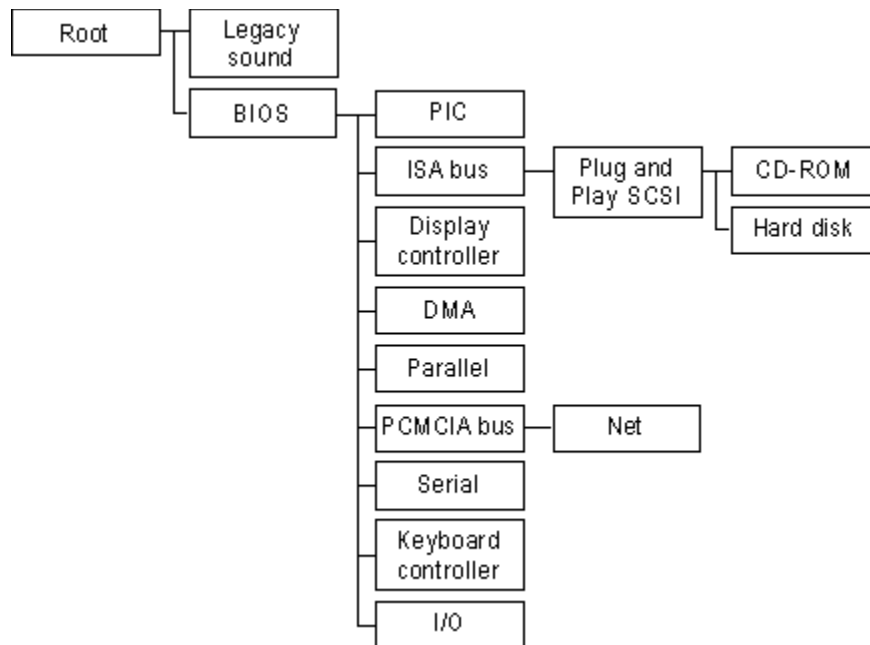

During the device enumeration process, the bus enumerator locates and gathers information from either the device drivers or the BIOS services for that particular device type. For example, the SCSI bus enumerator calls the SCSI drivers to gather information. (Some bus enumerators may instead check the hardware directly.)

For each device, a driver is loaded. When loaded, the driver waits for Configuration Manager to assign specific resources (such as IRQs) to the device. Configuration Manager calls on *resource arbitrators* to allocate resources for each device.

Resource arbitrators resolve conflicts among devices that request identical resource assignments. Windows 95 provides arbitrators for the standard I/O, memory, hardware interrupt, and DMA channel resources. (The arbitrators are separate components, rather than a part of Configuration Manager, to ensure extensibility to new types of resources, such as power allocation or automatic SCSI IDs.)

To complete the configuration process, Configuration Manager informs the device drivers about the device configuration. This process is repeated when the BIOS or one of the other bus enumerators informs Configuration Manager about an event that requires a change to the system configuration, such as the removal or insertion of a Plug and Play-compliant PCMCIA card. For more information about Plug and Play, see [Introduction to System Configuration](#).

Virtual Machine Manager

Just as Configuration Manager provides for all resources needed by each device on the computer, another component, Virtual Machine Manager, provides for resources needed for each application and system process running on the computer. Virtual Machine Manager creates and maintains the virtual machine environments in which applications and system processes run.

A *virtual machine* (VM) is an environment in memory that, from the application's perspective, looks as if it is a separate computer, complete with all of the resources available on the physical computer that an application needs to run. The Virtual Machine Manager provides each application with the system resources it needs. Virtual Machine Manager replaces WIN386.EXE in Windows 3.1.

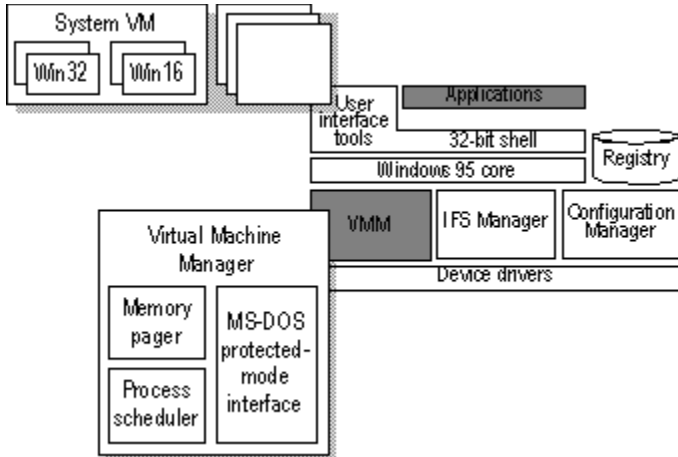

Windows 95 has a single VM called the System VM, in which all system processes run. In addition, all Win32-based and Win16-based applications run in this VM. Each MS-DOS-based application runs in its own VM. (For information on VMs, see [Core System Components](#).)

The Virtual Machine Manager is responsible for three key areas of services:

- Process scheduling
- Memory paging
- MS-DOS Mode support for MS-DOS-based applications that must have exclusive access to system resources

The following sections discuss these three areas of service.

Process Scheduling and Multitasking

The Process Scheduler is the component responsible for providing system resources to the applications and other processes you run, and for scheduling processes to allow multiple applications to run concurrently.

The Process Scheduler also schedules processes in a way that allows multiple applications and other processes to run concurrently. Windows 95 uses two methods for concurrent process scheduling — cooperative multitasking and preemptive multitasking.

With Windows 3.1, applications ran concurrently through a method known as *cooperative multitasking*. Using this method, the operating system required an application to check the message queue periodically and to relinquish control of the system to other running applications. Applications that did not check the message queue frequently would effectively “hog” CPU time and prevent the user from switching to another application. For compatibility reasons, Windows 95 cooperatively multitasks Win16-based applications.

Windows 95 uses *preemptive multitasking* for Win32-based applications. This means that the operating system takes control away from or gives control to another running task, depending on the needs of the system.

Unlike Win16-based applications, Win32-based applications do not need to yield to other running tasks to multitask properly. Win32-based applications can take advantage of *multithreading*, a mechanism that Windows 95 provides to facilitate the ability to run applications concurrently. A Win32-based application running in the system is called a *process* in terms of the operating system. Each process consists of at least a single thread of execution that identifies the code path flow as it is run by the operating system. A *thread* is a unit of code that can get a time slice from the operating system to run concurrently with other units of code, and must be associated with a process. However, a Win32-based application can initiate multiple threads for a given process to enhance the application for the user by improving throughput, enhancing responsiveness, and aiding background processing. Because of the preemptive multitasking nature of Windows 95, threads of execution allow code to be smoothly processed in the background.

A good illustration of this is the Windows 95 shell itself. Although the shell is a Win32-based process, each folder window that opens is a separate thread of execution. As a result, when you initiate a copy operation between two shell folder windows, the operation is performed on the thread of the target window. You can still use the other windows in the shell without interruption, or you can start a different copy in another window.

In another example, a word processing application (a process) can implement multiple threads to enhance operation and simplify interaction with the user. The application can have a separate thread that responds to keys typed on the keyboard by the user to place characters in a document, while another thread performs back-ground operations such as spelling checking or paginating, and while a third thread spools a document to the printer in the background.

Note Some Win16-based applications may have provided functionality similar to this; however, because Windows 3.1 didn't provide a mechanism for supporting multithreaded applications, it was up to application vendors to implement their own threading schemes. The use of threads in Windows 95 makes it easy for application vendors to add asynchronous processing of information to their applications.

Memory Paging

Windows 95, similar to Windows NT, uses a demand-paged virtual memory system. This system is based on a flat, linear address space accessed using 32-bit addresses.

Each process is allocated a unique virtual address space of 2 GB. The upper 2 GB is shared, while the lower 2 GB is private to the application. This virtual address space is divided into equal blocks, or *pages*.

Demand paging refers to a method by which code and data are moved in pages from physical memory to a temporary paging file on disk. As the information is needed by a process, it is paged back into physical memory.

The Memory PAGER maps virtual addresses from the process's address space to physical pages in the computer's memory. In doing so, it hides the physical organization of memory from the process's threads. This ensures that the thread can access its process's memory as needed, but not the memory of other processes. Therefore, as shown in the following illustration, a thread's view of its process's virtual memory (as depicted on the left) is much simpler than the real arrangement of pages in physical memory.

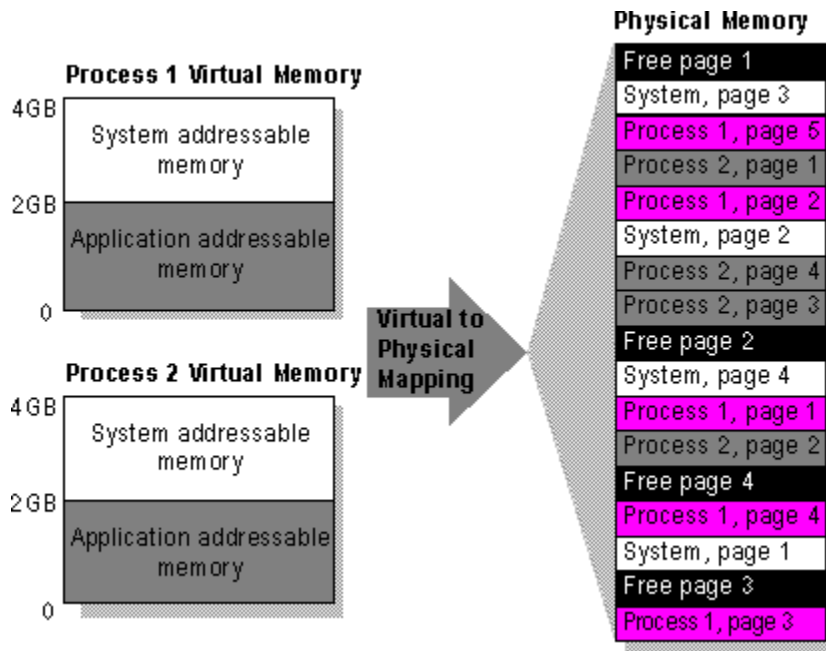

To support a 16-bit operating environment including Windows 3.1 and MS-DOS, the Intel® processor architecture uses a mechanism called a *segment*. Segments reference memory by using a 16-bit segment address, and a 16-bit offset address within the segment. A segment is 64K in size, and both applications and the operating system suffer a performance penalty for accessing information across segments.

Windows 95 addresses this issue by using the 32-bit capabilities of the 80386 (and above) processor architecture to support a flat, linear memory model for 32-bit operating system functionality and Win32-based applications. A *linear addressing model* simplifies the development process for application vendors, and removes the performance penalties imposed by the segmented memory architecture.

With this addressing model, Windows 95 allows full use of the 4 GB of addressable memory space for all 32-bit operating system components and applications. Each 32-bit application can access up to 2 GB of addressable memory space, which is large enough to support even the largest desktop application.

Windows 95 Architecture

Virtual Machine Manager

Support for MS-DOS Mode

While most MS-DOS-based applications run well in Windows 95 and can run concurrently with other Win32-based and Win16-based applications, a small number of MS-DOS-based applications require exclusive access to system resources to run. In this case, it is the Virtual Memory Manager that creates this exclusive operating environment for the application called *MS-DOS Mode*. When an MS-DOS-based application runs in MS-DOS Mode, no other applications or processes are allowed to compete for system resources — all resources are at the exclusive access of the MS-DOS-based application. For related information, see [Application Support](#).

Installable File Systems

Windows 95 features a layered file system architecture that supports multiple file systems, including VFAT and CDFS.

The new file system architecture makes the computer easier to use and improves file and disk I/O performance. Features of the new file system architecture include long filename support and a dynamic system cache for file and network I/O.

Long filename support improves ease of use because users no longer need to reference files by the MS-DOS 8.3 filename structure. Instead, users can specify up to 255 characters to identify their documents. In addition, filenames seem less cryptic and thus easier to read because Windows 95 hides the filename extensions from users.

Windows 95 I/O performance is dramatically improved over Windows 3.1. This is because Windows 95 features 32-bit protected-mode code for reading information from and writing information to the file system, and for reading information from and writing information to the disk device. It also includes 32-bit dynamically sizable caching mechanisms, and a full, 32-bit code path is available from the file system to the disk device.

Windows 95 includes an open file system architecture for future system support. It also provides disk device driver compatibility with Windows NT.

The following figure shows the file system architecture used by Windows 95.

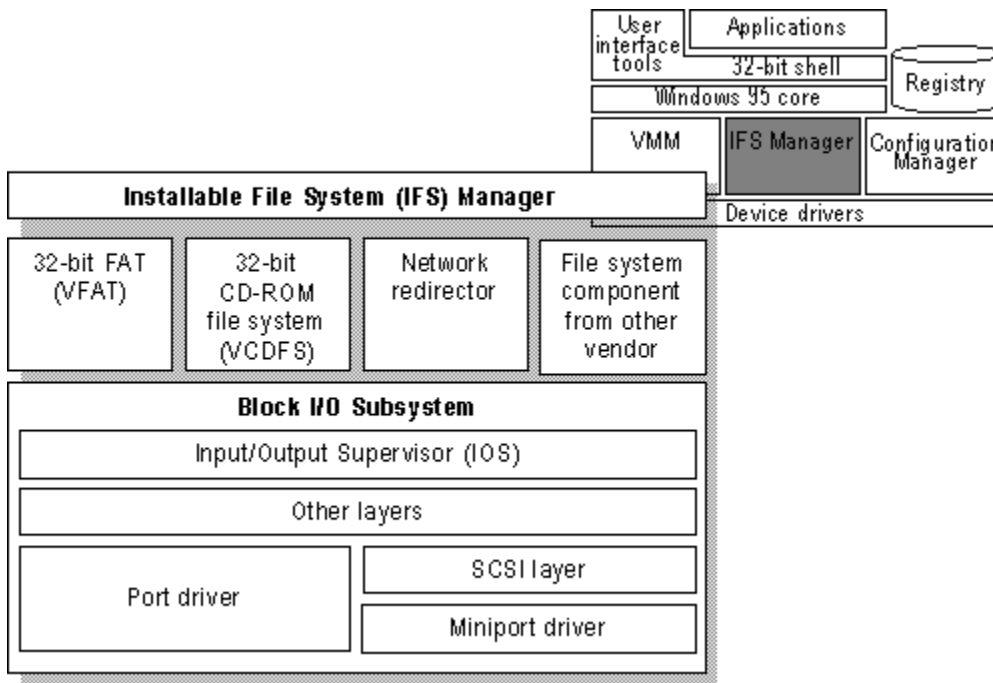

The Windows 95 file system architecture is made up of the following components:

- Installable File System (IFS) Manager. The IFS Manager is responsible for arbitrating access to different file system components.
- File system drivers. The file system driver layer includes access to FAT-based disk devices, CD-ROM file systems, and redirected network device support.
- Block I/O subsystem. The block I/O subsystem is responsible for interacting with the physical disk device.

The following sections describe these components.

Installable File System Manager

In Windows 95, the key to access of disk and redirected devices is the Installable File System (IFS) Manager. The IFS Manager arbitrates access to file system devices, and other file system device components.

Under MS-DOS and Windows 3.1, INT 21 provided access to the file system to manipulate file information on a disk device. To support redirected disk devices (for example, a network drive or a CD-ROM drive), other system components such as the network redirector would hook the INT 21 function so that it could examine the file system request to determine whether it should handle the file I/O request or let the base file system handle it. Although this mechanism provided the ability to add more device drivers, some add-on components ran improperly and interfered with other installed drivers.

Another problem with the MS-DOS-based file system was the difficulty in loading multiple network redirectors to provide concurrent access to different network types. Windows for Workgroups provided support for running the Microsoft Windows Network redirector at the same time as an additional network redirector such as Novell® NetWare® or Banyan® VINES®; however, support for running more than two network redirectors at the same time was not supported. In Windows 95, the network redirectors are implemented as file systems under IFS Manager, so an unlimited number of 32-bit redirectors can be used.

Windows 95 Architecture

Installable File Systems

File System Drivers

With Windows 3.1, file system drivers were supported by MS-DOS. With Windows 95, file system drivers are Ring 0 components of the operating system. Windows 95 includes support for all of the following file systems (others can be added by other vendors):

- 32-bit FAT (VFAT) driver
- 32-bit CD-ROM file system (CDFS) driver
- 32-bit network redirector for connectivity to Microsoft network servers such as Windows NT Server, along with a 32-bit network redirector to connect to Novell NetWare servers

For information about network redirectors, see [Windows 95 Network Architecture](#).

VFAT File System

The 32-bit VFAT driver provides a protected-mode code path for manipulating the file system stored on a disk. Because it is reentrant and multithreaded, it provides smoother multitasking performance.

The 32-bit VFAT driver interacts with the block I/O subsystem to provide disk access to more device types than are supported by Windows 3.1. Windows 95 also supports mapping to any real-mode disk drivers that might be installed. The combination of 32-bit file access and 32-bit disk access drivers results in significantly improved disk and file I/O performance.

Benefits of the 32-bit file access driver over MS-DOS-based driver solutions include the following:

- Dramatically improved performance and real-mode disk caching software
- No conventional memory used (real-mode SMARTDrive has been replaced)
- Better multitasking when accessing information on disk
- Dynamic cache support

Both MS-DOS and Windows 3.1 used 16-bit real-mode code to manipulate the file allocation table (FAT) and to read to and write from the disk. Being able to manipulate the disk file system from protected mode removes or reduces the need to switch to real mode to write information to the disk through MS-DOS, thus resulting in a performance gain for file I/O access.

The 32-bit VFAT works with a 32-bit, protected-mode cache driver (VCACHE). This driver replaces the 16-bit, real-mode SMARTDrive disk cache software provided with MS-DOS and Windows 3.1. The VCACHE driver features better caching algorithms than SMARTDrive, to cache information read from or written to a disk drive. The VCACHE driver also manages the cache pool for the CD-ROM File System (CDFFS) and the 32-bit network redirectors provided with Windows 95.

Another big improvement in VCACHE over SMARTDrive is that the memory pool used for the cache is dynamic and is based on the amount of available free system memory. Users no longer need to allocate a block of memory as a disk cache. The system automatically allocates or deallocates memory used for the cache based on system use.

For example, as you perform a large number of activities on the network, Windows 95 increases the size of the cache. As network activity decreases and more applications are started, Windows 95 decreases the cache size.

CD-ROM File System

The 32-bit, protected-mode CDFS implemented in Windows 95 provides improved CD-ROM access and performance over the real-mode MSCDEX driver in Windows 3.1. (CDFS conforms to the ISO 9660 standard.) The CDFS driver cache is also dynamic, requiring no configuration or static allocation on the part of the user. For information about the CD-ROM cache, see [Performance Tuning](#).

Benefits of the new 32-bit CDFS driver include the following:

- No conventional memory used (real-mode MSCDEX has been replaced)
- Improved performance over MS-DOS-based MSCDEX and real-mode cache
- Better multitasking when accessing CD-ROM information
- Dynamic cache support to provide a better balance between providing memory to run applications versus providing memory to serve as a disk cache

MSCDEX is no longer necessary under Windows 95, and is automatically removed from memory and from AUTOEXEC.BAT by Setup, and the 32-bit CDFS driver is used instead.

Block I/O Subsystem

The block I/O subsystem in Windows 95 improves upon the 32-bit disk access “FastDisk” device architecture used in Windows 3.1 to enhance performance for the entire file system and provides a broader array of device support.

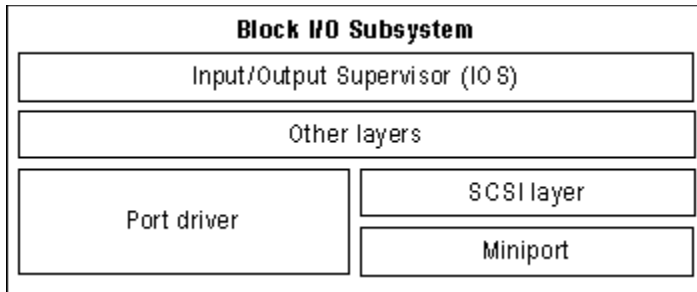

As shown in the preceding diagram, the block I/O subsystem includes the following components.

Input/Output Supervisor (IOS).

This component provides services to file systems and drivers. The IOS is responsible for the queuing of file service requests and for routing the requests to the appropriate file system driver. The I/O Supervisor also provides asynchronous notification of file system events to drivers. This component is described further in the following section.

Port driver.

This is a monolithic, 32-bit, protected-mode driver that communicates with a specific disk device such as a hard disk controller. This driver is Windows 95-specific and resembles the 32-bit disk access driver used in Windows 3.1 (for example, WDCTRL for Western Digital™-compatible hard disk controllers). In Windows 95, the driver that communicates with IDE or ESDI hard disk controllers and floppy disk controllers is implemented as a port driver. A port driver provides the same functionality as the combination of the SCSI manager and the miniport driver.

SCSI layer.

This component applies a 32-bit, protected-mode, universal driver model architecture for communicating with SCSI devices. The SCSI layer provides all the high-level functionality common to SCSI and similar devices, and then uses a miniport driver to handle device-specific I/O calls. The SCSI Manager is also part of this system and provides the compatibility support for using Windows NT miniport drivers.

Miniport driver.

The Windows 95 miniport driver model makes it easier for a hardware disk device vendor to write a device driver. Because the SCSI stub provides the high-level functionality for communicating with SCSI devices, the hardware disk device vendor only needs to create a miniport driver tailored to the vendor's own disk device. The Windows 95 miniport driver is 32-bit protected-mode code, and is binary-compatible with Windows NT miniport drivers. However, older miniport drivers written for Windows NT do not include Plug and Play information and, therefore, will not perform well on Windows 95.

In addition to these other layers, the Block I/O subsystem provides a real-mode mapping layer. This layer provides compatibility with real-mode, MS-DOS-based device drivers for which a protected-mode counterpart does not exist. This layer allows the protected-mode file system to communicate with a real-mode driver as if it were a protected-mode component.

The layers above the Block I/O and the real-mode mapper are protected-mode code, and the real-mode mapper translates file I/O requests from protected mode to real mode, such that the MS-DOS-based device driver can perform the appropriate operation to write or read information to or from the disk device. For example, the real-mode mapper is used when real-mode disk compression software is running and a protected-mode disk compression driver is not available.

Note Using MS-DOS-based device drivers can be a potential bottleneck because all I/O must be

serialized. Also, because all of these VxDs must be page-locked, this increases the working set used by the operating system.

I/O Supervisor and Driver Loading

The I/O Supervisor is a required system VxD that carries out all control and management tasks for the protected-mode file system and block device drivers in Windows 95. The I/O Supervisor loads and initializes protected-mode device drivers and provides services needed for I/O operations.

The I/O Supervisor receives requests from VFAT and CDFS file systems and loads the drivers for accessing local disk devices and drives, including SCSI and IDE. It supports WD1003-compatible drivers, takes control of real-mode drivers, and provides a mapper for real-mode drivers.

The real-mode mapper in the I/O Supervisor provides compatibility with real-mode MS-DOS device drivers for which protected-mode counterparts do not exist. For example, the real-mode mapper goes to work when real-mode disk compression software is running and a protected-mode disk compression driver is not available. This component ensures binary compatibility with existing MS-DOS-based disk device drivers in Windows 95.

The I/O Supervisor was first implemented in Windows 3.x as *BLOCKDEV, and in Windows 95 it also provides *BLOCKDEV services for older 32-bit disk access drivers. New responsibilities for the I/O Supervisor include:

- Registering drivers
- Routing and queuing I/O requests, and sending asynchronous notifications to drivers as needed
- Providing services that drivers can use to allocate memory and complete I/O requests

Windows 95 loads and initializes the I/O Supervisor as specified in a **device=** entry in SYSTEM.INI. The I/O Supervisor is initialized before clients and virtual device drivers such as APIX and *INT13, so clients and virtual device drivers can call services in the I/O Supervisor to register and carry out tasks.

To load and initialize port drivers, miniport drivers, and value-added drivers, the I/O Supervisor requires the files for these drivers to be stored in the SYSTEM\IOSUBSYS directory with the following filename extensions.

Filename extension	Description
PDR	Port drivers, such as SCSI\PORT, ESDI_506, and NEC
MPD	Miniport drivers
386 or VXD	Value-added drivers, such as the volume tracker and vendor-supplied drivers

The SYSTEM\IOSUBSYS directory is reserved for device drivers specifically designed to be used with the I/O Supervisor. Other clients or virtual device drivers should be stored in other directories and explicitly loaded using **device=** entries in SYSTEM.INI.

The I/O Supervisor initializes device drivers (as described in the following sections) from the bottom layer upwards, so port drivers are initialized before vendor-supplied drivers, vendor-supplied drivers before type-specific drivers, and so on. Value-added drivers are initialized in groups, layer by layer, with all drivers in one layer initialized before drivers in the next layer. The initialization order within a layer is not defined, so you cannot depend on the drivers in a group being initialized in a specific order or even that the order remains between startup operations.

For Plug and Play detection, the I/O Supervisor loads a specific port or miniport driver only if Configuration Manager requests that the driver be loaded after hardware detection locates an adapter.

Core System Components

Similar to Windows version 3.1 and Windows for Workgroups version 3.1, Windows 95 includes a core composed of three components — User, Kernel, and graphical device interface (GDI).

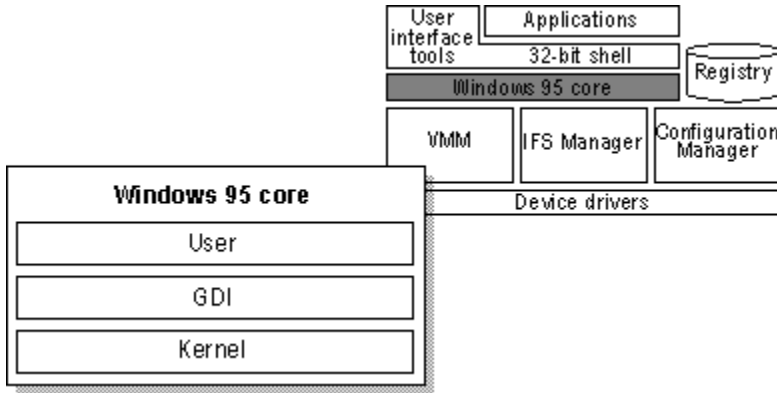

Each of these components includes a pair of DLLs — one 32-bit and one 16-bit — which provide services for the applications you run. Windows 95 is designed to use 32-bit code wherever it significantly improves performance without sacrificing application compatibility. Windows 95 retains existing 16-bit code where it is required to maintain compatibility or where 32-bit code would increase memory requirements without significantly improving performance. All the Windows 95 I/O subsystems (such as networking and file systems) and device drivers are 32-bit, as are all the memory management and scheduling components, including the Kernel and Virtual Memory Manager.

As shown in the following illustration, the lowest-level services provided by the Windows 95 Kernel are implemented as 32-bit code to ensure a high-performance core. Most of the remaining 16-bit code consists of hand-tuned assembly language, delivering performance that rivals some 32-bit code used by other operating systems.

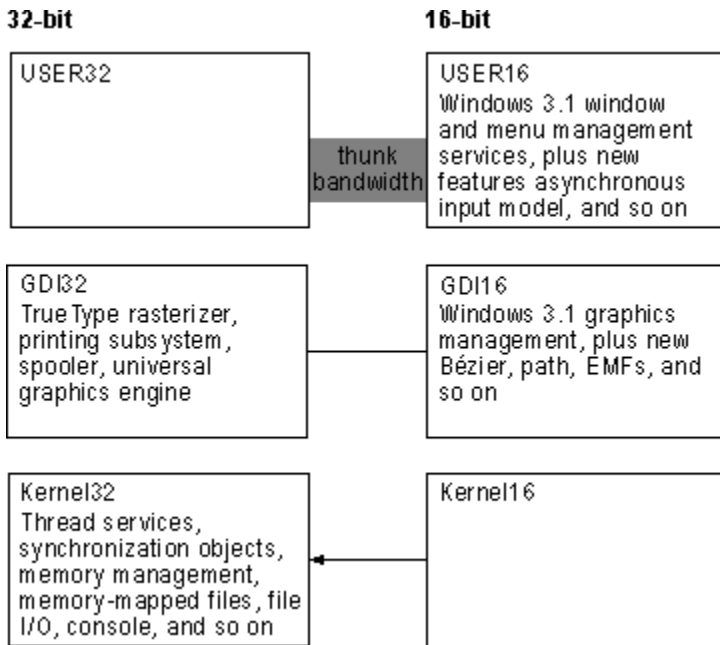

Many functions provided by the GDI — which are mostly complex, CPU-intensive functions — are now rewritten as 32-bit code to improve performance. Much of the window management code in the User components — which are small, fast functions — remains 16-bit, thus retaining application compatibility.

Windows 95 also improves on the MS-DOS and Windows 3.1 environments by implementing many device drivers as 32-bit, protected-mode code. Virtual device drivers in Windows 95 assume the functionality provided by many real-mode MS-DOS-based device drivers, eliminating the need to load them in MS-DOS. This results in a minimal conventional memory footprint, improved performance, and improved reliability and stability of the system over real-mode device drivers.

The following sections describe the services provided by these core components.

User

The User component manages input from the keyboard, mouse, and other input devices and output to the user interface (windows, icons, menus, and so on). It also manages interaction with the sound driver, timer, and communications ports.

Windows 95 uses an asynchronous input model for all input to the system and applications. As the various input devices generate interrupts, the interrupt handler converts these interrupts to messages and sends the messages to a raw input thread area, which in turn passes each message to the appropriate message queue. Although each Win32-based thread can have its own message queue, all Win16-based applications share a common message queue.

Kernel

The Kernel provides base operating system functionality including file I/O services, virtual memory management, and task scheduling. When a user wants to start an application, the Kernel loads the EXE and DLL files for the application.

Exception handling is another service of the Kernel. *Exceptions* are events that occur as a program runs and that require software outside of the normal flow of control to be run. For example, if an application generates an exception, the Kernel is able to communicate that exception to the application to perform the necessary functions to resolve the problem.

The Kernel also allocates virtual memory, resolves import references, and supports demand paging for the application. As the application runs, the Kernel schedules and runs threads of each process owned by an application.

The Kernel provides services to both 16-bit and 32-bit applications by using a translation process called *thunking* to map between 16-bit and 32-bit formats. Thunking converts a 16-bit value to its 32-bit equivalent.

Virtual Memory Management

Virtual memory is a term that refers to the fact that the operating system can actually allocate more memory than the computer physically contains. Each process is allocated a unique virtual address space, which is a set of addresses available for the process's threads to use. This virtual address space appears to be 4 GB in size — 2 GB reserved for program storage and 2 GB reserved for system storage.

The following diagram illustrates where Windows 95 system components and applications reside in virtual memory.

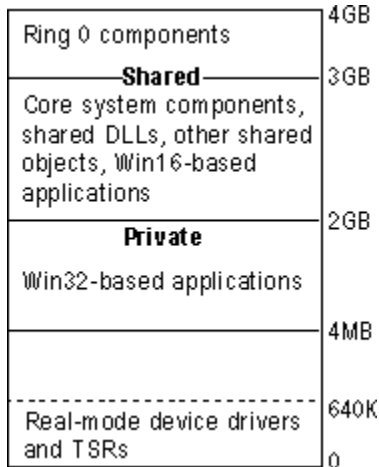

From top to bottom, here's where system and application components reside in virtual memory:

- All Ring 0 components reside in the address space above 3 GB.
- The Windows 95 core components and shared DLLs reside in the shared address space between 2 GB and 3 GB. This makes them available to all applications.
- Win32-based applications reside between 4 MB and 2 GB. Each Win32-based application has its own address space, which means that other programs cannot corrupt or otherwise hinder the application, or vice versa.

Windows 95 Swap File

The Windows 95 virtual memory swap file implementation addresses the problems and limitations imposed in Windows 3.1.

Under Windows 3.1, users had to decide whether to use a temporary swap file or a permanent swap file, how much memory to allocate to the swap file, and whether to use 32-bit disk access to access the swap file. Users benefited from a temporary swap file in that the swap file did not need to be contiguous; Windows allocated space on the hard disk when the user started Windows, and freed up the space when the user exited Windows. A permanent swap file provided better performance; however, it required a contiguous block of space on a physical hard disk, and was static, so it did not free up space when the user exited Windows.

The swap file implementation in Windows 95 simplifies the configuration task for the user and combines the best of temporary and permanent swap files, due to improved virtual memory algorithms and access methods. The swap file in Windows 95 is dynamic; it can shrink or grow, based on the operations that are performed on the system. The swap file can also occupy a fragmented region of the hard disk with no substantial performance penalty. The swap file can also reside on a compressed volume.

You can still adjust the parameters used for defining the swap file in Windows 95; however, the need to do this is reduced by using system defaults. For information about swap file configuration options, see [Performance Tuning](#).

Windows 95 Architecture

Core System Components

Graphical Device Interface

The Graphical Device Interface (GDI) is the graphical system that manages what appears on the screen. It also provides graphics support for printers and other output devices. It draws graphic primitives, manipulates bitmaps, and interacts with device-independent graphics drivers, including those for display and printer output device drivers.

Graphics Subsystem

The graphics subsystem provides graphics support for input and output devices.

To gain reliability and better performance, Microsoft developed a new 32-bit graphics engine (also known as the Device Independent Bitmaps, or DIB, engine). This engine directly controls graphics output to the screen, which results in more reliable system performance. It also provides a set of optimized generic drawing functions for monochrome, 16-color, 16-bit high color, 256-color, and 24-bit true color graphic devices, and supports Bézier curves and paths.

The graphics subsystem supports Image Color Matching for better color-matching between display and color output devices. With Image Color Matching in Windows 95, users can see a better match between the colors displayed on the screen and the colors printed on a color printing device. Image Color Matching is implemented as a service within Windows 95. Applications can use the corresponding APIs and DLL to take advantage of Image Color Matching features.

As with other parts of the operating system, the Windows 95 graphics subsystem includes a universal driver/mini-driver model. As illustrated in the following, display drivers for Windows 3.1 included hardware-specific instructions, in addition to general instructions for the operating system. Now, all instructions about drawing to the screen or output device are included in the universal display driver. Mini-drivers for Windows 95 define only hardware-specific instructions. Mini-drivers are available for most leading Super VGA adapters and graphics accelerators, including S3, ATI, Tseng, Paradise, Western Digital, and Cirrus Logic.

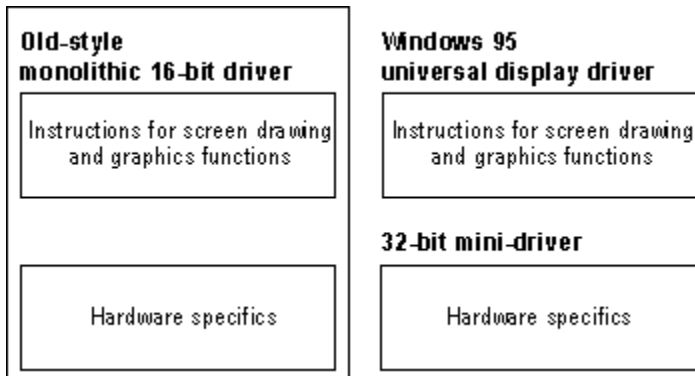

Tip Problems can result when Windows 95 assumes that a display adapter can support certain functionality that, in fact, it cannot. If this occurs, the side effects might be anything from small display irregularities to system lockup.

To determine whether any performance problems might be related to the display adapter, you can progressively disable enhanced display functionality using the System option in Control Panel. For information, see [Performance Tuning](#).

Printing Subsystem

The 32-bit Windows 95 printing subsystem improves performance through smoother background printing and faster return-to-application time. The Windows 95 spooler passes data to the printer as the printer is ready to receive more information, by using background thread processing.

Windows 95 spools enhanced metafile (EMF) format files, rather than raw printer data, to ensure quick return-to-application time (as much as two times faster than with Windows 3.1). When spooled, the EMF information is interpreted in the background, and the output is sent to the printer.

The printing subsystem supports Point and Print. When users browse the network to choose the printers they want to use, Windows 95 automatically installs the appropriate printer driver from the Windows 95 or Windows NT server.

Another feature of the Windows 95 printing subsystem is deferred printing. If no printing device is available, the user can still “print” the job. Windows 95 generates the print job, then saves it for output to the print device when one is available. Then, when the user docks the portable computer after returning to the office, the print job that was “printed” begins generating pages at the print device.

The printing subsystem also provides system-level support of bidirectional communication protocols for printers adhering to the Extended Communication Port (ECP) printer communication standard, developed by Microsoft and Hewlett-Packard. This capability allows printers to send unsolicited messages to Windows 95 and to applications. For example, the printer might send an “out of paper” or “printer offline” message. Bidirectional communication enables much more detailed status reporting on a wider variety of information, such as information about a low toner condition, details about a paper jam, instructions related to maintenance needs, and so on.

User Interface

Windows 95 features a 32-bit user interface shell, based on Windows Explorer. This shell contains several desktop tools, including Network Neighborhood. As shown in the following figure, these tools run at the same level as other Win32-based, Win16-based, and MS-DOS-based applications.

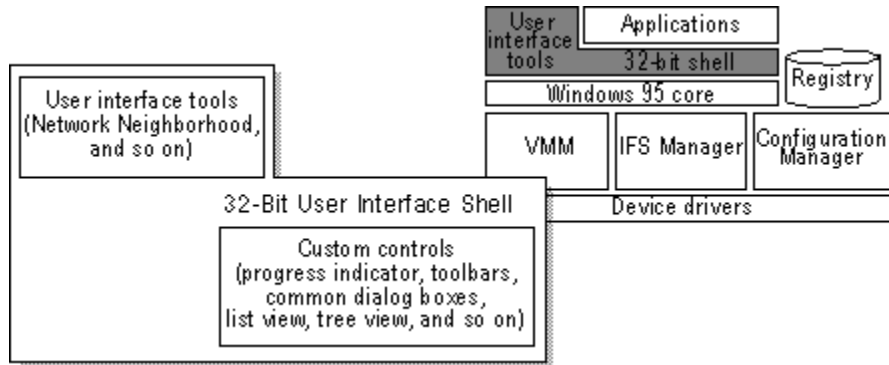

All applications and tools can take advantage of the common controls offered by the shell, such as common dialog boxes, tree views, and list views.

Application Support

Windows 95 supports Win32-based, Win16-based, and MS-DOS-based applications.

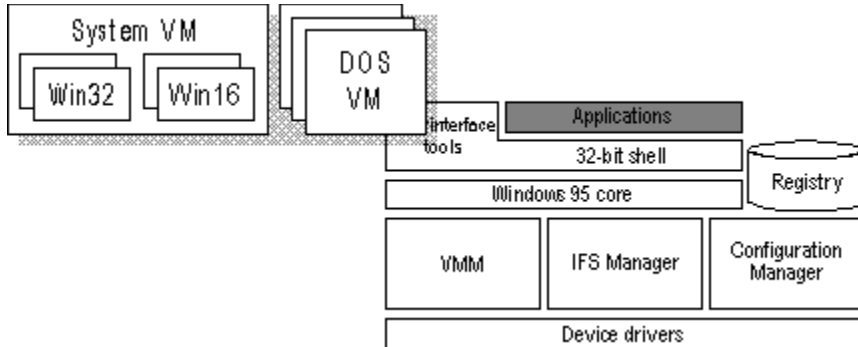

As illustrated here, Win32-based and Win16-based applications run in the System VM. Win32-based applications each run in a separate address space, while Win16-based applications run together in a shared address space. Each MS-DOS-based application runs in its own VM.

For details about using Win32-based, Win16-based, and MS-DOS-based applications in Windows 95, see [Application Support](#). For more information about VMs, see [Virtual Machine Manager](#).

Introduction

This chapter presents information about the architecture for the networking components in Windows 95.

- Windows 95 Network Architecture Overview
 - OSI Reference Model and Windows 95 Architecture
 - Redirectors and IFS Manager
- Multiple Network Support
 - Win32 WinNet Interface for Applications
 - Multiple Provider Router and Service Provider Interface
 - Network Providers
 - WinNet16 Interface
 - Multiple Network Example
- NDIS Overview
 - Support for NDIS 2 Protocols
 - Support for NDIS Network Adapters
- Architecture for Network Protocols
 - Architecture for IPX/SPX-Compatible Protocol
 - Architecture for NetBEUI Protocol
 - Architecture for Microsoft TCP/IP Protocol
- Architecture for Clients, Peer Servers, and IPC
 - Client for Microsoft Networks Architecture
 - Client for NetWare Networks Architecture
 - Architecture for Peer Resource Sharing
 - IPC and Windows 95

Windows 95 Network Architecture Overview

Windows 95 provides multiple, simultaneous connections to a variety of networks (Windows NT, Novell® NetWare®, and others) and a variety of resources (files, programs, printers, host systems, and mail systems) over most popular media (Ethernet, token ring, X.25, ISDN) from almost any location.

Windows 95 networking capabilities are implemented using a high-performance, reliable, and open architecture based on the Windows Open Services Architecture (WOSA) specification. This approach provides users with a consistent interface to different services on the front end, while giving system administrators the flexibility to mix and match multiple services on the back end.

OSI Reference Model and Windows 95 Architecture

The modular networking architecture of Windows 95 is based on two industry standard models for a layered networking architecture, namely the International Organization for Standardization (ISO) model for computer networking, called the Open Systems Interconnect (OSI) Reference Model, and the Institute of Electrical and Electronic Engineers (IEEE) 802 model. Windows NT and Windows for Workgroups are also designed according to these standard models. The ISO OSI and IEEE 802 models define a modular approach to networking, with each layer responsible for some discrete aspect of the networking process.

The OSI model describes the flow of data in a network, from the lowest layer (the physical connections) up to the layer containing the user's applications. Data going to and from the network is passed layer to layer. Each layer is able to communicate with the layer immediately above it and the layer immediately below it. This way, each layer is written as an efficient, streamlined software component. When a layer receives a packet of information, it checks the destination address, and if its own address is not there, it passes the packet to the next layer.

When two computers communicate on a network, the software at each layer on one computer assumes it is communicating with the same layer on the other computer. For example, the Transport layer of one computer communicates with the Transport layer on the other computer. The Transport layer on the first computer has no regard for how the communication actually passes through the lower layers of the first computer, across the physical media, and then up through the lower layers of the second computer.

The OSI Reference Model includes seven layers:

- The *Application layer* represents the level at which applications access network services. This layer represents the services that directly support applications such as software for file transfers, database access, and electronic mail.
- The *Presentation layer* translates data from the Application layer into an intermediary format. This layer also manages security issues by providing services such as data encryption, and compresses data so that fewer bits need to be transferred on the network.
- The *Session layer* allows two applications on different computers to establish, use, and end a session. This layer establishes dialog control between the two computers in a session, regulating which side transmits, plus when and how long it transmits.
- The *Transport layer* handles error recognition and recovery. It also repackages long messages when necessary into small packets for transmission and, at the receiving end, rebuilds packets into the original message. The receiving Transport layer also sends receipt acknowledgments.
- The *Network layer* addresses messages and translates logical addresses and names into physical addresses. It also determines the route from the source to the destination computer and manages traffic problems, such as switching, routing, and controlling the congestion of data packets.
- The *Data Link layer* packages raw bits from the Physical layer into frames (logical, structured packets for data). This layer is responsible for transferring frames from one computer to another, without errors. After sending a frame, it waits for an acknowledgment from the receiving computer.
- The *Physical layer* transmits bits from one computer to another and regulates the transmission of a stream of bits over a physical medium. This layer defines how the cable is attached to the network adapter and what transmission technique is used to send data over the cable.

The following diagram shows the layered components that make up the Windows 95 networking model.

Layers in the Windows 95 networking model

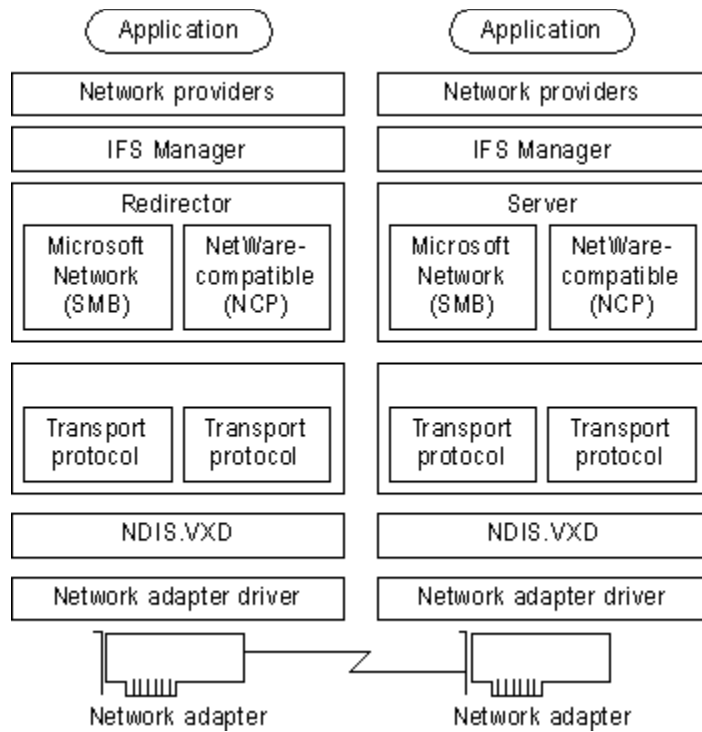

The following sections describe these elements of the Windows 95 network architecture, beginning with redirectors. Network providers are described in [Multiple Network Support](#).

Redirectors and IFS Manager

A network redirector provides mechanisms to locate, open, read, write, and delete files and submit print jobs. It also makes available application services such as named pipes and mailslots. When an application needs to send or receive data from a remote device, it sends a call to the redirector. The redirector provides the functionality of the Application and Presentation layers of the OSI model.

The redirectors are included in the Windows 95 network client software as the following file system drivers:

- In Client for Microsoft Networks (VREDIR.VXD), the redirector supports all networks based on Microsoft networking, which use the Server Message Block (SMB) file sharing protocol.
- In Microsoft Client for NetWare Networks (NWREDIR.VXD), the redirector supports NetWare networking products, which use the NetWare Core Protocol (NCP) file sharing protocol.

Windows 95 also supports network redirectors from other network vendors.

Because each protected-mode redirector is implemented in Windows 95 as a file system driver, the redirector is managed by Installable File System (IFS) Manager. The redirector works with IFS Manager to map local names into network devices and decides whether the application needs access to a local or remote device. IFS Manager controls file I/O transfers for all the installable file systems in Windows 95. For more information about IFS Manager, see [Windows 95 Architecture](#).

Client for Microsoft Networks (the redirector for Microsoft networks) formats an application's request into data packet SMBs and submits the packet to the protocol. Microsoft Client for NetWare Networks (the NetWare redirector) formats requests into NCP packets. The data packet is passed by the protocol to the adapter driver.

The Windows 95 server side at this layer of the networking model supports peer resource sharing. Windows 95 provides two server services for peer networking:

- File and Printer Sharing for Microsoft Networks (the Windows 95 SMB-based server, VSERVER.VXD), which supports resource sharing among all computers on the network that use the SMB file sharing protocol.
- File and Printer Sharing for NetWare Networks (the Windows 95 NCP-based server, NWSERVER.VXD), which supports resource sharing among all computers on the network that use the NCP file sharing protocol.

Multiple Network Support

The Windows 95 modular network provider interface, as described in this section, supports concurrent communication with several different networks. For example, a computer can have connections to computers running Windows 95 peer resource-sharing services, to servers for Windows NT and NetWare networks, and to the Internet, all at the same time.

In addition to the Windows 95 network client and peer sharing components, Windows 95 includes built-in support for the following network clients from other vendors:

- Artisoft® LANtastic® version 5.0 and later
- Banyan® VINES® version 5.52 and later
- DEC™ PATHWORKS™ (installed as a protocol)
- Novell® NetWare® version 3.11 and later
- SunSoft™ PC-NFS® version 5.0 and later

Most of these network clients can be installed along with protected-mode Windows 95 networking components. Windows 95 does not include the supporting files for these networks; you must obtain them from the network vendor. For information about these network clients, see [Windows 95 on Other Networks](#).

Multiple network support in Windows 95 consists of these components, as described in the following sections:

- Win32 WinNet API
- Multiple provider router and service provider interface
- Network providers (including the WinNet16 interface)

Components of multiple network support in Windows 95

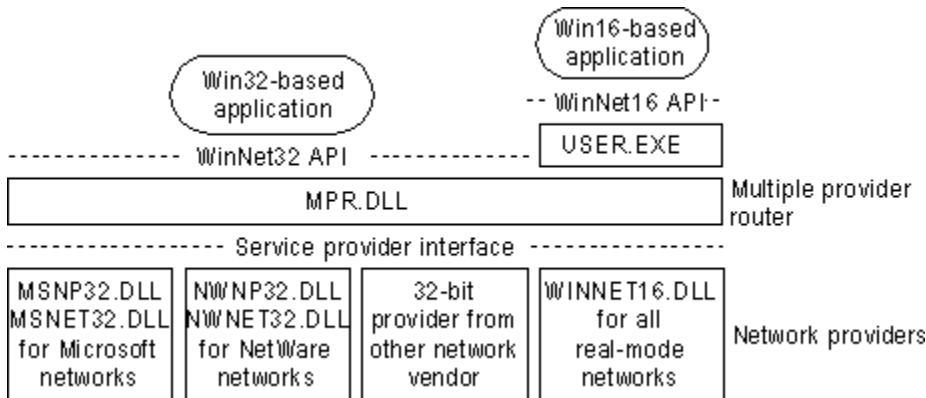

Win32 WinNet Interface for Applications

The Win32 WinNet interface in Windows 95 provides an API that software developers can use to create single versions of applications that run unmodified on different networks. The Win32 WinNet interface is the successor to the WinNet16 interface introduced in Windows 3.0 and enhanced in Windows 3.1.

The expanded WinNet API set includes the following:

- Support for the Win32 WinNet APIs as defined in Windows NT. This set of functions and the other Win32 APIs provide all the commonly used capabilities required by applications.
- Support for the Win32 WinNet APIs for browsing network resources (directories, printers, and other resources). This includes consistent handling of authentication requirements across multiple networks and support for the NetWare server security model.
- Backward compatibility with Windows for Workgroups 3.11 and support for networks that use a WinNet16 network driver.

Multiple Provider Router and Service Provider Interface

The multiple provider router in Windows 95 exports the Win32 WinNet APIs to applications. It provides seamless access to network services and resources, and it supports a way to access a single WinNet16 network driver. It routes incoming network requests to the appropriate network provider, using the same interface whether one or more network providers are installed.

Features common to all networks are implemented once in the multiple provider router, which reduces the code base for each network provider and ensures common behavior among networks. For example, network providers do not implement persistent connections — this feature is implemented in the multiple provider router and is entirely transparent to a network provider.

Windows 95 uses an open, modular service provider interface (SPI) to allow multiple 32-bit network providers to be installed in Windows 95 simultaneously. The service provider interface is a single, well-defined set of functions used by Windows 95 to request network services to browse servers, connect to and disconnect from servers, and so on. The multiple provider router communicates with the network providers using the service provider interface.

The service provider interface provides the needed network services to honor a Windows 95 request for network-specific services. This model is similar to the Windows 95 design for various device driver interfaces: a well-defined set of interfaces used by the operating system, with services provided by a device driver (often written by another vendor) to honor requests. These requests are then passed to the network providers.

The service provider interface enables Microsoft or other network providers to integrate varied network services seamlessly into Windows 95. The service provider interface ensures that all supported networks are identically accessed and managed through Network Neighborhood and other user interface components.

Network Providers

Windows 95 uses an open, modular network provider interface to allow multiple network support simultaneously. Key benefits of the network provider interface architecture are the following:

- An open interface allowing any network vendor to supply tightly integrated support for Windows 95.
- Identical access to and management of network resources and components through the Windows 95 user interface, including Network Neighborhood and the Network option in Control Panel.

The network provider API calls are used by applications to request network services. Windows 95 passes a network provider call to the appropriate network provider, which then supplies the requested network service.

The network provider is a network-specific driver that implements the service provider interface call from the multiple provider router. The functions provided include authenticating users when they access a network server, managing passwords, adding or removing server connections, and browsing network resources.

Windows 95 includes the following network providers:

- MSNP32.DLL for Microsoft networks
- NWNP32.DLL for NetWare networks
- WINNET16.DLL to support a single 16-bit network provider that uses WinNet16 APIs

Windows 95 also supports any number of other 32-bit network providers. Such network providers must be supplied by other network vendors.

The Windows 95 system logon is an example of a network service provided by the network provider interface. Each network provider can provide a unique logon dialog box to suit the needs of its network server security model. After the logon is validated by the requested server, this is passed back to Windows 95, which can then use this password to unlock any network resource linked to the logon validation. In this way, Windows 95 can accommodate the various ways that network servers provide their services, yet still offer a consistent user interface.

The following summarizes the internal processes when, for example, a user double-clicks the Entire Network icon in Network Neighborhood:

1. The Windows 95 user interface generates a Win32-based network API call to enumerate servers and resources on the network.
2. The multiple provider router receives the API call and submits a service provider interface call to all the available network providers.
3. Each network provider browses its individual networks and returns the list to Windows 95, which displays all the networks and their hierarchies in the Entire Network window.

Because of the network provider support in Windows 95, users can specify server name strings in a drive connection dialog box using the syntax to which they are accustomed. A network provider knows how to correctly interpret the syntax of its own server name strings. The server name string is the syntax used by a particular network operating system to specify a shared disk resource. Microsoft network-compatible networks use the UNC format (`\\server_name\share_name`).

However, because the network provider knows how to interpret server name strings, users who are accustomed to using the NetWare server syntax (`server_name/volume_name:directory_name`) can type such server names wherever required in Windows 95 to access NetWare server resources. The Windows 95 user interface and the **net** command also support UNC names for connecting to NetWare resources.

Network Provider for NetWare Networks

The network provider that supports NetWare networks (NWNP32.DLL and its support library, NWNET32.DLL) provides access to NCP-based NetWare network resources using Windows Explorer, Network Neighborhood, and Control Panel, and other Windows-based applications.

Basic architecture for network provider for the NetWare networks

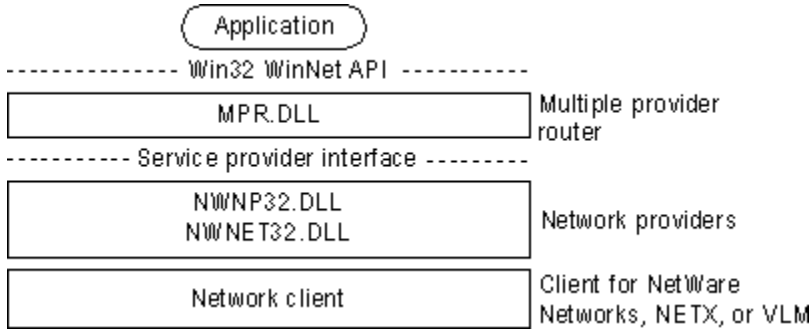

The network provider supports these functions on NetWare networks:

- Browsing NetWare networks. Bindery-based NetWare networks (versions 2.15 and above, 3.x, and 4.x with bindery emulation) use a Server-Volume-Directory hierarchy.
- Logging on to and off from a NetWare network, providing dialog boxes for network logon, and performing attachments to bindery-based servers.
- Adding and removing connections, allowing remote drive and printer connections using the NetWare format (*server/volume:*) and the UNC connections to NCP-based network resources (mapped drive or printer port, and *\\server\share*).

Network Provider for Microsoft Networks

The network provider that supports Microsoft networks (MSNP32.DLL) provides access to SMB-based Microsoft network resources using the Windows 95 user interface, such as Windows Explorer, Network Neighborhood, and Control Panel, and other Windows-based applications.

MSNP32.DLL provides the Microsoft network-specific dialog boxes (such as the Windows NT domain logon dialog box) and code to resolve a service provider interface call from the multiple provider router to a call to Client for Microsoft Networks.

Windows 95 architecture for the network provider for Microsoft networks

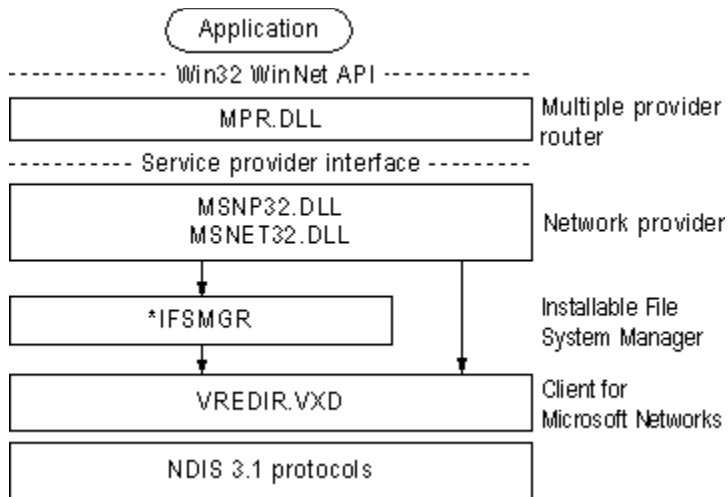

Notice that there are two arrows, one going through IFS Manager and one going directly to Client for Microsoft Networks.

- When a network request is for a generic function such as adding a connection, the call is submitted to the IFS Interface.
- When a network request is specific to a redirector, such as logging on or browsing a server, the call is sent to Client for Microsoft Networks.

The network provider supports these functions for Microsoft networking:

- Browsing Microsoft networks.
- Logging on to and off from a Windows NT or LAN Manager domain. The Microsoft network provider provides authentication services for validation by a domain controller, plus the ability to change the domain password using the Passwords option in the Windows 95 Control Panel.
- Adding or removing connections. The Microsoft network provider allows mapped drive and printer connections plus UNC connections to SMB-based network resources.

WinNet16 Interface

The WinNet16 interface is the earlier set of network-independent APIs introduced with Windows 3.0 and enhanced in Windows 3.1. WinNet16 provides simple functionality such as connecting to a drive letter or redirecting a printer port to a network printer. Windows 95 provides support for using a single WinNet16 driver.

If a network vendor provides a WinNet16 network driver developed for Windows 3.1 and has not written a 32-bit network provider and file system driver for Windows 95, using the WinNet16 interface and WINNET16.DLL is the only way to support that network in Windows 95. The WinNet16 driver that currently works with Windows 3.1 can be used without modification under Windows 95, using the WINNET16.DLL.

If Windows 95 Setup detects a Windows 3.x installation that uses a WinNet16 network driver and there is no 32-bit network provider available, Windows 95 Setup keeps the 16-bit network driver in place and provides network functionality with the 16-bit network driver installed as the primary network.

Multiple Network Example

In the following example, the user has installed two Windows 95 network clients (Client for Microsoft Networks and Client for NetWare Networks) and also has installed Banyan VINES support using a WinNet16 driver.

Banyan VINES uses the StreetTalk™ syntax (*file service@group@organization*) to specify server names. In trying to resolve the request to connect to Docs@Marketing@Corp from a network drive connection dialog box in Windows 95, the multiple provider router submits the request to all installed network providers. WINNET16.DLL receives the call and passes it on to VINES.DRV, which submits the drive connection request to the Banyan real-mode networking software through VVINESD.386.

This example shows a network drive connection request with multiple networks installed.

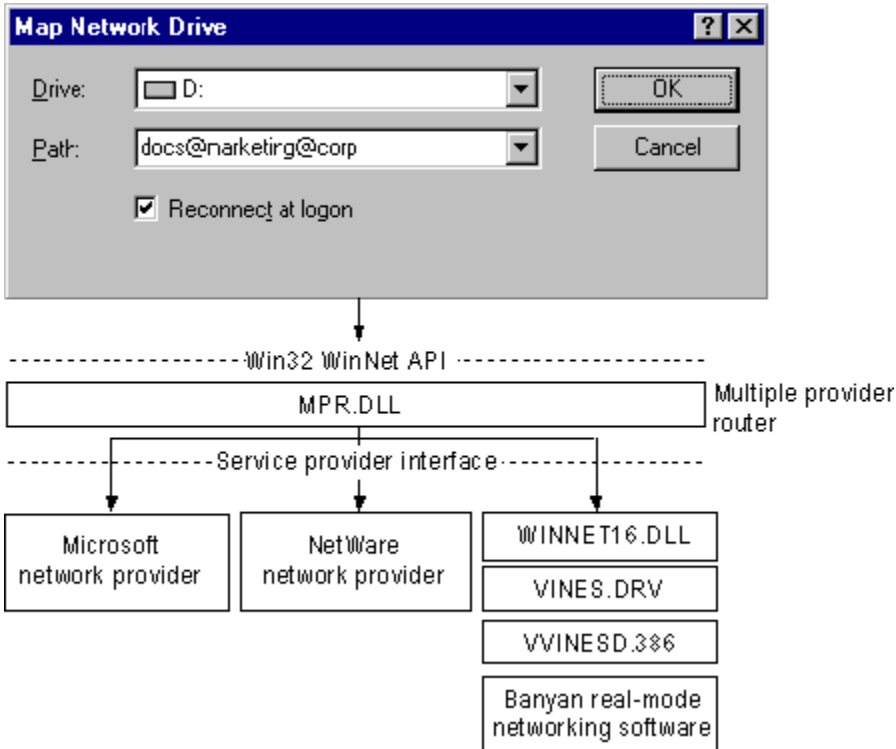

NDIS Overview

Windows 95 supports the Network Device Interface Specification (NDIS) 2.x and NDIS 3.1 protocol drivers. This section provides some technical background information about NDIS support in Windows 95.

Support for NDIS 2 Protocols

An NDIS 2.x protocol driver must use an NDIS 2.x network adapter driver. Both protocol drivers and network adapter drivers must load and bind in real mode before launching Windows 95.

Windows 95 architecture for NDIS 2 protocols

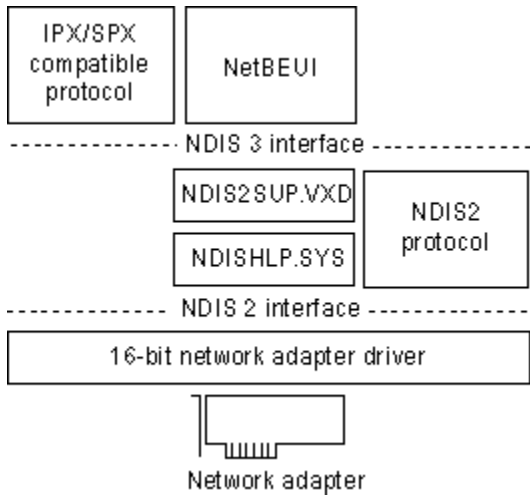

Support for NDIS Network Adapters

For NDIS 3.1 adapter mini-drivers, the mini-driver divides the existing NDIS media access control (MAC) layer into two halves and implements only the half specific to the network adapter. These include specific details such as establishing communications with the adapter, turning on and off electrical isolation for Plug and Play, providing media detection, and enabling any value-added features the adapter may contain. The mini-driver wrapper implements the other half of the MAC functionality that remains common to all NDIS drivers. In earlier releases of NDIS, each adapter driver carried all this redundant code, so mini-drivers are faster and are roughly 40 percent smaller than existing NDIS 3.x network adapter drivers.

Windows 95 architecture for NDIS 3.1 protocols

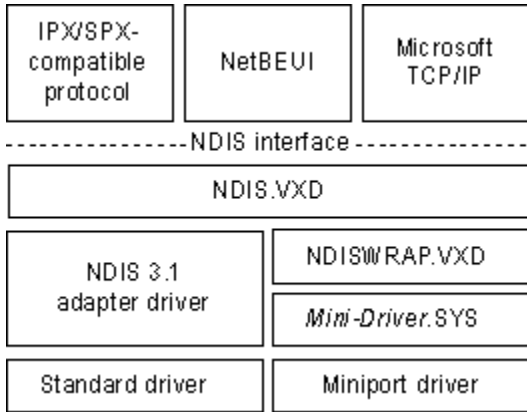

Windows 95 Network Architecture

Architecture for Network Protocols

Windows 95 includes support for IPX/SPX-compatible protocols and NetBEUI and TCP/IP. The following sections describe how support for each type of protocol is implemented in Windows 95.

Architecture for IPX/SPX-Compatible Protocol

The Microsoft IPX/SPX-compatible protocol uses the NWNBLINK.VXD module to support NetBIOS over IPX and to support the NetBIOS programming interface.

Windows 95 architecture for IPX/SPX-compatible protocol

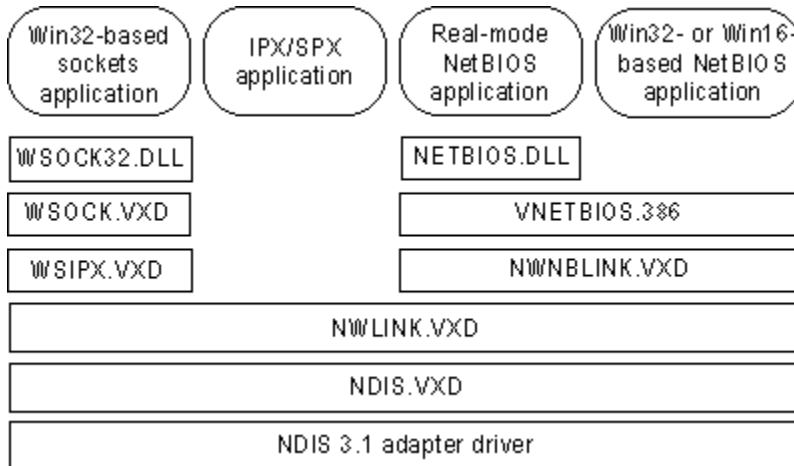

The Microsoft IPX/SPX-compatible protocol is NDIS 3.1-compliant, allowing computers running Windows 95 to communicate over a routable IPX-compatible protocol. This protocol can use Novell NetWare servers configured as routers (and other IPX routers) to transfer its packets across LANs to access resources on other computers running Windows 95.

Windows 95 Network Architecture
Architecture for Network Protocols

Architecture for NetBEUI Protocol

The NetBEUI module, NETBEUI.VXD, implements the NetBIOS framing protocol.

Windows 95 architecture for NetBEUI protocol

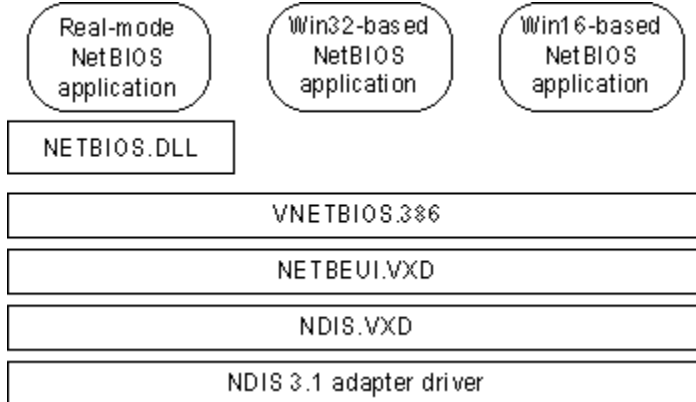

Architecture for Microsoft TCP/IP Protocol

TCP/IP is a popular routable protocol for wide-area networks. The TCP/IP module, VTCP.VXD, is accessible through the Windows Sockets interface or through the NetBIOS interface. For information about Windows Sockets and interprocess communication mechanisms, see [NetBIOS](#).

Windows 95 architecture for Microsoft TCP/IP

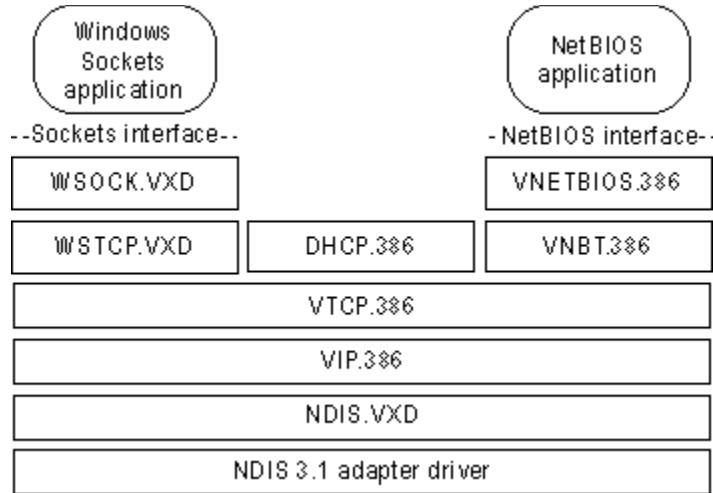

Architecture for Clients, Peer Servers, and IPC

You can install either or both of the 32-bit, protected-mode networking clients, Client for NetWare Networks and Client for Microsoft Networks. The following sections describe the architecture for these two clients and the related peer servers, plus information about the support for interprocess communications.

Architecture for Client for NetWare Networks with Client for Microsoft Networks

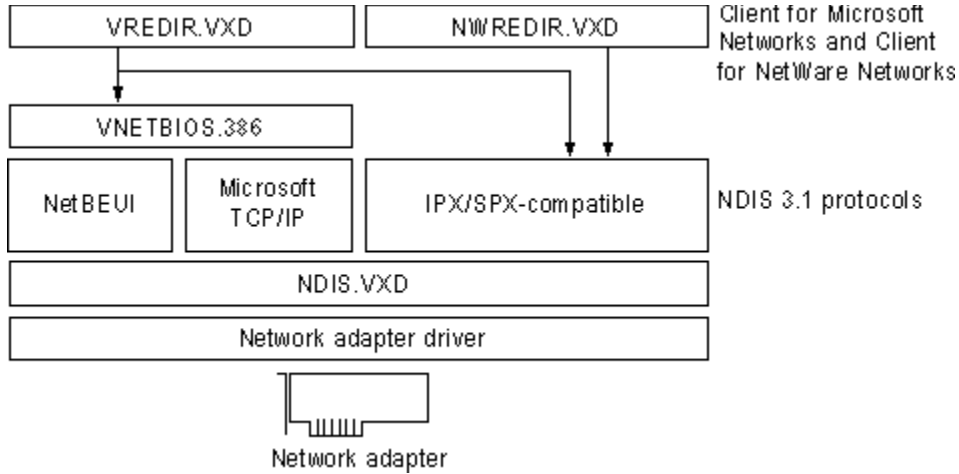

Client for Microsoft Networks Architecture

Windows 95 provides a 32-bit protected mode file system driver to support all Microsoft networking products that use the SMB file sharing protocol. This includes LAN Manager, Windows NT, Windows for Workgroups 3.x, Workgroup Add-on for MS-DOS, and Windows 95. Network products from other vendors using the Microsoft network standard are also supported, such as LAN Manager, IBM® LAN Server, and 3Com® 3+Open®.

Windows 95 architecture for Microsoft networking

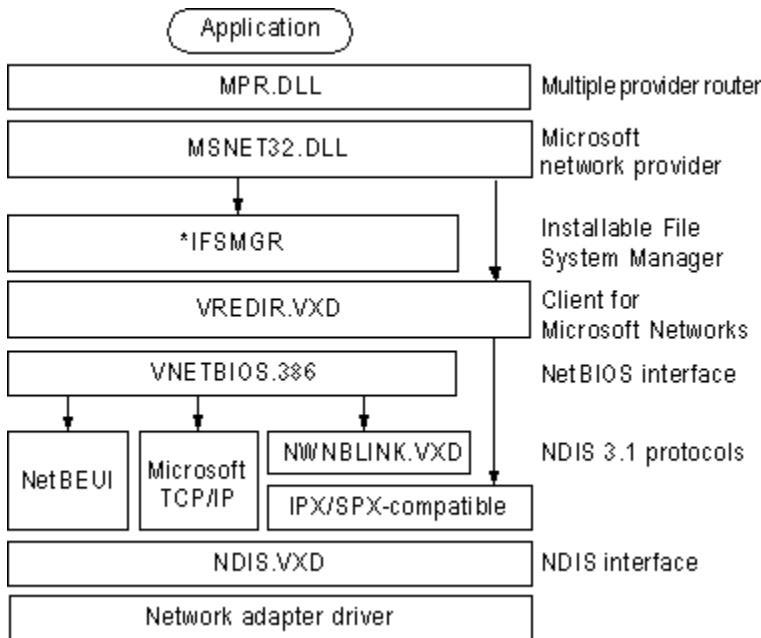

Client for Microsoft Networks supports connectivity over any NDIS protocol that supports a NetBIOS interface and is accessible through VNETBIOS.386. The protected-mode protocols provided with Windows 95 that support a NetBIOS interface are the following:

- NetBEUI using NETBEUI.VXD
- NetBIOS over TCP/IP using VNBT.VXD and the TCP/IP components, VTCP.VXD and VIP.VXD
- NetBIOS over IPX/SPX using NWNBLINK.VXD and NWLINK3.VXD

Client for Microsoft Networks also supports connectivity over IPX/SPX using NWLINK.VXD without the NetBIOS interface.

Windows 95 Network Architecture

Architecture for Clients, Peer Servers, and IPC

Client for NetWare Networks Architecture

You can use Client for NetWare Networks in an environment where all that is needed is a 32-bit client to connect to existing NetWare servers (for example, if there is no need for SMB-based peer resource sharing services).

Architecture for Client for NetWare Networks as the sole client

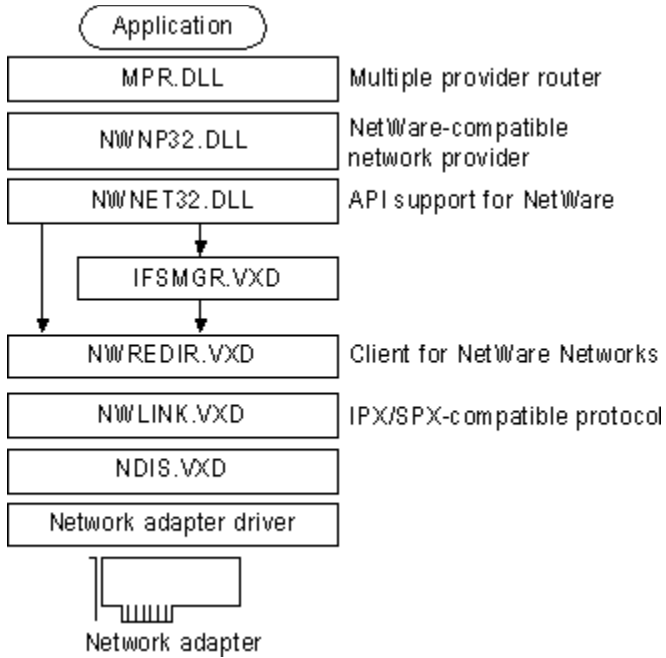

For details about the architecture for Windows 95 with Novell-supplied network clients, see [Windows 95 on NetWare Networks](#).

Windows 95 Network Architecture

Architecture for Clients, Peer Servers, and IPC

Architecture for Peer Resource Sharing

Windows 95 includes components to support file and printer sharing on Microsoft networks and NetWare networks.

When File and Printer Sharing for Microsoft Networks is installed, the Windows 95 SMB server (VSERVER.VXD) is added to the computer's configuration. This component supports all Microsoft networking products that use the SMB file-sharing protocol. The following illustration shows the basic supporting files for File and Printer Sharing for Microsoft Networks in the Windows 95 networking architecture.

Architecture for File and Printer Sharing for Microsoft Networks

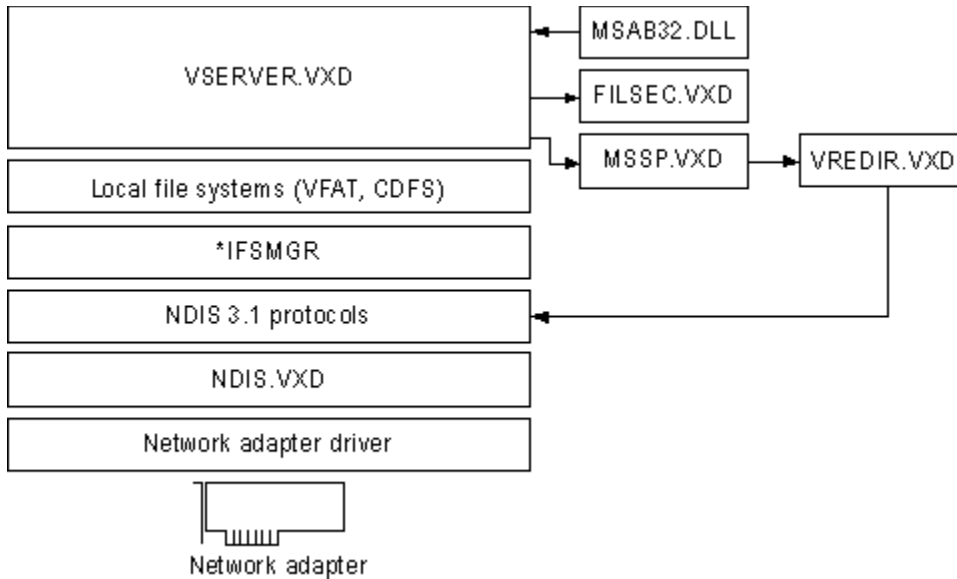

When File and Printer Sharing for NetWare Networks is installed, the Windows 95 NCP server (NWSERVER.VXD) is added to the computer's configuration. Client for NetWare Networks is used to get NetWare server connection information and to enable user-level security based on a NetWare server's user accounts. The following illustration shows the supporting files for File and Printer Sharing for NetWare Networks in the Windows 95 networking architecture.

Architecture for File and Printer Sharing for NetWare Networks

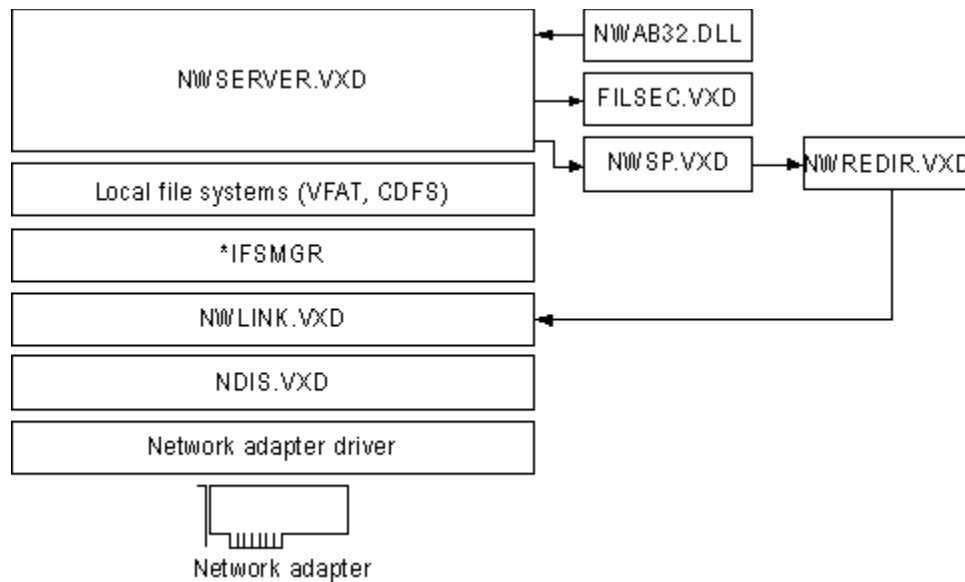

For File and Printer Sharing services with user-level security, the security provider (MSSP.VXD or NWSP.VXD) assists in validating user access when sharing a resource and in retrieving a user list when administrating the server. The network address book (MSAB32.DLL or NWAB32.DLL) translates the account lists from the server and provides the Add Users dialog box for selecting which users get access rights. The file security component (FILESEC.VXD) provides access control based on information in the Registry. Notice that these same security components support features such as remote Registry access even when File and Printer Sharing services are not present.

Windows 95 Network Architecture

Architecture for Clients, Peer Servers, and IPC

IPC and Windows 95

Windows 95 includes several mechanisms that support distributed computing. Typically, distributed computing means that a computing task is divided into two parts. The first part runs on the client computer and requires minimal resources. The other part of the process runs on the server and requires large amounts of data, number crunching, or specialized hardware.

Another type of distributed computing spreads the work among multiple computers. For example, one computer can work on a complex math problem that would take a month to solve. But with distributed computing, 50 computers could work on the same math problem simultaneously and solve it in less than a day.

In both cases, a connection between computers at a process-to-process level allows data to flow in both directions. Windows 95 includes the following interprocess communication (IPC) mechanisms to support distributed computing: Windows Sockets, Remote Procedure Calls (RPC), NetBIOS, named pipes, and mailslots. The following sections provide details about these IPC implementations in Windows 95.

Windows Sockets

Windows Sockets is a Windows implementation of the widely used U.C. Berkeley Sockets API, the *de facto* standard for accessing datagram and session services over TCP/IP. Non-NetBIOS applications must be written to the Sockets interface to access Microsoft TCP/IP protocols. Applications written to the Sockets interface include FTP and SNMP. In Windows 95, sockets support is also extended to IPX/SPX.

Windows Sockets in Windows 95 is a protocol-independent networking API tailored for use by programmers using the Windows family of products. Windows Sockets is a public specification that aims to do the following:

- Provide a familiar networking API to programmers using Windows or UNIX
- Offer binary compatibility between heterogeneous Windows-based TCP/IP stack and utility vendors
- Support both connection-oriented and connectionless protocols

Sockets provide reduced overhead when compared with a NetBIOS protocol. Non-NetBIOS built-in protocols such as TCP/IP and IPX/SPX require a NetBIOS interface and mapping layer. This extra NetBIOS software adds processing time and also adds a header to the data frame sent on the wire. For example, when the NetBIOS interface is used over TCP/IP, a NetBIOS header is added to the frame before the TCP and IP headers. Workstations running only TCP/IP cannot see this frame. However, when sockets are used, the frame is sent using TCP/IP without the addition of a NetBIOS header.

In TCP/IP, the internetwork address is the IP address of the workstation and the software process address is the port number. Source and destination IP address and port numbers are fields in the TCP/IP packet structure. In IPX/SPX, the internetwork address is the combination of the IPX network ID and the media access control (MAC) address of the network adapter, and the software process address is the IPX Socket number. Source network, destination network, node, and socket numbers are fields in the IPX/SPX packet structure.

Note IPX Sockets are not the same as Windows Sockets.

For a bidirectional path, a Windows Sockets application specifies the following, depending on the protocol.

Protocol	Source and destination socket identifiers
----------	---

TCP/IP bidirectional path	IP address and port number of the source
---------------------------	--

IPX/SPX bidirectional path	Network ID, MAC address of the network adapter, IPX socket number
----------------------------	---

The following table describes the supporting files for 16-bit and 32-bit Windows Sockets over TCP/IP and 32-bit Windows Sockets over IPX/SPX.

Windows Sockets Supporting Files

File	Description	Comments
winsock.dll	16-bit Windows Sockets	Provides backward compatibility with existing 16-bit TCP/IP Windows Sockets applications such as ping
wsock.vxd	Virtualized Windows Sockets	Supports 16-bit Windows Sockets and 32-bit TCP/IP and IPX/SPX Windows Sockets
wstcp.vxd	Windows Sockets over TCP/IP ₁	Supports 16-bit Windows Sockets and 32-bit TCP/IP Windows Sockets
wsock32.dll	32-bit Windows Socket	Supports 32-bit TCP/IP Windows Socket applications, such as telnet ,

and 32-bit IPX/SPX Windows Socket applications

wsipx.vxd Windows Sockets over IPX/SPX₂ Supports 32-bit IPX/SPX Windows Sockets

- 1 Windows Sockets over TCP/IP are STREAMS-based over TCP and datagram-based over UDP.
- 2 Windows Sockets over IPX/SPX are STREAMS-based over SPX and datagram-based over IPX.

Popular programs such as **ftp** or **telnet** use Windows Sockets. If you are interested in developing a Windows Sockets 1.1 application, specifications for Windows Sockets are available on the Internet from ftp.microsoft.com, on CompuServe® in the MSL library, and in the *Microsoft Win32 Software Development Kit for Windows 95 and Windows NT*.

RPC

The Microsoft RPC facility is compatible with the Open Software Foundation (OSF) Data Communication Exchange (DCE) specification for remote procedure calls and is completely interoperable with other DCE-based RPC systems such as those for HP and IBM AIX® systems. (The RPC facility is compatible but not *compliant* with the OSF specification — that is, it doesn't start with the OSF source code and build on it.)

RPC uses other IPC mechanisms, such as named pipes, NetBIOS, or Windows Sockets, to establish communications between the client and the server. With the RPC facility, essential program logic and related procedure code can exist on different computers, which is important for distributed applications.

As shown in the following diagram, Windows 95 provides RPC client support over the NetBIOS, named pipes, and Windows Sockets interfaces.

RPC client support in Windows 95

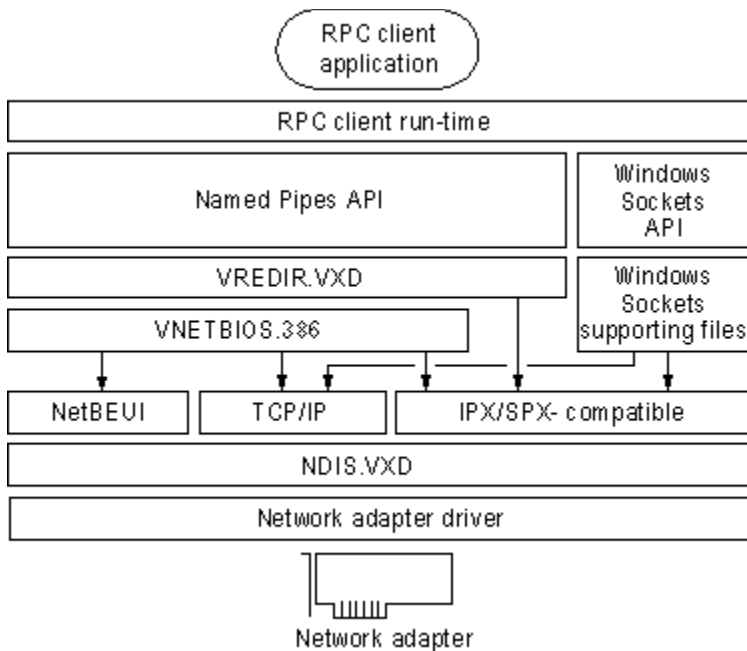

The following diagram shows how Windows 95 provides RPC server support over NetBIOS and Windows Sockets. There is no server support for RPC over named pipes. With a named-pipes RPC application, the named-pipes client can be run on the computer running Windows 95 but the named-pipes server must be set up on a LAN Manager server or Windows NT computer.

RPC server support in Windows 95

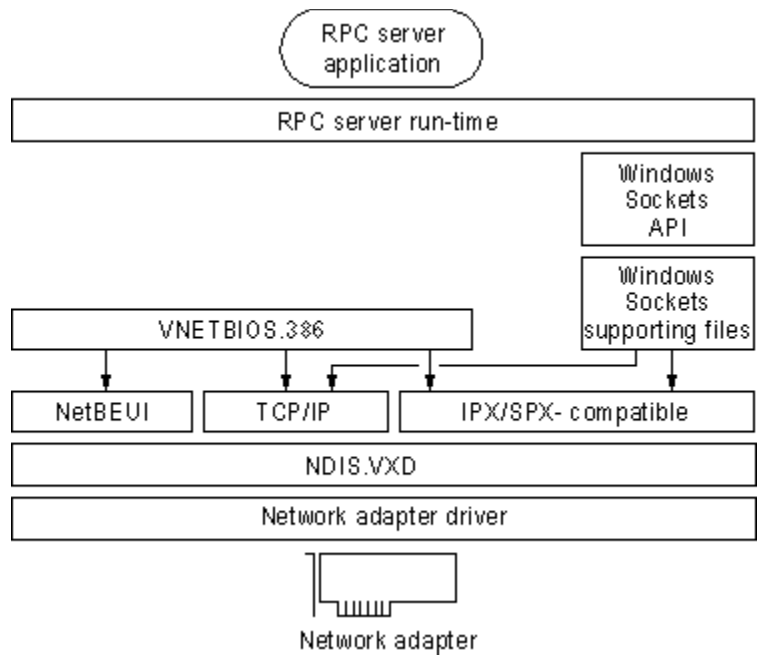

NetBIOS

NetBIOS can be used in Windows 95 for communication between protocols and upper-level software such as the redirector and server service. NetBIOS provides backward compatibility for existing NetBIOS applications. NetBIOS provides a protocol-independent way of creating sessions and datagrams, and supporting name resolution over multiple protocols. NetBIOS is supported by the Microsoft TCP/IP, NetBEUI, and IPX/SPX-compatible protocols in Windows 95. The additional NetBIOS driver and DLL enable Windows 95 to be compatible with NetBIOS applications and to run software that specifically requires NetBIOS. The NetBIOS software is used only for these situations.

NetBIOS defines the interface between the redirector and the protocol layers. The NetBIOS interface is a set of function calls that allow an application (such as the redirector in the Windows 95 protected-mode network client) to use the services of a Transport-layer service provider such as the NetBEUI protocol driver.

Many network applications use NetBIOS to send commands to the protocol driver. As long as a protocol driver recognizes NetBIOS commands issued by an application, that protocol driver can be used with any NetBIOS application. The NetBIOS interface in Windows 95 (NETBIOS.DLL and VNETBIOS.386) is supported by all three protocols provided with Windows 95.

The architecture for NetBIOS over the various protocols is described with the respective protocols earlier in this chapter.

Client-Side Named Pipes

Named pipes provides backward compatibility with existing LAN Manager installations and applications. Windows 95 supports client-side named pipes for Microsoft networks. Server-side named pipes are not supported.

Client for Microsoft Networks makes the Named Pipes API available for applications that use named pipes for IPC. However, Client for Microsoft Networks does not provide named pipes support for other networks such as Novell NetWare and Banyan VINES. A user who needs Novell NetWare or Banyan VINES named-pipes support must use the real-mode TSRs and network components provided by Novell or Banyan.

Named pipes provide an easy-to-access conduit for a one-to-one, reliable, connection-oriented data transfer between two processes. These two processes are normally differentiated as a client process and a server process. The term "server" as applied to the server process in a named-pipe application does not refer to the "server service" that is a component of the network operating system, although the server service may be (but is not necessarily) involved in making the pipe available to other workstations.

- The named-pipe server process creates the pipe and manages access to it. The resources that make up the pipe are owned by the server process and physically exist on the workstation where the server process is running.
- The named-pipe client process uses the services of the underlying network protocols to access the remote pipe resources.

Although named pipes are usually used bidirectionally, the pipe can be configured to allow communication in only one direction, such as from server to client.

A common use for named pipes is in client-server applications based on SQL. The SQL client application can be run on a computer running Client for Microsoft Networks. The Microsoft SQL Server application, however, must be set up on a LAN Manager, Windows NT, or other named-pipes server.

Mailslots

Mailslots provide backward compatibility with existing LAN Manager installations and applications. Mailslot APIs in Windows 95 and Windows NT are a subset of the APIs in Microsoft OS/2 LAN Manager. Client for Microsoft Networks makes the Mailslots API available for applications that use mailslots for interprocess communication.

Mailslots can be used for one-to-one or one-to-many communication. A mailslot can be created on any network workstation. When a message is sent to a mailslot, the sending application specifies in the mailslot message structure whether the message is to be sent using first-class or second-class delivery.

First-class delivery is a session-oriented, guaranteed data transfer for one-to-one or one-to-many communication. Messages designated as first-class delivery can only be sent to a mailslot that was created on a server. (Notice that Windows 95 does not use first-class messaging.)

Second-class delivery is a datagram-based, unguaranteed data transfer for one-to-one and many-to-one communication. Messages designated as second-class delivery can be sent to a mailslot that was created on any workstation, or even on multiple workstations, if the message size is 400 bytes or less.

Windows 95 and Windows NT implement only second-class mailslots, which are most useful for identifying other computers or services on a network and for wide-scale identification of a service. Windows 95 uses second-class mailslots for WinPopup messages and browsing.

Introduction

This chapter presents background information about the structure of the Registry, and how values from Windows 3.x INI files are stored in the Registry. Notice, however, that no descriptions of individual Registry entries are provided, because such details are beyond the scope of the *Windows 95 Resource Kit*.

Caution Wherever possible, use Control Panel or System Policy Editor to ensure values are stored properly in the Registry when changing the configuration. If you use Registry Editor to change values, you will not be warned if any entry is incorrect.

- [Windows 95 Registry Overview](#)
- [Getting Started with Registry Editor](#)
- [How Windows 95 Components Use the Registry](#)
- [Registry Structure](#)
 - [Registry Hierarchy](#)
 - [Value Entries in the Registry Keys](#)
 - [Registry Files](#)
 - [Recovering Registry Data](#)
 - [Saving and Restoring the Registry](#)
- [Hkey_Local_Machine](#)
 - [Introduction: Hkey_Local_Machine](#)
 - [Config Subtree in Hkey_Local_Machine](#)
 - [Enum Subtree in Hkey_Local_Machine](#)
 - [Software Subtree in Hkey_Local_Machine](#)
 - [System Subtree in Hkey_Local_Machine](#)
- [Hkey_Current_User and Hkey_Users](#)
- [Hkey_Current_Config and Hkey_Dyn_Data](#)
- [Initialization Files and the Registry](#)
 - [WIN.INI Settings in the Registry](#)
 - [SYSTEM.INI Settings in the Registry](#)

Windows 95 Registry Overview

The Windows 95 Registry provides a unified database for storing system and application configuration data in a hierarchical form. Because the Registry contains all settings required to configure memory, hardware peripherals, and Windows 95-supplied network components, you may find that it is no longer necessary to configure settings in startup configuration and initialization files. Also, because settings are stored in a central location, you can provide both local and remote support for system configuration using Windows 95 tools.

The Registry is roughly analogous to the INI files used under Windows 3.x, with each key in the Registry similar to a bracketed heading in an INI file and with Registry values similar to entries under the INI headings. However, Registry keys can contain subkeys, while INI files do not support nested headings. Registry values can also consist of binary data, rather than the simple strings used in INI files.

Although Microsoft discourages using INI files in favor of Registry entries, some applications (particularly 16-bit Windows-based applications) still use INI files. Windows 95 supports INI files solely for compatibility with those applications and related tools (such as setup programs). The AUTOEXEC.BAT and CONFIG.SYS files also still exist for compatibility with real-mode system components and to allow users to change certain default system settings such as the PATH environment variable. New Win32-based applications can store their initialization information in the Registry.

The Registry provides the following benefits in Windows 95:

- A single source provides data for enumerating and configuring the hardware, applications, device drivers, and operating system control parameters. The configuration information can be recovered easily in the event of system failure.
- Users and administrators can configure computer options by using standard Control Panel tools and other administrative tools, reducing the likelihood of syntactic errors in configuration information.
- A set of network-independent functions can be used to set and query configuration information, allowing system administrators to examine configuration data on remote networked computers.
- The operating system automatically backs up the last good configuration used to start the computer.

Because user-specific Registry information can be maintained on a central network server when user profiles are enabled, users can have access to personal desktop and network access preferences when logging on to any computer, and settings for multiple users can be maintained on a single computer. Also, system policies can be used to enforce certain Registry settings for individuals, workgroups, or all users. For more information, see [User Profiles and System Policies](#).

Getting Started with Registry Editor

To get the most out of the material in this chapter, you will want to run Registry Editor while you are reading so that you can see the contents of the Registry on your computer. By default, Registry Editor does not appear in any menu or on the desktop. Notice, also, that Registry Editor (REGEDIT.EXE) is copied to the Windows directory automatically when Windows 95 is installed from a compact disc. Registry Editor is not available with the Windows 95 floppy disks.

Tip You can add the Registry Editor icon to your desktop by using the right mouse button to drag REGEDIT.EXE from Windows Explorer to the desktop.



To run Registry Editor

- From the Start menu, click Run and type **regedit**



To find specific data in the Registry

- In the Registry Editor window, double-click any folder icon for a Registry key to display the contents of that key.

-Or -

From the Edit menu, click Find. Then type all or part of the text string you want to find, and click options to specify whether you want to find a key name, an entry name, or data.

After Registry Editor finds the first instance of the text string, you can press F3 to search for the next instance.

Registry Editor can be used to view or modify a Registry on a local computer or on another computer over a network. Both the administrator's computer and the remote computer require the Microsoft Remote Registry service to allow remote Registry access. For more information about installing and taking advantage of the Microsoft Remote Registry service, see [Remote Administration](#).

Tip for Disabling Direct Editing of the Registry

The network administrator can restrict users from being able to use Registry Editor to modify the Registry by setting a system policy named Disable Registry Editing Tools. Notice, however, that this policy does not prevent the administrator or another user from modifying the Registry by using System Policy Editor. For more information about this restriction and about using System Policy Editor to modify the Registry on individual or multiple computers, see [User Profiles and System Policies](#).

How Windows 95 Components Use the Registry

With Windows 95, the operating system stores and checks the configuration information in the Registry for most configuration settings during system startup. The following figure provides an overview of how various Windows 95 components and applications use the Registry.

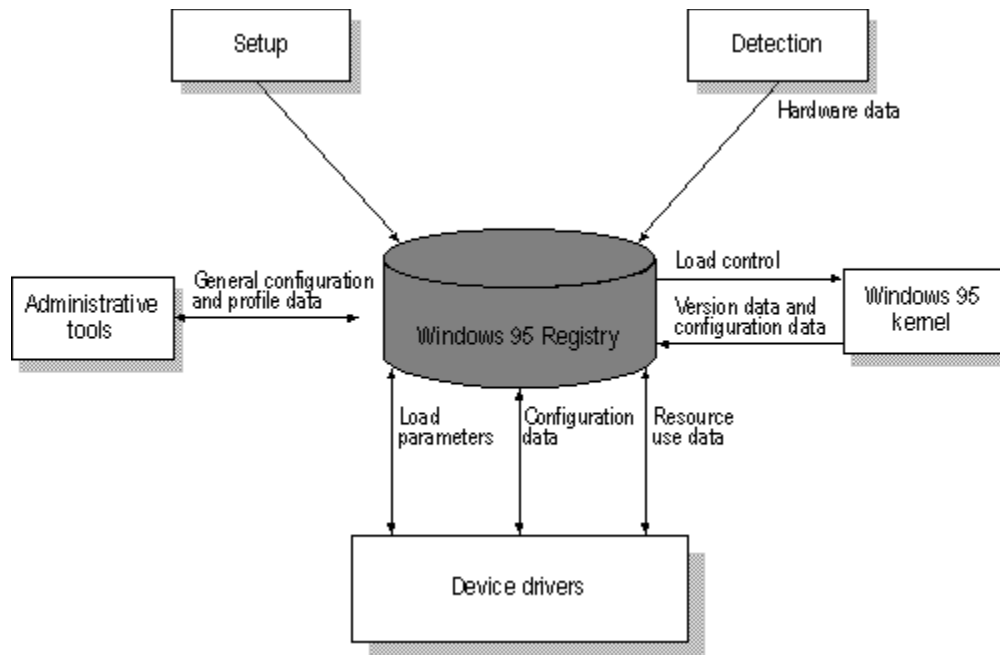

- Whenever you run Windows 95 Setup, use the Add New Hardware option in Control Panel, or run other setup programs for hardware, the Windows 95 Configuration Manager places hardware configuration data in the Registry. This information includes a list of hardware detected in the computer.
- When you install Windows 95 in the same directory as an earlier version of Windows, your previous desktop settings are moved from INI files to the Registry. When you make changes to the desktop configuration, the settings are added to the Registry.
- Each time you add or remove a Plug and Play-compliant device on a computer running Windows 95, configuration data is added to the Registry. For example, new information is added when you install a PCMCIA modem.
- Device drivers send and receive load parameters and configuration data from the Registry. This data is similar to settings defined under MS-DOS by **device=** lines in CONFIG.SYS.
- System policies, user profiles, and administrative tools such as the Windows 95 Control Panel can be used to add or modify configuration data. Registry Editor can be used to view and occasionally change the system configuration.

A set of Registry APIs can make information available through remote procedure calls (RPC) to Windows 95 management tools from other vendors. This permits administrators to view and modify configuration information remotely for hardware and software components that store information in the Registry. Notice that the Registry APIs are accessible remotely using named pipes (client-side only), NetBIOS over NetBEUI, Windows Sockets on IPX, and Windows Sockets on IP.

Registry Structure

Registry Editor displays the contents of the Registry database in six subtrees. The hierarchical structure that appears in Registry Editor is similar to how Windows Explorer displays hierarchical directory structures.

This section describes the hierarchical organization of the Registry and defines the overall structure of keys and value entries. The actual contents or location of a specific Registry subkey may differ from what is described here, depending on the services and software are installed. However, this description of the general organization will help you understand how to navigate the Registry.

Registry Hierarchy

The Windows 95 Registry structure represents database information specific to the computer and to individual users. The computer-specific information includes setting for hardware and software installed on the computer. The user-specific information includes settings in user profiles, such as desktop settings, preferences for certain software, and personal printer and network settings.

In the Registry, each individual key can contain data items called value entries and can also contain additional subkeys, with keys roughly analogous to directories, and value entries analogous to files. Each of the root key names begins with “Hkey_” to indicate to software developers that the key is a unique identifier, called a handle, that can be used by a program to access resources.

The following briefly describes the Registry subtrees. More details are provided in this chapter.

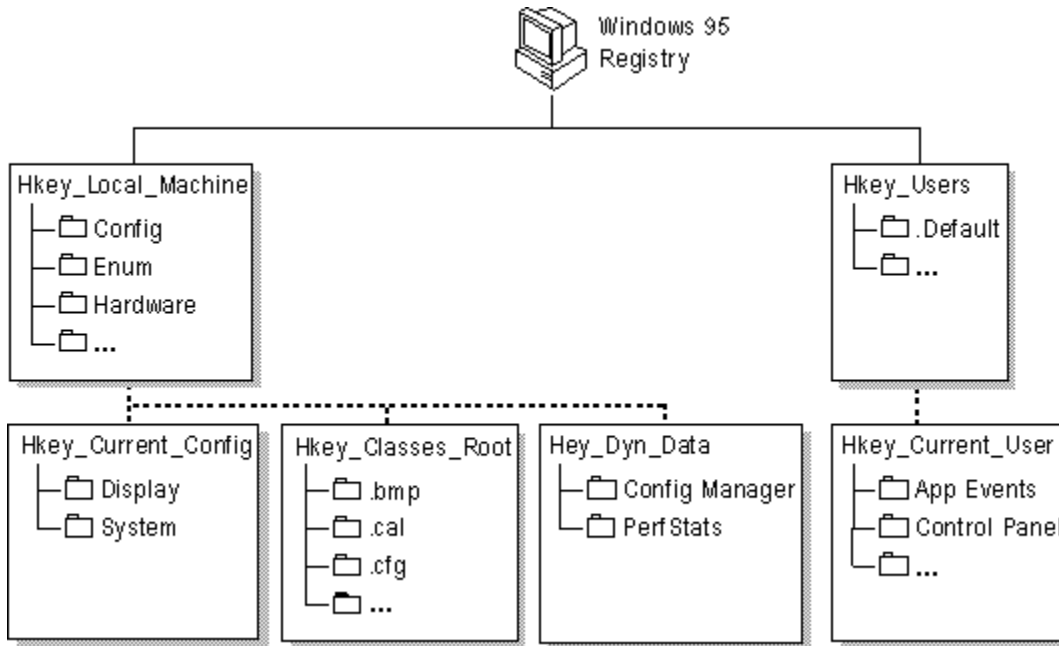

Hkey_Local_Machine.

This key contains computer-specific information about the type of hardware installed, software settings, and other information. This information is used for all users who log on to this computer.

Hkey_Current_Config.

This key points to a branch of Hkey_Local_Machine\Config that contains information about the current configuration of hardware attached to the computer.

Hkey_Dyn_Data.

This key points to a branch of Hkey_Local_Machine that contains the dynamic status information for various devices as part of the Plug and Play information. This information may change as devices are added to or removed from the computer. The information for each device includes the related hardware key and the device's current status, including problems.

Hkey_Classes_Root.

This key points to a branch of Hkey_Local_Machine that describes certain software settings. This key displays the same data as it did in Windows 3.1 — essential information about OLE and association mappings to support drag-and-drop operations, Windows 95 shortcuts (which are, in fact, OLE links), and core aspects of the Windows 95 user interface.

Hkey_Users.

This key contains information about all the users who log on to the computer, including both generic

and user-specific information. The generic settings are available to all users who log on to the computer. The information is made up of default settings for applications, desktop configurations, and so on. This key contains subkeys for each user that logs on to this computer.

Hkey_Current_User.

This key points to a branch of Hkey_Users for the user who is currently logged on.

Value Entries in the Registry Keys

Registry Editor displays data in two panes. The value entries in the right pane are associated with the selected key in the left pane.

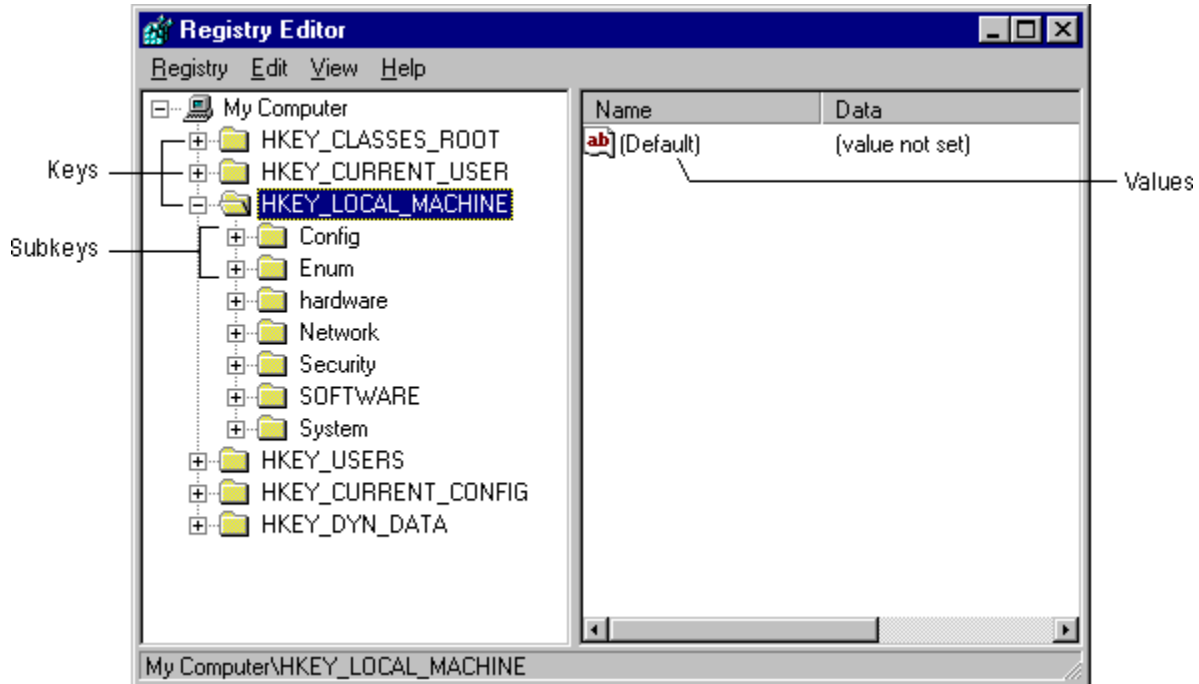

A value entry has three parts: the data type of the value (which appears as an icon), the name of the value, and the value itself. A value entry cannot be larger than about 64K. The limit to total Registry size depends on available hard disk space.

The following table lists the data types currently used by the system.

Data type	Description
<input type="checkbox"/>	Binary data. Most hardware component information is stored as binary data, and can be displayed in Registry Editor in binary or hexadecimal format. For example, Int 13: 01.
<input type="checkbox"/>	A sequence of characters representing human-readable text. For example, BitsPerPixel: "8".

Registry Files

The Registry is logically one data store, but physically it consists of two different files to allow maximum flexibility for network configurations:

- User-specific information is contained in USER.DAT. The information in this file is reflected in user profiles.
- Hardware-specific and computer-specific settings are contained in SYSTEM.DAT. This information is reflected in hardware profiles and in the settings displayed in Device Manager.

By default, USER.DAT and SYSTEM.DAT are stored in the Windows SYSTEM subdirectory, but these two files can be located in physically different locations. For example, if user profiles are enabled, SYSTEM.DAT can be stored on the local hard disk and USER.DAT stored in each user's logon

directory on the network, allowing “roving” users to maintain the same desktop preferences wherever they log on to the network. For shared installations, these files are stored in the machine directory.

For information about how Windows 95 chooses between local and network versions of USER.DAT when loading a user profile, and how system policies can override settings in .DAT files to enforce user-specific and computer-specific information, see [User Profiles and System Policies](#).

Windows 95 Registry

Registry Structure

Recovering Registry Data

In Windows 95, data is written to the Registry only when a *flush* occurs — that is, when something happens after changed data has aged more than a few seconds or when an application intentionally flushes the data to the hard disk.

Each time Windows 95 successfully starts, the operating system backs up the Registry by copying the current SYSTEM.DAT and USER.DAT files to SYSTEM.DA0 and USER.DA0, respectively. If Windows 95 fails to start, the backed-up Registry from the last successful startup can be copied over the current Registry. This method recovers the last successful settings after a system failure.

Saving and Restoring the Registry

The Registry can be exported, imported, or recreated using either the Windows-based version of Registry Editor or the real-mode version on the Windows 95 emergency startup disk. By using the export capabilities of Registry Editor, a specific branch or the entire Registry can be saved in text format as a .REG file. A branch of or the entire Registry can be restored by importing a .REG file that was created by exporting the Registry.

If you are exporting or importing Registry files using the Windows-based version of Registry Editor, use the Export and Import commands from the Registry menu. The information in online Help can guide you through this process.

In rare circumstances when the Registry is badly corrupted, you can start the computer using the Windows 95 startup disk. Then you can use the real-mode REGEDIT.EXE utility on the startup disk to import a .REG file. In this case, the following command syntax can be used at the command prompt.

regedit [/L:*system*] [/R:*user*] *file1.reg, file1a.reg...*

regedit [/L:*system*] [/R:*user*] /e *file3.reg* [*regkey*]

regedit [/L:*system*] [/R:*user*] /c *file2.reg*

Parameter	Description
-----------	-------------

/L: <i>system</i>	Specifies the location of SYSTEM.DAT.
-------------------	---------------------------------------

/R: <i>user</i>	Specifies the location of USER.DAT.
-----------------	-------------------------------------

<i>file1.reg</i>	Specifies one or more .REG files to import into the Registry.
------------------	---

/e <i>file3.reg</i>	Specifies the filename to which the Registry should be exported.
---------------------	--

<i>regkey</i>	Optionally, specifies the starting Registry key from which to export a portion of the Registry. If no value is specified, regedit /e exports the entire Registry.
---------------	--

/c <i>file2.reg</i>	Specifies the .REG file to use to replace the entire contents of the Registry.
---------------------	--

Caution Use the **regedit /c** option with extreme care, and only when you are sure that the specified .REG file contains a complete image of the Registry.

Also, the *Windows 95 Resource Kit* does not provide sufficient information to guide you through the process of editing an .REG file, so it is recommended that you undertake editing an .REG file only under the guidance of your product support representative.

Hkey_Local_Machine

Hkey_Local_Machine contains the configuration data for the local computer. The information in this database is used by applications, device drivers, and Windows 95 to determine configuration data for the local computer, regardless of which user is logged on and what software is in use.

Hardware devices can place information in the Registry automatically using the Plug and Play interface. Software for installing device drivers can place information in the Registry by writing to standard APIs. Users can place information about hardware in the Registry by using the Add New Hardware option and other options in Control Panel, or by using Device Manager, as described in [Devices](#).

Hkey_Local_Machine contains several subkeys, as listed briefly in the following table. The rest of this section provides details about some of these keys.

Subkey name	Contents
Config	A collection of configurations for the local computer
Enum	Information about hardware devices on the system
Hardware	Information about serial ports and modems used with the HyperTerminal program
Network	Network information created when a user logs on to a networked computer, including the user name, primary network provider, whether the logon was validated by a server, and information about the system policies processor
Security	Information about the network security provider and remote administration capabilities
Software	The computer-specific information about software installed on the local computer, along with miscellaneous configuration data
System	The database that controls system startup, device driver loading, Windows 95 services, and operating system behavior

Config Subtree in Hkey_Local_Machine

The Hkey_Local_Machine\Config subtree contains information about alternate hardware configurations for the computer. For example, it can contain information about multiple configurations to be used when the computer is connected to a network, when it is undocked from a docking station, and so on. Each alternate configuration is assigned a unique identifier, and this configuration ID has a subkey under the Config key. Each configuration appears in the list of hardware profiles in the System option in Control Panel.

When Windows 95 checks the hardware configuration at system startup, one of three things occurs:

- In most situations, the configuration ID is mapped to a unique configuration and Windows 95 selects the appropriate one automatically, and the settings for the related Config subkey are used for system configuration.
- If the user is starting the computer for the first time with new hardware components, Windows 95 creates a new configuration for the new configuration ID, and a new Config subkey is added to the Registry.
- If the configuration ID is mapped to more than one configuration (for example, because Windows 95 cannot distinguish between two configurations), the user is prompted to choose which configuration to use.

Windows 95 Registry
Hkey_Local_Machine

Enum Subtree in Hkey_Local_Machine

Windows 95 bus enumerators are responsible for building the hardware tree. This includes assigning an identification code to each device on its bus and retrieving the device's configuration information, either directly from the device or from the Registry. For more information about the hardware tree and bus enumerators, see [Introduction to System Configuration](#), and [Windows 95 Architecture](#).

Bus enumeration information is stored in the Hkey_Local_Machine\Enum subtree. For all types of devices, subkeys contain information such as device type, assigned drive letter, hardware ID, and device manufacturer, plus driver-related information for network components.

The following table shows which devices are enumerated in typical subkeys.

Subkey	Device enumeration
ESDI	Fixed disk devices
FLOP	Floppy disk devices
ISAPNP	Plug and Play devices on an ISA bus
Monitor	Monitor devices
Network	Network protocol, server, and bindings
Root	Legacy devices

Windows 95 Registry
Hkey_Local_Machine

Software Subtree in Hkey_Local_Machine

The Hkey_Local_Machine\Software subtree contains configuration information about all installed software that can write information in the Registry. The entries in this key apply for anyone using this particular computer, and include definitions for file associations and OLE information.

The software subkey contains, for example, the information you add when registering an application to use a specific filename extension and information added during installation of Windows-based applications.

The Hkey_Local_Machine\Software subtree contains several subkeys, including the Classes subkey, plus *description* subkeys for all installed software that can write to the Registry, as described in the following sections.

Windows 95 Registry

Hkey_Local_Machine

Software Subtree in Hkey_Local_Machine

Classes Subkey

The Hkey_Local_Machine\Software\Classes subkey defines types of documents and provides information about OLE and filename-extension associations that can be used by applications. Hkey_Classes_Root is an alias for this subkey.

Hkey_Classes_Root merely points to Hkey_Local_Machine\Software\Classes. The sole purpose for Hkey_Classes_Root is to provide compatibility with the Windows 3.x registration database.

The Classes subkey contains two types of subkeys:

- Filename-extension subkeys, which specify the class-definition associated with files that have the selected extension.
- Class-definition keys, which specify the shell and OLE properties of a class (or type) of document. If an application supports Dynamic Data Exchange (DDE), the Shell subkey can contain Open and Print subkeys that define DDE commands for opening and printing files, similar to the OLE and DDE information stored in the Registry under earlier versions of Windows. In the following illustration, `c:\windows\notepad.exe %1` is the open command, and the `%1` parameter stands for the selected filename in Windows Explorer when the command is carried out.

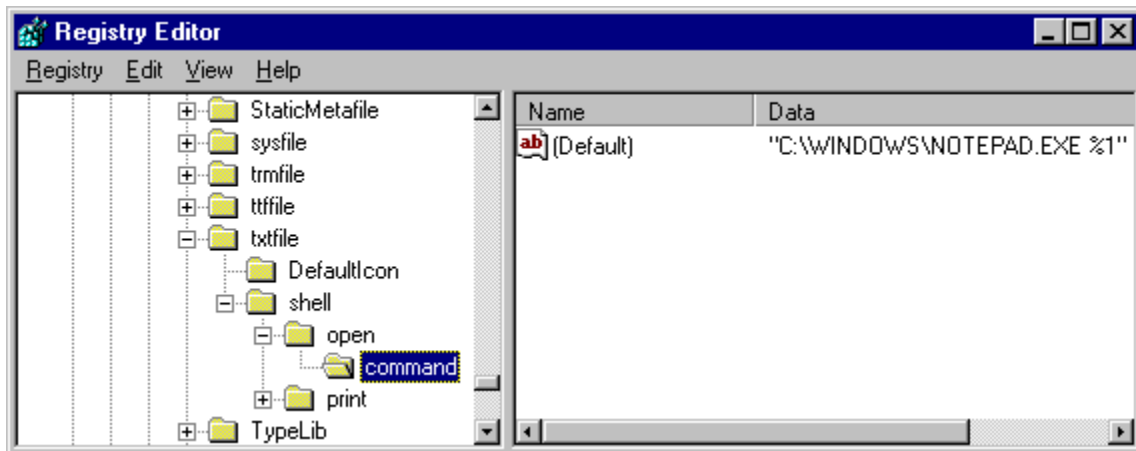

Windows 95 Registry
Hkey_Local_Machine
Software Subtree in Hkey_Local_Machine

Description Subkeys

The various Hkey_Local_Machine\Software\Description subkeys contain the names and version numbers of the software installed on the local computer (if that software writes information to the Registry as part of its installation process). User-specific information about the configuration of an application is stored at the same relative path under Hkey_Current_User.

Important The information in each subkey is added by the related application. Do not edit entries in these subkeys unless directed to do so by your application vendor.

During installation, applications record this information in the following form:

Hkey_Local_Machine\Software\CompanyName\ProductName\Version

The key named Hkey_Local_Machine\Software\Microsoft and its subkey named Windows\CurrentVersion are of particular interest. These subkeys contain information about software that supports services built into Windows 95.

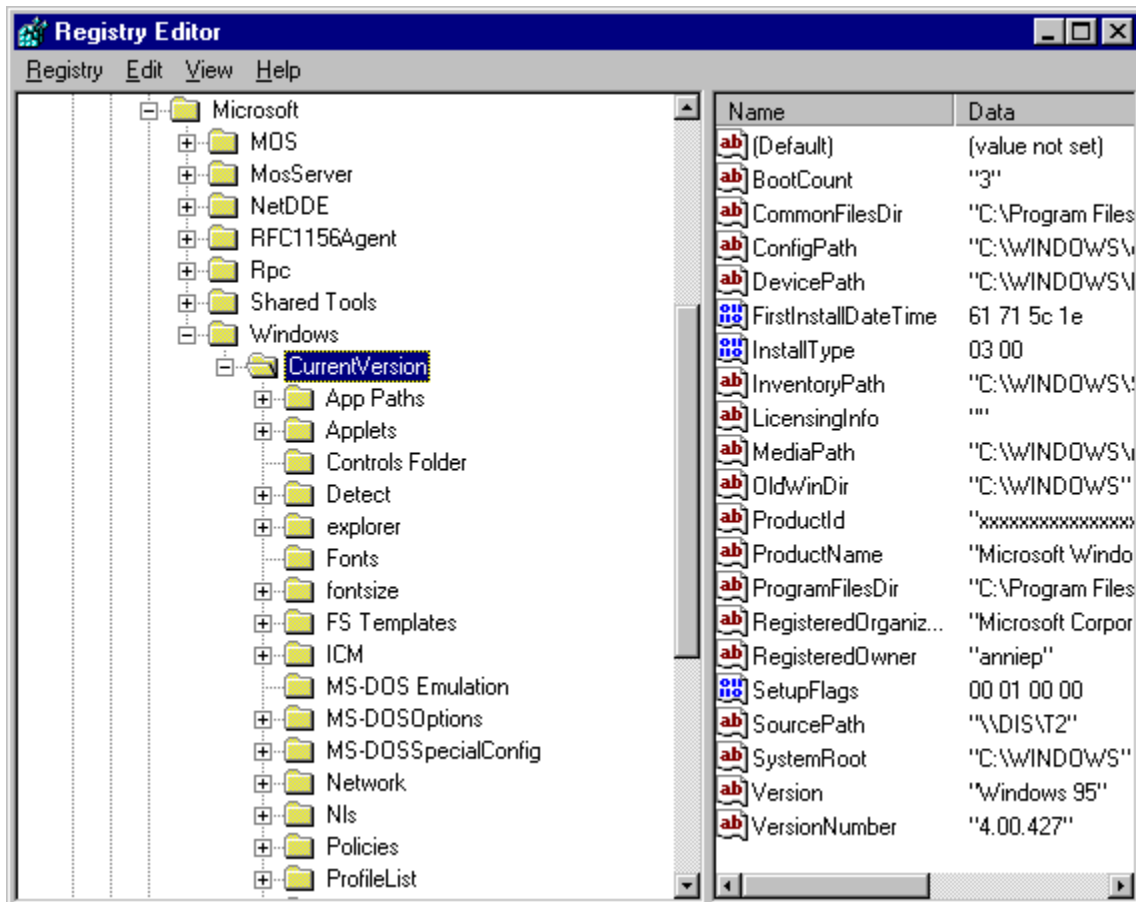

The Setup subkey under Hkey_Local_Machine\Software\Microsoft\Windows \CurrentVersion is used internally by Windows 95 for its Setup program.

Windows 95 Registry
Hkey_Local_Machine

System Subtree in Hkey_Local_Machine

The data in Hkey_Local_Machine\System is organized into control sets that contain a complete set of parameters for device drivers and services that can be loaded with Windows 95.

All data that controls startup is described in the CurrentControlSet subtree under Hkey_Local_Machine\System. This control set has two parts:

- The Control key contains information used to control system startup, including the computer's network name and the subsystems to start.
- The Services key contains information to control the loading and configuration of drivers, file systems, and so on. The data in the Services key also controls how these services call each other.

Windows 95 Registry
Hkey_Local_Machine
System Subtree in Hkey_Local_Machine

Control Subkey

The Control subkey contains startup parameters for the system, including settings for startup and shutdown, file system performance, keyboard layouts and language support, and so on. The following table describes some typical subkeys.

Subkey	Contents
ComputerName	The computer name, which should be set using the Network option in Control Panel
FileSystem	The type and settings of the file system
IDConfigDB	The identification for the current configuration
Keyboard layouts	A list of the DLLs for the keyboard language, which should be set using the Keyboard option in Control Panel
Resources	Descriptions and driver information for multimedia components
NetworkProvider	Descriptions of the network providers
Nls	Information on national language support, including language and locale preferences, which should be set using the Keyboard option in Control Panel
PerfStats	Statistics gathered from system components that can be viewed using System Monitor
Print	Information about the current printers and printing environment, contained in several subkeys: <ul style="list-style-type: none">• Environments, which contains subkeys defining drivers and print processors for operating system environments• Monitors, which can contain subkeys with data for specific network printing monitors• Printers, which can contain subkeys describing printer parameters for each installed printer• Providers, which can contain subkeys describing DLLs for network print services
Session Manager	Global variables that are maintained by the operating system, plus subkeys that list applications that do not run well under Windows 95, DLLs whose version numbers should be checked, and directories and filenames for all the Session Manager DLLs
TimeZoneInformation	Values for time zone settings, which should be set using the Date/Time option in Control Panel
Update	Value indicating whether Windows 95 was installed over an earlier version of Windows
VMM32	The filenames of VxD files combined into the VMM32.VXD virtual device driver

Windows 95 Registry
Hkey_Local_Machine
System Subtree in Hkey_Local_Machine

Services Subkey for CurrentControlSet

The Services subkey in CurrentControlSet lists the Kernel device drivers, file system drivers, and Windows 95 service drivers that can be loaded at startup. The Services subkey also contains subkeys with static descriptions of hardware to which drivers can be attached. The following table shows some typical Services subkeys.

Subkey	Contents
<i>Agent_name</i>	Subkeys for each installed system agent, such as Microsoft Network Monitor, SNMP, or network backup agents
Arbitrators	Subkeys for arbitrators required to manage resources between competing devices, usually including address, DMA, I/O, and IRQ arbitrators
Class	Subkeys for all classes of devices the operating system supports, such as disk drives, keyboard, display, mouse, and so on
MSNP32, NWNP32	Subkeys for 32-bit, protected-mode network providers, including logon and security provider information
VxD	Subkeys for all virtual device drivers, including disk drivers, network components, disk caches, and so on

Caution Do not change these value entries using Registry Editor. These settings should be maintained only by the system. Settings for drivers that appear under the Services subkeys can be changed by using Control Panel or system policies.

Hkey_Current_User and Hkey_Users

Hkey_Users contains the .Default subkey plus all previously loaded user profiles for users who have logged on. The information in the .Default subkey is used to create the user profile for a user who logs on without a personal user profile. The .Default subkey contains keys for AppEvents, Control Panel, Keyboard layouts, Network, RunMRU, and Software, among others.

Hkey_Current_User contains the database with the user profile of the user who is currently logged on. A user profile ensures that the user interface and operation of Windows 95 will be the same on any computer where that user logs on, if that person's profile is available at that computer.

Hkey_Current_User contains all the information necessary to set up a particular user environment on the computer, such as application preferences, screen colors, and security access permissions. Many of these settings are the same kind of information that was stored in WIN.INI under Windows 3.x. Hkey_Current_User includes several subkeys, some of which are described in the following table.

Subkey	Contents
AppEvents	Subkeys containing the path and filename of the system sound file that plays when specific system events occur
Control Panel	Subkeys containing Control Panel settings, including information stored in WIN.INI and CONTROL.INI under Windows 3.x
Keyboard layouts	A value entry defining the current active keyboard layout, which should be set by using the Keyboard option in Control Panel
Network	Subkeys describing persistent and recent network connections
RunMRU	Subkeys listing the most recently used applications
Software	Subkeys describing the current user's software settings, using the same structure as Hkey_Local_Machine\Software and containing application-specific information stored in WIN.INI or private initialization files under Windows 3.x
StreamMRU	Subkeys for the most recently used documents

Whenever similar data exists in Hkey_Local_Machine and Hkey_Current_User, the data in Hkey_Current_User takes precedence. For example, settings for applications and the desktop defined by the current user take precedence over default settings.

Windows 95 Registry

Hkey_Current_Config and Hkey_Dyn_Data

The Hkey_Current_Config key points to the current system configuration in the collection of configurations stored in Hkey_Local_Machine\Config.

Some information in Windows 95 must be stored in RAM because it requires fast modification and retrieval that cannot wait for the Registry to flush to the hard disk. All this data can be found under Hkey_Dyn_Data.

The Hkey_Dyn_Data\Configuration Manager subkey, sometimes referred to as the hardware tree, is a record in RAM of the current system configuration. The information is drawn from the devices currently installed and loaded, or that failed loading. The hardware tree is created every time the system starts and updates whenever a change occurs to the system configuration. The information that appears in Registry Editor is provided when this key is displayed, so it is never out of date.

Hkey_Dyn_Data also contains statistics gathered for various network components in the system. These reside under Hkey_Dyn_Data\PerfStats.

VxDs from other vendors can provide dynamic data to this area too. For more information, see the *Win32 Software Development Kit for Windows 95 and Windows NT*.

Initialization Files and the Registry

Although the Registry replaces the basic function of the initialization files used in earlier versions of Windows, the SYSTEM.INI, WIN.INI, and WINFILE.INI files still appear in the Windows directory. These files continue to be used for compatibility with earlier Windows-based applications and device drivers. For example, entries in WIN.INI and SYSTEM.INI created by Win16-based applications are not updated in the Registry, because such applications do not know how to access the Windows 95 Registry.

If you install Windows 95 as an upgrade over Windows 3.1, some INI file settings are copied into the Registry, including settings from CONTROL.INI, PROGMAN.INI, SYSTEM.INI, and WIN.INI.

Some INI file entries are not moved to the Registry, but remain in the INI file for compatibility with Win16-based applications. Most of these entries can be changed without editing the INI files by using the graphical tools provided with Windows 95. However, some INI entries cannot be set using the Windows 95 user interface. These entries are required for some applications to function properly, but shouldn't need direct modification by users.

Windows 95 Registry

Initialization Files and the Registry

WIN.INI Settings in the Registry

Windows 95 migrates settings from configuration files into the Registry during Setup. The following table shows where WIN.INI entries migrated to the Registry. For information about specific WIN.INI entries moved during Windows 95 installation, see [Setup Technical Discussion](#).

Registry Paths for Migrated WIN.INI Sections

WIN.INI section **Subkey in Hkey_Current_User**

[desktop]	\Control Panel\Desktop
[Windows]	\Control Panel\Desktop
[sounds]	\AppEvents\Schemes\Apps\event\current

The following tables list entries retained in WIN.INI for compatibility with applications written for earlier versions of Windows. These values can be set using Control Panel and other tools in the Windows 95 interface.

Entries in WIN.INI Retained and Supported in the User Interface

[Windows]:

CursorBlinkRate	DoubleClickSpeed	MouseSpeed
Device	KeyboardDelay	MouseTrails
DoubleClickHeight	KeyboardSpeed	SwapMouseButtons
DoubleClickWidth		

[Intl]:

iCountry	iNegCurr	sLanguage
iCurrDigits	iTime	sDecimal
iCurrency	iTLZero	sList
iDate	s1159	sShortDate
iDigits	s2359	sLongDate
iLZero	sCountry	sThousand
iMeasure	sCurrency	sTime

[fonts]: *font-name*

[ports]: *portname*

[PrinterPorts]: *device*

Entries in WIN.INI Retained but Not Supported in the User Interface

[embedding]: *object*

[FontSubstitute]: *font-name=font-name*

[Mail]: MAPI

[mci extensions]: *extension*

[Windows]: Load and Run

Windows 95 Registry

Initialization Files and the Registry

SYSTEM.INI Settings in the Registry

The following table lists SYSTEM.INI entries that are migrated to the Registry when Windows 95 is installed in the same directory as a previous version of Windows 3.x. For information about specific SYSTEM.INI entries related to loading VxDs and configuring network components, see [Setup Technical Discussion](#).

Registry Paths for Migrated SYSTEM.INI Entries

SYSTEM.INI **Subkey in Hkey_Local_Machine**
entry

[386Enh]:

Network System\CurrentControlSet\Services\VxD\Vnetsetup
 Transport Software\CurrentControlSet\Services\VxD*transport entry*

[network]:

Comment System\CurrentControlSet\Services\VxD\Vnetsetup
 ComputerName System\CurrentControlSet\Control\ComputerName
 EnableSharing System\CurrentControlSet\Services\VxD\Vnetsetup
 LMAnnounce System\CurrentControlSet\Services\VxD\Vnetsetup
 LogonDomain Network
 LogonValidated Network
 MaintainServerList System\CurrentControlSet\Services\VxD\Vnetsetup
 Reshare System\CurrentControlSet\Network\LanMan*sharename*₁
 Username Network\Logon
 WorkGroup System\CurrentControlSet\Services\VxD\Vnetsetup

¹ The equivalent of the Reconnect settings is stored in Hkey_Current_User\Persistent.

The following tables list entries that are retained in SYSTEM.INI for compatibility with applications written for earlier versions of Windows.

SYSTEM.INI Entries Retained and Supported in the User Interface**[386Enh]:**

AlIEMSLocked	Keyboard	MaxPagingFileSize
AlIXMSLocked	KeyPasteCRSkipCount	MinUserDiskSpace
AltKeyDelay	KeyPasteKeyDelay	Mouse
AltPasteDelay	PasteSkipCount	Paging
DMABufferSize	KeyPasteTimeout	PagingDrive
Display	MaxDMAPGAddress	ScrollFrequency
DOSPromptExitInstructions		

[boot]:

display.driv	mouse.driv	sound.driv
keyboard.driv	network.driv	

[NonWindowsApps]:

CommandEnvSize

Entries in SYSTEM.INI Retained but Not Supported in the User Interface**[386Enh]:**

Device= <i>filename</i>	Local Reboot	NetAsyncTimeout
KeybdPasswd	MessageBackColor	NetAsynchFallback
Local	MessageTextColor	NetDMASize

[boot]:

386grabber= <i>filename</i>	fonts.fon= <i>filename</i>	shell= <i>filename</i>
comm.driv= <i>filename</i>	language.dll= <i>library-name</i>	system.driv= <i>filename</i>
drivers= <i>filename</i>	oemfonts.font= <i>filename</i>	TaskMan.Exe= <i>filename</i>
fixedfon.fon= <i>filename</i>		

[drivers]:

alias=*driver-filename*

[mci]:

Entries written by applications

Introduction

This chapter summarizes information about local editions and multilanguage support for Windows 95, and it provides technical details about defining regional settings in setup scripts.

- [Overview of Windows 95 Local Editions](#)
- [Overview of International Language Support](#)
- [Specifying International Settings](#)
 - [Changing Regional Settings in Windows 95](#)
 - [Defining International Settings in Custom Setup Scripts](#)
 - [Changing the Code Page](#)
- [Using Multiple Languages in Windows 95](#)
 - [Using Multilingual Fonts with Win32-Based Applications](#)
 - [Using Alternate Keyboards](#)
 - [Using Windows 95 Support for Local Conventions](#)

Overview of Windows 95 Local Editions

Windows 95 is being made available in the following local versions, among others:

Arabic	Czech	French	Hungarian	Norwegian	Spanish
Basque	Danish	German	Italian	Polish	Swedish
Catalan	Dutch	Greek	Japanese	Portuguese	Turkish
Chinese	Finnish	Hebrew	Korean	Russian	Thai

Windows 95 does not provide support for multiple Windows code pages. Just as with earlier versions of Windows, all international versions of Windows 95 are based on a single Windows code page of 256 code points. The following international versions of Windows 95 are available.

United States.

This version of Windows 95 is based on the American National Standards Institute (ANSI) Windows code page (1252). This is the code page used for most of the single-byte language versions in North America, South America, Western Europe, Scandinavia, South Pacific, Africa, and Asia. This version will be available in English, German, Italian, Norwegian, Swedish, Dutch, French, Spanish, Portuguese, Danish, Finnish, language editions. This version also forms the base for all other versions.

Far East.

This version of Windows 95 is available in Japanese (932), Simplified Chinese (936), Traditional (Taiwan) Chinese (950), and Korean (949). These are the only versions of Windows 95 that support the large character sets and input methods these languages require. They also support a vast array of the unique hardware used in the Far East.

PanEuropean.

This version of Windows 95 allows the user to select the correct Windows code page for their particular language during Setup. After it is installed, the Windows code page cannot be changed. Choices include Cyrillic (1251), Central Europe (1250), Turkish (1254), Greek (1253), and Baltic (1257). This version will be available in Russian, Polish, Hungarian, Greek, Turkish, and other languages.

Middle East.

This version of Windows 95 is available in Arabic (1256) and Hebrew (1255). These are the only versions of Windows 95 that support mixed right-to-left and left-to-right text processing. The Arabic version also includes support for Farsi (Persian).

Thai.

This version of Windows 95 is based on the Thai code page (876).

For information about ordering a local edition of Windows 95, contact your software vendor or your local Microsoft office.

The *Win32 Software Development Kit for Windows 95 and Windows NT* and the Microsoft Developer Network provide complete information about the architecture, APIs, and other needs for developers who are creating or modifying applications to run on local editions of Windows 95. For information about joining the Microsoft Developer Network, see [Windows 95 Resource Directory](#).

The *Windows 95 Resource Kit* is being made available in at least the following local versions: Bahasa, Simplified and Traditional Chinese, Croatian, French, German, Italian, Japanese, Korean, Portuguese, Slovenian, Spanish, Swedish, and Thai. For information about ordering a local edition of *Windows 95 Resource Kit*, contact your local bookseller or your local Microsoft office.

Developing International Software for Windows 95 and Windows NT, a Microsoft Press® book by Nadine Kano, provides details about using the Windows 95 National Language Support (NLS) API and other information about developing software for use in multiple locales. To order this publication (ISBN 1-55615-840-8), contact your local bookseller. You can also order it directly in the United States by calling (800) 677-7377 or through CompuServe® (**go msp**).

Overview of International Language Support

Windows 95 offers international language support to provide solutions to problems created when using software and exchanging documents among different locales and languages. Windows 95 offers this support at the operating system level for users, and at the API level for software developers. This section summarizes this built-in international language support for using Windows 95 on a worldwide basis, and the features that Windows 95 provides for enhancing existing or new applications for use in different parts of the world.

Easy-to-use multilanguage fonts and keyboard layouts.

With Windows 95, users can easily switch between all available languages and corresponding keyboard layouts configured on the system. This makes it easy for users to integrate information into a multilingual document. By using the Keyboard option in Control Panel, users can easily add and remove keyboard layouts and languages. By using the common Choose Font dialog box in applications created for Windows 95, they can choose character-set scripts (such as “Greek”) supported by a particular font. For more information, see [Using Multilingual Fonts with Win32-Based Applications](#) and [Using Alternate Keyboards](#).

Substitution for unavailable fonts when switching languages.

When switching between languages in a document, Windows 95 substitutes matching fonts for the new language if the original font is not available. Users can read and use the text for a similar character set, even if they don't have the font in which the information was originally created.

Preservation of language-specific attributes on the Clipboard.

Windows 95 provides additional services for application vendors to easily exchange information between internationally-aware applications, while preserving all language formatting characteristics.

Easy addition of multilanguage support for software developers.

Developers can use the Win32 NLS API for loading, selecting, and querying keyboard layouts and languages. NLS services ensure that information is handled properly for the given culture or locale by supporting formats for date, time, calendar, number, and currency, and for sorting, character typing, and character mapping. The correct national format for information such as date format or sorting sequence is supplied automatically, based on the settings specified in the Regional Settings option in Control Panel. Win32-based applications can use Windows 95 services to automatically switch between the proper fonts and keyboard layouts as users navigate through a multilingual document. For more information, see [Using Multiple Languages in Windows 95](#).

Proper sorting and formatting rules for the current locale.

Different locales and cultures have different rules for interpreting information, such as algorithms for sorting or searching, and formats for time and dates. Software developers can use the Win32 NLS API to check and use the user's default locale settings or to use a specific locale setting, without using proprietary sorting methods or parsing WIN.INI or the Registry, and without locale-specific coding. This allows users to easily exchange information on a global basis, while preserving the integrity of the information. For example, the multilingual support in Windows 95 can be used in applications to account for these kinds of differences among language rules:

- In French, diacritics are sorted from right to left instead of from left to right as in English.
- In Norwegian, some extended characters follow the Z character because they are considered unique characters rather than characters with diacritics.
- In Spanish, CH is a unique character between C and D, and Ñ is a unique character between N and O.

Specifying International Settings

During Windows 95 Setup, the operating system is configured for a default locale, either based on settings that Setup detects from the previous operating system or based on options that the user chooses. Windows 95 Setup also copies most international information for all other supported locales onto the user's hard disk drive, where applications can access them. You can specify international settings during Windows 95 Setup or change the default settings afterward in Control Panel.

During Setup, you can specify the following settings in the Computer Settings screen:

- Regional settings, for specifying the local language and, in turn, the local conventions for other settings such as date, time, and currency formats. This also sets the MS-DOS code page and MS-DOS country settings.
- Keyboard layout, for specifying the default keyboard layout to be used with Windows 95, based on local requirements. This also sets the MS-DOS keyboard layout.
- Language support, for selecting one of the following combination of languages:
 - English/Western European
 - English/Western European and Greek
 - English/Western European and Cyrillic
 - English/Western European and Central European

Windows 95 selects the English/Western European option by default.

After Setup, you can change the following settings in Control Panel:

- Add languages and corresponding keyboard layouts using the Keyboard option, as described in [Using Alternate Keyboards](#).
- Modify the local language default for settings such as date, time, and currency using the Regional Settings option.
- Add or remove language support (Greek, Cyrillic, or Central European) in the Add/Remove Programs option.

You can configure each of these settings by defining options in custom setup scripts, as described in the following sections. If user profiles are enabled (as described in [User Profiles and System Policies](#)), the international settings preferences in Windows 95 can be saved in each user's profile. In this case, if a single computer is used by multiple users, each user can select a different default locale.

Changing Regional Settings in Windows 95

To change locale conventions after Windows 95 is installed, use the Regional Settings option in Control Panel. This option sets the default system formats for country, language, date, time, currency, and numbers. You can also customize these formats.



To change regional settings in Windows 95



- In the Regional Settings option in Control Panel, click a tab to define settings for that property, as summarized in the following list. When settings are as you want them, click OK.

Properties tab	Description
Regional Settings	Specifies the regional settings you want, to automatically define how dates, times, currency, and numbers are displayed and sorted.
Number	Specifies how numbers are displayed (including the decimal character used), how digits are grouped, and how negative numbers are shown; also specifies the measurement system used.
Currency	Specifies how currency is displayed (including the decimal character used), how digits are grouped, and how negative values are shown.
Time	Specifies how time is displayed, including the hour and minute separator; also specifies how morning and afternoon times are designated.
Date	Specifies the calendar type, and how short and long dates are displayed; also specifies the character used as the separator between the day, the month, and the year.

Defining International Settings in Custom Setup Scripts

You can specify values in the [System] section of a custom setup script (such as MSBATCH.INF) to define regional, keyboard layout, and multilanguage settings other than the defaults.

To specify the regional setting in MSBATCH.INF, set **locale=** in [System] to a value listed in the [LocaleList] section of LOCALE.INF. The following table shows some of the values for regional settings that are available in the United States edition of Windows 95. For local editions of Windows 95, check LOCALE.INF entries for Eastern European, Far Eastern, Middle Eastern, and Thai values.

Regional setting	Value	Regional setting	Value
Afrikaans	L0436	French (Luxembourg)	L140C
Basque	L042D	German (Standard)	L0407
Catalan	L0403	German (Swiss)	L0807
Danish	L0406	German (Austrian)	L0C07
Dutch (Standard)	L0413	German (Luxembourg)	L1007
Dutch (Belgian)	L0813	German (Liechtenstein)	L1407

English (United States)	L0409	Icelandic	L040F
English (British)	L0809	Indonesian	L0421
English (Australian)	L0C09	Italian (Standard)	L0410
English (Canadian)	L1009	Italian (Swiss)	L0810
English (New Zealand)	L1409	Norwegian (Bokmål)	L0414
English (Ireland)	L1809	Norwegian (Nynorsk)	L0814
English (South Africa)	L1C09	Portuguese (Brazilian)	L0416
Finnish	L040B	Portuguese (Standard)	L0816
French (Standard)	L040C	Spanish (Traditional Sort)	L040A
French (Belgian)	L080C	Spanish (Latin American)	L080A
French (Canadian)	L0C0C	Spanish (Modern Sort)	L0C0A
French (Swiss)	L100C	Swedish	L041D

Values listed in the [KeyboardList] section of MULTLNG.INF specify the particular keyboard. Use one of the following strings to define the **keyboard=value** in the [System] section of MSBATCH.INF (or a similar file).

Keyboard layout Keyboard value in MULTLNG.INF

Belgian	KEYBOARD_0000080C
Brazilian	KEYBOARD_00000416
British	KEYBOARD_00000809
Canadian Multilingual	KEYBOARD_00030C0C
Danish	KEYBOARD_00000406
Dutch	KEYBOARD_00000413
Finnish	KEYBOARD_0000040B
French	KEYBOARD_0000040C
French Canadian	KEYBOARD_00000C0C
German	KEYBOARD_00000407
Icelandic	KEYBOARD_0000040F
Italian	KEYBOARD_00000410
Latin American	KEYBOARD_0000080A
Norwegian	KEYBOARD_00000414
Portuguese	KEYBOARD_00000816
Spanish	KEYBOARD_00000C0A
Swedish	KEYBOARD_0000041D
Swiss French	KEYBOARD_0000100C
Swiss German	KEYBOARD_00000807
United States	KEYBOARD_00000409
United States-Dvorak	KEYBOARD_00020409
United States-International	KEYBOARD_00010409

Values listed in the [OptionalComponents] section of MULLANG.INF specify the three optional languages you can add to Windows 95: Greek, Cyrillic, and Central European. Use one of the following

strings to define the **multilanguage=***value* in the [System] section of MSBATCH.INF (or a similar file).

Language Multilanguage value in MULLANG.INF

English	English
Greek	English and Greek
Cyrillic	English and Cyrillic
Central European	English and CE

For more information about creating custom setup scripts, see [Custom, Automated, and Push Installations](#).

Changing the Code Page

The code page is an internal table that the operating system uses to relate the keys on the keyboard to the characters displayed on the screen. Different code pages provide support for the character sets and keyboard layouts used in different countries.

When you install Windows 95, Setup checks the current system configuration to determine the regional settings:

- For Typical Setup, Windows 95 Setup automatically chooses the regional settings for the current system configuration, and then automatically installs the related code pages for Windows and MS-DOS based on the current configuration.
- For Custom Setup, you can choose to specify alternate regional settings. Windows 95 Setup automatically installs the standard Windows and MS-DOS code pages for the regional settings selected.

You can use the Regional Settings option in Control Panel to change the locale. This will affect the display in Windows-based applications. However, for MS-DOS-based applications and for the MS-DOS prompt, the code page installed during Setup is always used. Windows 95 does not include any feature that allows you to change the code page used by MS-DOS.

However, you can use CHANGECP.EXE to change the code page used for console displays (MS-DOS-based applications and the MS-DOS prompt). This application makes all the changes for fonts and other system elements in the Registry and other configuration files. CHANGECP is provided with the *Windows 95 Resource Kit* utilities.

This application is useful to you if your site uses an alternate character set other than the default code page the Windows 95 Setup uses. You know that you need an alternate code page if, after installing Windows 95, your MS-DOS-based applications do not display properly — specifically, if the wrong fonts appear or the wrong characters appear as you type.

For example, the default code page installed for French Canadian under Windows 95 is 850, but your site might use code page 863 as a standard. As another example, the United States default is 437, but some companies choose to use code page 850. In these cases, use CHANGECP to install the alternate code page.



To change the code page used for MS-DOS-based applications

1. Copy CHANGECP.EXE and any other files in the CHANGECP directory with the *Windows 95 Resource Kit* utilities to your local Windows directory.
2. At the command prompt, type **change cp**
3. Select the code page you want from the list that appears.

Alternately, you can type **change cp code_page_number** if you know the code page that you want.

CHANGECP automatically makes all related system changes. The next time you start Windows 95, the new code page will be used for all MS-DOS sessions.

Important The CHANGECP utility is not designed to be used for changing code pages on a regular basis. Also, frequently switching the MS-DOS code page will confuse users of MS-DOS-based applications.

Using Multiple Languages in Windows 95

Windows 95 provides the keyboard layouts and fonts required to type, edit, view and print documents containing many different languages. For information about creating a document that contains multilingual text, see [Using Alternate Keyboards](#). By default, the version of Windows 95 sold in North America, South America, Western Europe, Scandinavia, Africa, and Australia includes the following keyboard languages and layouts.

Windows 95 Languages

Keyboard Indicator	Language	Keyboard Indicator	Language
Af	Afrikaans	Is	Icelandic
Eu	Basque	Ba	Indonesian
Ca	Catalan	It	Italian (Standard)
Da	Danish	It	Italian (Swiss)
Nl	Dutch (Belgian)	No	Norwegian (Bokmål)
Nl	Dutch (Standard)	No	Norwegian (Nynorsk)
En	English (Australian)	Pt	Portuguese (Brazilian)
En	English (British)	Pt	Portuguese (Standard)
En	English (Canadian)	Es	Spanish (Argentina)
En	English (Caribbean)	Es	Spanish (Chile)
En	English (Ireland)	Es	Spanish (Colombia)
En	English (Jamaica)	Es	Spanish (Costa Rica)
En	English (New Zealand)	Es	Spanish (Dominican Republic)
En	English (South Africa)	Es	Spanish (Ecuador)
En	English (United States)	Es	Spanish (Guatemala)
Fi	Finnish	Es	Spanish (Mexican)
Fr	French (Belgian)	Es	Spanish (Modern Sort)
Fr	French (Canadian)	Es	Spanish (Panama)
Fr	French (Luxembourg)	Es	Spanish (Paraguay)
Fr	French (Standard)	Es	Spanish (Peru)
De	German (Austrian)	Es	Spanish (Traditional Sort)
De	German (Liechtenstein)	Es	Spanish (Uruguay)
De	German (Luxembourg)	Es	Spanish (Venezuela)
De	German (Standard)	Sv	Swedish
De	German (Swiss)		

Windows 95 Keyboard Layouts

Belgian (French)	Italian
British	Norwegian
Canadian Multilingual	Portuguese (Brazilian)
Danish	Portuguese (Standard)
Dutch	Spanish
Finnish	Swedish
French	Swiss French

French Canadian

German

Icelandic

Irish

Italian

Swiss German

United States

United States-Dvorak

United States-International

For information about adding or removing any of the languages in the preceding list, see Windows 95 online Help. To add Central European, Cyrillic, and Greek-based languages, you need to install multilanguage support, as described in the following procedure.



To install multilingual support

1. In the Add/Remove Programs option in Control Panel, click the Windows Setup tab.
2. In the Components list, click Language Support, and then click the Details button.
3. Click the languages you want, and then click OK.

When two or more languages are installed, an icon on the taskbar indicates which keyboard is currently active. Users can switch between installed languages by clicking the keyboard icon, or by using a hot-key combination specified in the Keyboard option in Control Panel, as described in [Using Alternate Keyboards](#).

The Windows 95 compact disc includes TrueType® fonts that contain characters for all the Western European and Eastern European languages. After you install multilingual TrueType font support, you can access the complete set of 652 characters in applications that support these fonts, such as WordPad. This allows for proper presentation of fonts for a given language.

An application that uses the common Choose Font dialog box can allow users to select from all the character sets and fonts configured in the system. The Script box in this common dialog box allows the user to choose the characteristics related to the language of the text being formatted. For example, depending on the character set and the locales available on a particular computer, the Script box could allow the user to choose from Western, Greek, Cyrillic, or Turkish characteristics for the selected typeface. Of course, the user must choose the appropriate keyboard for using related text characters.



To access multilingual TrueType fonts in WordPad

1. Click the Format menu, and then click Font.
2. In the Font dialog box, select a font characteristic for the language in the Script box, and then click OK.

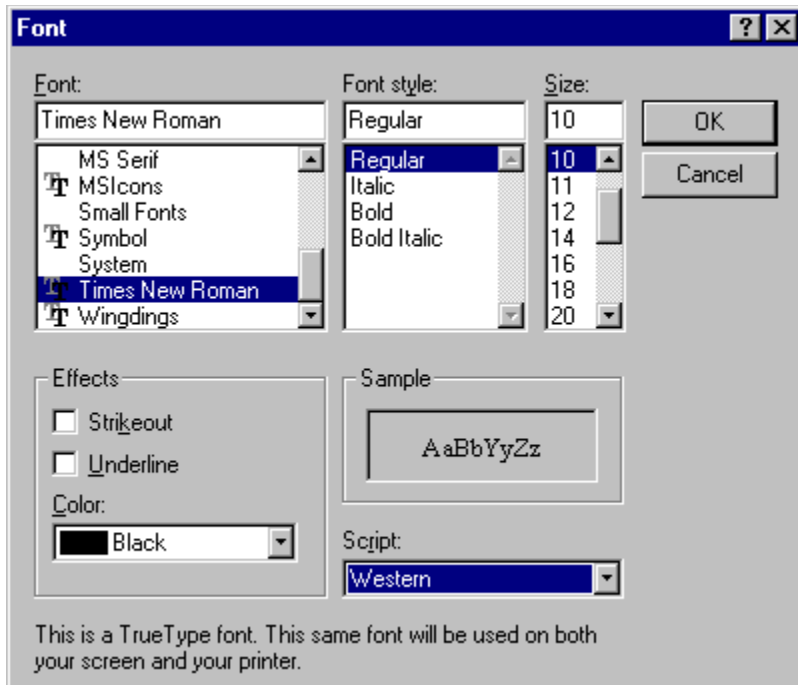

Using Multilingual Fonts with Win32-Based Applications

For users who create or edit multilingual content in their documents, a Win32-based application that uses the international services in Windows 95 can automatically activate the correct fonts and corresponding keyboard layouts for editing specific text within a document.

Win32-based applications can indicate the language used in text in a document by tagging the text with a locale identifier. For example, such applications can automatically use spell checking, thesaurus, hyphenation engine, and grammar checking applications associated with the language of the text it is checking, if they are available. They can also format dates according to the language of the text. Applications that use locale identifiers can determine date, time, currency, and number formats, and sorting behavior, and they can use these identifiers to determine which keyboard layout and fonts to use for typing and displaying text in a particular language.

To take advantage of the multilingual font capabilities in Windows 95:

- Make sure your application uses the Win32 NLS API. For information, check the documentation that comes with the application or contact the software manufacturer.
- Install multilingual support under Windows 95, as described in this topic.
- Use the application's dialog boxes for selecting language-related font attributes and for specifying the language attributes of selected information.

Using Alternate Keyboards

If you are using an application that supports tagging text for alternate locales or languages, you can use alternate keyboards to easily create documents that contain more than one language.



To select the alternate keyboards you want to use in Windows 95

1. In the Keyboard option in Control Panel, click the Language tab.
2. To add another keyboard, click the Add button.
3. In the Add Language dialog box, select the alternate keyboard that you want to install, and then click OK.

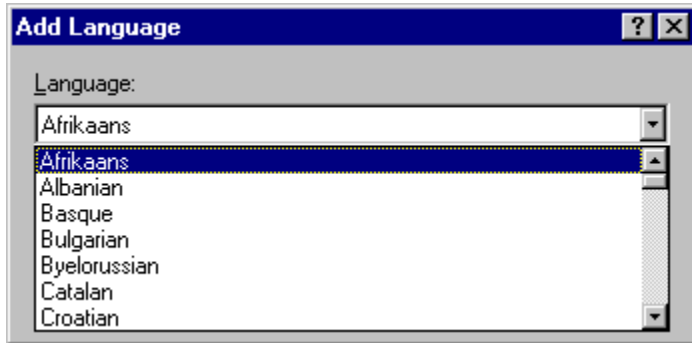

4. If you want to change the default keyboard, select the one you want in the Language list, and then click the Set As Default button.
5. If you want to specify a key combination to use to switch between keyboards, click a key combination in the Switch Languages area.



When you want to switch keyboards while working in an application such as WordPad that can take advantage of multilingual support, use the key combination you specified or use the Windows 95 taskbar.



To switch to another keyboard using the Windows 95 taskbar

1. Click the keyboard icon on the taskbar.
 2. In the menu that appears, click the language you want to use.
- The icon for switching keyboard layouts appears at the right end of the taskbar.

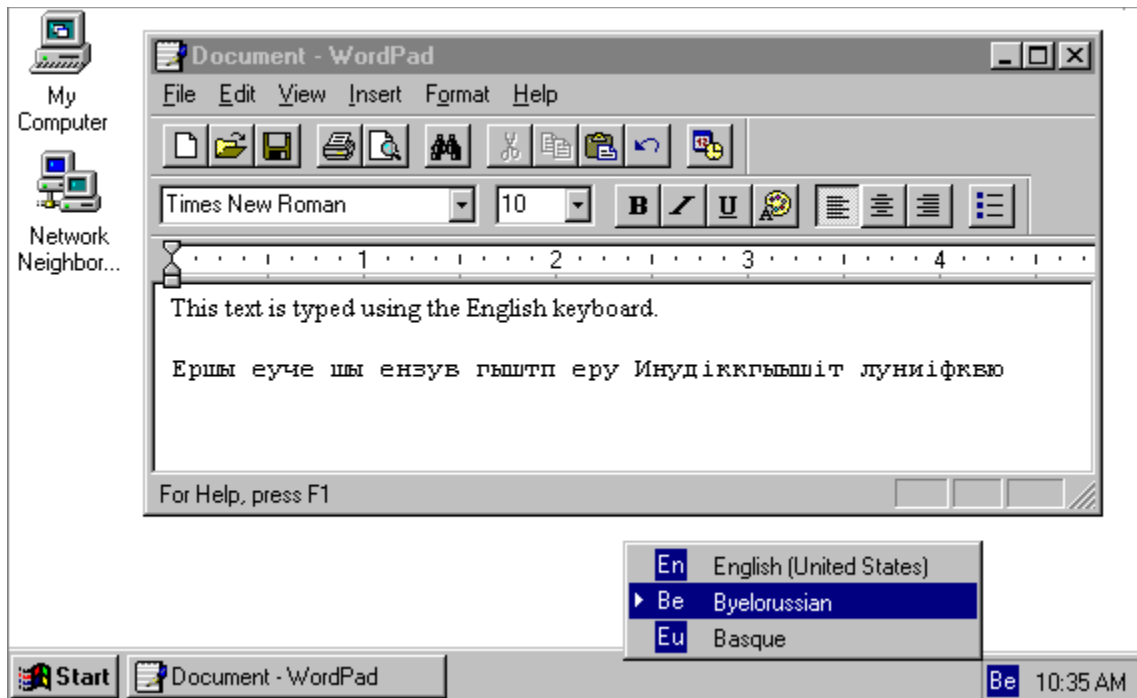

If your application uses the NLS API, you might be able to specify that rules for sorting, searching, spelling, and other actions be used for the portion of text typed using that language. Applications that use the NLS API can distinguish between the default locale the user has set for Windows 95 and the language of text in a document. For example, Microsoft Word for Windows version 6.0 makes language a text property. Just as users can format selected text as bold, italic, or double-spaced, they can format selected text as being in a specific language, as shown in the following illustration.

The Language dialog box in Microsoft Word 6.0 for Windows

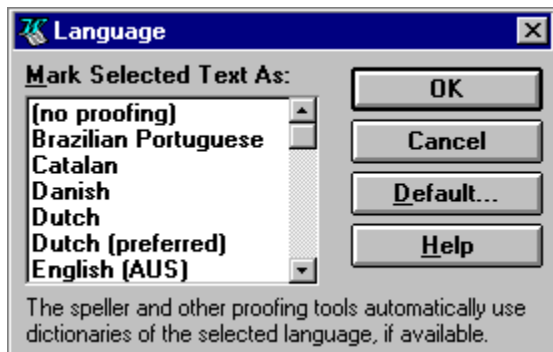

Using Windows 95 Support for Local Conventions

A great deal of linguistic research went into creating the collection of locale information in the Windows 95 Registry and the algorithms and tables used by the Win32 NLS API, which includes support for local formats for date, time, calendars, currency, and numbers. The Windows 95 Registry contains more than 90 locale-related strings; in addition, the Win32 NLS API allows each application to request information for any locale.

The Windows 95 default date or time formats are the most commonly used formats for each locale, but applications can provide support for other local conventions. Such conventions are ways of formatting information specific to a language, local dialect, or geographic location. Currency symbols, date formats, calendars, numerical separators, and sorting orders can all be affected by these conventions.

Therefore, reformatting a number based on the locale involves more than changing the currency symbol or the decimal separator. A currency symbol can come before the numerical quantity or it can come after. It might or might not be separated from the number by spaces. The currency symbol can be one, two, or more characters. In addition, if a currency amount is negative, Windows 95 can format it in one of 16 different ways.

As another example of locale differences, some languages such as Finnish, German, Polish, and Russian have several forms for each noun. Windows 95 carries both the nominative and genitive forms of Polish and Russian month names; the form changes depending on the month name's position in the string relative to the day name. For all other languages, Windows 95 carries only one form of each month or day name.

Most locales use the Gregorian calendar, but some editions of Windows 95 also support Hijri (Middle East), Japanese, Korean, Taiwanese, and Thai calendars. (Windows 95 will add support for more calendars in the future as necessary.) Although calendars in the United States list Sunday as the first day of the week, calendars in other countries, such as Germany, list Monday as the first day of the week. Similarly, not all cultures assume that the week containing January 1 is the first week of the year. The calendar type that Windows 95 assigns to each locale accommodates such cultural preferences.

Introduction

This chapter provides a general approach to troubleshooting, describes built-in Windows 95 features for correcting problems, and includes procedures for identifying and correcting problems.

Note This is a general guide to troubleshooting. For more information, see the troubleshooting sections in other chapters of the *Windows 95 Resource Kit*.

- Troubleshooting Strategy
 - Analyzing Symptoms
 - Checking for Common Issues
 - Isolating and Testing the Error Condition
 - Checking Technical Support Resources
- Windows 95 Troubleshooting Aids for Startup
 - Using Safe Recovery with Windows 95 Setup
 - Verifying Installed Components with Windows 95 Setup
 - Using a Startup Disk

 - Using Windows 95 Startup Menu Options
 - Using WIN.COM Switches
- Troubleshooting Procedures
 - Checking Specific Driver Problems
 - Checking for Correct File Versions
 - Checking for Missing System Files
 - Removing Unnecessary Drivers
 - Checking Whether a Required Driver Is Missing

 - Checking Entries in Startup Files
 - Checking for Conflicts at System Startup
 - Checking Device Configuration
 - Checking for Free Disk Space
 - Isolating File System Errors
 - Checking for Disk Corruption

General Troubleshooting

Troubleshooting Strategy

To troubleshoot problems with Windows 95, follow these basic steps:

- Analyze symptoms and factors
- Check to see if the problem is a common issue
- Isolate the error conditions
- Consult technical support resources

General Troubleshooting

Troubleshooting Strategy

Analyzing Symptoms

Start troubleshooting by analyzing symptoms to determine a strategy for resolving the problem. Under what conditions does the problem occur? Which aspects of the operating system control those conditions? Is the problem specific to a subsystem (networks, video, and so on)?

Consider the following:

- Has the system or configuration ever worked? If so, what changed?
- Is the error condition reproducible or random?
- Is the error specific to a particular system, configuration, or application?
- What specific hardware and firmware is involved?
- Are any non-Windows 95 device drivers or TSRs loaded?
- Does the order by which drivers or applications start up make a difference?
- Does the error still occur with Safe Mode, or Safe Mode with Network Support? (These startup options are described in [Using Windows 95 Startup Menu Options.](#))

Checking for Common Issues

Check to see if the problem is a common issue by reviewing online Help and any .TXT files included on the Windows 95 distribution disks. For example, check SETUP.TXT and README.TXT.

For general information about the problems listed in the following table, see the related chapter in the *Windows 95 Resource Kit*.

Problem	Related chapter reference
Cannot install Windows 95	<u>Setup Technical Discussion</u>
Computer won't start or Windows 95 won't run	<u>Setup Technical Discussion</u>
Network connectivity problem	<u>Introduction to Windows 95 Networking</u>
Local or network printing problem	<u>Printing and Fonts</u>
Application error or general protection fault	<u>Application Support</u>

The Windows 95 online Help includes troubleshooting aids for solving specific problems with the following components of a computer:

- Printing
- Running out of memory
- Freeing disk space
- Hardware conflicts
- Running MS-DOS programs
- Using the network
- Using your modem
- Using Dial-Up Networking
- Using Direct Cable Connection
- Using a portable computer card (PCMCIA)
- Starting Windows 95



To get troubleshooting assistance from Windows 95 Help

1. From the Start button, click Help.
2. At the Contents tab, click Troubleshooting, and then pick a topic from the list.

General Troubleshooting

Troubleshooting Strategy

Isolating and Testing the Error Condition

Eliminating variables helps determine a problem's cause. You can isolate specific causes by removing unnecessary lines in CONFIG.SYS and AUTOEXEC.BAT. Do not remove lines that are necessary to access the hard disk or to run Windows 95 Setup.

You can also isolate the cause by changing a specific value, and then testing to see if the problem has been corrected or altered. For instance, if you suspect a damaged Registry, you could restore the Registry files (SYSTEM.DAT and USER.DAT) from backup files, and then retest.

If a component fails after upgrading to a new driver, replace it with the original driver and retest. If Windows 95 startup fails while loading a real-mode device driver, or if any device driver is suspect in causing an error condition, you can test the effect of not loading a device driver. To bypass individual, real-mode device drivers, press F8 when the Starting Windows message appears and then select the Step-By-Step Confirmation option. (This process is described in detail in [Safe Mode.](#)) Removing protected-mode drivers can be done in Device Manager in the System option in Control Panel.

Test each modification individually to see if it solved the problem. Make note of all modifications and their effect on symptoms. This provides you with the information you need to contact product support personnel, if necessary, and provides an excellent reference for future troubleshooting.

General Troubleshooting

Troubleshooting Strategy

Checking Technical Support Resources

When possible, post persistent problems on the appropriate online forum. Other users may have already discovered, reported, and found workarounds for your problem. Suggestions from others may save you time in tracking down the source of the problem and might give you ideas that can help.

For information about Microsoft TechNet and how to get help from product support using online resources such as The Microsoft Network, see [Windows 95 Resource Directory](#).

General Troubleshooting

Windows 95 Troubleshooting Aids for Startup

Windows 95 contains log files and includes utilities that can assist you in correcting problems that occur during the setup or startup processes. In this section, the following built-in troubleshooting aids are described:

- Safe Recovery with Windows 95 Setup
- Installed components verification
- Startup disk
- Startup Menu options
- WIN.COM switches

Using Safe Recovery with Windows 95 Setup

Setup uses Safe Recovery to determine what caused an installation to fail. Safe Recovery uses the information available in DETCRASH.LOG, for example, to avoid performing detection on the same device that caused Setup to fail before.



To use Safe Recovery if Setup fails

1. Run Setup again.
2. When the Safe Recovery screen appears, click Safe Recovery.

You can also use the SETUPLOG.TXT, DETLOG.TXT, and BOOTLOG.TXT files in the root directory of the boot drive to determine why Setup failed. These text files contain, respectively, the Safe Recovery and hardware detection information in a readable form, plus a log of system startup actions. SETUPLOG.TXT, for example, will show the point at which Setup failed.

To automatically scan these log files for installation or detection errors, you can use the following commands in a setup script. Create a batch file containing the following text and run it from the root directory of the boot drive (C:\) after an unsuccessful Setup attempt.

```
@echo off
echo "Entries found in Setuplog.txt" > log.txt
find /i /n "installtype" setuplog.txt >> log.txt
find /i /n "installdir" setuplog.txt >> log.txt
find /i /n "detection" setuplog.txt >> log.txt
find /i /n "runningapp" setuplog.txt >> log.txt
find /i /n "rootfilesrenamed" setuplog.txt >> log.txt
find /i /n "error" setuplog.txt >> log.txt
find /i /n "failed" setuplog.txt >> log.txt
echo "Entries found in Bootlog.txt" >> log.txt
find /i /n "fail" bootlog.txt >> log.txt
find /i /n "error" bootlog.txt >> log.txt
find /i /n "dynamic load success" bootlog.txt >> log.txt
find /i /n "initcomplete success" bootlog.txt >> log.txt
echo "Entries found in Detlog.txt" >> log.txt
find /i /n "avoidmem" detlog.txt >> log.txt
find /i /n "detected" detlog.txt >> log.txt
find /i /n "error" detlog.txt >> log.txt
cls
type log.txt |more
```

For more information about how Safe Recovery and hardware detection work, and about the contents of the log files, see [Setup Technical Discussion](#).

General Troubleshooting

Windows 95 Troubleshooting Aids for Startup

Verifying Installed Components with Windows 95 Setup

Windows 95 provides an option for verifying installed components when Setup detects an existing Windows 95 installation. When you use the Verify option, Setup reads SETUPLOG.TXT for the installed components and reruns the Setup process to verify all system components. If Verify fails as a result of a missing or damaged file, Setup reinstalls the file. As part of this verification, Setup rebuilds VMM32.VXD and recopies any required files.

Windows 95 also provides a way in the user interface to check whether the version of DLL or support file is current. For information, see [Checking for Correct File Versions](#).

General Troubleshooting

Windows 95 Troubleshooting Aids for Startup

Using a Startup Disk

You can use a Windows 95 startup disk to load the operating system and display an MS-DOS command prompt. The startup disk also contains utilities for troubleshooting a malfunctioning operating system. You can create a startup disk during Windows 95 Setup or afterward in Control Panel.

Caution It is strongly recommended that you create a startup disk as part of Windows 95 Setup, and that you maintain an updated copy of the startup disk each time you change the system configuration after installing Windows 95.

If you did not create a startup disk during Setup, you can create one using a single floppy disk.



To create a startup disk after Windows 95 is installed

- In the Add/Remove Programs option in Control Panel, click the Startup Disk tab. Then click the Create Disk button, and follow the instructions on-screen.

Using Windows 95 Startup Menu Options

If the system fails to start, Windows 95 displays a Startup menu that contains troubleshooting options. You can also manually prompt Windows 95 to display the Startup menu.



To display the Windows 95 Startup menu

- Restart the computer. When the Starting Windows 95 message appears, press F8.

The following table describes Startup menu options. The contents of this menu can vary, depending on the options specified in the MSDOS.SYS, and the configuration of the computer.

Startup menu option	Description
Normal	Starts Windows, loading all normal startup files and Registry values.
Logged (BOOTLOG.TXT)	Runs system startup creating a startup log file. For information about using BOOTLOG.TXT, see Setup Technical Discussion .
Safe Mode	Starts Windows, bypassing startup files and using only basic system drivers. You can also start this option by pressing F5 or typing win /d:m at the command prompt.
Safe Mode with Network Support	Starts Windows, bypassing startup files and using only basic system drivers, including basic networking. You can also start this option by pressing F6 or typing win /d:n at the command prompt.
Step-By-Step Confirmation	Starts Windows, confirming startup files line by line. You can also start this option by pressing F8 when the Startup menu is displayed. For more information, see Step-By-Step Confirmation .
Command Prompt Only ¹	Starts the operating system with startup files and Registry, displaying only the command prompt.
Safe Mode Command Prompt Only ¹	Starts the operating system in Safe Mode and displays only the command prompt, bypassing startup files. Same as pressing SHIFT+F5.
Previous version of MS-DOS	Starts the version of MS-DOS previously installed on this computer. You can also start this option by pressing F4. This option is only available if BootMulti=1 in MSDOS.SYS. ²

¹ When you start the computer at the command prompt, you can use switches with the **win** command to control Windows 95 startup for troubleshooting purposes, as described in [Using WIN.COM Switches](#).

² For information about the options in MSDOS.SYS, see [Setup Technical Discussion](#).

The following sections describe when to use these Startup menu options to troubleshoot system problems.

Tip Windows 95 uses entries in the MSDOS.SYS file to control Startup menu options, automatic loading of certain drivers, and path statements for system files. If Windows 95 does not start as expected, check the entries in MSDOS.SYS.

General Troubleshooting

Windows 95 Troubleshooting Aids for Startup

Using Windows 95 Startup Menu Options

Safe Mode

If Windows 95 fails to start normally, select Safe Mode from the Startup menu to begin troubleshooting. Windows 95 automatically initiates Safe Mode if it detects that system startup failed (for example, if a WNBOOTNG.STS signature file still exists in the Windows directory), or if the Registry is corrupted (for example, if an important key such as SYSTEM is missing), or if an application requests Safe Mode.

Safe Mode bypasses startup files, including the Registry, CONFIG.SYS, AUTOEXEC.BAT, and the [Boot] and [386Enh] sections of SYSTEM.INI, and provides you with access to the Windows 95 configuration files. You can make any necessary configuration changes, and then restart Windows 95 normally.

Use Safe Mode for system startup in situations such as the following:

- If Windows 95 fails to start after the Starting Windows 95 message appears
- If Windows 95 seems to stall for an extended period
- If Windows 95 doesn't work correctly or has unexpected results
- If you cannot print to a local printer after attempting other troubleshooting steps
- If your video display doesn't work correctly
- If your computer stalls repeatedly
- If your computer suddenly slows down
- If you need to test an intermittent error condition

When starting Windows 95 in Safe Mode, only the mouse, keyboard, and standard VGA device drivers are loaded. This makes Safe Mode useful for isolating and resolving error conditions caused by both real-mode and Windows drivers. This option is identical to typing **win /d:m** at the command line, as described in [Using WIN.COM Switches](#).

The Startup menu can include three to four Safe Mode options, depending on whether the computer is compressed, or part of a network. Each Safe Mode option disables a different portion of the startup process, as shown in the following table.

Action	Safe Mode	Safe Mode, Network Support	Command Prompt Only ¹
Process CONFIG.SYS and AUTOEXEC.BAT	-	-	-
Load HIMEM.SYS and IFSHLP.SYS	X	X	-
Process Registry information	-	X	-
Load COMMAND.COM	-	X	X
Load DoubleSpace or DriveSpace if present	X	X	-1
Run Windows 95 WIN.COM	X	X	-
Load all Windows drivers	-	-	-
Load network drivers	-	X	-
Run NETSTART.BAT	-	X	-

¹ For the Safe Mode Command Prompt Only option, also load DoubleSpace or DriveSpace if present.

General Troubleshooting

Windows 95 Troubleshooting Aids for Startup

Using Windows 95 Startup Menu Options

Safe Mode Command Prompt Only

Safe Mode Command Prompt Only loads the COMMAND.COM and DoubleSpace or DriveSpace (if present) files. It does not load HIMEM.SYS, IFSHLP.SYS, or Windows 95.

The following are examples of when to use Safe Mode Command Prompt Only:

- If Windows 95 fails to start, even with the Safe Mode option
- If you want to use command-line switches (such as **win /d:x**)
- If you want to use command line tools (such as editing CONFIG.SYS)
- If you want to avoid loading HIMEM.SYS or IFSHLP.SYS

General Troubleshooting

Windows 95 Troubleshooting Aids for Startup

Using Windows 95 Startup Menu Options

Safe Mode Without Compression

This option appears on the Startup menu only if the computer has a compressed drive. This option loads COMMAND.COM, and does not load any compression drivers. The computer starts at the real-mode command prompt.

The following are examples of when to use Safe Mode Without Compression:

- If the computer stops responding when accessing a compressed drive
- If a Corrupt CVF error occurs during system startup
- If Windows 95 fails to start, and both Safe Mode (F5) and Safe Mode Command Prompt Only (SHIFT+F5) are unsuccessful
- If you want to bypass compression drivers

General Troubleshooting

Windows 95 Troubleshooting Aids for Startup

Using Windows 95 Startup Menu Options

Safe Mode with Network Support

You can use the Safe Mode With Network Support option in networking environments where users might require network connectivity to recover from a system problem. If the operating system starts with Safe Mode but not with Safe Mode with Networking, the network configuration probably requires further adjustment.

The following are examples of when to use Safe Mode with Network Support:

- When Startup stalls and Safe Mode is unsuccessful
- If the computer stops responding when accessing a remote network
- If you cannot print to a network printer
- If the computer is running shared Windows 95 installation

This option loads the following files and drivers:

- HIMEM.SYS and IFSHLP.SYS (irrespective of CONFIG.SYS settings)
- DoubleSpace or DriveSpace drivers (if present)
- Windows 95
- Basic network drivers

It also processes Registry information and runs NETSTART.BAT (if required for real-mode networking from another vendor).

This option does not process CONFIG.SYS and AUTOEXEC.BAT, but does load COMMAND.COM. It only processes AUTOEXEC.BAT if no Windows 95 version of MSDOS.SYS is present, or if the [Paths] section in MSDOS.SYS is invalid and no valid **WinDir=** entry is present.

If the [Paths] section and the **WinDir=** variable are not defined in MSDOS.SYS when you use this option, NETSTART.BAT does not run; only AUTOEXEC.BAT runs, and Windows 95 fails to load.

You cannot use Safe Mode with Network Support when the Registry is corrupted.

Most existing real-mode networks run from the startup files, and all Safe Mode options bypass these files. The NETSTART.BAT file in the Windows directory contains commands for starting Microsoft or NetWare networks. NETSTART.BAT allows Windows 95 to start most real-mode networks on individual computers without running AUTOEXEC.BAT and CONFIG.SYS.



To troubleshoot a system problem if NETSTART.BAT doesn't start the network

1. When the Starting Windows 95 message appears, press F8, and then select the Step-By-Step Confirmation option. (For more information, see the following section.)
2. Answer Yes when prompted to process startup device drivers (CONFIG.SYS) and the startup command file (AUTOEXEC.BAT).
3. Answer Yes to process all network driver lines.

General Troubleshooting

Windows 95 Troubleshooting Aids for Startup

Using Windows 95 Startup Menu Options

Step-By-Step Confirmation

Step-By-Step Confirmation allows you to specify which commands and drivers the system should process by confirming each line of the startup files.

The following are examples of when to use Step-By-Step Confirmation:

- If the startup process fails during loading of the startup files
- If any real-mode drivers must be loaded to run Windows 95 successfully
- If you need to check for Registry failure messages
- If you need to verify that the expected drivers are being loaded
- If you need to temporarily disable a specific driver or set of drivers
- If you need to check for errors in startup files

For information about which drivers are required for system startup, see [Checking Whether a Required Driver Is Missing](#).

When you choose to confirm system startup line by line, the following prompts appear. You can press ENTER to confirm or ESC to skip that part of system startup.

- Load DoubleSpace (or DriveSpace) driver?
- Process the system Registry?
- Create a startup log file (BOOTLOG.TXT)?
- Process your startup device drivers (CONFIG.SYS)?

Each line from CONFIG.SYS is displayed with the [Enter=Y,Esc=N] prompt. You can press TAB when the first CONFIG.SYS prompt appears to accept all options automatically.

- Process your startup command file (AUTOEXEC.BAT)?

Each line from AUTOEXEC.BAT is displayed with the [Enter=Y,Esc=N] prompt. You can press TAB when the first AUTOEXEC.BAT prompt appears to accept all options automatically.

- Run WIN.COM to start Windows 95?
- Load all Windows drivers?

If you press ENTER to answer Yes to each prompt, the result is the same as starting Windows 95 normally except that the logo does not appear. Answering No to "Load All Windows Drivers?" runs Windows 95 in Safe Mode.

General Troubleshooting

Windows 95 Troubleshooting Aids for Startup

Using WIN.COM Switches

The following switches are available to start Windows 95 from the command prompt when you need to isolate an error condition:

win [/d:[f] [m] [n] [s] [v] [x]]

The /d: switch is used for troubleshooting when Windows 95 does not start correctly. The switches in the following table can be used with the /d: switch.

Switc	Description
-------	-------------

h

f Turn off 32-bit disk access. Try this if the computer appears to have disk problems, or if Windows 95 stalls. This is equivalent to **32BitDiskAccess=FALSE** in SYSTEM.INI.

m Starts Windows 95 in Safe Mode.

n Starts Windows 95 in Safe Mode with Networking.

s Specifies that Windows 95 not use ROM address space between F000:0000 and 1 MB for a break point. Try this if Windows 95 stalls during system startup. This is equivalent to **SystemROMBreakPoint=FALSE** in SYSTEM.INI.

v Specifies that the ROM routine should handle interrupts from the hard disk controller. Try this if Windows 95 stalls during system startup or disk operations. This is equivalent to **VirtualHDIRQ=FALSE** in SYSTEM.INI.

x Excludes all of the adapter area from the memory that Windows 95 scans to find unused space. This is equivalent to **EMMExclude=A000-FFFF** in SYSTEM.INI.

General Troubleshooting

Troubleshooting Procedures

This section provides basic instructions for troubleshooting problems that may occur when running Windows 95.

Important Create and keep a startup disk, and verify that it works before you need it. Always make backup copies of configuration files (especially SYSTEM.DAT and USER.DAT).

A particularly good time for backing up files and updating the startup disk is after you install new devices and applications, when you have a good working configuration.

If you try to copy configuration or Registry files from within Windows 95, an error message might appear. In this case, you must remove the system and hidden attributes of the files and copy the files while running in Safe Mode Command Prompt Only to prevent the Registry from being loaded.

Checking Specific Driver Problems

Loading a specific driver in CONFIG.SYS, AUTOEXEC.BAT, or Windows 95 Registry may cause a computer to stall. This could be due to a hardware or software (device driver or TSR) conflict.

To determine whether hardware or software is stalling the computer, try the following:

- Press F8 at the Starting Windows 95 message, and select Safe Mode Command Prompt Only. If this option prevents the computer from stalling on startup, a device driver or TSR is a likely cause of the problem.

Restart the computer, and press F8 again, and then select the Step-By-Step Confirmation option to check for TSRs that are loading and may be causing the problem.

- If you use disk compression and the computer still stalls after using Safe Mode Command Prompt Only to start the computer, restart the computer in Safe Mode Without Compression by pressing CTRL+F5 when the Starting Windows 95 message appears.
- Check the CMOS settings in the computer's BIOS configuration menus, making sure the settings match your installed hardware.
- Check the hardware installation and the manufacturer's documentation to verify that all devices are correctly installed.
- Check resource settings in Device Manager for specific installed hardware to make sure no conflicts exist in the IRQ, I/O address, DMA channels, and memory addresses used. Compare your actual installation with your hardware documentation for inconsistencies in the settings used. For information, see [Devices](#).



To check whether a specific driver is stalling the computer

- Restart the computer. Press F8 when the Starting Windows 95 message appears, and then select the Logged (BOOTLOG.TXT) option. Search the BOOTLOG.TXT file for errors. For information about this file, see [Setup Technical Discussion](#).

General Troubleshooting

Troubleshooting Procedures

Checking for Correct File Versions

In Windows 95, you can view a file's properties to determine its version number and other information such as when it was created. You can use this information to determine whether a DLL or other supporting file is out of date. Notice, however, that not all DLL files display this information.



To view information about a system file

1. In Windows Explorer, right-click the filename, and then click Properties in the context menu.
2. For a supporting or executable file, click the Version tab. Use the Other Version Information list to see details about the file.

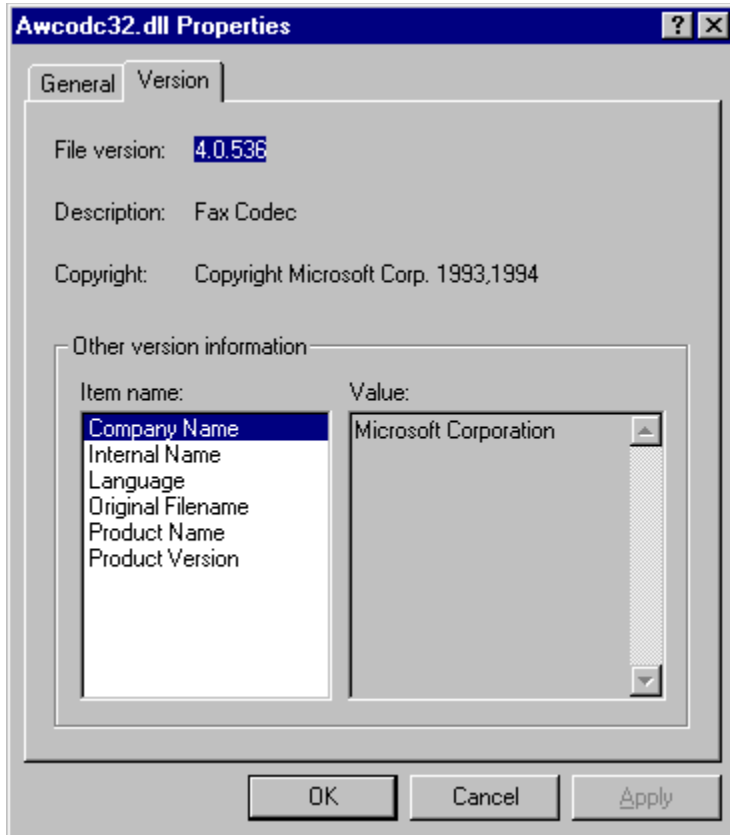

Checking for Missing System Files

A missing operating system file prevents the startup process from continuing. If you are missing only the COMMAND.COM file, you can fix this problem from the Startup menu as described in [Safe Mode Command Prompt Only](#), or from a Windows 95 startup disk as described in this section.

This section also describes how to check and restore the IO.SYS and MSDOS.SYS system files. Windows 95 uses the same names for the real-mode operating system files as MS-DOS does (IO.SYS, MSDOS.SYS, and COMMAND.COM). However, to support dual-boot, the MS-DOS versions of these files are renamed with a .DOS extension when you install or start Windows 95 after having started the computer with the previous operating system.



To replace or reinstall the real-mode operating system files on drive C

1. Start the computer using the Windows 95 startup disk.
2. At the command prompt for the startup drive, type **sys c:** to copy IO.SYS, MSDOS.SYS, DRVSPACE.BIN, and COMMAND.COM to drive C. This rewrites the boot sector.
3. Remove the floppy disk, and then restart the computer.

If COMMAND.COM is missing, a message indicates this and prompts you to type the path for the file.



To restore COMMAND.COM using command-line commands

1. Insert the startup disk into the floppy disk drive.
2. At the command prompt, type the following:

```
attrib -r -s -h c:\command.com  
copy a:command.com c:\
```

If the Windows 95 MSDOS.SYS file is missing, a blue screen presents a message: "Invalid Vxd dynamic link call from IFSMGR (03)." This is followed by an error initializing IFSMGR, and startup fails.

Errors that appear during system startup related to the Registry, XMS, and IFSMGR, are all caused by invalid syntax in the specification of the [Paths] section of MSDOS.SYS or the **WinDir=** entry. Setting the **WinDir=** value causes IO.SYS to use that value to set the following environment variables:

```
tmp=WinDir  
temp=WinDir  
path=WinDir; WinDir\command  
comspec=WinDir\command.com
```

If no valid **WinDir=** entry is found in MSDOS.SYS, the path defaults to C:\WINDOWS, and COMSPEC defaults to C:\COMMAND.COM.

If IO.SYS is missing, the computer stalls before the Starting Windows 95 message appears and displays a message. The message says that the system disk is invalid and prompts you to replace it. You must use a bootable Windows 95 disk (such as the startup disk) to start the computer. You will then need to reinstall the real-mode operating system files on drive C as described in the preceding procedure.

You can also restore the COMMAND.COM in Windows 95.



To restore COMMAND.COM using Windows Explorer

1. Restart the computer, press F8 at the Starting Windows 95 message, and then select the Safe Mode option.
2. Insert the startup disk into the startup drive.
3. Using My Computer or Windows Explorer, find COMMAND.COM on the floppy disk drive, and then drag the file from the floppy disk to the root directory of the boot drive.

General Troubleshooting

Troubleshooting Procedures

Removing Unnecessary Drivers

To determine which drivers should be removed so that they will not be loaded, first try to start the computer without these drivers before removing them from CONFIG.SYS and AUTOEXEC.BAT (and .BAT files called from the AUTOEXEC.BAT).



To determine which drivers can be removed

- Restart the computer, press F8 at the Starting Windows 95 message, and then select the Step-By-Step Confirmation option. Temporarily remove specific drivers or prevent TSRs from loading to determine whether the computer can run successfully without them.

Checking Whether a Required Driver Is Missing

Some computers contain devices that require a specific driver in CONFIG.SYS to correctly complete the startup process, such as drivers used for partitioning, compression, video, hard disks, and so forth.



To check for missing drivers

1. Press F8 when the Starting Windows 95 message appears, and select the Step-By-Step Confirmation option.
2. Respond Yes to all prompts. For any error messages that appear, make note of the driver involved, its location, and the specific wording of the error message. Verify that the specified driver exists in the specified location.

Do not remove any hard disk drivers, disk partitioning drivers, or disk compression drivers when starting Windows 95 using the Step-By-Step Confirmation option or while editing startup files. The following is a partial list of drivers that should not be removed.

Drivers that Should Not Be Removed

Hard disk drivers:

ah1544.sys	ilm386.sys	scsiha.sys	sstbio.sys
aspi4dos.sys	nonstd.sys	skydrvi.sys	sstdrive.sys
atdosxl.sys	scsidsk.exe	sqy55.sys	

Partitioning drivers:

dmdrvr.bin	evdr.sys	ldrive.sys	sstor.sys
enhdisk.sys	fixt_drv.sys	hardrive.sys	

Compression drivers:

dblspace.bin	drvspace.bin	sswap.com
devswap.com	sstor.exe	stacker.com

To find out about other system drivers, see the documentation for the hardware or software installed on the system.

General Troubleshooting

Troubleshooting Procedures

Checking Entries in Startup Files

The CONFIG.SYS and AUTOEXEC.BAT files contain system startup drivers, settings, and paths, and you may need to verify the accuracy of these entries. To determine which drivers to load, press F8 at the Starting Windows 95 message and select Step-By-Step Confirmation.

To check entries in CONFIG.SYS, perform the following tasks:

- Verify that only necessary drivers are loading.
- Check for invalid syntax.

To check entries in AUTOEXEC.BAT, perform the following tasks:

- To display environment variables including COMSPEC, type **set** at the command prompt.
- Verify that paths are valid.

General Troubleshooting

Troubleshooting Procedures

Checking for Conflicts at System Startup

If a computer fails to start Windows 95, try the following tasks:

- Check for upper memory area conflicts. If you suspect an upper memory conflict, use **win /d:x** to start Windows 95.
- Check whether Safe Mode resolves the problem. To verify whether loading minimal drivers will resolve the problem, use F5 or **win /d:m** to start Windows 95.
- Check for conflict with 32-bit disk access. If you don't want to load 32-bit disk access, use **win /d:f** to start Windows 95.
- Check for hard disk I/O conflicts. If you want to force **VirtualHDIRQ=Off**, use **win /d:v** to start Windows 95. For more information, see [Using WIN.COM Switches](#).
- Check for and remove unnecessary drivers and TSRs, and retry.
- Check for device conflicts by using Device Manager in the System option in Control Panel.
- Check for an outdated or damaged VxD by examining the BOOTLOG.TXT and then do the following:
 - If it is in the Windows SYSTEMIOSUBSYS directory, rename it.
 - If it has a .386 filename extension, examine the [386Enh] section of SYSTEM.INI and remark out its lines. When renaming VxDs, be sure to change the .VXD extension. Windows 95 loads all files in the IOSUBSYS subdirectory that have a .VXD extension.
 - If it is in VMM32.VXD, check the Windows SYSTEM\VMM32 directory for a VMM32 file, and rename or move it.

General Troubleshooting

Troubleshooting Procedures

Checking Device Configuration

Errors are sometimes caused by conflicts between devices trying to use the same system resources. Device Manager provides a central place where you can verify that devices are configured correctly and do not conflict with other devices.



To check for resource conflicts among devices

1. In the System option in Control Panel, click the Device Manager tab.
2. Click the + (plus) symbol to the left of the device class, and then double-click a specific device to display its Properties dialog box.
3. Click the Resources tab, and check the Conflicting Device List for conflicts with another device.

Note For network adapters, resource information is provided in the Network option in Control Panel, not in Device Manager.

Also, if you use multiple configurations, you need to first select the appropriate configuration using the list in the device's Resource properties.

General Troubleshooting

Troubleshooting Procedures

Checking for Free Disk Space

Running out of space on the disk drive used for TEMP and swap files can cause a variety of operational and installation errors. If you need more disk space, see the troubleshooting aid for disk space problems in online Help.

To check for free space at the command prompt, try the following:

- Use the **chkdsk** *drive* command at the command prompt to display the available disk space in the Bytes Available on Disk line.
- Use the **dir** *drive* command at the command prompt to view the bytes free at the end of the DIR display.

You might want to check the swap file settings.

For more information about troubleshooting memory problems, see [Performance Tuning](#). See also online Help.



To check the swap file settings

- In the System option in Control Panel, click the Performance tab, and then click the Virtual Memory button.

Important By default, Windows 95 manages the virtual memory settings. Changing these settings can adversely affect system performance. The recommended setting in this dialog box is to let Windows manage virtual memory settings.



To check for lost allocation units from a command line

1. Press F8 when the Starting Windows 95 message appears and select the Safe Mode Command Prompt Only option.
2. Run ScanDisk from the Windows COMMAND directory.
ScanDisk detects lost allocation units, and prompts you to recover them.

For information about running ScanDisk in Windows 95, see [Disks and File Systems](#).



To check the TEMP variable

1. At the command prompt, type **set** to display the TEMP variable.
2. Verify that the TEMP variable points to a valid drive and directory.

Check for free disk space on the drive that contains the TEMP directory. If you are printing multiple copies of a large document, or printing large PostScript documents, increase the minimum available free disk space.

General Troubleshooting

Troubleshooting Procedures

Isolating File System Errors

To determine what is causing file system errors, you generally need to isolate the specific subsystem or component involved. One place to start troubleshooting file system error conditions is through the System option in Control Panel. For information about troubleshooting the file system, see [Performance Tuning](#).

General Troubleshooting

Troubleshooting Procedures

Checking for Disk Corruption

Key operating system data structures prevent system startup if they are damaged. These structures include the master boot record, the boot sector, the file allocation table, and the core operating system files.

Caution Back up key data files before performing any disk repair operations.

Do not run any disk utilities that are not specifically designed for Windows 95. Earlier versions of disk repair utilities may not work properly. To prevent possible data loss, use a disk utility such as ScanDisk which is specifically designed for Windows 95. For details, see [Disks and File Systems](#).



To check for disk corruption with Safe Mode Command Prompt Only

1. Restart the computer, press F8 when the Starting Windows 95 message appears, and then select the Safe Mode Command Prompt Only option.
2. Change to the Windows COMMAND directory, and then type **scandisk**.

This method will also check and repair the file allocation table.

If corruption is detected, you may need to replace system files and structures.

Appendixes

This part of the *Windows 95 Resource Kit* contains supplemental technical information for administrators and users of Windows 95.

Appendix A Command-Line Commands Summary

Lists and describes commands that can be used at the command prompt or in batch scripts in Windows 95. This includes MS-DOS and networking commands, EMM386, commands for ScanDisk, Defrag, and DiskSpace, and TCP/IP commands.

Appendix B Windows 95 System Files

Provides information about the system files supplied with Windows 95, the directory structure, and the standard files installed for various Windows 95 configurations.

Appendix C Windows 95 INF Files

Describes the format of device information (INF) files and provides detailed information on the purpose of each section in the file.

Appendix D MSBATCH.INF Parameters

Defines the setup script parameters and provides setup script examples.

Appendix E Microsoft Systems Management Server

Provides information about Microsoft Systems Management Server and how it can be used to install and maintain Windows 95 on networked computers.

Appendix F Macintosh and Windows 95

Describes how Microsoft Windows NT Server Services for Macintosh makes it possible for computers running Windows 95, MS-DOS, Windows, Windows for Workgroups, Windows NT, and Apple Macintosh to share files and printers.

Appendix G HOSTS and LMHOSTS Files for Windows 95

Describes how to modify HOSTS and LMHOSTS files to support address-to-name resolution on networks that use TCP/IP.

Appendix H Shortcuts for Windows 95

Summarizes the shortcuts built into Windows 95 for using the keyboard and mouse to quickly accomplish common actions. This includes a summary of some accessibility shortcuts.

Appendix I Accessibility

Describes new features in Windows 95 that make Windows 95 more accessible for people with disabilities.

Appendix J Windows 95 Resource Directory

Provides information on obtaining additional support and information for Windows 95 and getting the most out of using Microsoft products.

Introduction

Windows 95 retains and enhances most of the functionality of MS-DOS and LAN Manager. This appendix lists and briefly describes all the command-line commands available in Windows 95. The list includes commands you can use to modify CONFIG.SYS files, write batch programs, and change international settings.

For information about a specific command, use command-line help, which provides syntax, notes about how the command works, and examples of how to use it.



To get information about a command by using command-line help

- At the command prompt, type the command name followed by a space and `/?`
For example, for information about the **dir** command, type **dir /?** at the command prompt.



Command Syntax



Using the Command Prompt

Editing Commands with Doskey and Editing Keys

Pausing or Canceling a Command

Transferring Information to or from a Command-Prompt Window



Native Windows 95 Commands

Network Commands

Commands Used in CONFIG.SYS Files

Commands Used in Batch Programs

Commands Used to Change International Settings

Commands Not Included in Windows 95



Command-Line Switches for Specific Commands

EMM386 Command-Line Switches

Windows Explorer Command-Line Switches

Xcopy Command-Line Switches



Command-Line Switches for Disk Utilities

Defrag

DrvSpace

ScanDisk



TCP/IP Utilities

Arp

Ftp

Nbtstat

Netstat

Ping

Route

Telnet

Tracert

Command Syntax

Syntax is the order in which you must type a command and the elements that follow the command. Commands have up to four elements: *command name*, *parameters*, *switches*, and *values*. In the following illustration, the first example lists all hidden files in the C:\LETTERS directory. The second example allows up to 10 users to connect to the C:\USERS\PUBLIC directory.

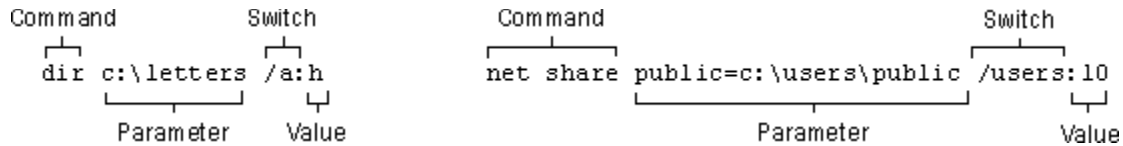

Besides these four elements, command symbols can be used to direct the output. Each element is explained below.

Command Name.

States the action you want Windows 95 to carry out. Some commands (such as the **cls** command, which clears the screen) consist only of a command name. Most commands require more than a name. For all network commands, type **net** followed by a space and the command name, as in the following:

```
net config
```

Parameter.

Defines or creates the object you want Windows 95 to act on. Windows 95 sometimes requires additional information, which you specify in one or more parameters after the command name. For example, the **del** command requires a parameter that is the name of the file you want to delete. Some commands require more than one parameter. For example, to rename a file by using the **rename (ren)** command, you must include the original name of the file in addition to the new name. The following command renames LETTER.TXT to MEMO.TXT:

```
ren letter.txt memo.txt
```

Caution Some commands accept semicolons to separate parameters. For example, if you wanted to delete all files on drive A and typed **del a:*.*** by mistake, Windows 95 would erase the file A in the current directory and all files in the root directory of the current drive.

Position in the syntax line determines how a command works and whether a parameter is a *source* (first) or a *destination* (second). In the example above, the source, LETTER.TXT, specifies the location of data to be transferred or used as input to a command. The destination, MEMO.TXT, specifies a location to which the data specified by source is to be transferred.

Switches.

Modify how a command performs a task. A switch is a forward slash (/) or a hyphen (-), usually followed by words, letters, or numbers. Some commands do not have switches, whereas others have several. If a command has more than one switch, you type them one after the other, separated with a space. Switches can be in any position or order after the command name. Some commands accept more than one switch after a forward slash. Other commands, such as TCP/IP utilities, accept a hyphen (-) instead of the forward slash.

Tip The terms “parameter” and “switch” are often interchanged, since both elements follow the command name. The only meaningful difference between a switch and parameter is the presence of a forward slash or hyphen to indicate a switch and the parameter position in the syntax line to indicate whether the parameter is a source or a destination. The term “argument” is also used to refer to parameters or switches.

With some network commands for real-mode networking, a prompt appears that requires a user response before a task can be completed. To force a Yes or No answer for all responses, append the **/yes (/y)** or **/no (/n)** switch to a command. For example, stopping the workstation service when working in Command Prompt Only mode causes Windows 95 to stop dependent services; Windows 95 prompts you before stopping each dependent service unless the **/yes** switch is included, as in the following:

net stop workstation /y

Value.

Determines how a switch works. A value is a colon (:), or an equal sign (=), followed by a word, letter, or number and must immediately follow the switch it modifies without a space. The following example of the **format** command contains two values — the file system to use (VFAT in the following example) and a volume label (Backup2):

format d: /f:1.2 /v:backup2

Check the syntax for the specific command in online Help to determine whether the command you want to use requires an equal sign or a colon.

Command symbols.

Direct the input or output of a command and permit conditional execution of a command. Used with commands and filter commands, the command symbols are powerful tools.

Symbol	Purpose
>	Redirects output.
>>	Appends redirected output to existing data.
<	Redirects input.
	Pipes output.

Sort, **more**, and **find** are the built-in filter commands that work in the same way as command symbols, to allow you to sort input and output, cause output to the screen to be displayed one screen at a time, and search for specified text in a file.

Using the Command Prompt

This section explains how to:

- Simplify entry of repetitive commands.
- Pause or cancel execution of a command.
- Cut and paste information to or from a command-prompt window.

Editing Commands with Doskey and Editing Keys

Windows 95 provides Doskey to give you quick access to your most recent commands and enable you to assign frequently used commands to a single keystroke. Doskey is also available for character-based programs that accept buffered input. Doskey allows you to assign multiple commands to a single key or a typed alias. In addition to Doskey, several editing keys allow you to use and edit the last command you typed, as described in the following table.

Keys for Editing at the Command Prompt

Key	Description
-----	-------------

Doskey:

UP ARROW or DOWN ARROW	Cycles through commands previously entered.
F7	Displays all of the previous commands in a list. Press F9 and then choose a number from the list, and press ENTER (or press ESCAPE cancel).

Other editing keys:

F1	Displays the last command one character at a time.
F3	Displays the entire command.
BACKSPACE or LEFT ARROW	Moves the cursor in a command.
INS	Toggles between insert and overwrite mode.

Pausing or Canceling a Command

You can pause or stop the output of a command.



To pause the output of a command

- Press CTRL+S or PAUSE.

Press any key except PAUSE to restart the output of the command. You can stop and restart the output of a command as many times as you want.



To stop Windows 95 from completing a command

- Press CTRL+BREAK or CTRL+C.

Important Any action Windows 95 carried out before you pressed CTRL+BREAK or CTRL+C cannot be undone.

Transferring Information to or from a Command-Prompt Window

You can transfer information to or from the command prompt. The following topics describe how to do this using the Edit buttons in a window or using QuickEdit mode in a window or in full-screen mode.

In full-screen mode, you can also use the Edit menu commands to copy and paste information in any window, not just command-prompt windows. The data is transferred as text or as a bitmap to the Clipboard depending on how it was copied.

Tip To quickly switch a command prompt or MS-DOS-based application between a full screen and a window, press ALT+ENTER.

Copying and Pasting Information Using Edit Buttons

When running MS-DOS Prompt or an MS-DOS-based application in a window, you can use the Edit buttons to copy and paste text at the command prompt.



To select and copy text at the command prompt



1. Click the Mark button, and then select the text you want to copy, using either the mouse or the arrow keys.



2. Click the Copy button.

This places the selected text on the Clipboard, so you can paste it anywhere, not just at the command line.



To paste text at the command prompt

1. Make sure the text you want is on the Clipboard.

This text can come from any source, not just from the command line.



2. Place the insertion point where you want to paste it, and then click the Paste button.

Copying and Pasting Information Using QuickEdit Mode

QuickEdit mode allows you to copy and paste text in command-prompt windows using only the mouse, bypassing the Edit commands. QuickEdit mode copies data only when the command prompt is running as a window; however, you can paste text either in a window or a full screen.

Note When QuickEdit mode is on, the mouse works as usual in MS-DOS-based applications that are running in a full screen; the mouse does not work when such applications run in a window if QuickEdit mode is on. Use the **start** command to retain use of the mouse when starting a program from a command-prompt window with QuickEdit mode enabled.



To copy and paste text at the command prompt using QuickEdit mode

1. If necessary, turn on QuickEdit mode in the window properties.
2. Position the pointer at the beginning of the text you want to copy. Press the left mouse button. Keeping the left mouse button depressed, drag the cursor to the last character of the section you want to copy and release the left mouse button. The portion of the screen you want to copy is highlighted.
3. Right-click to copy the highlighted area to the Clipboard. The highlight will disappear.
4. Right-click to copy the contents of the Clipboard to the command-prompt cursor. If you copy more than one line, a carriage return (CR) is added at the end of each line.

You must still use the Paste command from the Edit menu to paste the contents of the Clipboard into Windows-based applications.

Native Windows 95 Commands

A *native* command takes advantage of the 32-bit operating system. Most commands familiar to MS-DOS users are now native Windows 95 system commands.

Some commands, such as **dir** and **chdir**, are *internal*, meaning the command resides in memory at all times. Internal commands can be run at the command prompt and in batch files.

Other commands, such as **drvspace** and **xcopy**, are *external*, meaning the command is stored in its own file and loads from disk when you use the command. External commands can be run at the command prompt, from Windows Explorer, from the Run command, or from the Start menu, and can also be run in batch files. Batch commands are for use in batch programs only.

The following tables summarize the commands included with Windows 95. Unless otherwise specified, you can type these commands at the command prompt.

Internal¹ and External² Commands

Command	Purpose
attrib ²	Displays or changes file attributes.
break ¹	Sets or clears extended CTRL+C checking.
cd ¹	Displays the name of the current directory or changes the current directory.
chcp ¹	Displays the number of the active character set (code page). You can also use this command to change the active character set for all devices that support character-set switching.
chdir ¹	See the cd command.
chkdsk ²	Checks the status of a disk and displays a status report. Can also fix disk errors. However, Windows ScanDisk (scandiskw) is the recommended command for repairing disks.
cls ¹	Clears the screen.
command ²	Starts a new instance of the command interpreter.
copy ¹	Copies one or more files to the location you specify.
ctty ¹	Changes the terminal device used to control the computer.
date ¹	Displays the date and prompts you to change the date, if necessary.
drvspace ²	Compresses hard disk drives or floppy disks, and configures drives that were compressed by using DriveSpace or DoubleSpace. This is a Windows-based utility; for information, see the syntax description.
debug ²	Starts the Debug program, which you can use to test and debug executable files.
defrag ²	Reorganizes the files on a disk to optimize disk performance. This is a Windows-based utility; for information, see the syntax description.
del (erase) ¹	Deletes the files you specify.
deltree ²	Deletes a directory and all the files and subdirectories that are in it.
dir ¹	Displays a list of the files and subdirectories that are in the current or specified directory.
diskcopy ²	Copies the entire contents of one floppy disk to another floppy disk.

doskey₂ Loads the Doskey program into memory. The Doskey program recalls command-line commands, and it enables you to edit command lines and create and run macros. Doskey loads by default.

edit₂ Starts a text editor you can use to create and edit ASCII text files.

emm386₂ Enables or disables EMM386 expanded-memory support. Also provides support for loading real-mode device drivers in the upper memory area (UMA) if both EMM386.EXE and HIMEM.SYS are loaded with **device=** commands in CONFIG.SYS.

erase₁ See the **del** command.

exit₁ Quits the command interpreter (COMMAND.COM) and returns to the program that started the command interpreter, if one exists.

expand₂ Decompresses a compressed file.

fc₂ Compares two files and displays the differences between them.

fdisk₂ Starts the Fdisk program, which configures a hard disk for use with Windows 95. Although you can run this command at the command prompt, you cannot use it while running Windows 95 on the drive that contains the Windows system files.

find₂ Searches for a specific string of text in a file or files.

for₂ Runs a specified command for each file in a set of files.

format₂ Formats a disk for use with Windows 95 or MS-DOS. You can use the right-click a drive icon in Windows Explorer to use a Windows-based version of this command.

keyb₂ Starts the Keyb program, which configures a keyboard for a specific language.

label₂ Creates, changes, or deletes the volume label (name) of a disk.

lh₁ See the **loadhigh** command.

loadfix₂ Ensures that a program is loaded above the first 64K of conventional memory.

loadhigh (lh)₁ Loads a program into upper memory.

md₁ Creates a directory or subdirectory.

mem₂ Displays the amount of used and free memory on the computer.

mkdir₁ See the **md** command.

mode₂ Configures a printer, serial port, or display adapter; sets the typematic rate; redirects printer output from a parallel port to a serial port; prepares, selects, refreshes, or displays the numbers of the character sets (code pages) for parallel printers or the keyboard and screen; displays the status of all the devices installed on the computer.

more₁ Displays one screen of output at a time.

move₂ Moves one or more files to the location you specify. Can also be used to rename files and directories.

nlsfunc₂ Starts the Nlsfunc program, which loads country-specific

	information for national language support (NLS).
path ₁	Indicates which directories the operating system should search for executable files (programs).
prompt ₁	Changes the appearance of the command prompt.
rd ₁	Deletes (removes) a directory.
ren ₁	Changes the name of the file or files you specify.
rename ₁	See the ren command.
rmdir ₁	See the rd command.
scandisk ₂	Checks disks and the file system for damage, and repairs them, if needed. Windows ScanDisk (scandisk) is the recommended command for repairing disks.
set ₁	Displays, sets, or removes environment variables.
setver ₂	Displays the version table. Reports a version number to programs or device drivers designed for earlier versions of MS-DOS.
smartdrv ₂	Starts or configures SMARTDrive, which creates a disk cache in extended memory. Important Under Windows 95, do not place the smartdrv command in AUTOEXEC.BAT. Windows 95 uses another method of disk caching.
sort ₂	Reads input, sorts data, and writes the results to the screen, a file, or another device.
start /W ₂	Allows you to run a Windows-based program from the command line and wait for it. For information about other switches that can be used with start , see the online Help for the command.
subst ₂	Associates a path with a drive letter.
sys ₂	Creates a startup disk by copying hidden Windows 95 system files and the command interpreter (COMMAND.COM) to the disk.
time ₁	Displays the system time or sets the computer's internal clock.
type ₁	Displays the contents of a text file.
ver ₁	Displays the operating system version number.
verify ₁	Directs the operating system to verify that files are written correctly to a disk, and displays the status of verification.
vol ₁	Displays the volume label and serial number for a disk, if the disk has them.
xcopy ₂	Copies directories, their subdirectories, and files (except hidden and system files). For information, see the syntax description.

1 Internal commands can be used in batch files and at the command prompt.

2 External commands can be run from the command prompt or in batch files, or can be run from Windows Explorer, the Run command, or other parts of the Windows 95 user interface.

configuration files such as AUTOEXEC.BAT. Some commands are applicable only in real mode, such as before Windows 95 starts, or if your computer uses only real-mode networking.

Command	Purpose
net config	Displays the controllable services that are running.
net diag	Runs the Microsoft Network Diagnostic program to display diagnostic information about your network.
net help or net /?	Provides a list of network commands and topics you can get help with, or provides help with a specific command or topic.
net init ₁	Loads protocol and network adapter drivers without binding them. This may be necessary for network adapter drivers from other vendors. You can bind them using net start bind .
net logoff _{1,2}	Breaks the connection between your computer and the network resources to which it is connected.
net logon _{1,2}	Identifies you as a member of a workgroup.
net password _{2,3}	Changes your logon password.
net print ₂	Displays or controls print jobs.
net start ₁	Starts a service or displays a list of started services.
net stop ₁	Stops a network service.
net time	Synchronizes the computer's clock with that of a server or domain, or displays the time for a server or domain.
net use	Connects a computer to or disconnects it from a shared resource, or displays information about computer connections.
net ver	Displays the type and version number of the network redirector you are using.
net view	Displays a list of servers or displays resources being shared by a server.

- 1 This command is available only in real mode, and cannot be used in a VM window.
- 2 This command is not supported for NetWare NCP servers.
- 3 The form **net password /domain:name** or **net password \\server** can be used in a VM window. However, the standard form of **net password** is available only in real mode, and cannot be used in a VM window.

Command-Line Commands Summary
Native Windows 95 Commands

Commands Used in CONFIG.SYS Files

You can use the commands listed in the following table in CONFIG.SYS files.

Command	Purpose
break	Sets or clears extended CTRL+C checking. You can use this command at the command prompt or in a batch file.
buffers and bufferhigh	Allocates memory for a specified number of disk buffers when the computer starts. The bufferhigh ₁ form causes reserved memory to be taken out of the UMA. You can use these commands only in CONFIG.SYS.
country	Enables the operating system to use country-specific conventions for displaying dates, times, and currency; for determining the order by which characters are sorted; and for determining which characters can be used in filenames. You can use this command only in CONFIG.SYS.

device	Loads the device driver you specify into memory. You can use this command only in CONFIG.SYS.
devicehigh	Loads the device driver you specify into upper memory. You can use this command only in CONFIG.SYS.
dos	Specifies that the operating system should maintain a link to the UMA, load part of itself into the high memory area (HMA), or both. You can use this command only in CONFIG.SYS.
drivparm	Defines parameters for devices such as disk and tape drives when you start the operating system. You can use this command only in CONFIG.SYS.
fcbs or fcshigh	Specifies the number of file control blocks (FCBs) that the operating system can have open at the same time. The fcshigh form causes reserved memory to be taken out of the UMA. You can use these commands only in CONFIG.SYS.
files or fileshigh	Specifies the number of files that the operating system can access at one time. The fileshigh form causes reserved memory to be taken out of the UMA. You can use these commands only in CONFIG.SYS.
include	Includes the contents of one configuration block within another. You can use this command only in CONFIG.SYS.
install	Loads a memory-resident program into memory. You can use this command only in CONFIG.SYS.
lastdrive or lastdrivehigh	Specifies the maximum number of drives you can access. The lastdrivehigh form causes reserved memory to be taken out of the UMA. You can use these commands only in CONFIG.SYS.
menucolor	Sets the text and background colors for the startup menu. You can use this command only within a menu block in CONFIG.SYS.
menudefault	Specifies the default menu item on the startup menu and sets a time-out value, if desired. You can use this command only within a menu block in CONFIG.SYS.
menuitem	Defines up to nine items on the startup menu. You can use this command only within a menu block in CONFIG.SYS.
numlock	Specifies whether the NUMLOCK setting on the numeric keypad is set to ON or OFF. You can use this command only within a menu block in CONFIG.SYS.
rem	Enables you to include comments (remarks) or prevent commands in a batch program or CONFIG.SYS from running.
shell	Specifies the name and location of the command interpreter you want Windows 95 to use. You can use this command only in CONFIG.SYS.
stacks or stackshigh	Supports the dynamic use of data stacks to handle hardware interrupts. The stackshigh form causes reserved memory to be taken out of the UMA. You can use these commands only in CONFIG.SYS.
submenu	Defines an item on a startup menu that, when selected, displays another set of choices. You can use this command only within a menu block in CONFIG.SYS.

switches Specifies special options. Used only in CONFIG.SYS.

¹ Windows 95 automatically reserves memory in the UMA unless CONFIG.SYS contains the entry **dos=noauto** or if HIMEM.SYS and EMM386 are not loaded.

The following device drivers can be loaded in CONFIG.SYS using a **device=** statement.

Device driver Description

- display.sys** Enables you to display international character sets on EGA, VGA, and LCD monitors. This device driver must be loaded by a **device** or **devicehigh** command in CONFIG.SYS.
- driver.sys** Creates a logical drive that you can use to refer to a physical floppy disk drive. This device driver must be loaded by a **device** or **devicehigh** command in CONFIG.SYS.
- emm386.exe** Provides support for loading real-mode device drivers in the UMA if both EMM386.EXE and HIMEM.SYS are loaded with **device=** commands in CONFIG.SYS.
- himem.sys** Himem is an extended-memory manager — a program that coordinates the use of your computer's extended memory, including the HMA, so that no two applications or device drivers use the same memory at the same time. This device driver must be loaded by a **device** command in CONFIG.SYS, and the command line must come before any commands that start applications or device drivers that use extended memory.
- keyboard.sys** Enables the operating system to use a keyboard other than the standard U.S. QWERTY keyboard layout. You can use this command only in CONFIG.SYS.
- mscdex.exe** Provides access to CD-ROM drives.

Command-Line Commands Summary

Native Windows 95 Commands

Commands Used in Batch Programs

Batch programs (also called batch files) allow you to simplify routine or repetitive tasks. A *batch program* is an unformatted text file that contains one or more commands and has a .BAT or .CMD filename extension. When the filename is typed at the command prompt, the commands in the file are run sequentially.

Any command can be included in a batch file. In addition, several commands allow conditional processing of the commands in the batch file. For example, the **if** command carries out a command based on the results of a condition. Other commands allow you to control input and output and to call other batch programs. You can use the following commands in batch programs.

Commands for Use in Batch Files

Command Purpose

- call** Calls one batch program from another without causing the first batch program to stop.
- choice** Prompts the user to make a choice in a batch program. Displays a specified prompt and pauses for the user to choose from among a specified set of keys.
- echo** Displays or hides the text in batch programs when the program is running. Also indicates whether command-echoing is on or off.
- for** Runs a specified command for each file in a set of files. You can use this command in batch programs or at the command

	prompt.
goto	Directs the operating system to a line in a batch program that is marked by a label you specify. You can use this command only in batch programs.
if	Performs conditional processing in batch programs. You can use this command only in batch programs.
pause	Suspends processing of a batch program and displays a message that prompts you to press any key to continue. You can use this command only in batch programs.
rem	Enables you to include comments (remarks) or prevent commands in a batch program or CONFIG.SYS from running.
shift	Changes the position of replaceable parameters in a batch program. You can use this command only in batch programs.

Command-Line Commands Summary

Native Windows 95 Commands

Commands Used to Change International Settings

You can use the following commands to change international settings such as country codes, keyboard layouts, and character sets (code pages):

chcp	keyb	nlsfunc
country	mode	

Command-Line Commands Summary

Native Windows 95 Commands

Commands Not Included in Windows 95

The following commands are not included with the basic Windows 95 files:

append¹	graftabl	monoumb.386¹	romdrive.sys
assign	graphics¹	msav	share
backup¹	help	msbackup¹	sizer¹
chkstate.sys¹	instsupp.bat¹	power	smartmon
comp	interlnk¹	print¹	tree¹
dosshell	intersvr¹	printer.sys	undelete¹
edlin¹	join	qbasic¹	unformat
ega.sys	loadfix¹	ramdrive.sys	vsafe
expand¹	memcard	recover	
fasthelp	memmaker¹	replace¹	
fastopen	mirror	restore¹	

¹ This command is available in the OTHER\OLDDOS directory on the Windows 95 compact disc.

Command-Line Commands Summary

Command-Line Switches for Specific Commands

This section describes command-line switches for certain commands or executable files that are of particular interest in Windows 95. These include the following:

- **emm386**
- **explorer** (Windows Explorer)
- **xcopy**

Command-Line Commands Summary

Command-Line Switches for Specific Commands

EMM386 Command-Line Switches

This section provides correct syntax and other details for using EMM386 command-line switches.

EMM386

Enables or disables EMM386 expanded-memory support.

The EMM386 device driver, EMM386.EXE, provides expanded-memory support and also provides access to the upper memory area. For information about EMM386.EXE, see its entry later in this section.

Syntax

emm386 [on|off|auto] [w=on|w=off]

To display the current status of EMM386 expanded-memory support, type **emm386** at the command prompt:

Parameters

on|off|auto

Activates the EMM386 device driver (if set to **on**), or suspends the EMM386 device driver (if set to **off**), or places the EMM386 device driver in auto mode (if set to **auto**). Auto mode enables expanded-memory support only when a program calls for it. The default value is **on**.

w=on|w=off

Enables (if set to **w=on**) or disables (if set to **w=off**) Weitek coprocessor support. The default value is **w=off**.

Notes on EMM386

Installing the EMM386.EXE device driver.

To use the **emm386** command, you must also install the EMM386.EXE device driver by using the **device** command in CONFIG.SYS.

Reactivating EMM386 expanded-memory support.

If EMM386 was loaded when the VM was started but is not currently in use, the **on** parameter reactivates expanded-memory support.

Suspending EMM386 expanded-memory support.

If EMM386 expanded-memory support is currently active, handle 0 is the only handle allocated, and EMM386 is not providing access to the upper memory area. The **off** parameter suspends EMM386 expanded-memory support. When EMM386 expanded-memory support is off, the EMM386.EXE device-driver header is changed so that programs cannot use expanded memory. This enables you to run programs that do not comply with the Virtual Control Program Interface (VCPI).

EMM386.EXE

Caution Use EMM386.EXE parameters carefully. You can make the computer inoperable if you use them incorrectly.

Provides access to the upper memory area and uses extended memory to simulate expanded memory. This is for MS-DOS-based applications that need expanded memory. The EMM386.EXE device driver must be loaded by a **device** command in CONFIG.SYS. EMM386 uses extended memory to simulate expanded memory for programs that can use expanded memory. EMM386 also makes it possible to load programs and device drivers into upper memory blocks (UMBs).

Note The EMM386.EXE device driver is different from the EMM386 command used to enable expanded-memory support.

Syntax

device=[drive:][path]emm386.exe [on|off|auto] [memory] [min=size]
[mx|frame=address|pmmmm] [pn=address] [x=mmmm-nnnn]
[i=mmmm-nnnn] [b=address] [L=minXMS] [a=altregs] [h=handles]
[d=nnn] [ram=mmmm-nnnn] [noems] [novcpi] [highscan] [verbose]
[win=mmmm-nnnn] [nohi] [rom=mmmm-nnnn] [nomovexbda] [altboot]

Parameters

[drive:path]

Specifies the location of the EMM386.EXE file.

on|off|auto

Activates the EMM386 device driver (if set to **on**), or suspends the EMM386 device driver (if set to **off**), or places the EMM386 device driver in auto mode (if set to **auto**). Auto mode enables expanded-memory support and upper memory block support only when a program calls for it. The default value is **on**. Use the **emm386** command to change this value after EMM386 has started.

memory

Specifies the maximum amount of extended memory (in kilobytes) that you want EMM386 to provide as expanded/Virtual Control Program Interface (EMS/VCPI) memory. This amount is in addition to the memory used for UMBs and EMM386 itself. Values for *memory* are in the range 64 through the lesser of either 32768 or the amount of extended memory available when EMM386 is loaded. The default value is the amount of free extended memory. If you specify the **noems** switch, the default value is 0. EMM386 rounds the value down to the nearest multiple of 16.

Switches

min=size

Specifies the minimum amount of EMS/VCPI memory (in kilobytes) that EMM386 will provide, if that amount of memory is available. EMM386 reserves this amount of extended memory for use as EMS/VCPI memory when EMM386 is loaded by **device=emm386.exe** in CONFIG.SYS. EMM386 may be able to provide additional EMS/VCPI memory (up to the amount specified by the *memory* parameter) if sufficient XMS memory is available when a program requests EMS/VCPI memory. Values are in the range 0 through the value specified by the *memory* parameter. The default value is 256. If you specify the **noems** switch, the default value is 0. If the value of **min** is greater than the value of *memory*, EMM386 uses the value specified by **min**.

mx

Specifies the address of the page frame. Valid values for *x* are in the range 1 through 14. The following list shows each value and its associated base address in hexadecimal format:

1 => C000h	5 => D000h	9 => E000h	12 => 8800h
2 => C400h	6 => D400h	10 => 8000h	13 => 8C00h

3 => C800h 7 => D800h 11 => 8400h 14 => 9000h
4 => CC00h 8 => DC00h

frame=address

Specifies the page-frame segment base directly. To specify a specific segment-base address for the page frame, use the **frame** switch and specify the address you want. Valid values for *address* are in the ranges 8000h through 9000h and C000h through E000h, in increments of 400h. To provide expanded memory and disable the page frame, you can specify **frame=none**; however, this may cause some programs that require expanded memory to work improperly.

lpmmmm

Specifies the address of the page frame. Valid values for *mmmm* are in the ranges 8000h through 9000h and C000h through E000h, in increments of 400h.

pn=address

Specifies the segment address of a specific page, where *n* is the number of the page you are specifying and *address* is the segment address you want. Valid values for *n* are in the range 0 through 255. Valid values for *address* are in the ranges 8000h through 9C00h and C000h through EC00h, in increments of 400h. The addresses for pages 0 through 3 must be contiguous in order to maintain compatibility with version 3.2 of the Lotus/Intel/Microsoft Expanded Memory Specification (LIM EMS). If you use the **mx** switch, the **frame** switch, or the **lpmmmm** switch, you cannot specify the addresses for pages 0 through 3 for the **lpmmmm** switch.

x=mmmm-nnnn

Prevents EMM386 from using a particular range of segment addresses for an EMS page or for UMBs. Valid values for *mmmm* and *nnnn* are in the range A000h through FFFFh and are rounded down to the nearest 4-kilobyte boundary. The **x** switch takes precedence over the **i** switch if the two ranges overlap.

i=mmmm-nnnn

Specifies a range of segment addresses to be used (included) for an EMS page or for UMBs. Valid values for *mmmm* and *nnnn* are in the range A000h through FFFFh and are rounded down to the nearest 4-kilobyte boundary. The **x** switch takes precedence over the **i** switch if the two ranges overlap.

b=address

Specifies the lowest segment address available for EMS "banking" (swapping of 16-kilobyte pages). Valid values are in the range 1000h through 4000h. The default value is 4000h.

L=minXMS

Ensures that the specified amount (in kilobytes) of extended memory will still be available after EMM386 is loaded. The default value is 0.

a=altregs

Specifies how many fast alternate register sets (used for multitasking) you want to allocate to EMM386. Valid values are in the range 0 through 254. The default value is 7. Every alternate register set adds about 200 bytes to the size in memory of EMM386.

h=handles

Specifies how many handles EMM386 can use. Valid values are in the range 2 through 255. The default value is 64.

d=nnn

Specifies how many kilobytes of memory should be reserved for buffered DMA. Discounting floppy-disk DMA, this value should reflect the largest DMA transfer that will occur while EMM386 is active. Valid values for *nnn* are in the range 16 through 256. The default value is 16.

ram=mmmm-nnnn

Specifies a range of segment addresses to be used for UMBs and also enables EMS support. If you do not specify a range, EMM386 uses all available adapter space to create UMBs and a page frame for EMS.

noems

Provides access to the upper memory area but prevents access to expanded memory.

novcpi

Disables support for VCPI applications. This switch must be used with the **noems** switch. If you

specify the **novcpi** switch without specifying the **noems** switch, EMM386 does not disable VCPI support. If you specify both switches, EMM386 disregards the *memory* parameter and the **min** switch. Disabling support for VCPI applications reduces the amount of extended memory allocated.

highscan

Specifies that EMM386 use an additional check to determine the availability of upper memory for use as UMBs or EMS windows. On some computers, specifying this switch may have no effect or cause EMM386 to identify upper memory areas as available when they are not. As a result, the computer might stop responding.

verbose

Directs EMM386 to display status and error messages while loading. By default, EMM386 displays messages only if it encounters an error condition. You can abbreviate **verbose** as **V**. (To display status messages without adding the **verbose** switch, press and hold ALT while EMM386 starts and loads.)

win=mmmm-nnnn

Reserves a specified range of segment addresses for Windows instead of for EMM386. Valid values for *mmmm* and *nnnn* are in the range A000h through FFFFh and are rounded down to the nearest 4-kilobyte boundary. The **x** switch takes precedence over the **win** switch if the two ranges overlap. The **win** switch takes precedence over the **ram**, **rom**, and **i** switches if their ranges overlap.

nohi

Prevents EMM386 from loading into the upper memory area. Normally, a portion of EMM386 is loaded into upper memory. Specifying this switch decreases available conventional memory and increases the upper memory area available for UMBs.

rom=mmmm-nnnn

Specifies a range of segment addresses that EMM386 uses for shadow RAM — random-access memory used for read-only memory (ROM). Valid values for *mmmm* and *nnnn* are in the range A000h through FFFFh and are rounded down to the nearest 4-kilobyte boundary. Specifying this switch may speed up the system if it does not already have shadow RAM.

nomovexbda

Prevents EMM386 from moving the extended BIOS data from conventional memory to upper memory.

altboot

Specifies that EMM386 use an alternate handler to restart the computer when you press CTRL+ALT+DEL. Use this switch only if the computer stops responding or exhibits other unusual behavior when EMM386 is loaded and you press CTRL+ALT+DEL.

Notes on EMM386.EXE

Must install HIMEM.SYS before EMM386.EXE.

You must include a **device** command for the HIMEM.SYS device driver in CONFIG.SYS before the **device** command for EMM386.EXE.

Using EMM386 memory switches.

Unless you want to use EMM386 to provide access to the upper memory area, you need not specify memory switches on the **device** command line. EMM386 usually runs properly with the default values. In some cases, however, you might want to control how EMM386 uses memory. For example, you can control where EMM386 puts the EMS page frame or which segments it uses for EMS pages. You can use as many of these memory switches as you want, in any order you want.

Using EMM386 to provide access to the upper memory area.

In addition to providing access to expanded memory, EMM386 provides access to the upper memory area, which you can use to load certain programs and device drivers. You must use either the **ram** or **noems** switch to provide access to the upper memory area.

To give the operating system access to the upper memory area but not to expanded memory, use the **noems** switch. To give the operating system access to both the upper memory area and expanded memory, use the **ram** switch. The **ram** switch provides access to less of the upper memory area for running device drivers and programs than does the **noems** switch. In either case, you must include the **dos=umb** command in CONFIG.SYS. The **device** command for EMM386.EXE must precede any

devicehigh commands.

EMM386.EXE Examples

To start EMM386 as an expanded-memory emulator, using the default values, add the following lines to CONFIG.SYS:

```
device=himem.sys  
device=emm386.exe
```

Because no location is specified, MS-DOS searches for the EMM386.EXE file in the root directory of the startup drive.

To specify that EMM386 allocate a maximum of 4096K of memory and a guaranteed 256K of memory (the default value), and to specify that the EMM386.EXE file is located in the DOS directory on drive C, add the following line to CONFIG.SYS:

```
device=c:\dos\emm386.exe 4096
```

To emulate expanded memory, specify the segment-base address D000h for the EMS page frame, and allocate 512K of memory to EMM386, use one of the following commands:

```
device=emm386.exe 512 frame=d000
```

```
device=emm386.exe 512 p0=d000 p1=d400 p2=d800 p3=dc00
```

Suppose that, in addition to specifying the conditions set in the preceding commands, you want to prevent EMM386 from using the segment addresses E000h through EC00h. To do this and to specify that EMM386 can use 127 handles, add the following line to CONFIG.SYS:

```
device=emm386.exe 512 frame=d000 x=e000-ec00 h=127
```

To provide access to the upper memory area but not provide EMS/VCPI memory, add the following line to CONFIG.SYS:

```
device=emm386.exe noems novcpi
```

To provide access to the upper memory area and provide EMS/VCPI memory, add the following line to CONFIG.SYS:

```
device=emm386.exe ram
```

Windows Explorer Command-Line Switches

You can use the command-line switches for Windows Explorer in shortcut links or batch files, for example, to run Windows Explorer with a specified file selected.

Syntax

```
explorer [/n] [/e][,/root,object][,/select],subobject
```

Parameters

/n

Always open a new window (even if the specified folder is already open).

/e

Use Windows Explorer view. The default is Open view.

/root,object

Specify the object in the normal namespace that will be used as the root of this Windows Explorer Folder. The default is to just use the normal namespace root (the desktop).

subobject

Specify the folder to receive the initial focus unless **/select** is used. The default is the root.

/select

Specifies that the parent folder is opened and the specified object is selected.

Windows Explorer Examples

To open a window rooted at \\myserver so you can easily browse the whole server, but nothing else:

```
explorer /e,/root,\\myserver
```

To open a folder window on C:\WINDOWS (or make an open window active) and select CALC.EXE, use:

```
explorer /select,c:\windows\calc.exe
```

Xcopy Command-Line Switches

This command is used to copy files and directories, including subdirectories.

Syntax

```
xcopy source [destination] [/w] [/p] [/c] [/v] [/q] [/f] [/l] [/d[:date]] [/u] [/i]
  [/s] [/e] [/t] [/k] [/r] [/h] [/a|m] [/n] [/exclude:filename]
```

Parameters

source

Specifies the location and names of the files you want to copy. *Source* must include either a drive or a path.

destination

Specifies the destination of the files you want to copy. *Destination* can include a drive letter and colon, a directory name, a filename, or a combination.

/w

Displays a message asking you to press a key to begin copying files, and waits for your response before starting to copy files.

/p

Prompts you to confirm whether you want to create each destination file.

/c

Ignores errors.

/v

Verifies each file as it is written to the destination file to make sure that the destination files are identical to the source files. This switch is ignored because the functionality is inherent to the Windows 95 operating system. The switch is accepted only for compatibility with previous versions of MS-DOS.

/q

Suppresses display of **xcopy** messages.

/f

Displays source and destination filenames while copying.

/l

Does not copy files, only displays (lists) files that would be copied.

/d[:*date*]

Copies only source files changed on or after the specified date. If the *date* value is missing, **xcopy** copies all *source* files that are newer than the time of existing *destination* files. This option allows you to update only files that have changed. Notice that dates in the twenty-first century must be specified using four digits (for example, /D:1-1-2001 if *m-d-y* is the date format). That is, /D:1-1-01 is interpreted as 1 January 1901 rather than 1 January 2001.

/u

Copies (updates) only files from *source* that exist on *destination*.

/i

If *source* is a directory or contains wildcards, and *destination* does not exist, **xcopy** assumes *destination* specifies a directory name and creates a new directory and then copies all specified files into the new directory. By default, **xcopy** prompts you to specify whether *destination* is a file or directory.

/s

Copies directories and subdirectories, unless they are empty. If you omit this switch, **xcopy** works within a single directory.

/e

Copies all subdirectories, even if they are empty. Used with the */s* and */t* switches.

/t

Copies only subdirectory structure (tree), not files. To copy empty directories, you must include the **/e** switch.

/k

Copies files and retains the read-only attribute on destination files if present on the source files. By default, the read-only attribute is removed.

/r

Copies over read-only files.

/h

Copies files with the hidden and system file attributes. **Xcopy** will not copy hidden or system files by default.

/a

Copies only source files that have their archive file attributes set. This switch does not modify the archive file attribute of the source file. For information about how to set the archive file attribute, see the online Help for the **attrib** command.

/m

Copies source files that have their archive file attributes set. Unlike the **/a** switch, the **/m** switch turns off archive file attributes in the files specified in source. For information about how to set the archive file attributes, see the online Help for the **attrib** command.

/n

Copies using aliases (short file or directory names). This switch is required when copying files or directories from a VFAT volume to a FAT volume or when the 8.3 file naming convention is required on the destination volume.

/exclude:filename

Excludes the files listed in the specified file from the copy operation. The exclusion file can have a list of exclusion patterns (one per line, no wild card characters are supported). If any exclusion pattern in the file matches any part of the path of a subject file, that file is not copied.

Notes on Xcopy

Default value for destination.

If you omit *destination*, the **xcopy** command copies the files to the current directory.

Specifying whether the destination is a file or a directory.

If *destination* does not contain an existing directory and does not end with a backslash (\), **xcopy** prompts you with a message in the following format:

```
Does destination specify a file name
or directory name on the target
(F = file, D = directory)?
```

You can avoid this prompt by using the **/i** switch, in which case **xcopy** assumes the destination is a directory if the source is more than one file or a directory.

Xcopy sets an archive attribute for destination files.

Xcopy creates files with the archive attribute set, whether or not this attribute was set in the source file. For information, see the online Help for **attrib** command.

Xcopy vs. diskcopy.

If you have a disk that contains files in subdirectories and you want to copy it to a disk that has a different format, you should use the **xcopy** command instead of **diskcopy**. The **diskcopy** command copies disks track by track; it requires that your source and destination disks have the same format. **Xcopy** has no such requirement. In general, use **xcopy** unless you need a complete disk image copy.

Xcopy exit codes.

The following list shows each exit code and a brief description of its meaning:

- 0 Files were copied without error.
- 1 No files were found to copy.

- 2 The user pressed CTRL+C to terminate **xcopy**.
- 4 Initialization error occurred. There is not enough memory or disk space, or you entered an invalid drive name or invalid syntax on the command line.
- 5 Disk write error occurred.

You can use the **errorlevel** parameter on the **if** command line in a batch program to process exit codes returned by **xcopy**.

Xcopy Examples

To copy all the files and subdirectories (including any empty subdirectories) from the disk in drive A to the disk in drive B, type:

```
xcopy a: b: /s /e
```

To include any system or hidden files in the previous example, add the **/h** switch when typing:

```
xcopy a: b: /s /e /h
```

To update files in the REPORTS directory with the files in the directory RAWDATA that have changed since December 29, 1993, type:

```
xcopy \rawdata \reports /d:12/29/93
```

To update all the files that exist on \REPORTS in the previous example, regardless of date, type:

```
xcopy \rawdata \reports /u
```

To obtain only a list of the files that would be copied for the previous command, without copying the files, type:

```
xcopy \rawdata \reports /d:12/29/93 /l > xcopy.out
```

The file XCOPY.OUT lists every file that would be copied.

To copy the \CUSTOMER directory and all subdirectories, including empty directories, to the directory \PUBLIC\ADDRESS on network drive H and retain the read-only attribute, while being prompted when a new file is being created on H, type the following:

```
xcopy \customer h:\public\address /s /e /k /p
```

To issue the previous command and ensure **xcopy** creates, without prompting, the directory \ADDRESS if it does not exist, add the **/i** switch:

```
xcopy \customer h:\public\address /s /e /k /p /i
```

You can create a batch program to perform **xcopy** operations and use the batch **if** command to process the exit code in case an error occurs. For example, the following batch program uses replaceable parameters for the **xcopy** *source* and *destination* parameters:

```
@echo off
rem COPYIT.BAT transfers all files in all subdirectories of
rem the source drive or directory (%1) to the destination
```

```
rem drive or directory (%2)
xcopy %1 %2 /s /e
if errorlevel 4 goto lowmemory
if errorlevel 2 goto abort
if errorlevel 0 goto exit
:lowmemory
echo Insufficient memory to copy files or
echo invalid drive or command-line syntax.
goto exit
:abort
echo You pressed CTRL+C to end the copy operation.
goto exit
:exit
```

To use this batch program to copy all files in the C:\PRGMCODE directory and its subdirectories to drive B, type the following command:

```
copyit c:\prgmcode b:
```

The command interpreter substitutes C:\PRGMCODE for **%1** and B: for **%2**, then uses **xcopy** with the **/e** and **/s** switches. If **xcopy** encounters an error, the batch program reads the exit code and goes to the label indicated in the appropriate **if errorlevel** statement. Windows 95 displays the appropriate message and exits from the batch program.

Command-Line Switches for Disk Utilities

This section describes the commands that can be used from the command line to run the Windows-based versions of the ScanDisk, DriveSpace, and Disk Defragmenter disk utilities. These commands are provided to allow these disk utilities to be run from batch files.

Note To provide compatibility with existing batch files, Windows 95 provides a **start** command to allow synchronous use of Windows-based programs from the command-line. To run a Windows-based program from the command-line and wait for it, use this syntax:

start /W "*program_name arguments*"

Defrag

This command controls Windows 95 Disk Defragmenter. For more information about this utility, see [Disks and File Systems](#).

Syntax

defrag [*drive:* | **/all**] [**/F** | **/U** | **/Q**] [**/noprompt**] [**/concise** | **/detailed**]

Parameters

drive:

Drive letter of the disk to be optimized.

/all

Defragment all local, nonremovable drives.

/F

Defragment files and free space.

/U

Defragment files only.

/Q

Defragment free space only.

/concise

Display the Hide Details view (default).

/detailed

Display the Show Details view.

/noprompt

Unattended mode; do not stop and display confirmation messages.

DrvSpace

This command controls Windows DriveSpace at the command line, and can be used with either DbIspace or DrvSpace drives. These command switches are maintained for use in batch files and for compatibility with the compression utilities provided in MS-DOS version 6 and higher. Each switch performs the indicated operation, without asking for any additional input before beginning.

Additionally, the **/interactive** switch can be added to any command line to have DriveSpace ask for any missing parameters, and the **/noprompt** switch can be added to any syntax except the **/info** and **/settings** command-lines. The **/noprompt** switch prevents any confirmation dialog boxes from appearing (except for error messages). Notice that there is no way to prevent error messages from being displayed.

When you run DriveSpace without command-line arguments, the DriveSpace Manager appears, with menu commands for selecting the operations to perform. For more information about this utility, see [Disks and File Systems](#).

Syntax

```
drvspace /compress d: [/size=n] /reserve=n] [/new=e:]  
drvspace /create d: [/size=n | /reserve=n] [/new=e:] [/cvf=nnn]  
drvspace /delete d:\d??space.nnn  
drvspace /format d:\d??space.nnn  
drvspace /host=e: d:  
drvspace [/info] d:  
drvspace /mount {[=nnn] d: | d:\d??space.nnn} [/new=e:]  
drvspace /move d: /new=e:  
drvspace /ratio[=n] d:  
drvspace /settings  
drvspace /size[=n] /reserve=n] d:  
drvspace /uncompress d:  
drvspace /unmount d:
```

Parameters

d??space.*nnn*

The filename of the hidden compressed volume file on the host drive, which can be either DRVSPACE.*nnn* or DBLSPACE.*nnn*, where *nnn* represents the actual filename extension.

The following sections provide details for these parameters.

If you add switches or parameters to the **drvspace** command, the operating system carries out the requested task without starting the DriveSpace program. The command syntax differs from task to task, as summarized in the following list.

Action

Compress a hard disk drive or floppy disk.

Create a new compressed drive in the free space on an existing drive.

Delete a compressed drive.

Format a compressed drive.

Display information about a compressed drive.

Mount a compressed volume file (CVF). When DriveSpace mounts a CVF, it assigns it a drive letter; you can then use the files that CVF contains.

Change estimated compression ratio of a compressed drive.

Change the size of a compressed drive.

Command

drvspace /compress

drvspace /create

drvspace /delete

drvspace /format

drvspace /info

drvspace /mount

drvspace /ratio

drvspace /size

Uncompress a compressed drive.

drvspace /uncompress

Unmount a compressed drive.

drvspace /unmount

Notes on Drvspace

Fixing problems with drives compressed using DriveSpace.

DriveSpace no longer provides a Chkdsk command as in earlier versions. Instead, Windows 95 includes the new ScanDisk program, a full-featured disk analysis and repair utility. ScanDisk can check and repair both uncompressed drives and DriveSpace or DoubleSpace drives. It can even check and repair unmounted DriveSpace or DoubleSpace compressed volume files. For more information, see [ScanDisk](#).

DBLSPACE.BIN, DRVSPACE.BIN, and DRVSPACE.SYS.

DBLSPACE.BIN or DRVSPACE.BIN is the part of the system that provides access to the compressed drives. When you start the computer, the operating system loads D??SPACE.BIN along with other operating system functions, before carrying out the commands in CONFIG.SYS and AUTOEXEC.BAT. D??SPACE.BIN initially loads in conventional memory, since it loads before device drivers that provide access to upper memory. Normally, if the hard disk drive has been compressed using DriveSpace, D??SPACE.BIN is loaded even if you press F8 and choose an alternate startup option.

DRVSPACX.VXD is the protected-mode driver for DriveSpace. This driver takes over from the real-mode D??SPACE.BIN driver when Windows 95 switches to protected mode. The real-mode driver is required for starting the computer, but after the system switches to protected mode, DRVSPACX ensures that you have 32-bit, protected-mode performance, and the memory used by the real-mode driver is reclaimed.

The DBLSPACE.SYS device driver does not provide access to compressed drives; instead it determines the final location of D??SPACE.BIN in memory. When loaded with a **device** command, the DBLSPACE.SYS device driver moves D??SPACE.BIN from the top to the bottom of conventional memory. When loaded with a **devicehigh** command, DBLSPACE.SYS moves D??SPACE.BIN from conventional to upper memory, if available. Whenever possible, DBLSPACE.SYS moves a portion of D??SPACE.BIN into the HMA.

How DriveSpace assigns drive letters.

When you compress a drive using DriveSpace, it creates a new drive and assigns a drive letter to that drive. DriveSpace skips the first four available drive letters and assigns the next available drive letter to the new drive. For example, if the computer has only drives A, B, and C, DriveSpace skips letters D, E, F, and G, and assigns drive letter H to the new drive.

When assigning letters to additional drives (for example, if you compress another drive), DriveSpace works backwards from the first drive letter it assigned. In the example above, DriveSpace would next assign the letter G.

DriveSpace attempts to avoid drive-letter conflicts with drives created by **fdisk**, RAMDrive, networks, or other installable device drivers that assign drive letters. However, if a drive-letter conflict does occur, DriveSpace resolves the conflict by reassigning its drive letters.

Drvspace /Compress

Compresses the files and free space on an existing hard disk drive, floppy disk, or other removable media. Compressing an existing drive makes more space available on that drive.

Note DriveSpace cannot compress a drive that's completely full. To compress the startup hard disk drive, the drive must contain at least 2 MB of free space. Other hard disk drives and floppy disks must contain at least 768K of free space. (DriveSpace cannot compress 360K floppy disks.)

Syntax

drvspace /compress *drive1*: [*/new=drive2*:] [*/reserve=size*]

Parameters

drive1:

Specifies the existing drive you want to compress.

Switches

/compress

Compresses the hard disk drive or floppy disk specified by the drive parameter. This switch can be abbreviated to ***/com***.

/new=drive2:

Specifies the drive letter for the uncompressed (host) drive. After DriveSpace compresses an existing drive, the system will include both the existing drive (now compressed) and a new uncompressed drive. If you omit the ***/new*** switch, DriveSpace assigns the next available drive letter to the new drive.

/reserve=size

Specifies how many megabytes of space to leave uncompressed. Because some files do not work properly when stored on a compressed drive, you may want to reserve some uncompressed space. The uncompressed space will be located on the new uncompressed drive. This switch can be abbreviated to ***/reser***.

Drvspace /Compress Examples

To compress drive D, type the following command:

```
drvspace /compress d:
```

On drives larger than 256 MB, more space will be left on the host (because DriveSpace drives cannot be larger than 512 MB). Because this command does not specify how much space to leave uncompressed, DriveSpace leaves 2 MB of uncompressed space (the default). Because the command does not specify a drive letter for the uncompressed drive, DriveSpace assigns the next available drive letter to the new uncompressed drive (the host drive).

To direct DriveSpace to compress drive E, assign the drive letter F to the new uncompressed drive (the host drive), and leave 4 MB of uncompressed space on drive F, type the following command:

```
drvspace /compress e: /new=f: /reserve=4
```

Drvspace /Create

Creates a new compressed drive by using free space on an uncompressed drive. The new compressed drive will provide more storage capacity than the amount of space it uses.

Syntax

```
drvspace /create drive1: [/new=drive2:] [/size=size | /reserve=size] [/cvf=nnn]
```

Parameters

drive1:

Specifies the uncompressed drive that contains the space you want to use to create the new drive.

Switches

/create

Creates a new compressed drive by using free space on the uncompressed drive specified by *drive1*. This switch can be abbreviated to **/cr**.

/new=drive2:

Specifies the drive letter for the new compressed drive. The **/new** switch is optional; if you omit it, DriveSpace assigns the next available drive letter to the new drive.

/reserve=size

Specifies how many megabytes of free space DriveSpace should leave on the uncompressed drive. To make the compressed drive as large as possible, specify a size of 0.

You can include either the **/reserve** switch or the **/size** switch, but not both. If you omit both switches, DriveSpace uses all but 2 MB of free space. The **/reserve** switch can be abbreviated as **/reser**.

/size=size

Specifies the total size, in megabytes, of the compressed volume file. (This is the amount of space on the uncompressed drive that you want to allocate to the compressed drive.) You can include either the **/reserve** switch or the **/size** switch, but not both.

/cvf=nnn

Reports extension of the CVF file.

Drvspace /Create Examples

To create a new compressed drive that uses all available space on uncompressed drive E, type the following command:

```
drvspace /create e: /reserve=0
```

To create a new compressed drive by using 10 MB of space on uncompressed drive E, type the following command:

```
drvspace /create e: /size=10
```

To create a new compressed drive by using space on uncompressed drive D, and to direct DriveSpace to leave 2.75 MB of free space on drive D, type the following command:

```
drvspace /create d: /reserve=2.75
```

The following command creates a new compressed drive by using all but 2 MB of the space on drive D:

```
drvspace /create d:
```

Because the command includes neither the **/reserve** switch nor the **/size** switch, DriveSpace uses the default value for the **/reserve** switch and leaves 2 MB of space on drive D.

Command-Line Commands Summary
Command-Line Switches for Disk Utilities
DrvSpace

Drvspace /Delete

Deletes the selected compressed drive and erases the associated compressed volume file.

Caution Deleting a compressed drive erases the entire drive and all the files it contains.

Syntax

drvspace /delete d:\d??space.###

Parameters

d:\d??space.###

Specifies the drive you want to delete. (DriveSpace will not allow you to delete any drive containing open files, including the drive containing Windows 95.)

Switch

/delete

Deletes the specified drive. This switch can be abbreviated as **/del**.

Drvspace /Delete Example

The following command directs DriveSpace to delete the compressed volume for drive C:

```
drvspace /delete h:\dblspace.###
```

DriveSpace then deletes the compressed volume file for drive C. This completely erases the compressed drive and all the files it contains.

Command-Line Commands Summary
Command-Line Switches for Disk Utilities
DrvSpace

Drvspace /Format

Formats the selected compressed drive.

Caution Formatting a compressed drive deletes all the files it contains. You cannot unformat a drive that has been formatted by using **drvspace /format**.

Syntax

drvspace /format d:\d??space.###

Parameters

d:\d??space.###

Specifies the drive you want to format. (DriveSpace will not allow you to format any drive containing open files, including the drive containing Windows 95.)

Switch

/format

Directs DriveSpace to format the specified compressed drive. This switch can be abbreviated as **/f**.

Drvspace /Format Example

The following command directs DriveSpace to format compressed drive E:

```
drvspace /format h:\dblspace.###
```

DriveSpace then formats compressed drive E, which completely erases all the files on it.

Command-Line Commands Summary
Command-Line Switches for Disk Utilities
DrvSpace

Drvspace /Info

Displays information about the selected drive's free and used space, the name of its compressed volume file, and its actual and estimated compression ratios. You can use this command while Windows is running.

Syntax

drvspace [/info] | [drive:]

Parameters

drive:

Specifies the compressed drive about which you want information. If you don't specify a drive letter, DriveSpace displays information about the current drive.

Switch

/info

Directs DriveSpace to display information about the selected drive. This switch is optional and can be omitted as long as you specify a drive letter.

Drvspace /Info Examples

The following command displays information about the current drive:

```
drvspace /info
```

The following command displays information about drive C:

```
drvspace /info c:
```

The following command displays information about drive E:

```
drvspace e:
```

Drvspace /Mount

Establishes a connection between a compressed volume file (CVF) and a drive letter so that you can use the files the CVF contains. DriveSpace usually mounts CVFs automatically. You need to mount a CVF only if you previously unmounted it.

Syntax

```
drvspace /mount[=nnn] drive1: [/new=drive2:]  
drvspace /mount d:\d??space.### [/new=drive2:]
```

Parameters

drive1:

Specifies the drive that contains the compressed volume file you want to mount. You must specify a drive letter.

Switches

/mount=*nnn*

Directs DriveSpace to mount the compressed volume file with the filename extension specified by the *nnn* parameter. For example, to mount a CVF named DBLSPACE.001, you would specify **/mount=001**. If you omit the *nnn* parameter, DriveSpace attempts to mount the compressed volume file named DBLSPACE.000.

/new=*drive2*:

Specifies the drive letter to assign to the new drive. This switch is optional; if you don't specify a drive letter, DriveSpace assigns the new drive the next available drive letter.

Drvspace /Mount Examples

To mount a compressed floppy disk in drive A, type the following:

```
drvspace /mount a:
```

To mount the compressed volume file DBLSPACE.001 located on uncompressed drive D, type the following:

```
drvspace /mount=001 d:
```

Drvspace /Ratio

Changes the estimated compression ratio of the selected drive. DriveSpace uses this ratio to estimate how much free space the drive contains. You might want to change the estimated compression ratio if you plan to store new files with a compression ratio that differs greatly from the current ratio.

Syntax

drvspace /ratio[=*r.r*] [*drive*:]

Parameters

drive:

Specifies the drive for which you want to change the estimated compression ratio. If you do not specify a drive, DriveSpace changes the estimated compression ratio for the current drive.

Switch

/ratio=*r.r*

Changes the estimated compression ratio of the specified drive. To change the ratio to a specific number, specify the ratio you want. You can specify a ratio from 1.0 to 16.0. However, not all drives can accept values in this entire range. If you don't specify a ratio, DriveSpace sets the drive's estimated compression ratio to the average actual compression ratio for all the files currently on the drive. This switch can be abbreviated as **/ra**.

Drvspace /Ratio Examples

To change the estimated compression ratio of the current drive to match that drive's actual compression ratio, type the following command:

```
drvspace /ratio
```

To change the estimated compression ratio for drive D so that it is 3.2 to 1, type the following:

```
drvspace /ratio=3.2 d:
```

To change the estimated compression ratio of the current drive to 6 to 1, type the following:

```
drvspace /ratio=6
```

Drvspace /Size

Enlarges or reduces the size of a compressed drive. You might want to enlarge a compressed drive if its host drive contains plenty of free space. You might want to reduce its size if you need more free space on the host drive.

Syntax

drvspace /size[=*size1* | /reserve=*size2*] drive:

Parameters

drive:

Specifies the drive you want to resize.

Switches

/size=*size1*

Changes the size of the specified drive. You can specify the new size of the drive by using the *size1* parameter. The size of the drive is the number of megabytes of space that the drive's compressed volume file uses on the uncompressed (host) drive.

You can specify the drive's new size by using either the *size1* parameter or the **/reserve** switch, but not both. If you include neither the *size1* parameter nor the **/reserve** switch, DriveSpace makes the drive as small as possible.

/reserve=*size2*

Specifies how many megabytes of free space you want the uncompressed (host) drive to contain after DriveSpace resizes the drive. The **/reserve** switch can be abbreviated as **/reser**.

You can specify the drive's new size by using either the **/reserve** switch or the *size1* parameter of the **/size** switch, but not both. If you include neither the **/reserve** switch nor the *size1* parameter, DriveSpace makes the drive as small as possible.

Drvspace /Size Examples

To change the size of drive C so that its compressed volume file uses 60.5 MB of space on drive D, type the following command:

```
drvspace /size=60.5 c:
```

To change the size of drive E so that its host drive, drive D, contains 20 MB of free uncompressed space, type the following command:

```
drvspace /size /reserve=20 e:
```

To change the size of drive C so that it is as large as possible, type the following command:

```
drvspace /size /reserve=0 c:
```

Drvspace /Uncompress

Uncompresses a drive that was compressed by using DriveSpace.

Syntax

drvspace /uncompress *drive*:

Parameter

drive:

Specifies the drive you want to uncompress.

Switch

/uncompress

Uncompresses the specified drive.

Notes on Drvspace /Uncompress

Backing up before uncompressing.

Before uncompressing the drive, you should back up the files it contains. If you include the **/interactive** switch, DriveSpace will prompt for this.

Invalid pathnames after uncompressing.

When you uncompress a drive, DriveSpace either changes that drive's letter or the letter of its host drive (depending on how the compressed drive was originally created). DriveSpace shows how the drive letters will change when it uncompresses the drive. Some programs have settings that include explicit pathnames and drive letters. If a program's settings specify a drive that is no longer valid after uncompressing, the program will probably display an error message or be unable to find one of its components or data files. In that case, you need to correct the drive letter specified by that setting.

Disk space.

You can uncompress a drive only if the data it contains will fit on the host drive. If you use the **drvspace /uncompress** command, and DriveSpace indicates the drive will not have enough free disk space, delete unnecessary files or move them to another drive.

Duplicate filenames on compressed and host drives.

If the root directories of the compressed and host drives contain files or directories with identical names, DriveSpace cannot uncompress the compressed drive. If this happens, DriveSpace displays an error message. Remove or rename one copy of each file, and then try uncompressing the drive again.

Uninstalling DriveSpace.

When you uncompress the last mounted compressed drive, DriveSpace first uncompresses the drive, and then prompts you to remove the DrvSpace driver from memory.

Drvspace /Uncompress Example

To uncompress drive E, type the following command:

```
drvspace /uncompress e:
```

Command-Line Commands Summary

Command-Line Switches for Disk Utilities

DrvSpace

Drvspace /Unmount

Breaks the connection between the selected drive's compressed volume file and its drive letter. Unmounting a drive makes it temporarily unavailable.

You cannot unmount a drive containing open files, including the drive containing Windows 95.

Syntax

drvspace /unmount [*drive:*]

Parameters

drive:

Specifies the drive you want to unmount. This parameter is optional; if you omit it, DriveSpace unmounts the current drive.

Switch

/unmount

Unmounts the specified compressed drive.

Drvspace /Unmount Example

To unmount compressed drive E, type the following command:

```
drvspace /unmount e:
```

ScanDisk

This command syntax controls Windows ScanDisk. For more information about this utility, see [Disks and File Systems](#).

Note At the command prompt (for example, when you use F8 to start only the command prompt), you can use **scandisk** with the same switches to run the MS-DOS-based equivalent for this command. At the command prompt, type **scandisk /?** for more information.

Syntax

```
scandiskw [drive:] [/A] [/N] [/P]  
scandisk drive:\dblspace.nnn  
scandisk drive:\drvspace.nnn
```

Parameters

drive:

Specifies one or more drives to be checked.

/A or **/All**

Checks all local, nonremovable hard disk drives.

/N or **/NonInteractive**

Starts and closes ScanDisk automatically. However, this switch does not prevent ScanDisk from stopping to report errors found on the drive.

/p or **/Preview**

Runs ScanDisk in Preview mode, where it reports and seems to correct errors that it finds, but it does not actually write changes to the disk.

Important When running **scandiskw** in Preview mode, it appears as though ScanDisk is fixing errors, but it is not. Also, notice that unlike other settings in ScanDisk, the **/Preview** switch is not saved in the Registry, so the next time you run ScanDisk, it is no longer in Preview mode.

To determine whether ScanDisk is running in Preview mode, look for the tag "(Preview)" in the caption of the main ScanDisk window.

dblspace.nnn or **drvspace.nnn**

Checks the specified unmounted DoubleSpace or DriveSpace compressed volume file, where *nnn* is the filename extension for the hidden host file.

The following table describes the codes provided when ScanDisk finished running.

Exit code	Description
0x00	Drive checked, no errors found
0x01	Errors found, all fixed
0xFA	Check could not start — cannot load or find DSKMAINT.DLL
0xFB	Check could not start — insufficient memory
0xFC	Errors found, but at least some were not fixed
0xFD	At least one drive could not be checked
0xFE	Check was canceled
0xFF	Check was terminated because of an error

You can capture the exit code in a batch file to define an action to take in the event of particular exit code. For example:

```
start /w scandiskw c: d: /n  
if errorlevel exitcode goto command  
...
```

In this sample, **start /w** forces the batch file to stop and wait for **scandskw** to finish (otherwise, because it is a Windows-based program, the batch file would continue as soon as **scandskw** had been launched). Also in this example, if the actual exit code is greater than or equal to the exit code specified by *exitcode*, the batch file runs the specified *command*; otherwise, it continues to the next line in the batch file. The **goto command** entry could specify any command you want.

TCP/IP Utilities

The TCP/IP utilities offer network connections to non-Microsoft hosts such as UNIX® system computers. You must have the TCP/IP network protocol installed to use the TCP/IP utilities. These tools are installed automatically when you install Microsoft TCP/IP.

Command	Purpose
arp	Displays and modifies the IP-to-Ethernet address translation tables.
ftp	Transfers files to and from a node running ftp service; similar to tftp .
nbtstat	Displays protocol statistics and current TCP/IP connections using NetBIOS over TCP/IP.
netstat	Displays protocol statistics and current TCP/IP connections.
ping	Verifies connections to a remote host or hosts.
route	Manually controls network routing tables.
tracert	Determines the route taken to a destination.

Note Switches used in the syntax for all TCP/IP utilities are case-sensitive. For example, for the **nbtstat** command, the switch **-R** has a different effect from the **-r** switch.



To get help on TCP/IP utilities

- At the command prompt, type **-?** followed by a space and the command name. For example, type **ping -?** to get help on the **ping** command.

Important The FTP and Telnet utilities rely on password authentication by the remote computer. Passwords are not encrypted before being sent over the network. This allows another user equipped with a network analyzer on the same network to steal a user's remote account password. For this reason, it is strongly recommended that users of these utilities choose different passwords for their workgroup, computer, or domain from the passwords used when connecting to computers that are not on Microsoft networks.

The following presents a complete reference for the TCP/IP commands included with Windows 95.

Arp

This diagnostic command displays and modifies the IP-to-Ethernet or IP-to-token ring address translation tables used by the address resolution protocol (ARP).

Syntax

```
arp -a [inet_addr] [-N [if_addr]]  
arp -d inet_addr [if_addr]  
arp -s inet_addr ether_addr [if_addr]
```

Parameters

-a

Displays current ARP entries by querying TCP/IP. If *inet_addr* is specified, only the IP and physical addresses for the specified computer are displayed.

-d

Deletes the entry from the ARP cache table that is specified by *inet_addr*.

-s

Adds an entry in the ARP cache to associate the IP address *inet_addr* with the physical address *ether_addr*. The physical address is given as 6 hexadecimal bytes separated by hyphens. The IP address is specified using dotted decimal notation. The entry is permanent, that is, it will not be automatically removed from the cache after the timeout expires.

-N [*if_addr*]

Displays the ARP entries for the network interface specified by *if_addr*.

ether_addr

Specifies a physical address.

if_addr

Specifies, if present, the IP address of the interface for which the address translation table should be modified. If not present, the first applicable interface will be used.

inet_addr

Specifies an IP address in dotted decimal notation.

Ftp

This connectivity command transfers files to and from a computer running an FTP service. The **ftp** command can be used interactively or by processing ASCII text files.

Syntax

ftp [-v] [-n] [-i] [-d] [-g] [*host*] [-s: *filename*]

Parameters

-v

Suppresses display of remote server responses.

-n

Suppresses autologon upon initial connection.

-i

Turns off interactive prompting during multiple file transfers.

-d

Enables debugging, displaying all FTP commands passed between the client and server.

-g

Disables filename globbing, which permits the use of wildcard characters in local file and path names. (See the FTP **glob** command.)

host

Specifies the host name or IP address of the remote host to connect to.

-s: filename

Specifies a text file containing FTP commands; the commands will automatically run after **ftp** starts. Use this switch instead of redirection (>).



To use the ftp command

- At the command prompt, type **ftp** plus any desired switches and press ENTER.
For example, you might type **ftp -s:myfile.scr**

The following table shows the FTP commands available when Microsoft TCP/IP is installed on a computer.

FTP Commands in Microsoft TCP/IP

Command	Purpose
!	Runs the specified command on the local computer.
?	Displays descriptions for ftp commands. Identical to help .
append	Appends a local file to a file on the remote computer, using the current file type setting.
ascii	Sets the file transfer type to ASCII, the default.
bell	Toggles a bell to ring after each file transfer command is completed. By default, the bell is off.
binary	Sets the file transfer type to binary.
bye	Ends the FTP session with the remote computer and exits ftp .
cd	Changes the working directory on the remote computer.
close	Ends the FTP session with the remote server and returns to the command interpreter.
debug	Toggles debugging. When debugging is on, each command sent to the remote computer is printed, preceded by the string --->. By default, debugging is off.

delete	Deletes files on remote computers.
dir	Displays a list of a remote directory's files and subdirectories.
disconnect	Disconnects from the remote computer, retaining the ftp prompt.
get	Copies a remote file to the local computer, using the current file transfer type.
glob	Toggles filename globbing. Globbing permits use of wildcard characters in local file or path names. By default, globbing is on.
hash	Toggles hash-mark (#) printing for each 2048 bytes data block transferred. By default, hash-mark printing is off.
help	Displays descriptions for FTP commands.
lcd	Changes the working directory on the local computer. By default, the current directory on the local computer is used.
literal	Sends arguments, verbatim, to the remote FTP server. A single FTP reply code is expected in return.
ls	Displays an abbreviated list of a remote directory's files and subdirectories.
mdelete	Deletes multiple files on remote computers.
mdir	Displays a list of a remote directory's files and subdirectories. Allows you to specify multiple files.
mget	Copies multiple remote files to the local computer using the current file transfer type.
mkdir	Creates a remote directory.
mls	Displays an abbreviated list of a remote directory's files and subdirectories.
mput	Copies multiple local files to the remote computer, using the current file transfer type.
open	Connects to the specified FTP server.
prompt	Toggles prompting. During multiple file transfers, ftp provides prompts to allow you to selectively retrieve or store files; mget and mput transfer all files if prompting is turned off. By default, prompting is on.
put	Copies a local file to the remote computer, using the current file transfer type.
pwd	Prints the current directory on the remote computer.
quit	Ends the FTP session with the remote computer and exits ftp .
quote	Sends arguments, verbatim, to the remote FTP server. A single FTP reply code is expected in return. Identical to literal .
recv	Copies a remote file to the local computer, using the current file transfer type. Identical to get .
remotehelp	Displays help for remote commands.
rename	Renames remote files.
rmdir	Deletes a remote directory.
send	Copies a local file to the remote computer, using the current file transfer type. Identical to put .
status	Displays the current status of FTP connections and toggles.
trace	Toggles packet tracing; displays the route of each packet when

running an FTP command.

type Sets or displays the file transfer type.

user Specifies a user to the remote computer.

verbose Toggles verbose mode. If on, all FTP responses are displayed; when a file transfer completes, statistics regarding the efficiency of the transfer are also displayed. By default, verbose is on.

Nbtstat

This diagnostic command displays protocol statistics and current TCP/IP connections using NetBIOS over TCP/IP.

Syntax

```
nbtstat [-a RemoteName] [-A IP_address] [-c] [-n] [-R] [-r] [-S] [-s] [interval]
```

Parameters

-a

Lists the remote computer's name table given its host name.

-A

Lists the remote computer's name table given its IP address specified in dotted decimal notation.

-c

Lists the contents of the NetBIOS name cache, with the IP address of each name.

-n

Lists local NetBIOS names. In this listing, "Registered" indicates that the name has been registered on this network node, either by b-node broadcast or by a WINS server.

-R

Reloads the LMHOSTS file after purging all names from the NetBIOS name cache.

-r

Lists name resolution statistics for Windows networking. On a computer configured to use WINS, this option returns the number of names resolved and registered broadcast or WINS.

-S

Displays both workstation and server sessions, listing the remote hosts by IP address only.

-s

Displays both workstation and server sessions. It attempts to convert the remote host IP address to a name using the HOSTS file.

interval

Redisplays selected statistics, pausing *interval* seconds between each display. Press CTRL+C to stop redisplaying statistics. If this parameter is omitted, **nbtstat** prints the current configuration information once.

Notes on Nbtstat

The column headings generated by the **nbtstat** utility have the following meanings.

Input

Number of bytes received.

Output

Number of bytes sent.

In/Out

Whether the connection is from the computer (outbound) or from another system to the local computer (inbound).

Life

The remaining time that a name table cache entry will live before it is purged.

Local Name

The local NetBIOS name associated with the connection.

Remote Host

The name or IP address associated with the remote host.

Type

This refers to the type of name. A name can either be a unique name or a group name.

<03>

Each NetBIOS name is 16 characters long. The last byte often has special significance, because the same name can be present several times on a computer. This notation is the last byte converted to hexadecimal. For example, <20> is a space in ASCII.

State

The state of NetBIOS connections as shown in the following list:

State	Meaning
Accepting	An inbound session is currently being accepted and will be connected shortly.
Associated	A connection endpoint has been created and associated with an IP address.
Connected	The session has been established.
Connecting	The session is in the connecting phase where the name-to-IP address mapping of the destination is being resolved.
Disconnected	The local computer has issued a disconnect, and it is waiting for confirmation from the remote computer.
Disconnecting	A session is in the process of disconnecting.
Idle	This endpoint has been opened but cannot receive connections.
Inbound	An inbound session is in the connecting phase.
Listening	This endpoint is available for an inbound connection.
Outbound	A session is in the connecting phase where the TCP connection is currently being created.
Reconnecting	A session is trying to reconnect if it failed to connect on the first attempt.

Command-Line Commands Summary

TCP/IP Utilities

Netstat

This diagnostic command displays protocol statistics and current TCP/IP network connections.

Syntax

netstat [-a] [-ens] [-p *protocol*] [-r] [*interval*]

Parameters

-a

Displays all connections; server connections are usually not shown.

-e

Displays Ethernet statistics. This may be combined with the **-s** option.

-n

Displays addresses and port numbers in numerical form (rather than attempting name look-ups).

-s

Displays per-protocol statistics. By default, statistics are shown for TCP, UDP, ICMP, and IP; the **-p** option may be used to specify a subset of the default.

-p *protocol*

Shows connections for the protocol specified by *protocol*; *protocol* may be **tcp** or **udp**. If used with the **-s** option to display per-protocol statistics, *protocol* may be **tcp**, **udp**, **icmp**, or **ip**.

-r

Displays the contents of the routing table.

interval

Redisplays selected statistics, pausing *interval* seconds between each display. Press CTRL+C to stop redisplaying statistics. If this parameter is omitted, **netstat** prints the current configuration information once.

Notes on Netstat

The **netstat** utility provides statistics on the following network components.

Statistic	Purpose
Foreign Address	The IP address and port number of the remote computer to which the socket is connected. The name corresponding to the IP address is shown instead of the number if the HOSTS file contains an entry for the IP address. In cases where the port is not yet established, the port number is shown as an asterisk (*).
Local Address	The IP address of the local computer, and the port number the connection is using. The name corresponding to the IP address is shown instead of the number if the HOSTS file contains an entry for the IP address. In cases where the port is not yet established, the port number is shown as an asterisk (*).
Proto (state)	The name of the protocol used by the connection. Indicates the state of TCP connections only. The possible states are: the following: close_wait fin_wait_1 syn_received closed fin_wait_2 syn_send established listen timed_waitlast_ack

Command-Line Commands Summary

TCP/IP Utilities

Ping

This diagnostic command verifies connections to one or more remote hosts.

Syntax

ping [-t] [-a] [-n *count*] [-l *length*] [-f] [-i *tll*] [-v *tos*] [-r *count*] [-s *count*]
[[*-j host-list*] | [*-k host-list*]] [*-w timeout*] *destination-list*

Parameters

-t

Pings the specified host until interrupted.

-a

Specifies not to resolve addresses to host names.

-n *count*

Sends the number of echo packets specified by *count*. The default is 4.

-l *length*

Sends echo packets containing the amount of data specified by *length*. The default is 64 bytes; the maximum is 8192.

-f

Sends a Do Not Fragment flag in the packet. The packet will not be fragmented by gateways on the

route.

-i *tll*

Sets the Time To Live field to the value specified by *tll*.

-v *tos*

Sets the Type Of Service field to the value specified by *tos*.

-r *count*

Records the route of the outgoing packet and the returning packet in the Record Route field. A minimum of 1 to a maximum of 9 hosts must be specified by *count*.

-s *count*

Specifies the time stamp for the number of hops specified by *count*.

-j *host-list*

Routes packets by means of the list of hosts specified by *host-list*. Consecutive hosts may be separated by intermediate gateways (loose source routed). The maximum number allowed by IP is 9.

-k *host-list*

Routes packets by means of the list of hosts specified by *host-list*. Consecutive hosts may not be separated by intermediate gateways (strict source routed). The maximum number allowed by IP is 9.

-w *timeout*

Specifies a time-out interval in milliseconds.

destination-list

Specifies the remote hosts to ping.

Note on Ping

The **ping** command verifies connections to remote host or hosts, by sending Internet Control Message Protocol (ICMP) echo packets to the host and listening for echo reply packets. The **ping** command waits for up to 1 second for each packet sent and prints the number of packets transmitted and received. Each received packet is validated against the transmitted message. By default, four echo packets containing 64 bytes of data (a periodic uppercase sequence of alphabetic characters) are transmitted.

You can use the **ping** utility to test both the host name and the IP address of the host. If the IP address is verified but the host name is not, you may have a name resolution problem. In this case, be sure that the host name you are querying is in either the local HOSTS file or in the DNS database.

The following shows sample output for **ping**:

```
C:\>ping ds.internic.net
```

```
Pinging ds.internic.net [192.20.239.132] with 32 bytes of data:
```

```
Reply from 192.20.239.132: bytes=32 time=101ms TTL=243
Reply from 192.20.239.132: bytes=32 time=100ms TTL=243
Reply from 192.20.239.132: bytes=32 time=120ms TTL=243
Reply from 192.20.239.132: bytes=32 time=120ms TTL=243
```

Route

This diagnostic command manipulates network routing tables.

Syntax

route [-f] [*command* [*destination*] [**MASK** *netmask*] [*gateway*]]

Parameters

-f

Clears the routing tables of all gateway entries. If this parameter is used in conjunction with one of the commands, the tables are cleared prior to running the command.

command

Specifies one of four commands.

Command	Purpose
print	Prints a route
add	Adds a route
delete	Deletes a route
change	Modifies an existing route

destination

Specifies the host-to-send *command*.

MASK

Specifies, if present, that the next parameter be interpreted as the *netmask* parameter.

netmask

Specifies, if present, the subnet mask value to be associated with this route entry. If not present, this parameter defaults to 255.255.255.255.

gateway

Specifies the gateway.

Telnet

This connectivity command starts terminal emulation with a remote system running a Telnet service. Telnet provides DEC™ VT 100™, DEC VT 52, or TTY emulation, using connection-based services of TCP.

To provide terminal emulation from a Windows 95 computer, the foreign host must be configured with the TCP/IP program, the Telnet server program or daemon, and a user account for the computer running Windows 95.

The Telnet application is found in the Accessories program group if you install the TCP/IP connectivity utilities. Telnet is a Windows Sockets-based application that simplifies TCP/IP terminal emulation with Windows 95.

Note Microsoft does not provide the Telnet server daemon (**telnetd**).

Syntax

telnet [*host* [*port*]]

Parameters

host

Specifies the host name or IP address of the remote system you want to connect to, providing compatibility with applications such as Gopher and Mosaic.

port

Specifies the remote port you want to connect to, providing compatibility with applications such as Gopher and Mosaic. The default value is specified by the **telnet** entry in the SERVICES file. If no entry exists in the SERVICES file, the default connection port value is decimal 23.

Tracert

This diagnostic utility determines the route taken to a destination by sending Internet Control Message Protocol (ICMP) echo packets with varying Time-To-Live (TTL) values to the destination. Each router along the path is required to decrement the TTL on a packet by at least 1 before forwarding it, so the TTL is effectively a hop count. When the TTL on a packet reaches 0, the router is supposed to send back an ICMP Time Exceeded message to the source system. The **tracert** command determines the route by sending the first echo packet with a TTL of 1 and incrementing the TTL by 1 on each subsequent transmission until the target responds or the maximum TTL is reached. The route is determined by examining the ICMP Time Exceeded messages sent back by intermediate routers. Notice that some routers silently drop packets with expired TTLs and are invisible to **tracert**.

Syntax

```
tracert [-d] [-h maximum_hops] [-j host-list] [-w timeout] target_name
```

Parameters**-d**

Specifies not to resolve addresses to host names.

-h *maximum_hops*

Specifies maximum number of hops to search for target.

-j *host-list*

Specifies loose source route along *host-list*.

-w *timeout*

Waits the number of milliseconds specified by *timeout* for each reply.

target_name

Specifies the host name of the destination computer.

Notes on Tracert

The following shows sample output for **tracert**. The first column is the hop number, which is the Time To Live (TTL) value set in the packet. Each of the next three columns contains the round-trip times in milliseconds for an attempt to reach the destination with that TTL value. An asterisk (*) means that the attempt timed out. The fourth column is the host name (if it was resolved) and IP address of the responding system.

```
C:\>tracert ds.internic.net
```

```
Tracing route to ds.internic.net [198.49.45.10]
over a maximum of 30 hops:
```

```
 1  <10 ms  <10 ms  *      [131.107.1.100]
 2   10 ms  <10 ms  10 ms  seattle1-gw.nwnet.net [192.80.12.82]
 3   *      10 ms  10 ms  enss143-enet.nwnet.net [192.35.180.2]
 4   20 ms  *      10 ms  t3-3.seattle-cnss8.t3.ans.net [140.222.88.4]
 5   30 ms  30 ms  20 ms  t3-0.los-angeles-cnss8.t3.ans.net [140.222.8.1]
 6   70 ms  70 ms  80 ms  t3-0.new-york-cnss24.t3.ans.net [140.222.24.1]
 7   80 ms  81 ms  80 ms  t3-0.denver-cnss40.t3.ans.net [140.222.40.1]
 8  100 ms  91 ms  90 ms  t3-1.new-york-cnss32.t3.ans.net [140.222.32.2]
 9   90 ms  90 ms  91 ms  mf-0.new-york-cnss36.t3.ans.net [140.222.32.196]
10  100 ms  90 ms  91 ms  t1-0.enss222.t3.ans.net [140.222.222.1]
11  140 ms  191 ms  100 ms  ds.internic.net [198.49.45.10]
```

```
Trace complete.
```

Introduction

This appendix provides an overview of information about the system files supplied with Windows 95.

- [Windows 95 Distribution Disk Storage Overview](#)
- [Using the Extract Program to Extract Files](#)
- [Setup Files Overview](#)
- [Directory File Structure and File Locations](#)
 - [Location of Key System Files](#)
 - [Location of System Files on Compressed Disks](#)

Windows 95 Distribution Disk Storage Overview

Windows 95 is stored on the distribution disks as cabinet files (*.CAB). When the Windows 95 disks are created, files are compressed into folders. The Windows 95 files are read in and written as one, continuous byte-stream, which compresses the entire stream and divides it into folders as appropriate. Folders can fill one or more cabinets. The following defines the terms used to describe the distribution files.

Cabinet.

A normal file that contains pieces of one or more files, usually compressed.

Folder.

A decompression boundary. Large folders enable higher compression, because the compressor can refer back to more data in finding patterns. However, to retrieve a file at the end of a folder, the entire folder must be decompressed.

The Windows 95 distribution disks use distribution media format (DMF), which is a special read-only format for 3.5-inch floppy disks that permits storage of 1.7 MB of data.

Using the Extract Program to Extract Files

The Extract program supports command-line extraction of files from the cabinet (*.CAB) storage format on disk. Extract does not support any other compression system (that is, it is not backward-compatible with any previous Microsoft disk utilities).

The Extract program (EXTRACT.EXE) can be found in the Windows COMMAND directory, or on the Windows 95 disks.

Important The information in this section is provided for use if your product support representative indicates that you should use the Extract program to extract a compressed file from the Windows 95 cabinet files.

In general, you should use the Add/Remove Programs or Network options in Control Panel to install applications and supporting software from the Windows 95 disks.

If system files are missing or damaged, run Windows 95 Setup from the Windows 95 disks (or network distribution source), and choose the option to validate and restore files.

Syntax

extract [*/y*] *compressed_file* [*destination_file*]

– Or –

extract [*/y*] [*/A*] [*/D* | */E*] [*/L location*] *cabinet_file* [*file_specification ...*]

Parameters

/A

Process all files in a cabinet set, starting with the *cabinet_file*.

/D

Provide only a directory listing (do not extract).

/E

Force extraction.

/L location

Use the directory specified by *location*, instead of the current directory, as the default location to place extracted files.

/Y

Overwrite files in the destination without prompting. The default is to prompt the user if the destination file already exists, and allow one of the following:

- Overwrite the file
- Skip the file
- Overwrite this file and all subsequent files that may already exist
- Exit

compressed_file

This is a cabinet file that contains a single file (for example, FILE1.EX_, which contains FILE1.EXE). If *destination_file* is not specified, then the file is extracted and given its original name in the current directory.

destination_file

This can be either a relative path (., .., C:FILE1, and so on) or a fully qualified path. This can specify either a file (or files, if wildcards are included) or a directory. If a directory is specified, then the filename stored in the cabinet is used. Otherwise, *destination_file* is used as the complete filename for the extracted file.

cabinet_file

This is a cabinet file that contains two or more files. If no *file_specification* parameter is specified, then a list is displayed of the files in the cabinet. If one or more *file_specification* parameters are

specified, then these are used to select the files to be extracted from the cabinet. Wildcards are allowed to specify multiple cabinets.

file_specification

This specifies files to be extracted from the cabinets. This can contain the ? and * wildcards. Multiple *file_specification* values can be supplied.

The following table provides some examples.

Command	Behavior
extract <i>filename.ex_</i>	Assuming <i>filename.ex_</i> contains just the single file FILENAME.EXE, then <i>filename.exe</i> is extracted and placed in the current directory.
extract <i>filename.ex_</i> <i>file2.exe</i>	Assuming <i>filename.ex_</i> contains just the single file <i>filename.exe</i> , then <i>filename.exe</i> is extracted and placed in the current directory in the file <i>file2.exe</i> .
extract <i>cabinet.1</i>	Assuming <i>cabinet.1</i> contains multiple files, then a list of the files stored in that cabinet is displayed.
extract <i>cabinet.1</i> *.exe	Extracts all .EXE files from <i>cabinet.1</i> and places them in the current directory.

Windows 95 System Files

Setup Files Overview

The following table describes the key files used for Windows 95 Setup.

Filename	Description
setup.exe	The real-mode Setup component that initializes Windows 95 Setup. If this file is started from MS-DOS, it calls the real-mode stub. If started from within Windows, it is a 16-bit Windows stub.
suwin.exe	The protected-mode Setup components responsible for calling all other DLLs used in Setup.
setupx.dll	The primary DLL used during the Copy Files phase to perform most of the installation procedures. It is responsible for reading INF files, handling disks, and copying files.
netdi.dll	The module called early in the Setup process to install networking services.

Also, the WININSTx.400 directory is created at the beginning of the Windows 95 Setup process. This directory contains a minimal set of files used during setup and requires about 6 to 7 MB of free disk space. This directory is removed upon successful completion of Windows 95 installation.

Windows 95 System Files

Directory File Structure and File Locations

The following shows the typical default directory structure created for Windows 95.

```
\Windows
  Command
  Config
  Cursors
  Desktop
  Fonts
  Help
  Inf
  Media
  Pif
  Recent
  Sendto
  Spool
    Printers
  Start Menu
  Programs
    Accessories
    Games
    Multimedia
    System
    StartUp
  Sysbckup
  System
    Color
    Iosubsys
    Viewers
    Vmm32
  Temp
```

Location of Key System Files

The following table lists the directories where various types of Windows 95 system files and supporting files are stored.

Key Paths to Windows 95 Files

File type	Directory¹
Core Windows 95 files	Windows
Shortcuts to applications	Windows PROGRAMS
MS-DOS commands	Windows COMMAND
Printer drivers	Windows SPOOL\PRINTERS
Help files	Windows HELP
Font files	Windows FONTS
Setup and device installation files	Windows INF
PIF files	Windows PIF
Drivers	Windows SYSTEM
VxDs	Windows SYSTEM
I/O Subsystem	Windows SYSTEM\IOSUBSYS
Viewers	Windows SYSTEM\VIEWERS
VxDs added after installation	Windows SYSTEM\VMM32

¹ "Windows" refers to the directory that is specified during the installation process to contain the Windows 95 files.

The following table shows where key Windows 95 files are stored when Windows 95 is installed on the local hard disk of a computer. For information about installing Windows 95 on a server for a network client computer to run a shared copy, see [Server-Based Setup for Windows 95](#).

Location of Key Windows 95 Files

Description	Filename	Location
Real-mode operating system and system detection	IO.SYS	Root directory of startup drive
Command-line processor	COMMAND.COM	Root directory of startup drive
Real-mode stub to start Windows 95	WIN.COM	Windows
Protected-mode Virtual Machine Manager (VMM)	VMM32.VXD	Windows SYSTEM
Registry	SYSTEM.DAT	Windows
Registry current backup	SYSTEM.DA0	Windows
Registry when first created by Setup	SYSTEM.NEW	Windows
User Registry	USER.DAT	Windows
User Registry first created by Setup	USER.NEW	Windows
Log of the Setup process	SETUPLOG.TXT	Root directory of startup drive
Hardware detection log	DETLOG.TXT	Root directory of startup drive

Log of Windows 95 startup process	BOOTLOG.TXT	drive Root directory of startup drive
Real-mode network configuration	PROTOCOL.INI	Windows

Windows 95 System Files

Directory File Structure and File Locations

Location of System Files on Compressed Disks

If you install Windows 95 on a compressed drive, Windows 95 Setup will place the following files on the boot drive.

Windows 95 Files on the Boot Drive

AUTOEXEC.BAT	DBLSPACE.BIN ¹	MSDOS.SYS ¹
AUTOEXEC.DOS	DETLOG.TXT ¹	NETLOG.TXT
BOOTLOG.PRV ¹	DRVSPACE.BIN ¹	SETUPLOG.TXT ¹
BOOTLOG.TXT ¹	DRVSPACE.INI ¹	SUHDLOG.DAT ¹
COMMAND.COM	IO.DOS ¹	SYSTEM.1ST ¹
COMMAND.DOS	IO.SYS ¹	WINA20.386
CONFIG.DOS	MSDOS.--- ¹	
CONFIG.SYS	MSDOS.DOS ¹	

¹ Indicates a hidden file.

The WIN386.SWP file is added to the host drive by Windows 95 Setup. Although the host drive is usually the same as the boot drive, it doesn't have to be. For example, if part of drive D is used to create the compressed drive H, then D is the host for H, but C is the host drive. Therefore, WIN386.SWP will be placed in the root of D if Windows is installed on drive H. The remaining Windows 95 files are placed on the compressed drive in the specified Windows directory.

Windows 95 Setup adds the same files as listed earlier in this section to the boot drive when installing Windows 95 on an uncompressed drive that is not the boot drive. The only difference is that WIN386.SWP will be placed on the same drive as the Windows directory. For example, if you have drives C and D, and if you install Windows 95 on D:\WINDOWS, then WIN386.SWP will be on the root of D. Otherwise, it will be placed as described earlier for compressed drives.

Introduction

This appendix describes the structure for the information files (INF) used to configure devices and networking components in Windows 95.

This information is of particular use if you are creating custom setup scripts. This description of the INF file format will help you read the information in the Windows 95 INF files to find the values to be provided in MSBATCH.INF. The general format is also used for statements in the [Install] section of MSBATCH.INF.

- [Windows 95 Device Information Files Overview](#)
- [General INF File Format](#)
- [\[Version\] Section](#)
- [\[Manufacturer\] Section](#)
- [\[Manufacturer Name\] Section](#)
- [\[Install\] Section](#)
 - [\[Logical Configuration\] Sections](#)
 - [\[Update AutoExec\] Section](#)
 - [\[Update Config\] Section](#)
 - [\[Update INI\] Section](#)
 - [\[Update IniFields\] Section](#)

 - [\[Add Registry\] Section](#)
 - [\[Delete Registry\] Section](#)
 - [\[Ini to Registry\] Section](#)
 - [\[DestinationDirs\] Section](#)
 - [\[File-List\] Section](#)
 - [\[SourceDisksFiles\] Section](#)
 - [\[SourceDisksNames\] Section](#)
- [\[ClassInstall\] Section](#)
- [\[Strings\] Section](#)
- [Sample INF File](#)

Windows 95 Device Information Files Overview

Device information (INF) files provide information used by Windows 95 to install software that supports a given hardware device. When hardware manufacturers introduce new products, they must create INF files to explicitly define the resources and files required for each class of device.

The format of the INF files is based on Windows 3.x INF files:

- Section names are enclosed in brackets ([]) and must be unique within an INF file.
- Keys within a section do not have to be unique, but the order of keys within a section is significant.
- Private sections in an INF file are not evaluated by Windows 95.

The operating system detects the unique ID of each device installed. For the device identified, a specific section of the INF file provides information on that class of device; the following describes the information contained in a typical INF file section.

General INF File Format

An INF file is organized in several sections which define information that Setup and the hardware detection process use to determine the resource needs of the hardware device and to install software for that device. An INF file is organized by hardware, with each class of device described in its own section. Within each device section, the following general organization applies.

[Version] section

Contains a simple header that identifies the INF and the class of device this INF supports.

[Manufacturer] and [Manufacturer Name] sections

Lists all the individual manufacturers of the devices identified in this file and lists all the devices built by that manufacturer. These entries are displayed directly to the user and used to generate the appropriate Registry entries. There must always be at least one manufacturer section.

[Install] section

Describes the device driver and physical attributes of the hardware device. It also identifies the names of all the [Install] sections that contain information and instructions for installing this device.

[ClassInstall] section

Defines a new class for this device. Optional.

Miscellaneous control section

Specifies how a device is handled by the Windows 95 user interface.

[Strings] section

Defines all localizable strings used in the INF file.

Each section contains one or more entries. The typical entry consists of a key and a value separated by an equal sign. Keys within a section do not have to be unique, but the order of keys may be significant depending on the purpose of the section. An INF file can include comments — any string of text, up to the end of the line, that starts with a semicolon. A comment can start anywhere on a line. For example:

```
Key=value ; comment
```

For complete details about the syntax and use of statements in Windows 95 INF files, see the *Win32 Software Development Kit for Windows 95 and Windows NT*.

[Version] Section

Syntax

```
[Version]  
Signature="$Chicago$"  
Class=class-name  
Provider =INF_creator  
LayoutFile=filename.inf
```

The [Version] section defines the standard header for all Windows 95 INF files.

class-name

Defines the class in the Registry for any device installed from this INF. The following are some examples of class names:

Adapter	Hdc	Monitor	PCMCIA
Cdrom	Keyboard	Mouse	Ports
Display	MCADevices	MTD	Printer
EISADevices	Media	NetNetService	SCSIAdapter
Fdc	Modem	Nodriver	System

filename.inf

Names the INF file that contains the layout information (source disks and files) required for installing this driver software. Typically, for Windows 95 components, this is LAYOUT.INF. This line is optional.

If not given, the [SourceDisksNames] and [SourceDisksFiles] sections must be given in this INF.

This example shows a typical [Version] section:

```
[Version]  
Signature="$Chicago$"  
Provider=%MSFT%  
Class=Adapter  
LayoutFile=LAYOUT.INF
```

[Manufacturer] Section

Syntax

[Manufacturer]

manufacturer-name | %*strings-key*%=*manufacturer-name-section*

The [Manufacturer] section identifies the manufacturer of the device and specifies the name of the [*Manufacturer Name*] section that contains additional information about the device driver.

manufacturer-name

Name of the manufacturer. This name can be any combination of printable characters, but must uniquely identify the manufacturer and must be enclosed in double quotation marks.

strings-key

Name of a string as defined in a [Strings] section.

manufacturer-name-section

Name of the [*Manufacturer Name*] section. This name can be any combination of printable characters, but must uniquely identify the manufacturer name.

The following example shows a typical [Manufacturer] section in which a string key, %M1%, is used to identify the manufacturer. In this example, the [*Manufacturer Name*] section is APEXD.

```
[Manufacturer]
%M1%=APEXD      ; Strings key for this manufacturer
```

[Manufacturer Name] Section

Syntax

[*manufacturer-name*]

device-description=install-section-name, device-id[,compatible-device-id]...

The [*Manufacturer Name*] section gives the device description and identifies the [*Install*] section for this device. The *manufacturer-name-section* name must be defined in the [Manufacturer] section.

device-description

Description of the device to install. This can be any combination of printable characters or a strings key.

install-section-name

Name of the [*Install*] section for this device.

device-id

Identifier for this device.

compatible-device-id

Identifier of a compatible device. More than one compatible-device identifier can be given, but each must be preceded by a comma.

The following example shows a typical [*Manufacturer Name*] section. The name of the [*Install*] section for this device is SuperSCSI. This device-id is *PNPA000 and its compatible device identifier is *PnPA001.

```
[APEXD]
```

```
%DevDesc1% = SuperSCSI, *PNPA000, *PnPA001
```

For each driver installed using this INF file, Setup uses the information in these [*Manufacturer Name*] sections to generate Driver Description, Manufacturer Name, DeviceID, and Compatibility list entries in the Registry.

[Install] Section**Syntax**

[install-section-name]

LogConfig = log-config-section-name[,log-config-section-name]...

Copyfiles=file-list-section[,file-list-section]...

Renfiles=file-list-section[,file-list-section]...

Delfiles=file-list-section[,file-list-section]...

UpdateInis=update-ini-section[,update-ini-section]...

UpdateIniFields=update-inifields-section[,update-inifields-section]...

AddReg=add-registry-section[,add-registry-section]...

DelReg=del-registry-section[,del-registry-section]...

Ini2Reg=ini-to-registry-section[,ini-to-registry-section]...

UpdateCfgSys=update-config-section

UpdateAutoBat=update-autoexec-section

Reboot | Restart

The *[Install]* section identifies the additional sections in the INF file that contain descriptions of the device and instructions for installing files and information needed by the device drivers. The *install-section-name* must be defined in a *[Manufacturer Name]* section and consist of printable characters.

Not all entries in this section are needed or required. If an entry is given, it must specify the name of a section. (An exception to this is the **CopyFiles** entry.) More than one name can be given for each entry, but each additional name must be preceded by a comma. The exact format and meaning of the corresponding entry depends on the entry type and is described in later *sections*. Each *[Install]* section should include the creation date of the driver set.

The **Reboot** or **Restart** entries can be added to the *[Install]* section to force the system to either restart or to reboot the machine after performing the commands in the *[Install]* section.

This example shows a typical *[Install]* section. It contains a **LogConfig** entry that identifies two logical configuration sections for this device. It also contains **Copyfiles** and **AddReg** entries that identify the sections containing information about which files to install.

```
[SuperSCSI]
; Apex Drivers Model 01 - SuperSCSI+
Log_Config = With_Dma, WithoutDMA
Copyfiles=MoveMiniPort, @SRSutil.exe
AddReg=MOD1
```

The **CopyFiles** entry provides a special notation that allows a single file to be copied directly from the copy line. An individual file can be copied by prefixing the file name with an @ symbol. The destination for any file copied using this notation will be the **DefaultDestDir** as defined in the *[DestinationDirs]* section. The following example shows how to copy individual files:

```
CopyFiles=FileSection1,@myfile.txt,@anotherfile.txt,LastSectionName
```

Windows 95 INF Files

[Install] Section

[Logical Configuration] Sections

Syntax

[log-config-section-name]

ConfigPriority = *priority-value*

MemConfig = *mem-range-list*

I/OConfig = *io-range-list*

IRQConfig = *irq-list*

DMACConfig = *dma-list*

A *[Logical Configuration]* section defines configuration details, such as IRQs, memory ranges, I/O ports, and DMA channels. An INF file can contain any number of *[Logical Configuration]* sections, as many as are needed to describe the device dependencies. However, each section must contain complete details for installing a device. The *log-config-section-name* must be defined by the **LogConfig** entry in the *[Install]* section.

Not all entries are needed or required. If an entry is given, it must be given appropriate values as described in the subsequent *sections*.

Each entry can specify more than one resource. However, during installation only one resource from an entry is used. If a device needs multiple resources of the same type, multiple entries must be given. For example, to ensure two IRQs for a device, two **IRQConfig** entries must be given. If a device does not require an IRQ, no **IRQConfig** entry should be given. For each entry, Setup builds binary logical configuration records and adds these to the driver section of the Registry.

Windows 95 INF Files

[Install] Section

[Update AutoExec] Section

Syntax

[update-autoexec-section]

CmdDelete=*command-name*

CmdAdd=*command-name*[,*command-parameters*]

UnSet=*env-var-name*

PreFixPath=*ldid*[,*ldid*]

RemOldPath=*ldid*[,*ldid*]

TmpDir=*ldid*[,*subdir*]

The *[Update AutoExec]* section provides commands to manipulate lines in the AUTOEXEC.BAT file.

The *update-autoexec-section* name must appear in an **UpdateAutoBat** entry in the *[Install]* section.

Not all entries are needed or required. The section can contain as many **CmdAdd**, **CmdDelete**, and **UnSet** entries as needed, but only one entry for **PreFixPath**, **RemOldPath**, and **TmpDir** can be used per file.

Setup processes all **CmdDelete** entries before any **CmdAdd** entries.

For information about LDID values, see [\[Update INI\] Section](#).

Windows 95 INF Files

[Install] Section

[Update Config] Section

Syntax

[update-config-section]

DevRename=*current-dev-name,new-dev-name*

DevDelete=*device-driver-name*

DevAddDev=*driver-name,configkeyword[,flag][,param-string]*

Stacks=*dos-stacks-values*

Buffers=*legal-dos-buffer-value*

Files=*legal-dos-files-value*

LastDrive=*legal-dos-lastdrive-value*

The *[Update Config]* section provides commands to add, delete, or rename commands in CONFIG.SYS. The *update-config-section* name must appear in an **UpdateCfgSys** entry in the *[Install]* section.

Not all entries are needed or required. This section may contain as many **DevRename**, **DevDelete**, and **DevAddDev** entries as needed, but the other commands may only be used once per section. When processing this section, Setup processes all **DevRenames** entries first, all **DevDelete** commands second, and all **DevAddDev** commands last.

[Update INI] Section

Syntax

[*update-ini-section*]

ini-file, *ini-section*, [*old-ini-entry*], [*new-ini-entry*], [*flags*]

.
:
.

Replaces, deletes, or adds entries in the given INI file. This is similar to the INF support in Windows 3.1. The *update-ini-section* name must appear in an **UpdateInis** entry in the [*Install*] section. The optional action *flags* can be one of these values:

- 0 Default. Matches Value of *old-ini-entry* Key, ignores its value. If Key is present, replaces with *new-ini-entry*. If *old-ini-entry* is NULL, the *new-ini-entry* is added unconditionally. If *new-ini-entry* is NULL, the *old-ini-entry* is deleted.
- 1 Matches both Key and Value of *old-ini-entry*. Update is done only if both Key and Value match.
- 2 Conditional and matches only the Key of *old-ini-entry*. If Key in *old-ini-entry* already exists, do not replace with *new-ini-entry*.
- 3 Conditional and matches both Key and Value of *old-ini-entry*. If the *Key=Value* of *old-ini-entry* exists, do not replace with *new-ini-entry*.

The wildcard character (*) can be used in specifying the Key and Value, and they will be interpreted correctly.

The *ini-file* name can be a string or a strings key. A strings key has the form %*strkey*% where *strkey* is defined in the [Strings] section in the INF file. In either case, the name must be a valid filename.

The name should include the name of the directory containing the file, but the directory name should be given as a logical directory identifier (LDID) rather than an actual name. Setup replaces an LDID with an actual name during installation.

An LDID has the form %*ldid*% where *ldid* is one of the predefined identifiers or an identifier defined in the [DestinationDirs] section. For LDID_BOOT and LDID_BOOTHOST, the backslash is included in the LDID, so %30%boot.ini is the correct way to reference BOOT.INI in the root of the boot drive.

The following examples illustrate entries in this section:

```
%11%\sample.ini, Section1,, Value1=2 ; adds new entry
%11%\sample.ini, Section2, Value3=*, ; deletes old entry
%11%\sample.ini, Section4, Value5=1, Value5=4 ; replaces old entry
```

Windows 95 INF Files

[Install] Section

[Update IniFields] Section

Syntax

[update-inifields-section]

ini-file, ini-section, profile-name, [old-field], [new-field]

Replaces, adds, and deletes fields in the value of a given INI entry. Unlike the *[Update INI]* section, this section replaces, adds, or deletes portions of a value in an entry rather than the whole value. The *update-inifields-section* name must appear in an **UpdateIniFields** entry in the *[Install]* section.

Any previous comments in the line are removed because they might not be applicable after changes. When looking in the INI file for fields in the line, spaces, tabs, and commas are used as field delimiters. However, a space is used as the separator when the new field is appended to the line.

Windows 95 INF Files

[Install] Section

[Add Registry] Section

Syntax

[*add-registry-section*]

reg-root-string, [*subkey*], [*value-name*], [*Flag*], [*value*]

.

.

.

Adds subkeys or value names to the Registry, optionally setting the value. The *add-registry-section* name must appear in an **AddReg** entry in the [*Install*] section.

Windows 95 INF Files

[Install] Section

[Delete Registry] Section

Syntax

[del-registry-section]

reg-root-string, subkey, [value-name]

.
.
.

Deletes a subkey or value name from the Registry. The *del-registry-section* name must appear in an **DelReg** entry in the *[Install]* section. This section can contain any number of entries. Each entry deletes one subkey or value name from the Registry.

Windows 95 INF Files

[Install] Section

[Ini to Registry] Section

Syntax

[*ini-to-registry-section*]

ini-file, ini-section, [ini-key], reg-root-string, subkey, flags

.
.
.

Moves lines or sections from an INI file to the Registry, creating or replacing an entry under the given key in the Registry. The *ini-to-registry-section* name must appear in an **Ini2Reg** entry in the [*Install*] section.

[DestinationDirs] Section

Syntax

[DestinationDirs]

file-list-section=*ldid*[,*subdir*]

.
.
.

DefaultDestDir=*ldid*[,*subdir*]

The [DestinationDirs] section defines the destination directories for the given [*File-List*] sections and optionally defines the default directory for any [*File-List*] sections that are not explicitly named.

file-list-section

Name of a [*File-List*] section. This name must have been defined in a **Copyfiles**, **RenFiles**, or **DelFiles** entry in the [*Install*] section.

ldid

A logical disk identifier (LDID). Can be one of these values:

- 00 Null LDID; this LDID can be used to create a new LDID
- 01 Source drive:\ pathname
- 02 Temporary Setup directory; this is valid only during Windows 95 Setup
- 03 Uninstall directory
- 04 Backup directory
- 10 Windows directory
- 11 SYSTEM directory
- 12 IOSUBSYS directory
- 13 COMMAND directory
- 14 Control Panel directory
- 15 Printers directory
- 16 Workgroup directory
- 17 INF directory
- 18 Help directory
- 19 Administration
- 20 Fonts
- 21 Viewers
- 22 VMN32
- 23 Color directory
- 25 Shared directory
- 26 Winboot
- 27 Machine specific
- 28 Host Winboot
- 30 Root directory of the boot drive
- 31 Root directory for host drive of a virtual boot drive
- 32 Old Windows directory if it exists
- 33 Old MS-DOS directory if it exists

subdir

Name of the directory, within the directory named by *ldid*, to be the destination directory.

The optional **DefaultDestDir** entry provides a default destination for any **Copyfile** entries that use the direct copy notation (@filename) or any *[File-List]* section not specified in the [DestinationDirs] section. If **DefaultDestDir** is not given, the default directory is set to LDID_WIN.

This example sets the destination directory for the MoveMiniPort section to the Windows IOSUBSYS directory, and sets the default directory for other sections to be the BIN directory on the boot drive:

```
[DestinationDirs]
MoveMiniPort=12
; Destination for MoveMiniPort Section is windows\iosubsys
DefaultDestDirs=30,bin ; Direct copies go to Boot:\bin
```

Windows 95 INF Files

[Install] Section

[File-List] Section

A *[File-List]* section lists the names of files to be copied, renamed, or deleted. Entries in this section have three forms, depending on the type of entry in the *[Install]* section that defines the section name.

A *[File-List]* section for a **CopyFiles** entry has this form:

[file-list-section]

destination-file-name,*[source-file-name]*,*[temporary-file-name]*

The *file-list-section* name must appear in the **CopyFiles** entry.

destination-file-name

Name of the destination file. If no source filename is given, this is also the name of the source file.

source-file-name

Name of the source file. Required only if the source and destination names are not the same.

temporary-file-name

Name of the temporary file for the copy. Setup copies the source file but gives it the temporary filename. The next time Windows 95 starts, it renames the temporary file to the destination filename.

This is useful for copying files to a destination that is currently open or in use by Windows.

The following example copies three files:

```
[CopyTheseFilesSec]
```

```
file11                ; copies file11  
file21, file22, file23 ; copies file22, temporarily naming it file23  
file31, file32        ; copies file32 to file31
```

A *[File-List]* section for a **RenFiles** entry has this form:

[file-list-section]

new-file-name,*old-file-name*

.
.
.

The *file-list-section* name must appear in the **RenFiles** entry.

This example renames the files FILE42, FILE52, and FILE62 to FILE41, FILE51, and FILE61, respectively:

```
[RenameOldFilesSec]
```

```
file41, file42  
file51, file52  
file61, file62
```

A *[File-List]* section for a **DelFiles** entry has this form:

[file-list-section]

filename

.
.
.

The *file-list-section* name must appear in the **DelFiles** entry.

This example deletes three files:

```
[DeleteOldFilesSec]
```

```
file1  
file2  
file3
```

In the preceding examples, the given filenames are assumed to have been defined in the

[SourceDisksFiles] section and the logical disk numbers that appear in this section have been defined in the [SourceDisksNames] section.

Windows 95 INF Files

[Install] Section

[SourceDisksFiles] Section

Syntax

[SourceDisksFiles]

filename=disk-number

.
.
.

Names the source files used during installation and identifies the source disks that contain the files. The ordinal of the source disk defined in *disk-number* must be defined in the [SourceDiskNames] section.

This example identifies a single source file, SRS01.386, on the disk having ordinal 1:

```
[SourceDisksFiles]  
SRS01.386 = 1
```

Windows 95 INF Files

[Install] Section

[SourceDisksNames] Section

Syntax

[SourceDisksNames]

disk-ordinal="disk-description",disk-label,disk-serial-number

Identifies and names the disks used for installation of the given device drivers.

This example identifies one source disk and assigns it ordinal 1. The disk description is given as a strings key:

```
[SourceDisksNames]
```

```
1 = %ID1%, Instd1, 0000-0000
```

[ClassInstall] Section

Syntax

[ClassInstall]

Copyfiles=*file-list-section*[,*file-list-section*]...

AddReg=*add-registry-section*[,*add-registry-section*]...

Renfiles=*file-list-section*[,*file-list-section*]...

Delfiles=*file-list-section*[,*file-list-section*]...

UpdateInis=*update-ini-section*[,*update-ini-section*]...

UpdateIniFields=*update-inifields-section*[,*update-inifield-section*]...

AddReg=*add-registry-section*[,*add-registry-section*]...

DelReg=*del-registry-section*[,*del-registry-section*]...

The [ClassInstall] section installs a new class for a device in the [Class] section of the Registry. Every device installed in Windows 95 has a class associated with it (even if the class is "UNKNOWN"), and every class has a class installer associated with it. Setup processes this section if one of the devices defined in this INF file is about to be installed and the class is not already defined. Not all entries are needed or required.

The following example specifies the class entry for Setup to create in the Registry (AddReg=SampleClassReg), and specifies a normal [*Install*] section in [SampleClassReg]. In this example, the Class description is required, and the relative key (HKR) denotes the class section. This example creates the class Sample and registers the description, installer, and icon for the class:

```
[ClassInstall]
Addreg=SampleClassReg
CopyFiles=@Sample.cpl

[SampleClassReg]
HKR,,, %SampleClassDesc%
HKR,, Installer,, Sample.cpl
HKR,, Icon, HEX, 00, 00
```

[Strings] Section

Syntax

[Strings]

strings-key=value

.
:
.

The [Strings] section defines one or more strings keys. A strings key is a name that represents a string of printable characters. Although the [Strings] section is generally the last section in the INF files, a strings key defined in this section may be used anywhere in the INF file that the corresponding string would be used. Setup expands the strings key to the given string and uses it for further processing. Using a strings key requires that it be enclosed in percent signs (%). The [Strings] section makes localization easier by placing all localizable text in the INF file in a single section. Strings keys should be used whenever possible.

strings-key

A unique name consisting of letters and digits.

value

A string consisting of letters, digits, or other printable characters. It should be enclosed in double quotation marks if the corresponding strings key is used in an entry that requires double quotation marks.

The following example shows the [Strings] section for a sample INF file.

```
[Strings]
MSFT="Microsoft"
M1="APEX DRIVERS"
DevDesc1=APEX DRIVERS SCSI II Host Adapter
ID1="APEX DRIVERS SuperSCSI Installation disk"
```

Windows 95 INF Files

Sample INF File

This example assumes a fictitious piece of hardware, a SCSI II Host Adapter built by a company named Apex Drivers. The board requires four I/O ports that can be based at 180H, 190H, 1A0h, or 1B0h. The board requires one exclusive IRQ chosen from 4,5,9,10, or 11. The board can use a DMA channel if one is assigned.

```
;SCSI.INF
;
; Standard comment

[Version]
Signature="$Chicago$"
Provider=%MSFT%
HardwareClass=SCSIAdapter

[Manufacturer]
%M1%=APEXD ; Strings key for this manufacturer

[APEXD]
%DevDesc1% = SuperSCSI, *PNPA000, *PnPA001

[SuperSCSI]
; Apex Drivers Model 01 - SuperSCSI+
Log_Config = With_Dma, WithoutDMA
Copyfiles=MoveMiniPort, @SRSutil.exe
AddReg=MOD1

[With_DMA]
; Primary Logical Configuration
ConfigPriority = NORMAL
I/OConfig = 4@180-1B3%fff0(3:0:)
; Allocate 4 ports at base 180,190,1A0 or 1B0, device decodes
; 10bits of I/O address and uses no Aliases.
IRQConfig = 4,5,9,10,11 ; Allocate Exclusive IRQ 4, 5, 9, 10 or 11
DMAConfig = 0,1,2,3 ; Allocate DMA Channel 0, 1 ,2 or 3

[Without_DMA]
; Secondary Logical Configuration
ConfigPriority = SUBOPTIMAL
I/OConfig = 4@180-1B3%fff0(3:0:)
IRQConfig = 4,5,9,10,11

[MOD1]
HKR,,DevLoader,,I/OS
HKR,,Miniport,,SRSmini.386

[DestinationDirs]
MoveMiniPort=12
; Destination for MoveMiniPort Section is windows\iosubsys
DefaultDestDirs=30,bin ; Direct copies go to Boot:\bin

[SourceDiskSFiles]
SRS01.386 = 1

[SourceDisksNames]
1 = %ID1%, Instd1, 0000-0000

[MoveMiniPort]
SRS01.386

[Strings]
MSFT="Microsoft"
M1="APEX DRIVERS"
DevDesc1=Apex Drivers SCSI II Host Adapter
ID1="Apex Drivers SuperSCSI Installation disk"
```

Introduction

Windows 95 Setup can be run with setup scripts to automate installation when you have defined the options and parameters to be installed on users' computers.

Customization actions that required editing Windows 3.x INF files are all accomplished by means of statements in setup scripts that use MSBATCH.INF format. For information about the procedures for creating and using setup scripts, see [Custom, Automated, and Push Installations](#).

Setup Script Parameters

[Setup]

[System]

[NameAndOrg]

[InstallLocationsMRU]

[OptionalComponents]

[Network]

[netcard_ID]

[MSTCP]

[NWLink]

[NWRedir]

[NWServer]

[VRedir]

[VServer]

[Printers]

[Strings]

[Install]

MSBATCH.INF Sample File

Windows 95 Network Adapter INF Summary

Setup Script Parameters

This section summarizes the parameters that can be used in setup scripts.

Setup-Related Parameters**[Setup] parameters:**

Devicepath	InstallType	TimeZone
EBD	PenWinWarning	Uninstall (with
Express	ProductID	BackupDir)
InstallDir	SaveSUBoot	Verify
		VRC

[System] parameters:

Display	Machine	PenWindows
DisplChar	Monitor	Power
Keyboard	Mouse	Tablet
Locale		

[NameAndOrg] parameters:

Name	Org	Display
------	-----	---------

[InstallLocationsMRU] parameters: List of paths**[OptionalComponents] parameters:** List of descriptions**[Printers] parameters:** Printers to install**Network-Related Parameters****[Network] parameters:**

Clients	HDBoot	RPLSetup
ComputerName	IgnoreDetectedNetcards	Services
Description	NetCards	Security
DefaultProtocol	PassThroughAgent	ValidateNetcardResourc
Display	Protocols	es
DisplayWorkstationSet	RemoveBinding	Workgroup
up		WorkstationSetup

[netcard_ID] parameters: Values from the INF file for the network adapter

[MSTCP] parameters:

DHCP	Gateways	PrimaryWINS
DNS	Hostname	ScopeID
DNSServers	IPAddress	SecondaryWINS
Domain	IPMask	WINS
DomainOrder	LMHostPath	

[NWLink] parameters: Frame_Type NetBIOS

[NWRedir] parameters: FirstNetDrive ProcessLoginScript
PreferredServer SearchMode

[NWServer] parameters: BrowseMaster Use_SAP

[VRedir] parameters: LogonDomain ValidatedLogon

[VServer] parameters: LMAnnounce MaintainServerList

The setup script parameters are not case-sensitive. They are also not required; if they don't appear in a setup script, Windows 95 Setup just uses default values.

Display of most Setup dialog boxes can be disabled in the setup script so that users cannot change any setting. If the dialog boxes are not disabled, sources of information for parameters are given the following priority:

- Information specified in the setup script
- User input
- Detection information

In this section, the descriptions for an option can contain any of six possible entries, as described in the following table. For an example of the resulting file, see [MSBATCH.INF Sample File](#).

Entry	Description
Parameter	The name of the parameter as it appears in a setup script
Values	The values that can be assigned to the parameter and what they mean
System policy	The name of the corresponding parameter for this entry in System Policy Editor; if no entry appears, there is no system policy
Default	The built-in value that is used if no other value is provided

MSBATCH.INF Parameters
Setup Script Parameters

[Setup]

This section sets parameters for control of the Setup process.

Device Path

This parameter specifies whether Windows 95 should check a source installation path to find INF files, rather than looking only in the Windows INF directory when installing devices. If this parameter is set to 1, network administrators can later add INF files to a single source location to ensure that up-to-date drivers are installed any time a new device is installed on computers running Windows 95. However, set this value to 1 only if the installation source files are in a network directory (not floppy disks or CD).

Notice also that **Devicepath=1** causes the entire INF database to be rebuilt each time a user changes a network component or changes drivers for any device.

Parameter	Devicepath
Values	0 = Do not add a source directory path for INFs 1 = Add the installation source directory to the path for finding INFs
Default	0

Emergency Startup Disk

This parameter specifies whether to create the emergency Startup Disk during Setup (the command-line override for this is **/ie**). For a setup script intended for hands-free installation, you might want to specify **ebd=0** so that the user isn't prompted to insert or remove the floppy disk. If you need to specify **ebd=1**, you can also add a **reboot=0** entry, so that Setup will not attempt to restart the computer while the floppy disk is in the drive.

Parameter	EBD
Values	0 = Do not create an emergency Startup Disk 1 = Create an emergency Startup Disk
Default	1

Express

This parameter specifies whether the user can provide input during Setup. If **express=1**, then Windows 95 Setup uses only the settings specified in MSBATCH.INF or built-in defaults and does not ask the user to confirm or enter input. This setting disables most of the user interface for Setup.

Parameter	Express
-----------	---------

Values 0 = Allow user input
 1 = Run Setup using only values in MSBATCH.INF
Default 0

Install Type

This parameter specifies the type of installation for Windows 95 Setup.

Parameter InstallType
Values 0 = Compact
 1 = Typical
 2 = Portable
 3 = Custom
Default 1

Installation Directory

This parameter specifies the directory where Windows 95 is to be installed or, for shared installations, the machine directory.

Parameter InstallDir
Values Directory name
Default Windows directory, if present

Pen Windows Warning

This parameter specifies whether to display a warning if an unknown version of Pen Windows is installed.

Parameter PenWinWarning
Values 0 = Do not display the warning
 1 = Display the warning
Default 1

Product ID

This parameter specifies the product ID for your site, which is printed on the Windows 95 compact disc or your Certification of Authenticity.

Parameter ProductID
Values string
Default none

Save SUBOOT Directory

This parameter specifies whether to save the SUBOOT directory for Server-based Setup.

Parameter SaveSuBoot
Values 0 = Delete SUBoot directory
 1 = Save directory
Default 0

Time Zone

This parameter specifies the time zone to set on the computer.

Parameter TimeZone
Values String enclosed in quotation marks, as described in the following list
Default The time zone currently set on the computer

Time zone strings

Afghanistan	Czech	Israel	Samoa
Alaskan	Dateline	Lisbon Warsaw	Saudi Arabia
Arabian	E. Europe	Mexico	South Africa
Atlantic	E. South America	Mid-Atlantic	Sydney
AUS Central	Eastern	Mountain	Taipei
Azores	Egypt	New Zealand	Tasmania
Bangkok	Fiji	Newfoundland	Tokyo
Canada	GFT	Pacific	US Eastern
Central	GMT	Romance	US Mountain
Cen.	Greenwich	Russian	W. Europe
Australia	Hawaiian	SA Eastern	West Asia
Central	India	SA Pacific	West Pacific
Central Asia	Iran	SA Western	
Central			
Pacific			
China			

Uninstall

This parameter is used to specify whether Setup should create a compressed backup version of the existing Windows and MS-DOS directories to be used for automatically uninstalling Windows 95. If you specify **Uninstall=5**, you also must add a value for **BackupDir=path** that specifies the directory where Setup should place the compressed backup files.

Parameter	Uninstall
Values	0 = Do not allow user to specify Uninstall options, and do not create backup files for uninstalling Windows 95 1 = Show Uninstall options for user to choose 5 = Do not show Uninstall options, but automatically create backup files for uninstalling Windows 95
Default	1

Verify

This parameter, provided principally for use by OEMs, specifies whether to run Setup in Verify mode.

Caution This parameter is not the same as the MS-DOS **verify** command. Most users should not include this entry in a setup script. Setting **Verify=1** will prevent Uninstall in all cases — even if **Uninstall=5** in the setup script.

Parameter	Verify
Values	0 = Do a full installation 1 = Run Windows 95 Setup in Verify mode
Default	0

Version Checking

This parameter defines whether Windows 95 Setup will overwrite existing files automatically, even if the date of the local copy is later than the date for the file in the distribution source.

Parameter	VRC
Values	0 = Prompt user to confirm before overwriting more recent files 1 = Overwrite all without prompting for confirmation
Default	0

MSBATCH.INF Parameters
Setup Script Parameters

[System]

This section sets parameters for modifying the system settings.

Tip The correct entries for MSBATCH.INF can be copied from similarly named entries in SETUPLOG.TXT for a computer on which Windows 95 has been installed with devices identical to those that you want to install from a setup script.

The following entries are based on INF section names:

- **Locale**=*INF_section_name* in LOCALE.INF (see also [International Windows 95](#))
- **Machine**=*INF_section_name* in MACHINE.INF
- **PenWindows**=*INF_section_name* in PENWIN.INF
- **Power**=*INF_section_name* in MACHINE.INF or similar file (for advanced power management support)
- **Tablet**=*INF_section_name* in PENDRV.INF or similar file

The following entries use INF descriptions. The choice must be in the list of compatible devices for that class.

- **Display**=*INF_description* in MSDISP.INF or a similar file
For example, from the description **%SuperVGA.DriverDesc%=SVGA** for Super VGA, the entry in MSBATCH.INF would be **display=svga**.
- **Keyboard**=*INF_description* in KEYBOARD.INF
- **Monitor**=*INF_section_name* in MONITOR.INF
- **Mouse**=*INF_section_name* in MSMOUSE.INF or a similar INF file
- **SelectedKeyboard**=*INF_section_name* in MULTILNG.INF (specifies the keyboard layout)

Caution If **Express=1**, you cannot add parameters to override safe detection for network adapters, SCSI controllers, or sound cards. This means that if the software detection process in Setup does not find peripheral hardware that is actually installed on the computer, then Setup will not run hardware detection to install support. In such cases, the user will have to use the Add New Hardware option in Control Panel to install support after Setup is complete.

You can force installation of certain hardware when **Express=1** by adding specific entries in the [System] section to install support. Otherwise, specify **Express=0** in MSBATCH.INF, and then during Setup you can manually specify hardware detection in the Analyzing Your Hardware dialog box.

Display Characteristics

This parameter sets the initial display characteristics.

Parameter	DisplChar
Values	<i>ColorDepth</i> , <i>x</i> , <i>y</i> where: <i>ColorDepth</i> =bits per pixel <i>x</i> = horizontal resolution <i>y</i> = vertical resolution
Default	4,640,480

MultiLanguage

This parameter sets the type of multilanguage support installed for Windows 95.

Parameter	MultiLanguage
Values	English = Installs support for English and Western European languages

Greek = Adds additional support for Greek
Cyrillic = Adds additional support for Cyrillic
CE = Adds additional support for Eastern European languages

Default English

MSBATCH.INF Parameters

Setup Script Parameters

[NameAndOrg]

This section defines the name and organization for Windows 95 Setup, and specifies whether the user is to be shown the Name and Organization dialog box.

Name

This parameter specifies the full user name for this installation.

Parameter Name
Values String
Default None

Organization

This parameter specifies the registered organization for this installation.

Parameter Org
Values String
Default None

Display

This parameter specifies whether the Name and Organization dialog box appears during Windows 95 Setup.

Parameter Display
Values 0 = Do not display name and organization
1 = Display name and organization
Default 1

MSBATCH.INF Parameters

Setup Script Parameters

[InstallLocationsMRU]

This section specifies the paths to add to the list of directories that the user can choose when Windows 95 Setup prompts for a path. For example, this section could appear as follows to specify local and network file locations:

```
[InstallLocationsMRU]
mru1=a:\
mru2=c:\
mru3=\\winserver\source
```

To force the path for files from which to copy, use **CopyFile=** and related statements in an [Install] section and specify the complete path for the component files.

MSBATCH.INF Parameters

Setup Script Parameters

[OptionalComponents]

This section contains the descriptions that appear in the Optional Components dialog box in Windows 95 Setup.

To create entries for this section, type the description enclosed in quotation marks. Each description is followed by 1 (install) or 0 (do not install). The strings that specify the optional components to install are defined in INF files.

Another way to define entries for this section is to copy the [OptionalComponents] section in SETUPLOG.TXT from a computer that already has all the optional components installed that you want defined in the setup script. For an example, the entries to install Briefcase and Net Watcher are as follows:

```
[OptionalComponents]
"Briefcase"=1
"Net Watcher"=1
```

The following lists show the strings for the optional components defined in the Windows 95 standard INF files. Additional strings can be defined by other application developers.

Optional Component Strings

Accessibility Options	Document Templates	Online User's Guide
Accessories	Flying Through Space	Paint
Audio Compression	Games	Phone Dialer
Backup	HyperTerminal	Quick View
Blank Screen	Jungle Sound Scheme	Robotz Sound Scheme
Briefcase	Media Player	Sample Sounds
Calculator	Microsoft Exchange	Screen Savers
CD Player	Microsoft Fax	Scrolling Marquee
Character Map	Microsoft Fax Services	Sound Recorder
Clipboard Viewer	Microsoft Fax Viewer	System Monitor
Communications	Microsoft Mail Services	System Resource Meter
Curves and Colors	Mouse Pointers	The Microsoft Network
Defrag	Multimedia	Utopia Sound Scheme
Desktop Wallpaper	Musica Sound Scheme	Video Compression
Dial-Up Networking	Mystify Your Mind	Volume Control
Direct Cable	Net Watcher	Windows 95 Tour
Connection	Object Packager	WordPad
Disk compression tools		
Disk Tools		

MSBATCH.INF Parameters

Setup Script Parameters

[Network]

This section specifies the parameters and options for installing networking components. The categories for these parameters include the following:

- Installation parameters
- Computer identification parameters
- Shared installation parameters
- Security parameters
- User interface options

MSBATCH.INF Parameters
Setup Script Parameters
[Network]

Installation Parameters in [Network]

Clients

This parameter specifies the network clients to be installed. It is a list of the device IDs used in the INF files. These IDs are not limited to those in the Windows 95 INF files (NETCLI.INF and NETCLI3.INF). A site that has an INF file from another vendor can use any device IDs listed in it. However, if you are installing a client other than those listed in the INF files provided with Windows 95, you need to obtain an updated Windows 95 INF file from your vendor.

If you are installing multiple clients, the first client in this list will start first whenever the computer is started.

Specify multiple networks in a comma-separated list. If the list contains two network clients, or lists multiple networks with a primary-only network (such as IBM® OS/2® LAN Server), Windows 95 Setup presents an error message and displays the Network Configuration properties for changing the selection. The verification process that occurs in Setup still takes place.

Parameter	Clients
Values	Comma-separated list of client device IDs (see the following table)
Default	Defaults in NETDEF.INF

The following table shows the valid device IDs for network clients as specified in NETCLI.INF and NETCLI3.INF (which are Windows 95 INF files).

Device ID	Network
lant5	Artisoft® LANtastic® version 5.x and 6.x
network3	Novell® NetWare® version 3.x
network4	Novell NetWare version 4.x
nwredir	Microsoft Client for NetWare Networks
pcnfs50	SunSoft® PC-NFS® version 5.x and greater
vines552	Banyan® VINES® version 5.52 and greater
vredir	Client for Microsoft Networks

Network Card Drivers

This parameter specifies the drivers to be installed for network adapters as a list of the device IDs used in the INF files. These IDs are not limited to those included in the Windows 95 INF files. A site that has an INF file from another vendor can use any device IDs listed in that file.

Important In general, it is recommended that you rely on detection in Windows 95 Setup to install the correct driver and define the correct configuration settings.

When a network adapter is listed, the usual verification takes place. Windows 95 Setup chooses an NDIS 3.1 driver, if available; otherwise, it uses an NDIS 2.x driver.

Parameter	NetCards
Values	Comma-separated list of network adapter device IDs
Default	Results of detection

For example, the following entries would install drivers for Intel® EtherExpress™ 16 or 16TP plus 3Com EtherLink II or IITP:

```
netcards=*PNP812D,*PNP80F3
```

Ignore Detected NetCards

This parameter specifies whether Setup will use the detected information to configure network adapters or use values specified by the **netcards=** parameter in the setup script.

Parameter IgnoreDetectedNetCards
Values 0 = Do not ignore detected adapters
1 = Ignore the detected network adapters and use the values specified for **NetCards=deviceID**
Default 0

Protocols

This parameter specifies the protocols to be installed as a list of the device IDs used in the INF files. These IDs are not limited to those in the Windows 95 INF files. A site that has an INF file from another vendor can use any device IDs listed in that file.

Note If you are installing a protocol other than those listed in the INF files provided with Windows 95, you need to get an updated Windows 95 INF file from your vendor.

Setup verifies these settings, so it is possible to specify only the network clients and let Windows 95 Setup choose the protocols. For example, if you specify **Clients=pcnfs50**, then Windows 95 Setup adds NFSLINK.

Parameter Protocols
Values Comma-separated list of protocol device IDs, as described in the following table
Default Defaults in NETDEF.INF

The valid device IDs for protocols in the Windows 95 INF file (NETTRANS.INF) are the following.

Device ID	Protocol
dec40	DECnet™ version 4.1 Ethernet protocol
dec40t	DECnet version 4.1 token ring protocol
dec50	DECnet version 5.0a Ethernet protocol
dec50t	DECnet version 5.0a token ring protocol
ipxodi	Novell-supplied IPXODI protocol
msdlc	Microsoft DLC (real mode)
mstcp	Microsoft TCP/IP
ndisban	Banyan VINES NDIS Ethernet protocol
ndtokban	Banyan VINES NDIS token-ring protocol
netbeui	Microsoft NetBEUI
nfslink	Sun PC-NFS protocol
nwlink	IPX/SPX-compatible protocol
nwnblink	NetBIOS support for IPX/SPX-compatible protocol

Default Protocol

This parameter sets the default protocol (which is assigned LANA 0), which is the specified protocol bound to the specified network adapter (if the computer has more than one network adapter). If no adapter is specified, the default is the first instance of the specified protocol. Set this value if, for example, the computer will run software that requires a protocol to be bound to LAN adapter (LANA) 0, which can only be defined by setting that protocol as the default protocol. For more information about LAN adapter numbers, see [Network Technical Discussion](#).

If **netbios=1**, you must set **defaultprotocol=nwnblink** if you want to specify IPX/SPX-compatible protocol as the default.

Parameter DefaultProtocol

Values A protocol device ID as defined in **protocol=** and, optionally, a network adapter device ID, as defined in **netcards=**.

Default 0

The following example sets the default protocol as an instance of NetBEUI bound to a particular adapter:

```
DefaultProtocol=netbeui,*pnp812d
```

Remove Binding

This parameter removes the binding between the two devices. This parameter is used to tune bindings in a setup script.

Parameter RemoveBinding

Values Comma-separated list of device IDs

Default None

Services

This parameter specifies the network services to be installed as a list of the device IDs used in the INF files. These IDs are not limited to those in the Windows 95 INF files. A site that has an INF file from another vendor can use any device IDs listed in that file. When a service is listed in a setup script, the usual verification still takes place.

The only service installed by default is VSERVER (File and Printer Sharing for Microsoft Networks) if peer sharing services were enabled for Windows for Workgroups.

Parameter Services

Values Comma-separated list of service device IDs, as described in the following table

Default Windows 95 Setup defaults, depending on the value of **InstallType**

The following shows the valid device IDs defined in several different INF files.

Device ID	Service	INF file
bkupagnt	Arcada® Backup Exec agent	BKUPAGNT.INF
cheyagnt	Cheyenne® ARCserve agent	CHEYENNE.INF
jadm	HP® Network Printer service for Microsoft	HPNETPRN.INF
janw	HP Network Printer service for NetWare	HPNETPRN.INF
nmagent	Microsoft Network Monitor agent ¹	NMAGENT.INF
nwserver	File and Printer Sharing for NetWare Networks	NETSRVR.INF
pserver	Microsoft Print Service for NetWare Networks ¹	MSPSRV.INF
remotereg	Microsoft Remote Registry service ¹	REGSRV.INF
snmp	Microsoft SNMP agent ¹	SNMP.INF
vserver	File and Printer Sharing for Microsoft Networks	NETSRVR.INF

¹ Available in the ADMIN directory of the Windows 95 compact disc.

For information about using the INFINST utility to set up files from the ADMIN directory on the Windows 95 compact disc for installation from a network directory, see [Custom, Automated, and Push Installations](#).

MSBATCH.INF Parameters
Setup Script Parameters
[Network]

Computer Identification Parameters in [Network]

Computer Name

This parameter sets the computer's network name.

Parameter ComputerName
Values String of up to 15 alphanumeric characters and no blank spaces. The name must be unique on the network and can contain the following special characters:
 ! @ # \$ % ^ & () - _ ' { } . ~
Default Generated from the first eight characters of the user name

Description

This parameter is the description for the computer (mainly used by peer servers such as File and Printer Sharing for Microsoft Networks).

Parameter Description
Values 48 characters long, containing no commas
Default User name from licensing information

Workgroup

This parameter sets the workgroup for the computer.

Parameter Workgroup
Values String of up to 15 alphanumeric characters and no blank spaces. The name must be unique on the network and can contain the following special characters:
 ! @ # \$ % ^ & () - _ ' { } . ~
System policy Workgroup settings (under policies for Microsoft Client for Windows Networks)
Default Workgroup previously specified; otherwise, a new name is generated from user licensing information by taking the first 15 characters of the organization name. For example, an organization name of "Microsoft Corporation" results in "MicrosoftCorpo" as the default workgroup.

MSBATCH.INF Parameters
Setup Script Parameters
[Network]

Shared Installation Parameters in [Network]

Hard Disk Boot

This parameter specifies whether, for a client computer running a shared copy of Windows 95 from a server, Setup should configure Windows 95 so that it starts from the hard disk but runs from a shared network copy.

Parameter HDBoot
Values 0 = Start from the server or floppy disk if **WorkstationSetup=1**
 1 = Start from the hard disk and run from the network
Default 0

The following table shows the settings for this parameter and the RPLSetup parameter, depending on how the computer runs Windows 95.

Windows 95 location	HDBoot	RPLSetup
Hard-disk boot, Windows 95 on a server	1	0
Floppy-disk boot, Windows 95 on a server	0	0
Remote boot, Windows 95 on a server	0	1

Remote-Boot (RPL) Setup

This parameter specifies that Setup should create a disk image on the network server for a remote-boot workstation during Workstation Setup. This parameter is ignored if a corresponding Workstation Setup value is not defined. (Therefore, setting **RPLSetup=1** does not automatically set **WorkstationSetup=1**.)

Parameter	RPLSetup
Values	0 = Don't do a remote-boot setup 1 = Do a remote-boot setup if WorkstationSetup=1
Default	0

Workstation Setup

This parameter specifies whether Setup configures a client computer to run Windows 95 locally or as a shared copy from a server. If this parameter is set to No (0), Windows 95 Setup runs normally. If this parameter is set to Allow (1) and if Setup is running from a server, Setup asks if the user wants to install Windows 95 as a shared copy or on the local hard disk. For more information, see [Server-Based Setup for Windows 95](#). See also the table for the **HDBoot** parameter earlier in this section.

Parameter	WorkstationSetup
Values	0 = Allow a standard setup (local files) 1 = Allow a shared workstation setup (run from a server)
Default	0

Display Workstation Setup

This parameter specifies whether the Setup user interface appears during installation of Windows 95 on a workstation that will run a shared copy of Windows 95. Setting this value to 0 forces the value defined for **WorkstationSetup** in the script.

Parameter	DisplayWorkstationSetup
Values	0 = Do not display user interface 1 = Display user interface
Default	0

MSBATCH.INF Parameters
Setup Script Parameters
[Network]

Security Parameters in [Network]

User Security

This parameter specifies the security model to be used and, for user-level security, the type of pass-through agent (that is, server or domain). A client with a security provider must be installed for these values to have an effect.

Parameter	Security
Values	share = share-level security nwserver = user-level security, validated by a NetWare server

domain = user-level security, validated by a Windows NT domain
msserver = user-level security, validated by a computer running Windows NT Workstation

System policy User-level Access Control settings (under policies for Access Control)
Default share

Pass-Through Agent

This parameter specifies the pass-through agent for user-level security. This value is ignored in share-level security.

Parameter PassThroughAgent
Values Server or domain name
System policy User-level Access Control settings (under policies for Access Control)
Default No value, or the value of **Workgroup** if **Security=domain**, **Preferred Server** if **Security=nwserver**, or none. The default is the value of **PreferredServer** if **Security=nwserver**; otherwise, there is no default.

MSBATCH.INF Parameters
Setup Script Parameters
[Network]

User Interface Options for [Network] Parameters

Display

This parameter controls whether any of the Network Configuration dialog boxes appear in Custom Setup.

Parameter Display
Values 0 = Do not display
 1 = Display
Default 1

Validate NetCard Resources

This parameter specifies whether to display a dialog box to resolve resource conflicts if a partial configuration is detected or if there is an IRQ conflict for a network adapter.

Parameter ValidateNetCardResources
Values 0 = Do not display a wizard page
 1 = Display a wizard page to resolve resource conflicts
Default 1

MSBATCH.INF Parameters
Setup Script Parameters
[netcard_ID]

The actual name for this section is the identifier for the network adapter, as defined in the related INF file. This section sets parameters for a specific network adapter, as defined in the [netcard.NDI] sections of the network device INF files provided with Windows 95.

Important In general, it is recommended that you rely on detection in Windows 95 Setup to install

the correct driver and define the correct configuration settings.

All entries for a *[netcard_ID]* section depend on the specific adapter. The actual parameters and settings for a specific network adapter can be found in that adapter's INF file in the Windows INF directory.

To locate settings for a network adapter, check NET.INF for entries such as the following:

```
CardBrand=brand of network adapter  
INFFile=file where these settings can be found
```

In the related INF file for the specific network adapter, search for the adapter's name. For example, you might find the following entry for an Intel EtherExpress 16 network adapter:

```
;*****  
; *PNP812D Intel Etherexpress 16 or 16TP  
;*****
```

The information in the *netcard*.INF file is followed by the specific settings, using this format:

```
; netcard model name  
[adapter.NDI]  
actual settings for adapter
```

For example, for the adapter in the previous example, the following entry appears in the NETEE16.INF file:

```
[*PNP812D.ndi]  
AddReg=*pnp812d.ndi.reg,EXP16.ndi.reg
```

Based on the **AddReg=** entry in this statement, you need to search for the [*pnp812d.ndi.reg] or [EXP16.ndi.reg] sections in the INF file to find the parameters required for a particular adapter. For example, for the related Intel EtherExpress adapter, the following sections appear in NETEE16.INF:

```
[*PNP812D.ndi.reg]  
.br/>.br/>HKR,NDI\params\Interrupt, resc,1,04,00,00,00  
HKR,NDI\params\IOAddress, resc,1,02,00,00,0  
HKR,NDI\params\DMAChannel, ParamDesc, , "DMA Channel"
```

These entries describe the parameters that can be specified for the adapter in a setup script. Further, in this same part of the *netcard*.INF file, the statements also indicate the kinds and ranges of values that can be specified for a particular parameter. For example, in NETEE16.INF, the following statements indicate that for **DMAChannel=** you must specify an integer in the range of 1-3, where the default value is 1:

```
HKR,NDI\params\DMAChannel,type,,int  
HKR,NDI\params\DMAChannel,default,,1  
HKR,NDI\params\DMAChannel,min,,1  
HKR,NDI\params\DMAChannel,max,,3
```

The following entry in NETEE16.INF indicates that for **Transceiver=** you can specify the values **external** or **onboard** (based on the first string that appears after the **enum** item):

```
HKR,NDI\params\Transceiver,default,,onboard  
HKR,NDI\params\Transceiver,type,,enum  
HKR,NDI\params\Transceiver,enum,external,,external  
HKR,NDI\params\Transceiver,enum,onboard,,onboard
```

Based on the previous examples, the following shows an example of the *[netcard]* section you would add to MSBATCH.INF to set parameters for an Intel EtherExpress 16 or 16TP network adapter:

```
[*PNP812D]  
Interrupt=  
IOAddress=  
DMAChannel=2  
Transceiver=external
```

Notice that you only need to set values for the parameters where you do not want to use the defaults. For a list of possible parameters for some common network adapters, see [Windows 95 Network Adapter INF Summary](#).

MSBATCH.INF Parameters

Setup Script Parameters

[MSTCP]

This section sets parameters for Microsoft TCP/IP. For more information about TCP/IP, see [Network Technical Discussion](#).

DHCP

This parameter specifies whether TCP/IP is configured to use DHCP for dynamic TCP/IP configuration.

Parameter DHCP

Values 0 = Don't enable DHCP
1 = Enable DHCP

Default 1

DNS

This parameter enables DNS name resolution. You must also set **DNS=1** if you plan to use LMHOSTS for name resolution.

Parameter DNS

Values 0 = Disable DNS
1 = Enable DNS

Default 0

DNS Servers

This parameter is a list of the DNS servers to use in the order to try them.

Parameter DNSServers

Values Comma-separated list of DNS server names

Default None

Domain

This parameter sets the DNS domain that this computer is in.

Parameter Domain

Values String

Default None

Domain Order

This parameter sets a list of DNS domains for host name resolution in the order to try them.

Parameter DomainOrder

Values Comma-separated list of DNS domains

Default None

Gateways

This parameter lists the IP gateways (sometimes called IP routers) in the order they are to be used.

Parameter Gateways

Values Comma-separated list of IP addresses

Default None

Hostname

This parameter sets the DNS hostname for this computer (usually the same value as **ComputerName**).

Parameter Hostname
Values String
Default None

IP Address

This parameter sets the computer's IP address if DHCP is not enabled.

Parameter IPAddress
Values Internetwork Protocol (IP) address (###.###.###.###)
Default None

LMHOST File Path

This parameter sets the path and filename of the LMHOST file.

Parameter LMHOSTPath
Values Path
Default None

Primary WINS Server

This parameter sets the primary WINS name server.

Parameter PrimaryWINS
Values IP address (###.###.###.###)
Default None

Secondary WINS Server

This parameter sets the secondary WINS name server.

Parameter SecondaryWINS
Values IP address (###.###.###.###)
Default None

Scope ID

This parameter sets the scope ID.

Parameter ScopeID
Values String
Default None

Subnet Mask

This parameter sets the IP subnet mask for TCP/IP if DHCP is not enabled.

Parameter IPMask
Values IP address (###.###.###.###)
Default None

WINS

This parameter enables WINS for NetBIOS computer name resolution.

Parameter WINS
Values 0 = Disable WINS
1 = Enable WINS resolution
DHCP = Enable WINS but get parameters from DHCP server
Default 1

MSBATCH.INF Parameters
Setup Script Parameters

[NWLink]

The parameters in this section specify settings for the IPX/SPX-compatible protocol and are valid only if **protocols=nwlink** is also specified in the setup script. For more information about these parameters as defined using the Network option in Control Panel, see [Network Technical Discussion](#).

Frame Type

This parameter specifies the default frame type for IPX.

Parameter	Frame_Type	
Values	0 = 802.3	4=Auto
	1 = 802.2	5=Token ring
	2 = Ethernet II	6=Token ring SNAP
Default	4	

NetBIOS

This parameter specifies whether NetBIOS support for IPX/SPX should be installed.

Parameter	NetBIOS
Values	0 = Don't install NWNBLINK 1 = Install NWNBLINK
Default	0

MSBATCH.INF Parameters
Setup Script Parameters

[NWRedir]

For more information about these values for Client for NetWare Networks as specified using the Network option in Control Panel, see [Windows 95 on NetWare Networks](#).

First Network Drive

This parameter specifies the first network drive to which to attach in login scripts for Client for NetWare Networks. This parameter overrides the equivalent setting in NET.CFG.

Parameter	FirstNetDrive
Values	Drive letter ("A" or "A:" are equivalent)
Default	F:

Preferred Server

This parameter specifies the NetWare preferred server. This parameter does not override the equivalent setting in NET.CFG.

Parameter	PreferredServer
Values	String
System policy	Preferred Server settings (under policies for Microsoft Client for NetWare Networks)
Default	None

Process Login Script

This parameter specifies whether login script processing is enabled when running Microsoft Client for NetWare Networks.

Parameter ProcessLoginScript
Values 0 = Disable login script processing
1 = Enable login script processing
Default 1

Search Mode

This parameter specifies the NetWare search mode. The values correspond exactly to the values specified in NET.CFG for Novell NetWare.

Parameter SearchMode
Values 0-7
System Search Mode settings (under policies for Microsoft Client for policy NetWare Networks)
Default 0

MSBATCH.INF Parameters
Setup Script Parameters

[NWServer]

For more information about these values for File and Printer Sharing for NetWare Networks as specified using the Network option in Control Panel, see [Logon, Browsing, and Resource Sharing](#).

Browse Master

This parameter specifies whether a computer configured with File and Printer Sharing for NetWare Networks can be elected browse master.

Parameter BrowseMaster
Values 0 = This computer cannot be a browse master
1 = This computer can be a browse master
2 = This computer is the preferred browse master
Default 1

SAP Browsing

This parameter specifies whether a computer configured with File and Printer Sharing for NetWare Networks uses Server Advertising Protocol (SAP) browsing. Enabling SAP browsing allows a computer with File and Printer Sharing for NetWare Networks to be seen by any NetWare client, but the computer does not appear in a workgroup in Network Neighborhood.

Parameter Use_SAP
Values 0 = Disable SAP browsing (use workgroup style browsing)
1 = Use SAP style browsing
Default 0

MSBATCH.INF Parameters
Setup Script Parameters

[VRedir]

For more information about these values for Client for Microsoft Networks as specified using the Network option in Control Panel, see [Windows 95 on Microsoft Networks](#).

Validated Logon

This parameter specifies whether logons are validated on a Windows NT domain. If you set this value to 1, be sure to specify a value for **LogonDomain**.

Parameter ValidatedLogon
Values 0 = Don't validate logons
1 = Validate logon
Default 0

Logon Domain

This parameter specifies the Windows NT domain to use for logon validation. It can be set even if **ValidatedLogon=0**. If **ValidatedLogon=1**, you must set a correct value for **LogonDomain** to ensure that Windows 95 Setup has access to any required files on a protected network resource, and to ensure that the user can log on successfully when installation is completed.

Parameter LogonDomain
Values String
System Log on to Windows NT settings (under policies for Microsoft policy Client for Windows Networks)
Default Value of **Workgroup** in [Network]

MSBATCH.INF Parameters
Setup Script Parameters

[VServer]

For more information about these values for File and Printer Sharing for Microsoft Networks as specified using the Network option in Control Panel, see [Logon, Browsing, and Resource Sharing](#).

Announce

This parameter specifies whether the computer configured with File and Printer Sharing for Microsoft Networks announces its presence to LAN Manager computers on the network. Setting this value to 1 increases network traffic but makes browsing faster.

Parameter LMAnnounce
Values 0 = Don't announce VSERVER to the network
1 = Announce VSERVER to network
Default 1

Browse Master

This parameter specifies how the computer configured with File and Printer Sharing for Microsoft Networks behaves in a browse master election.

Parameter MaintainServerList
Values 0 = Disabled (this computer cannot be a browse master)
1 = Enabled (this computer is the browse master)
2 = Auto (the computer can be a browse master if required)
Default 2

MSBATCH.INF Parameters
Setup Script Parameters

[Printers]

This section is used to install one or more printers during Setup by specifying a user-defined name for identifying the printer, the model name, and the printer port. Each printer to be installed has a separate entry in this section using the following syntax:

PrinterName=DriverModel,Port

The following restrictions apply:

- The length of the friendly name for the printer name cannot exceed 32 bytes (31 characters plus a NULL character). If the name specified in the custom setup script is too long, Setup will truncate it to fit the requirement.
- The model name must be recognized by Windows 95. You can see the list of supported printer models in the Add Printers wizard or in the printer INF files.
- No commas or quotation marks can be used in any string.

Note If the setup script contains a [Printers] section with no entries, the user will not be asked to select a printer the first time that Windows 95 runs.

Friendly Name

This parameter specifies the friendly name, model, and port for a printer to be installed. The printer's friendly name is the name that appears in the Printers folder. The model name must be the exact name of a printer driver that is supported under Windows 95; otherwise, Setup skips this entire section.

Parameter *PrinterName*= any string that does not contain these characters:

\ , ; =

Values *DriverModel* = The exact driver name for any printer model supported under Windows 95

Port = The port that this printer is attached to (such as LPT1) or a UNC path name to a network print queue

Default None

The following example installs a local printer and a network printer:

```
[Printers]
"My BJC600"="Canon Bubble-Jet BJC-600",LPT1
"IIIsi Next Door"="HP Laserjet IIIsi",\\Server_1\PrtShr_1
```

MSBATCH.INF Parameters

Setup Script Parameters

[Strings]

The [Strings] section defines one or more string keys that Setup expands to the defined string and uses it for further processing. In other sections, a strings key can be used by enclosing it in percent signs (%).

Parameter *String_Key = Value*

Values *String_Key* = A unique name made up of letters and digits.

Value = Letters, digits, or other printable characters. It should be enclosed in quotation marks if the corresponding string key is used in an entry that requires double quotation marks.

The following shows three examples of strings keys:

```
[Strings]
MSFT="Microsoft"
M1="APEX DRIVERS"
DevDesc1=APEX DRIVERS SCSI II Host Adapter
```

MSBATCH.INF Parameters

Setup Script Parameters

[Install]

The [Install] section sets parameters for copying additional files as part of Windows 95 installation. The format for this section is identical to the format for the [Install] section in general INF files, as defined in [Windows 95 INF Files](#).

The following sections provide these examples for using the [Install] section for custom installations:

- Installing custom bitmaps and shortcuts
- Enabling user profiles and remote administration
- Replacing configuration entries

MSBATCH.INF Parameters

Setup Script Parameters

[Install]

[Install] Example: Copying Custom Files

This section describes MSBATCH.INF entries for copying custom files while installing Windows 95. In the following example, custom files are copied for a bitmap file containing a corporate logo plus a shortcut to be placed in Network Neighborhood. These custom files must be created by the administrator and placed with the Windows 95 source files on the network.

```
[install]
```

```
CopyFiles=newfiles.Copy
```

```
[NEWFILES.Copy]
```

```
my_corp.bmp ; bitmap file
```

```
my_link.lnk ; file that contains the shortcut
```

```
[DestinationDirs]
```

```
newfiles.copy=25 ; shared Windows directory
```

The statement in [DestinationDirs] specifies where files are to be copied. Common values include the following for shared installations:

- 10 = machine directory
- 11 = Windows SYSTEM directory
- 25 = Windows directory

Notice that the most flexible means of providing custom links for multiple users is to use system policies. For information about using system policies to create a custom Network Neighborhood or a custom desktop, see [User Profiles and System Policies](#).

MSBATCH.INF Parameters

Setup Script Parameters

[Install]

[Install] Example: Enabling User Profiles and Remote Administration

If you plan to take advantage of user profiles and to allow administration of remote computers, you can enable these capabilities using setup scripts. The following entries are required in MSBATCH.INF to enable these features.

[Install]

AddReg=User.Profiles,Remote.Admin

[User.Profiles]

HKLM,"Network\Logon","UserProfiles",1,1

[Remote.Admin]

HKLM,"Security\Access\Admin\Remote",%Server_Domain_Username%,1,ff,00

[Network]

Security=*domain_or_server* ;enables user-level security

PassThroughAgent=*provider_name*

services=remotereg ;installs the Microsoft Remote Registry agent

[strings]

; specifies the server containing the group or individual account

; to be allowed remote administration capabilities

Server_Domain_Username = "*server_or_domain\account*"



To define the custom values required for enabling remote administration

1. To enable user-level security, set the appropriate values in the [Network] section for **Security=** and **PassThroughAgent=**.

For example, on a NetWare network, if the security provider is a server named NWSVR1:

```
Security=server
```

```
PassThroughAgent=NWSVR1
```

On a Windows NT network, if the security provider is a domain named NTDOM1:

```
Security=Domain
```

```
PassThroughAgent=NTDOM1
```

2. In the [Strings] key, define the value for **%server_domain_username%** to specify the location for the list of user accounts, plus the names of accounts for users who will be allowed remote administration capabilities for this particular computer.

For example, for a NetWare network, the following specifies the server containing the group or individual account, plus the account name to be given remote administration capabilities:

```
Server_Domain_Username = "NWSVR\HELPDESK"
```

For a Windows NT network, the following specifies the domain containing the account, plus the account name to be given remote administration capabilities:

```
Server_Domain_Username = "NTDOM1\ADMIN"
```

Important You must also make sure that the related files supporting Microsoft Remote Registry services are installed with the Windows 95 source files. To do this, use INF Installer, as described in [Custom, Automated, and Push Installations](#).

When you enable remote administration in this way, Setup automatically adds the appropriate Administrators account (including Supervisor and Domain Administrators under Windows NT) to the list of persons or groups allowed to administer the computer remotely, and sets the permissions required

for remote administration.

Enabling user profiles in a setup script is equivalent to selecting the items in the Passwords option in Control Panel named Users Can Customize Their Preferences And Desktop Settings and Include Desktop Icons And Network Neighborhood Settings.



To enable group policies

- If you want to enable group policies for both the Client for Microsoft Networks and Client for NetWare networks, add the following entries to MSBATCH.INF:

```
[Install]
Addreg=User.Profiles.Reg, Group.Policies.Reg
Copyfiles=Group.Policies.Copy

[User.Profiles.Reg]
HKLM,Network\Logon,UserProfiles,1,1

[Group.Policies.Reg]
HKLM,Network\Logon,PolicyHandler,, "GROUPOPOL.DLL, ProcessPolicies"
HKLM,System\CurrentControlSet\Services\MSNP32\NetworkProvider,
  GroupFcn,, "GROUPOPOL.DLL, NTGetUserGroups"
HKLM,System\CurrentControlSet\Services\NWNP32\NetworkProvider,
  GroupFcn,, "GROUPOPOL.DLL, NWGetUserGroups"

[Group.Policies.Copy]
grouppol.dll

[DestinationDirs]
Group.Policies.Copy = 11
```

For information about user profiles and group policies, see [User Profiles and System Policies](#). For information about remote administration of a computer's Registry, see [Remote Administration](#).

MSBATCH.INF Parameters

Setup Script Parameters

[Install]

[Install] Example: Replacing Configuration Entries

This section presents some sample entries for replacing entries in configuration files as part of Windows 95 Setup.

Depending on the common network configuration at your site, you may determine that you need to remove a line from one or more configuration files as a global procedure before starting Windows 95 Setup. For example, you may want to use a protected-mode protocol such as Microsoft TCP/IP instead of the real-mode version of TCP/IP currently being using on the target computers. The following kinds of entries can be used to make these changes during the installation process.

Note If you want to remove TSRs when installing Windows 95 on a NetWare network, you should modify the NETDET.INI file rather than making modifications using MSBATCH.INF. For information, see [Windows 95 on NetWare Networks](#).

[Install]

UpdateInis=update_prot.Ini

UpdateCfgSys=Update_config.sys

UpdateAutoBat=Update_autoexec.bat

[Update_prot.Ini]

system.ini,386enh,"device=mytcp.386"

[Update_config.sys]

[Update_autoexec.bat]

MSBATCH.INF Parameters

MSBATCH.INF Sample File

This section shows a sample setup script.

```
[Setup]
Express=0          ; allows user input
InstallType=1     ; Typical Setup
EBD=1             ; create startup disk
InstallDir=C:\WINDOWS
Verify=0
PenWinWarning=1
ProductID=999999999

[NameAndOrg]
Name="User One"
Org="Your Company Name"
Display=1         ; User Information dialog box is displayed

[OptionalComponents]
"Accessories"=1
"Communications"=1
"Disk Tools"=1
"Multimedia"=1
"Screen Savers"=0
"Disk compression tools"=1
"Paint"=1
"HyperTerminal"=1
"Defrag"=1
"Blank Screen"=1
"Scrolling Marquee"=1
"Calculator"=1
"Object Packager"=1
"Backup"=0
"Phone Dialer"=1
"Clipboard Viewer"=0
"Microsoft Fax"=0
"Microsoft Fax Services"=0
"Microsoft Fax Viewer"=0
"Accessibility Options"=0
"The Microsoft Network"=0
"Audio Compression"=0
"Video Compression"=1
"Sound Recorder"=0
"Volume Control"=0
"Media Player"=1
"Microsoft Exchange"=0
"Microsoft Mail Services"=0
"Briefcase"=0
"Document Templates"=1
"WordPad"=1
"Dial-Up Networking"=0
"Direct Cable Connection"=0
"Mouse Pointers"=0
"Windows 95 Tour"=0
"Online User's Guide"=0
"Desktop Wallpaper"=0
"System Monitor"=0
"Net Watcher"=0
"Character Map"=0
```

"Curves and Colors"=0
"Mystify Your Mind"=0
"Flying Through Space"=0
"Games"=0
"Quick View"=0
"Sample Sounds"=0
"Musica Sound Scheme"=0
"Jungle Sound Scheme"=0
"Robotz Sound Scheme"=0
"Utopia Sound Scheme"=0
"CD Player"=0

[System]

"Display"="Tseng Lans ET4000"
"Keyboard"="Standard 101/102-Key or Microsoft Natural Keyboard"
"Machine"="MS_CHICAGO"
"Monitor"="NEC MultiSync 2A"
"Mouse"="Standard Serial Mouse"
"Power"="No APM"
"Locale"="L0409"
"UI Choice"="Win95UI"
"Multilanguage"="English"

[InstallLocationsMRU]

MRU1=C:\WINDOWS
MRU2=C:\User
MRU3=\\win_svr\source files\home_dir

[Network]

Display=0 ; Network Options do not appear in Setup
ComputerName=W95_1
Workgroup=test_group
Description="This is a lab test computer"
Clients=vredir,nwredir
Security=Domain
PassThroughAgent=Test_domain
WorkstationSetup=0 ; not a shared installation of Windows 95
HDBoot=1

[VREDIR]

ValidatedLogon= 1
LogonDomain=test_domain

Windows 95 Network Adapter INF Summary

This section presents details about the settings for common network adapters, as defined in the [netcard.NDI] sections of the INF files provided with Windows 95. Other adapters are also listed; their settings can be found in the appropriate file in the Windows INF directory. The NET.INF file contains the master information for detecting and configuring network adapters. The specific INF files for network adapters include the following:

net3com.inf	netcpq.inf	netnice.inf	netsmc.inf
netamd.inf	netgen.inf	netnovel.inf	netmctr.inf
netflex.inf	nethp.inf	netoli.inf	netcc.inf
netcable.inf	netibm.inf	netppp.inf	nettulip.inf
netdec.inf	netmadge.inf	netprot.inf	netub.inf
netee16.inf	netncr.inf	netracal.inf	netxir.inf

For information about how to find entries for a particular network adapter in an INF file, see [\[netcard_ID\]](#).

3COM

Cardbrand=3COM
INFFile=NET3COM.INF

```
[*PNP80F3]
Interrupt=
IOAddress=
DMACHannel=
MaxTransmits=
DataTransfer=
XmitBufs=
Transceiver=
```

The following adapters also have settings in the file NEC3COM.INF:

3Com EtherLink Plus®	NCR StarCard
3Com EtherLink III®	NCR® WaveLAN AT
NCR Token-Ring 4 Mbs ISA	TokenLink
NCR Token-Ring 16/4 Mbs ISA	

Digital Equipment Corporation

Cardbrand=Digital Equipment Corp.
INFFile= NETDEC.INF

```
;DEC DE201 Etherworks Turbo TP
[*PNP80EB]
Interrupt=
IOAddress=
RamAddress=
MaxMulticasts=
Maxtransmits=
AdapterName=
```

The following adapters also have settings in the file NETDEC.INF:

DEC (DE211) Etherworks® MC/TP	DEC (DE102) Etherworks LC/TP_BNC
DEC (DE212) Etherworks MC/TP_BNC	DEC EE101 (Built-In)
DEC (DE100) Etherworks LC	DECpc 433 WS (Built-In)
DEC (DE200) Etherworks Turbo	DEC Ethernet (All Types)
DEC (DE101) Etherworks LC/TP	DEC (DE210) Etherworks MC

DEC (DE202) Etherworks
Turbo/TP_BNC

IBM

Cardbrand=IBM
INFFile= NETIBM.INF

```
;IBM Token Ring  
[*PNP80C9]  
MaxTransmits=  
Primary  
Alternate=  
RecvBufs=  
XmitBufs=  
MaxPacketSize=  
ProductID=  
NetworkAddress=  
Iobase=  
RecvBufSize=  
XmitBufSize=
```

The following adapters also have settings in the file NETIBM.INF:

IBM Token Ring 4/16Mbps
IBM Token Ring II/Short
IBM Token Ring (All Types)

Intel

Cardbrand=Intel
INFFile= NETEE16.INF

```
;Intel Etherexpress 16 or 16TP  
[*PNP812]  
IOBaseAddress=  
IRQ=  
IOAddress=  
Transceiver=  
IOChrdy=  
IOChannelReady=
```

The following adapters also have settings in the file NETEE16.INF:

Intel EtherExpress PRO
Generic 595
Intel EtherExpress 16 (MCA)

MADGE

Cardbrand=MADGE
INFFile= NETMADGE.INF

```
;Madge Networks Smart 16/4 PC Ringnode  
[*PNP81D7]  
RxTxSlots=  
NetworkAddress=  
MaxFrameSize=  
RxBufferSize=  
TxBufferSize=  
MaxTransmits=  
Watchdog=  
CopyAllData=
```

AutoOpen=
OpenOptions=
NoMmio=
PromiscuousModeX=

[MadgeISA]
IrqNumber=
IOAddress=
MemBase=
DMAChannel=

The following adapters also have settings in the file NETMADGE.INF:

Madge Networks Smart 16/4 Ringnode (All ISA Types)
Madge Networks Smart 16/4 AT/P Ringnode
Madge Networks Smart 16/4 AT Ringnode
Madge Networks Smart 16/4 ISA Client Plus Ringnode
Madge Networks Smart 16 Ringnode

Novell

Cardbrand=Novell
INFFile= NETNOVEL.INF

[ne2000]
InterruptNumber=
IOBaseAddress=
Interrupt=
IOBase=

The following adapters also have settings in the file NETNOVELL.INF:

Artisoft AE-1	National Semiconductor AT/LANTIC
Artisoft AE-2 or AE-3	NE1000 Compatible
Ethernode 16-AT3	Novell Ne2000 Plus
National Semiconductor Ethernode *16AT	Zenith Data Systems NE2000 Compatible

Proteon

Cardbrand=Proteon
INFFile=NETPROT.INF

;Proteon Token Ring (P1392)
[*pnp81eb]
IntLevel=
IOBase=
DMAChannel=
LinkSpeed=
CardSpeed=
Media=
CableType=
DMAClock=
SAEN=
MaxTransmits=
NetworkAddress=

The following adapters also have settings in the file NETPROT.INF:

Proteon ISA Token Ring (1340)	Proteon ISA Token Ring (1347)
Proteon ISA Token Ring (1342)	Proteon Token Ring (P1392+)
Proteon ISA Token Ring (1346)	Proteon Token Ring (P1390)

Racal

Cardbrand=Racal
INFFile= NETRACAL.INF

```
; Racal NI6510
[*pnp8113]
IOBase=
MaxReceives=
MaxTransmits=
MaxMulticasts=
```

The Racal NI5210/8 or NI5210/16 adapter also has settings in the file NETRACAL.INF.

SMC

Cardbrand=SMC
INFFile= NETSMC.INF

```
; SMC9000
[*Smc9000]
Interrupt=
Port_Num=
Xt_Type=
Micro_Channel=
```

The following adapters also have settings in the file NETSMC.INF:

ArcNet Compatible	SMC EtherCard™ adapters
Pure Data PDI508+ (ArcNet)	SMC EtherElite adapters
Pure Data PDI516+ (ArcNet)	SMC StarCard PLUS adapters
SMC® ArcNet adapters	SMC TokenCard Elite

Thomas-Conrad

Cardbrand=Thomas-Conrad
INFFile= NETTCC

```
; Thomas-Conrad (All Arcnet Types)
[*pnp8326]
Interrupt=
IOBase=
MemoryBase=
PacketSize=
```

The following adapters also have settings in the file NETTCC.INF:

TC6045	Thomas-Conrad TC6142
TC6145	Thomas-Conrad TC6242
TC6245	Thomas-Conrad TC4035
Thomas-Conrad TC6042	Thomas-Conrad TC4045

Introduction

This appendix provides information about Microsoft Systems Management Server, which can be used to install and maintain Windows 95 on networked computers.

For more information about Microsoft Systems Management Server, contact your Microsoft sales representative or see the documentation provided with Systems Management Server. For information online, type **go msnet** at any CompuServe® command prompt and choose Section 16; or connect to the Microsoft World Wide Web site at <http://www.microsoft.com> and select BackOffice Information and White Papers.

- [Microsoft Systems Management Server Overview](#)
- [Systems Management Server Requirements](#)
 - [How Systems Management Server Reduces Migration Costs](#)
 - [The Systems Management Server Solution](#)
 - [Systems Management Server Components](#)
- [Systems Management Server Services](#)
 - [Hardware and Software Inventory](#)
 - [Software Distribution and Installation](#)
 - [Managing Shared Applications](#)
 - [Remote Control and Troubleshooting](#)
 - [Network Protocol Analysis](#)
- [Using Systems Management Server to Deploy Windows 95](#)
- [Windows 95 Deployment Procedures](#)

Microsoft Systems Management Server Overview

In a corporate environment where you might have hundreds, or even thousands, of computers, the process of upgrading to Windows 95 can become complex — especially if you want to deploy Windows 95 on all computers at the same time. This appendix discusses how you can use Microsoft Systems Management Server to automate the large-scale deployment of Windows 95, making the upgrade process faster, easier, and less expensive for your organization. It also describes the services offered by Systems Management Server for centralized management of computers in an enterprise network, including inventory, software distribution and installation, management of shared applications, remote management and troubleshooting, and network protocol analysis.

Systems Management Server organizes computers into a hierarchy of sites. A site is a group of servers and client computers typically located in a single geographical area. A site can consist of one or more domains (that is, a set of servers and clients that are managed as a group) existing on the same LAN.

Systems Management Server uses the terms central, primary, and secondary to identify the capabilities of sites in the hierarchy. A central site is a primary site at the top of the hierarchy, from which all sites and computers in the hierarchy can be administered.

A primary site has its own Microsoft SQL Server™ database, which contains all of the hardware and software inventory information for the site and its subsites (sites attached below it in the hierarchy). The primary site can run the Systems Management Server Administrator tool for local administration of the site server and all subsites. A primary site must be running Windows NT Server.

A secondary site is a site that does not have a SQL Server database or the Systems Management Server Administrator tool. This site is administered from any site above it in the hierarchy and has no subsites. A secondary site must be running Windows NT Server.

A primary site can have either secondary sites or other primary sites beneath it in the hierarchy. A secondary site must have a primary site above it and can have no sites below it.

The following figure illustrates a sample Systems Management Server hierarchy. The hierarchical site structure is depicted on the administration console, so that you can easily identify a computer based on its location.

Systems Management Server Requirements

The following lists the basic requirements for using Microsoft Systems Management Server:

- Windows NT Server version 3.5 or later
- Microsoft SQL Server version 4.21 or later
- A 486/66 or better processor
- 32 MB of memory (recommended)
- A hard disk with at least 100 MB available
- A network-accessible CD-ROM drive
- A network adapter
- A Microsoft Mouse or compatible pointing device (a mouse is recommended but optional)

Microsoft Systems Management Server supports the following connection protocols, networking options, and clients.

Supported Protocols, Clients, and Networks

Connection protocols:

Asynchronous	Remote Access Service (RAS)
IPX/SPX	SNA
ISDN	TCP/IP
NetBEUI	X.25

Clients:

Apple® Macintosh® System 7™	MS-DOS 5.0 or later
DEC Ultrix™	Sun® Solaris
DEC VMS™	Windows 3.1 or later
HP-UX®	Windows NT 3.1 or later
IBM AIX®	Windows for Workgroups 3.11 or later
IBM OS/2® version 1.x or 2.x	Windows 95

Networks:

DEC™ PATHWORKS™	Novell® NetWare® 3.x or 4.x (in 3.x compatibility mode)
IBM® LAN Server 3.x	
LAN Manager 2.1 or later	Windows NT Server

The following table lists the typical requirements for sites in a Systems Management Server hierarchy, based on an installation of up to 1000 computers. These requirements are grouped according to how each server is used. Notice that all of the servers must be running Windows NT Server. Systems Management Server requires a Windows NT file system (NTFS) partition.

Systems Management Server Servers

Processor and server type	RAM	Disk space	Recommendations
---------------------------	-----	------------	-----------------

Central site server:

Intel® 486/66	32-96	1 GB	A high-performance computer is recommended due to the heavy load placed on the central-site computer by Microsoft Systems Management Server and SQL Server.
Intel Pentium	MB		
DEC Alpha			
MIPS® R4000™			

Primary or secondary site:

Intel 486/66	24 MB	100 MB	28 MB of RAM is required if SQL Server is on the same computer as the primary-site server.
Intel Pentium		40 MB	
DEC Alpha			
MIPS R4000			

SQL Server:

Intel 486/66
Intel Pentium
DEC Alpha
MIPS R4000

20 MB

28 MB of RAM is required if SQL Server is on the same computer as the primary-site server. Storage requirements depend on the size of the installation.

Systems Management Server Clients**Processor and operating system****RAM****Disk space****Recommendations**

Intel x86
Windows 3.x,
Windows for
Workgroups, MS-
DOS 5.x or greater

4 MB

100 MB

Client components require 4.5 MB of storage and 7 KB of conventional memory.

68040 PowerPC™
Macintosh System
7.x

16 MB

80 MB

Client components require 3 MB of storage.

How Systems Management Server Reduces Migration Costs

A recent survey by the Gartner Group estimates that the cost per computer to upgrade to Windows 95 will be between \$250 (best case) and \$750 (worst case). The primary difference between the best-case and worst-case scenarios is in the amount of advance planning and the level of automation of the installation, showing that time spent on planning pays off.

According to Gartner Group estimates, using Systems Management Server could affect the time required for installation, technical support, and administrative tasks, moving all of them toward the "Best Case" column shown in the following table. Your actual savings will depend on the number of computers you are upgrading and the price you pay for labor.

Estimated Windows 95 Migration Time with Systems Management Server

Task	Best Case (hours per computer)	Worst Case (hours per computer)
Installation		
Technician travel time	0.10	0.50
Backing up hard disk	0.10	0.75
Hard disk housekeeping	0.20	1.00
Installation of Windows 95	0.20	1.00
Testing of new configuration	0.10	0.50
Technical Support		
Help desk calls	0.17	0.50
Tier-2 support calls	0.33	0.67
Peer-support calls	0.17	0.33
User disruption	1.00	2.00
Administrative tasks		
Filling out forms	0.00	0.50
Updating inventory system	0.00	1.00
Total time for all tasks	2.37	8.75
Hours saved per computer	6.38	

Source: Gartner Group

The Systems Management Server Solution

Systems Management Server is the perfect way to reduce the time, effort, and expense involved in migrating computers running MS-DOS and Windows to Windows 95. The software distribution and installation capabilities of Systems Management Server allow you to automatically distribute and install Windows 95 to all or a selected group of your LAN-based computers.

The immediate benefit that you realize by using Systems Management Server to upgrade to Windows 95 is a substantial reduction in the time required to perform the upgrade, resulting in a reduction in the overall upgrade cost. And, after the upgrade, Systems Management Server continues to save you time and money as you install, inventory, and manage other applications.

Systems Management Server Components

Systems Management Server consists of several Windows NT services and few platform-specific applications. These components communicate with each other by writing information to files that they store in a specific database or directories. Each service or application polls the database or a directory for specific files, and records its results in files destined for the database or the next service. After all services or applications have completed their tasks, the finished product can be a client computer inventory or a successfully installed software package.

Inventory data and Systems Management Server component configurations are stored in a SQL Server database. The database information can be viewed using the Systems Management Server Administrator tool or through other SQL Server front-end tools, such as Microsoft Access.

The following terms describe the roles played by computers in the Systems Management Server system and define how they are structured within the management architecture.

Systems Management Server Terminology

Site Terms:

- | | |
|----------------|---|
| Central Site | This is the highest site in the Systems Management Server architecture. All sites and computers in the hierarchy can be administered from this site. There can be an unlimited number of subsites below the central site. The central site must be a primary site, and have a SQL Server database. The central site must be running Windows NT Server. |
| Primary site | A Systems Management Server site that has its own database, which contains all of the hardware and software inventory information for the site and its subsites. Local administration can be performed for the site server and all the sites below it in the hierarchy. A primary site must be running Windows NT Server. |
| Secondary site | A Systems Management Server site that does not have a SQL Server database or Systems Management Server Administrator tool. This site is administered from any site above it in the hierarchy and does not have subsites. Its site information is reported to the site above it. A secondary site must be running Windows NT Server. |
| Domain | A Systems Management Server domain is a set of servers and client computers that have been grouped together. A domain is primarily used to organize servers and clients into manageable groups and provide logon validation, inventory collection, report generation, and package distribution. Within any one site there is always at least one domain. However, each site can have multiple domains to meet your management requirements. Valid domains are Windows NT, NetWare, LAN Manager, and LAN Server. |

Server Terms:

- | | |
|---------------|---|
| Site server | Each site has at least one site server. A site server is a computer running Windows NT Server that contains Systems Management Server components needed to monitor and manage the site, its domains, and its computers. The site server also serves as a collection point for instructions and inventory information. |
| Helper server | To help ease the load on the site server, you can move some |

of the components from the site server to other servers. These are called helper servers. Because helper servers are used to offload some of the processing from the site server, they must be running Windows NT Server.

SQL Server Each primary site must have a SQL Server. Systems Management Server uses Microsoft SQL Server to store the site database. SQL Server can be installed on the site server or on a separate server. Although each site must have its own database, different sites can share the same SQL Server. It is, however, more efficient for the SQL Server to be on the same LAN as the sites using its databases.

Distribution server This server is used as a distribution point when sending applications for clients to install or run. This means that the system administrator has to send only one copy of the software to each group of computers connected to the distribution server, thus reducing traffic on the network. A distribution server can be a Windows NT Server, a NetWare Server, a LAN Server, or a LAN Manager Server.

Logon server This server is used to validate client computer logons, and functions as a transfer point between clients and site servers. When a computer logs on, the network inventory information is placed onto the logon server, where it is collected by Systems Management Server, and stored in the database. Any supported network server can act as a logon server. For example, a NetWare Server can act as a logon server for its existing client computers.

Notice that it is completely possible within a small Systems Management Server site for the site server to also be the logon server, the distribution server, and the SQL Server.

Systems Management Server Services

This section describes the services provided by Systems Management Server to make it easier to manage computers on the network.

Hardware and software inventory.

Systems Management Server automatically retrieves detailed information about both the hardware and software for every computer within your enterprise and stores the information in a standard SQL Server database. The inventory properties of the computer can include the microprocessor, the various drives, the network adapter, the memory, the IRQ table, and a number of other hardware-related components.

Two types of software inventory information are available. The detailed identification inventory looks for a particular set of files (for example, EXE and DLL files) to verify that all of the required files are present and are valid versions. The comprehensive audit inventory checks the files on the computer's disk against a predefined list of applications. Systems Management Server can also collect copies of the computer's configuration files and add them to an archive. These inventory features are useful for tracking maintenance and planning upgrades.

Software distribution and installation.

Systems Management Server makes it easy to automatically distribute commercial or internally developed applications, upgrades or fixes, or virus-checking software to selected personal computers on the local network and at remote sites. Systems Management Server distributes and installs software in package form. Packages can be used to install software on client computers; packages can also install and share software on a network server, or identify existing software on target computers and collect specified files.

Management of shared applications.

Systems Management Server can control access to shared applications to balance loads and provide fault tolerance and metering. When sharing applications, you can also automatically view a program group tailored to a specific user, no matter which computer the user uses to log on to the network. You determine which network users (or user groups) need access to specific server applications. The server applications database is replicated on all of the logon servers at a site.

Remote control and troubleshooting.

Systems Management Server provides two remote management features: Help Desk and Diagnostics. Help Desk provides direct access to a client (including the ability to carry out commands, transfer files, and restart the computer), allowing you to troubleshoot and support individual remote computers. The Diagnostics utilities allow you to view the current hardware and software configuration of a workstation.

Network protocol analysis.

The Network Monitor component of Systems Management Server is a diagnostic tool that allows you to look at the details of network packets, perform remote captures on a packet anywhere on the network, and gather network statistics about a group of personal computers. It enables you to capture and analyze network traffic and detect connection problems or potential network bottlenecks.

The following publications also provide more information:

- *Microsoft Systems Management Server Administrator's Guide*
- *Microsoft Systems Management Server Resource Kit*
- *Microsoft Systems Management Server Evaluation Guide*
- *Microsoft Systems Management Server Deployment Guide*
- *Microsoft Windows NT Resource Kit*
- *Microsoft SQL Server Resource Kit*

Hardware and Software Inventory

As a systems administrator, you are familiar with the problems associated with determining the number of personal computers that exist in a large distributed enterprise, and keeping track of all of the hardware and software associated with each computer. Systems Management Server helps make these tasks easy and cost-effective.

Systems Management Server can automatically retrieve detailed information about both the hardware and software for every computer within your enterprise and store the information in a standard SQL Server database. You can select, sort, and view the data, or you can query the database, extract the data, and create custom reports with popular desktop applications, such as Microsoft Access or Lotus® 1-2-3®. A few of the business benefits are listed in this section.

Maintenance and service tracking.

Systems Management Server can automatically create an inventory of all computers connected to your network. You can then supplement this information by adding your company asset numbers, the cost of each computer, and any maintenance that has been performed. If you want to install a new adapter—for example, a sound card—you can tell the technician the exact configuration of the computer, to make sure that the device works correctly and minimize computer downtime.

Planning your upgrades.

When planning for the upgrade of all computers in your organization to Windows 95, you can use Systems Management Server to help you identify which computers need new hardware to qualify for the upgrade. All you need to do is define a computer configuration and run a query on the database to find which ones need new hardware.

For hardware inventory, Systems Management Server supports the Desktop Management Interface (DMI). Any hardware vendor can write a Management Information File (MIF) as defined by the DMI, to include their component in the inventory properties of the computer where it resides. Currently-defined components include the microprocessor, the various drives, the network adapter, the memory, the IRQ table, and a number of other hardware-related components. The hardware inventory detects these defined components and stores information about them in the SQL database.

Two types of software inventory information are collected by Systems Management Server: detailed identification and comprehensive audit. As with hardware inventory, both types of software information are stored in the SQL database, which you can query.

A detailed identification inventory looks for a particular set of files. For example, if an accounting system requires a set of EXE and DLL files, detailed identification inventory can verify that all of the required files are present and that they are valid versions. Or, if you want to upgrade to the new version of an application, this type of inventory can tell you how many copies to buy and where to distribute them.

A comprehensive audit is used to determine if specified applications are installed on the network's computers. In this type of inventory, Systems Management Server checks the files on the computer's disk against a list of applications that are predefined in a package rule file. You can add or delete applications from this list to customize it for the enterprise. Microsoft provides a list of most Microsoft applications, and approximately 2500 software packages from leading vendors.

Systems Management Server can also collect software. For example, it can collect copies of the computer's configuration files (such as AUTOEXEC.BAT, CONFIG.SYS, SYSTEM.INI, or WIN.INI) and add them to an archive. If a problem occurs later on a computer, a technician can replace corrupted files or review the files in the archive to see if a change in a configuration file might have caused the problem. This is the ideal way to manage a diverse variety of configuration files.

How Inventory Is Processed

The inventory collection process is as follows:

1. The first time a computer logs on to the network, Systems Management Server installs a program called the Inventory Agent on the computer. This is a management agent that examines the computer to determine the hardware and operating system configuration of the computer, and then builds a binary inventory file (report) of this information.
2. The Inventory Agent places the inventory file on the logon server. During this process, the client computer uses its network logon server. For example, a NetWare client works directly with its existing NetWare server; it doesn't need to access a Windows NT, LAN, or other server.
3. At intervals set by the administrator, the Inventory Agent inspects the computer for hardware and software inventory information.
4. At intervals set by the administrator, the primary site server collects the inventory files from all of its logon servers, determines what inventory changes have taken place since the last inventory, and updates its database with the new information. This changed information is passed all the way up the hierarchy to the central site.

Systems Management Server automatically inventories all hardware and operating system components it can locate, but inventories only the software you specify. To specify which software components Systems Management Server should include in the inventory you create an inventory package.

Microsoft Systems Management Server
Systems Management Server Services
Hardware and Software Inventory

Creating an Inventory Package

To collect software inventory information, you create an inventory package. Systems Management Server automatically sends the package to all primary sites beneath the one where the package was created.



To create a new package, start SMS Administrator and follow these steps:

1. Open the Packages window.
2. In the File menu, select New to display the Package Properties dialog box.

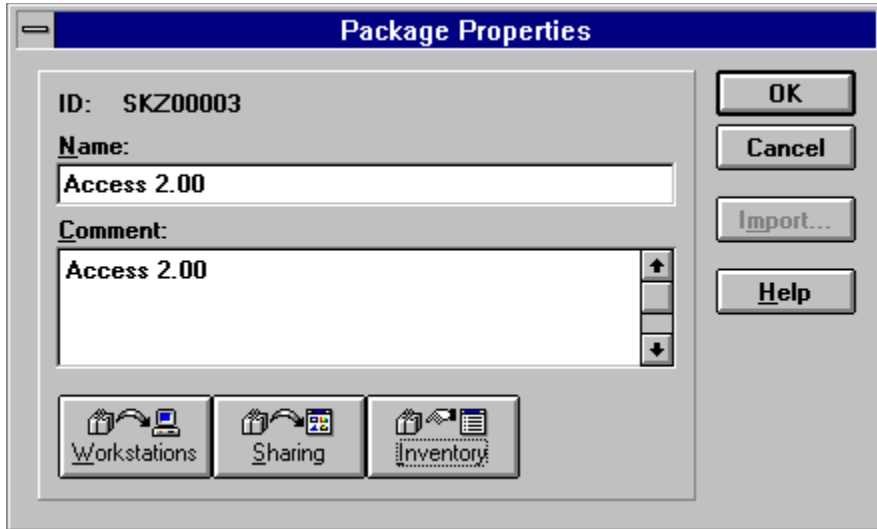

3. In the Name box, type a name for the package.
4. In the Comments box, add text to further describe the package.
5. Click Inventory to define the package properties.

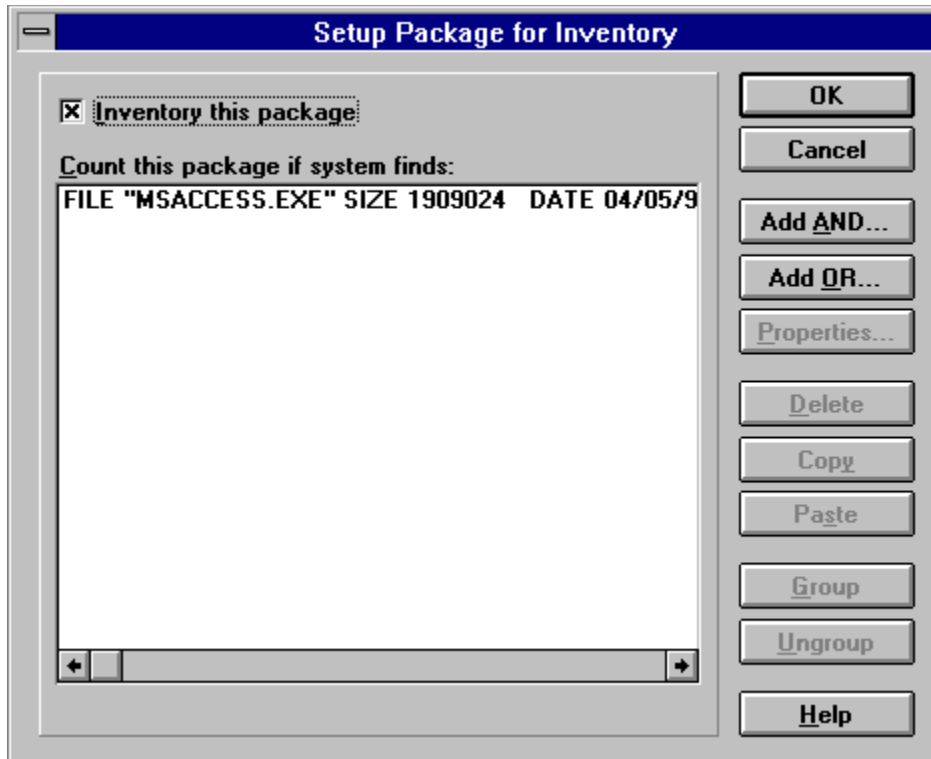

6. Select the Inventory This Package check box.
By selecting this check box, you include the package in the SMS software inventory. This check box must be selected to define the Inventory properties.
7. Define the files used to identify the package (the inventory rule).
For instructions on defining the inventory rule, see the *Systems Management Server Administrator's Guide*.
8. Define other properties by choosing the appropriate properties button.
9. Click OK to return to the Package Properties dialog box. Then click OK to close the Package Properties dialog box.

The package is added to the SMS system database and appears in the Packages window. If Inventory has been set, the package is included in the software inventory. Systems Management Server creates a system job to add the package to all primary sites beneath the site where the package is created.

When you create a package with Inventory properties, that package is added to a package rule file for the site.

Package rule file.

A package rule file is an ASCII text file that contains rules for collecting an inventory of software. Each rule in the file is the name of a program and, optionally, a set of attributes for that file. Here are the rules used to inventory Microsoft Access 2.0 and MS-DOS 6.0.

```
PACKAGE 1 "Access 2.00" FILE "MSACCESS.EXE" SIZE 1909024 DATE 04/05/94
PACKAGE 2 "Microsoft DOS 6.0" FILE "COMMAND.COM" DATE 03/11/93
```

The package rule file is used to generate a configuration file that is distributed to all logon servers at the site. When the Inventory Agent runs from the client, it uses this configuration file to determine which packages (that is, which files) it should look for on the client. Packages listed in the configuration file that are found on the client are reported as inventory and stored in the site database. This information is passed all the way up the hierarchy to the central site.

You can add Inventory properties to an existing package with either Workstation or Sharing properties, or create a package with only Inventory properties defined.

Software Distribution and Installation

Systems Management Server makes it easy to automatically distribute commercial or internally-developed applications, upgrades or fixes, or virus-checking software to selected personal computers on the local network and at remote sites.

The following lists the steps in the software distribution and installation process:

- Query the database to identify the workstations and servers on which you want to install new software or share applications.
- Prepare a package for distribution to client systems.
- Create a job to install or share software.
- Send the package to the site's distribution servers at each site.
- Install the software on, or allow sharing of the application to, the target computer.

Querying the SQL Server Database

Inventory information gathered by Systems Management Server is stored in the SQL Server database, which the administrator can query to identify computers that meet certain qualifications. (For example, you could query a site for all computers that are currently running Windows 3.1 and that meet other requirements, and target them for an upgrade to Windows 95.)

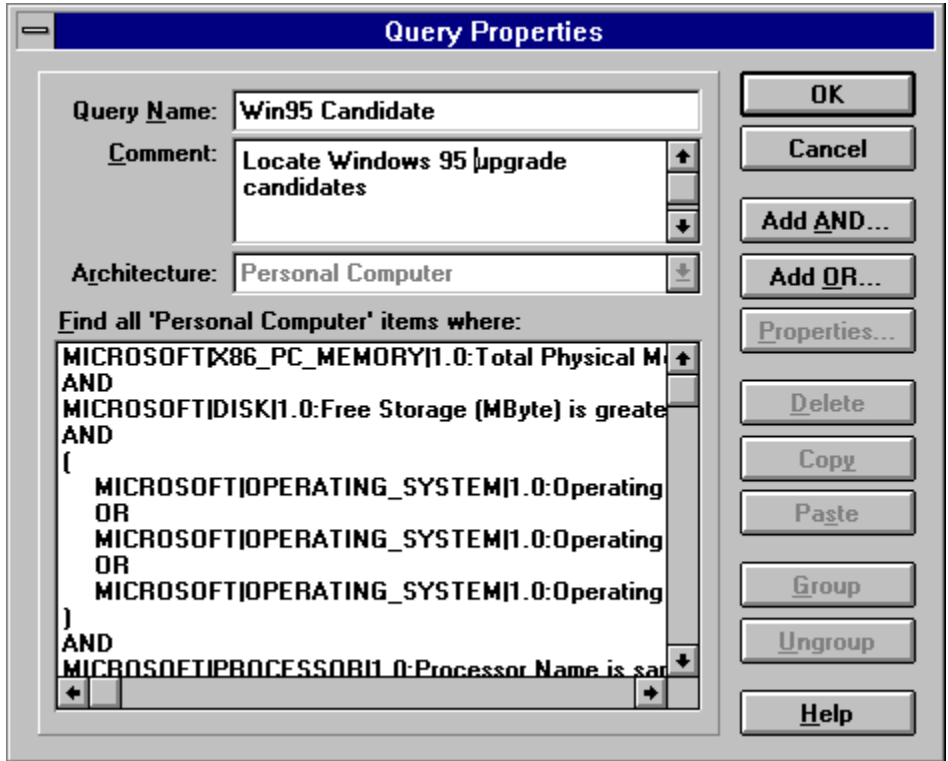

Systems Management Server provides some predefined queries, or you can write your own. When you run a query, all computers that meet the criteria of the query are listed in a window, similar to the one in the following illustration.

Query Results - Computers with Nearly Full Disks...							
Computers with Nearly Full Disks... (Resolved) - Limited to SK (Subsites included)							
4 'Personal Computer' items at 4/18/95 9:17:59 AM							
Name	SMSID	Site	Domain	SMSLocation	SystemRole	SystemType	
STEVEK2	SK100002	SKZ	SKDOMAIN	SKZ SKDOMAIN ST	Workstation	X86-based P	
stevek1	SKZ00001	SKZ	SKDOMAIN	SKZ SKDOMAIN ste	Workstation	X86-based P	
V-SLAMB1	SKZ00002	SKZ	SKDOMAIN	SKZ SKDOMAIN V-	Workstation	X86-based P	

Creating Packages

Systems Management Server uses packages to store information about software so it can be installed on clients, shared from servers, inventoried, or even removed from a computer. Before creating a package to distribute or share software, you must place all the files you want to use for the package in a shared source directory on a server or local drive. You then create a package by identifying the files (those now in the source directory) and defining the package's properties. This is the configuration and identification information used either to install the package on clients (Workstation Properties), or to share the package so that it can be run from network servers (Sharing Properties).

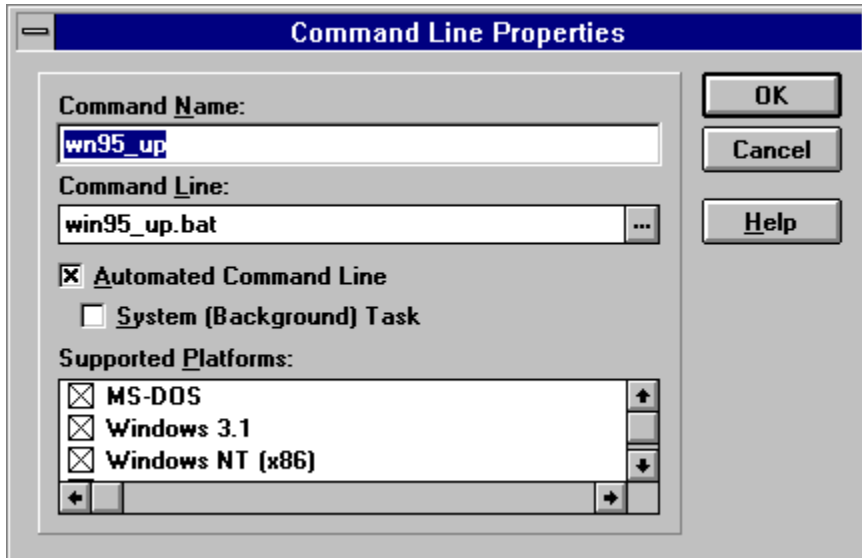

Workstation properties.

Packages with Workstation properties and Run Command On Workstation job type are used to install software, such as Windows 95, on target clients. Rather than having to personally visit each computer attached to your LAN, you can create a job that sends the package to distribution servers. When each target computer logs on to the network, a program called the Package Command Manager (PCM) runs automatically and allows the user to install the new software by choosing the package from the PCM Window.

Package Command Manager (PCM).

This program is installed and set up automatically when the computer is first inventoried by Systems Management Server. At intervals set by the administrator or user, the Package Command Manager checks to see if there are any software installation jobs intended for its computer. If there are, it retrieves the software from the local distribution server and follows the installation instructions. You can give the user the option of accepting the package now or later, and you can set a deadline by which the user must accept the package. Systems Management Server can even install operating system software, such as Windows 95, when the computer is unattended—overnight, for example.

Sharing properties.

Packages with Sharing properties and Share Application On Server job type are used to install, and then share, software on one or more networked file servers. This job sends the package to the distribution servers at a site, shares the necessary network directories, and makes the package available to users with the specified access permissions.

Packages can have one or more properties defined. In other words, a package with both Workstation and Inventory properties defined would allow installation of new software to a target client, and then include the new software in the site's inventory.

You can define packages for commercial applications, for applications you have developed, and for

data files. Systems Management Server includes package definition files (PDFs) that specify the setup programs, installation options, and execution command lines for certain applications. In addition, software developers might create package definition files for their applications. If there is a PDF for the application you want to install, import it to automatically define all the variables. The PDF for Windows 95 is called WIN95.PDF.

Microsoft Systems Management Server
Systems Management Server Services
Software Distribution and Installation
Creating Jobs

After defining the package, you have to let Systems Management Server know where to send it. To do this, drag and drop the defined package onto the site (in the Site Properties Window) and fill in a few job details, including the distribution servers to use and the type of job—Run Command On Workstation, Share Application On Server, and Remove Shared Package From Server—corresponding to the package properties.

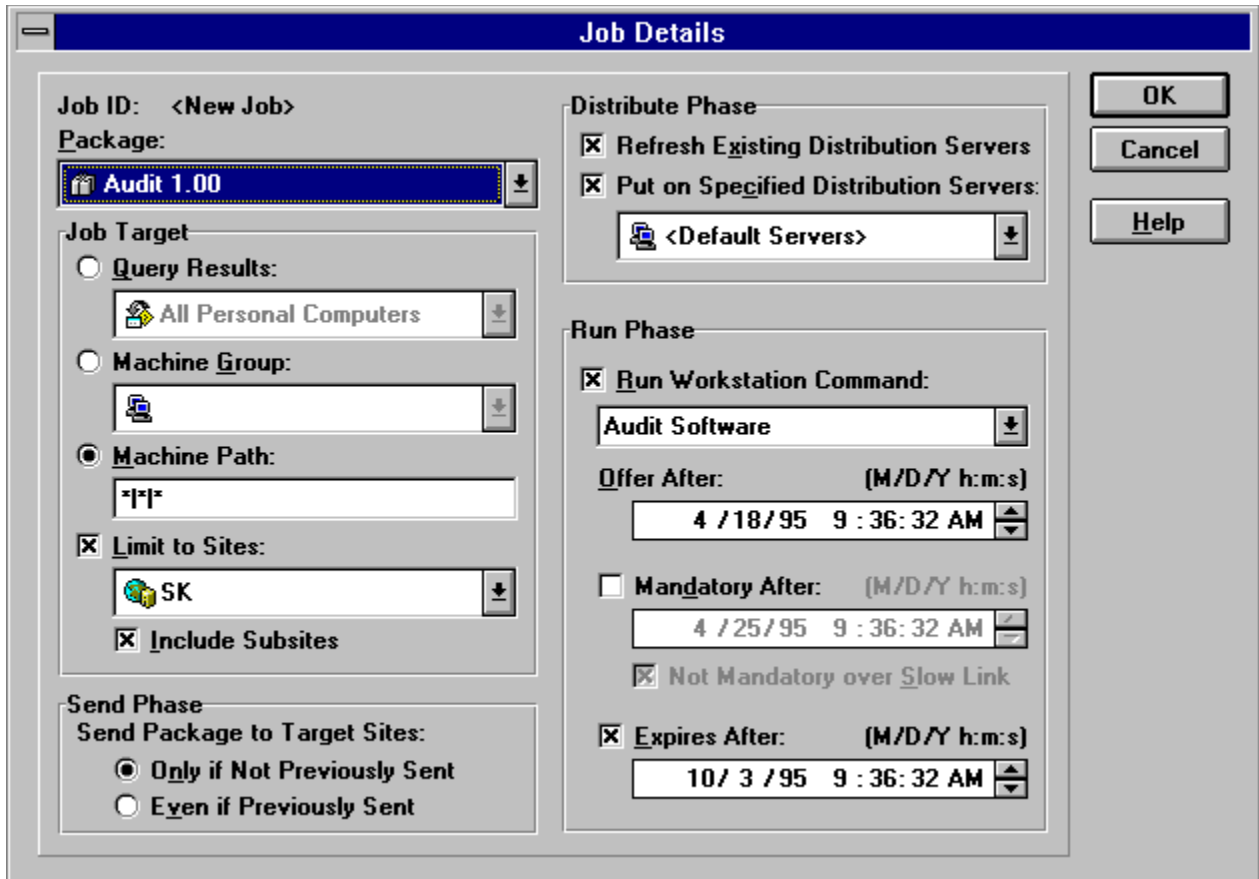

Systems Management Server can distribute packages to each site over any LAN or WAN protocol supported by Windows NT Server (such as TCP/IP or IPX), over an SNA backbone, or over standard serial lines (including ISDN or X.25).

After you have defined the package properties and the job details, Systems Management Server takes over the distribution process, installing or sharing the software from the distribution server, or performing an inventory — typically all without any user input.

Microsoft Systems Management Server
Systems Management Server Services
Software Distribution and Installation

Distributing the Software

Before Systems Management Server distributes a package, it compresses it, thereby reducing the amount of traffic on the network. As the package is passed through the hierarchy, Systems Management Server manages error detection and correction over the WAN. If the distribution requires more time than is available on the link you've specified between sites, Systems Management Server distributes segments of the package sequentially when the WAN is available. When the package arrives at the site, it is placed on the specified distribution servers.

After the package has been copied to the distribution site and uncompressed, Systems Management Server uses the package properties and job type to determine what to do with the it next.

Microsoft Systems Management Server
Systems Management Server Services

Managing Shared Applications

With the Program Group Control feature, Systems Management Server can control access to shared applications to balance loads and provide fault tolerance and metering. When a user logs on to the network from any computer, a program called Program Group Control checks the local server applications database to see if the person who logged on has access to any server applications. If so, Program Group Control program builds and program groups are displayed that contain icons for the appropriate applications. If the user chooses an icon to launch a server application, Program Group Control again checks the local server applications database to see which distribution servers have the application. It connects the user to an available server and starts the application. Because Program Group Control can connect to any available distribution server, you can install the application on several servers to balance the network load and to make sure that users always have access to their network applications, even if one of the servers is down.

Microsoft Systems Management Server

Systems Management Server Services

Remote Control and Troubleshooting

Systems Management Server provides the Help Desk and Diagnostics features that offer the ability to directly control and monitor remote clients running MS-DOS, Windows 3.1, Windows for Workgroups, and Windows 95.

Help Desk

The Help Desk utilities provide direct access to a client, allowing you to troubleshoot and support individual remote computers, with obvious cost savings to the organization.

Using the Windows NT Server and Windows NT Workstation management tools from a Systems Management Server administration console, an administrator or technician can take control of a remote computer running Windows or MS-DOS to perform management or troubleshooting tasks. From one central location, across either a LAN or WAN, the administrator or technician can:

- Monitor the state of the remote computer, including details of dynamic system resource utilization
- View the remote computer's screen and guide the user through a difficult task
- Use Remote Chat for two-way text messaging between the administrator and the client computer
- Perform a task directly, with or without the user being present
- Remotely carry out commands
- Check the memory map, the status of interrupts, and other operating system parameters
- Transfer files and install software
- Restart the remote computer

When the Help Desk option is run, Systems Management Server verifies that the client computer is running and attached to the network. Help Desk attempts connection using various protocols installed on the server until the server successfully connects to the client computer. The Help Desk feature works across X.25, ISDN, and standard asynchronous phone lines, and any normal routed network.

Users can control the degree of remote access they want by setting the following options:

- Remote viewing
- Remote take-over
- Remote file transfer
- Remote boot
- Remote performance of commands

Notice that the use of these help desk utilities requires the knowledge and permission of the remote user. Remote file transfer and remote execution of commands must be enabled for the client to participate in software distribution through Systems Management Server.

Diagnostics

The Diagnostics utilities allow you to view the current hardware and software configuration of a workstation. The following table shows diagnostic utilities for Windows 95 clients.

Item	Description
CMOS Info	Displays the CMOS memory data, which is used during startup to configure the client computer
Device Drivers	Provides information about the device drivers
DOS memory	Lists the programs currently loaded in conventional memory
GDI Heap	Lists and describes the characteristics of memory objects in the local memory storage for the graphical device interface
Global Heap	Lists the addresses of memory objects in the remote client's global memory storage, along with various characteristics associated with each object
Interrupt vectors	Lists the MS-DOS interrupt vector table
Ping Test	Sends packets between the administrative console and the client; verifies the accuracy of transmission
ROM Info	Provides detailed information about all installed read-only memory chips
Window Classes	Provides information about Windows classes used in programs
Windows Memory	Provides information about memory and available memory resources
Windows Module	Provides information about active code modules
Windows Tasks	Provides information about programs listed in the Task List

These tools provide the ideal solution for help desk operators, allowing them to resolve many user problems from a central location.

Network Protocol Analysis

The Network Monitor component of Systems Management Server is a diagnostic tool that allows administrators to look at the details of network packets, perform remote captures on a packet anywhere on the network, and gather network statistics about a group of personal computers. It enables network administrators to capture and analyze network traffic and detect problems or potential network bottlenecks.

Network Monitor provides a graphical display of network statistics that you can use to perform routine troubleshooting tasks, such as locating client-to-server connection problems, or finding a computer making a disproportionate number of work requests.

With Network Monitor, you can do the following:

- Capture frames (also called packets) directly from the local network
- Capture frames from a remote computer
- Display and filter captured frames
- Edit and transmit captured frames onto the network to test network resources or to reproduce network problems
- Display statistics on frames captured locally or on a remote computer

Network Monitor monitors the network data stream, which consists of all of the information transferred over a network at any given time. Prior to transmission, this information is divided by the networking software into smaller segments, called frames or packets. Each frame contains the following information:

- The source address of the computer that sent the message, which is a unique hexadecimal number that identifies the computer on the network
- The destination address of the computer that received the frame
- Headers from each protocol used to send the frame
- The data or a portion of the information being sent

Except in a token-ring or a subnetwork environment, every computer on the network is exposed to all network activity, but the network adapter in each computer typically passes on to the computer only the frames addressed to it. Network Monitor requires that the network adapter be in promiscuous mode, which forces it to examine all frames on the network, rather than just those addressed to it. Network Monitor then filters, counts, and copies all the frames it detects to its capture buffer, which is a reserved storage area in memory. This process is referred to as capturing.

Important To use Network Monitor, you need a network adapter that supports promiscuous mode. Read the documentation that accompanies your adapter to determine if it supports promiscuous mode.

Although the amount of information Network Monitor can capture is limited only by the amount of memory available on your computer, you usually need to capture only a small subset of the frames traveling on the network. To single out a subset of frames, you can design a capture filter, which functions in the same manner as a database query. You can filter on the basis of source and destination addresses, protocols and protocol properties, or by specifying a data pattern.

If you want a running capture to respond to events on your network as soon as they are detected, you can design a capture trigger. A capture trigger performs a specified action, such as starting an executable file, when Network Monitor detects a particular set of conditions on the network.

For more information about using Network Monitor, see the *Systems Management Server Administrator's Guide*.

Using Systems Management Server to Deploy Windows 95

Whether you are upgrading ten or ten thousand clients to Windows 95, Systems Management Server allows you to perform an automatic upgrade with no intervention from you or the user.

For an overall deployment plan, see the general and detailed discussions provided in [Deployment Planning Basics](#), and [Deployment Strategy and Details](#). This section provides specific information about how Systems Management Server tools help you in planning for and automating the Windows 95 rollout to your company.

The first step in the upgrade process is to determine which of your computers are appropriate for upgrading to Windows 95. Using Systems Management Server, query the SQL Server database to locate all computers that match the upgrade specifications. A predefined query included in Systems Management Server examines the CPU, the operating system, the available hard disk space, the installed RAM, and so on. You can use this query as is or modify it to include additional criteria important to your installation.

After identifying the target computers, you are ready to roll out Windows 95 to target computers. The following is an overview of the steps involved in deploying Windows 95 with Systems Management Server:

- Create and share a package source directory for the Windows 95 files. This directory can be on any server that can be shared with the network.
- Copy the appropriate files from the Windows 95 compact disc to the new package source directory. If you are copying from the compact disc, you can use the Server-based Setup (**netsetup**) to copy all files to the source directory. For information, see [Server-Based Setup for Windows 95](#). If you are copying from a server that already contains an installation created using Server-based Setup, you can use **xcopy** to copy the files and the directory structure.
- From the Systems Management Server 1.1 compact disc, copy the following files to the package source directory:
 - WIN95.INF file from SMS\LOGON.SRV\MSTEST
 - DOS2W95.EXE file from SMS\LOGON.SRV\MSTEST (if you are setting up clients that run MS-DOS)
- Review WIN95.INF for your configuration, and make appropriate changes (such as changing the time zone).
- Create a package containing the Windows 95 source directory.
- To install Windows 95 on one or more clients, create a mandatory job to distribute the package to the clients.
- Send the job to the target computer.

Windows 95 Deployment Procedures

The first step in the upgrade process is to determine which of your computers are appropriate for upgrading to Windows 95. The easiest way to do this, if you have Systems Management Server installed, is to query the SQL database to locate all computers that match the upgrade specifications.

Depending on your installation, you may be able to use a single query to identify all upgrade candidates, or you might have to write several queries, and upgrade the installation in stages. You will typically end up with at least one query for each Windows 95 configuration you want to install; after running the query, you can use the results as the target for your installation package.

A typical query for an upgrade of desktop computers might specify:

- A 386DX processor or better
- MS-DOS version 5.0 or later, Windows, or Windows for Workgroups
- 35 MB or more of hard disk space
- 4 MB or more of installed RAM
- Windows 95 is not already installed

The following table lists the amount of hard disk space required, according to the operating system being upgraded.

Existing operating system	Compact	Typical	Full
New (no system installed)	30 MB	40 MB	50 MB
Windows 3.1	15	35	40
Windows for Workgroups 3.11	15	30	35

Systems Management Server includes some predefined queries that are ready to use. You can modify one of these, if appropriate, to query for criteria that are specific to your organization. The following steps show you how to create a simple query. To create a more complex query, repeat several of the steps to add more properties to your query.



To create a simple query that detects computers running Windows for Workgroups

1. From the Systems Management Server Administrator tool, open the Queries window.
2. From the File menu, choose New. The Queries Properties window appears.

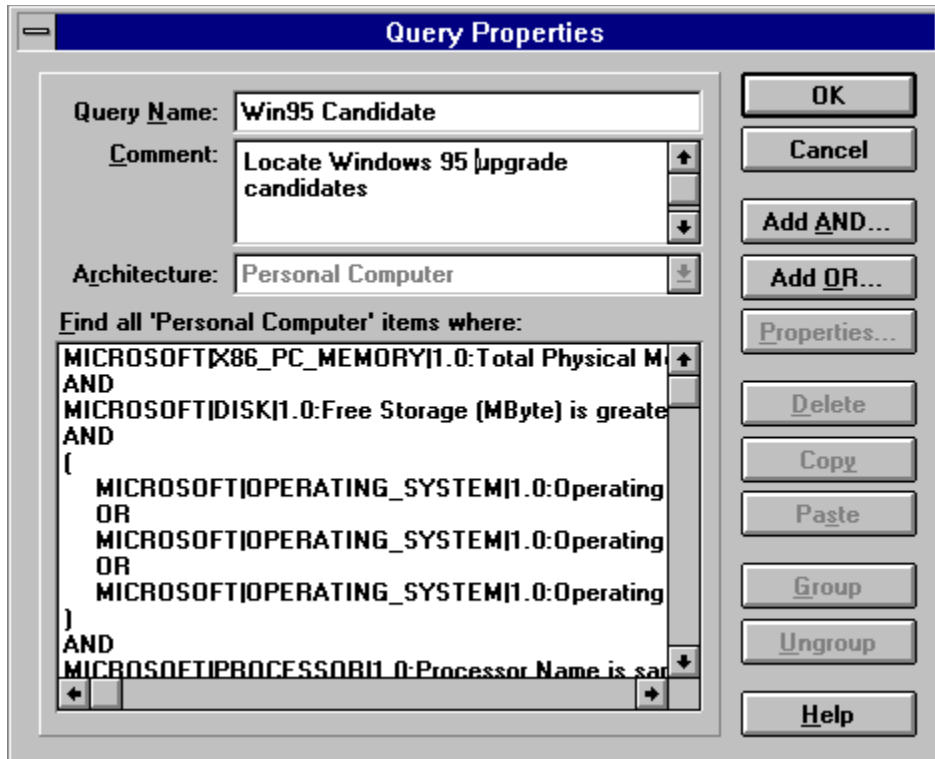

3. In the Query Name box, type **Windows 95 Candidates** and click Add AND. This opens the Query Expression Properties dialog box.

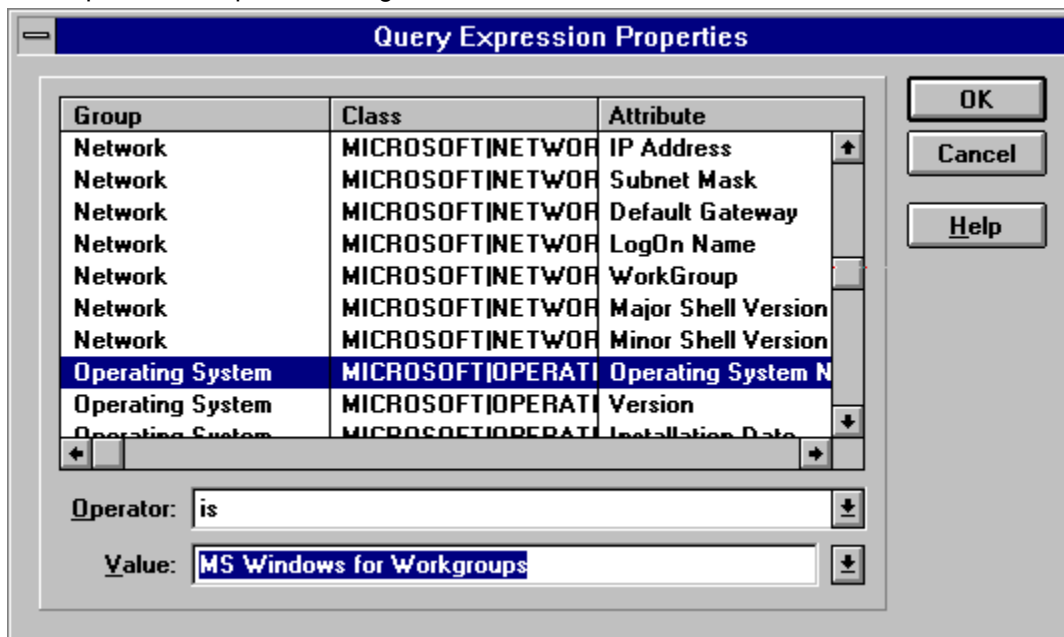

4. Scroll down the list until you find the Operating System group, and then select the Operating System Name attribute.
5. In the Operator box, select is.
6. In the Value box, select MS Windows for Workgroups.
7. Click OK to return to the Query Properties dialog box with your query displayed.

8. Click OK, and then minimize the Queries window.

This creates a simple query that has only one property — that the operating system is Windows for Workgroups. You can use the Add AND or the Add OR functions to define more query details.

There are two ways you can execute a query:

- You can choose Execute Query from the File menu, select the query you want to execute, and click OK. The Query results window appears listing all the computers that meet the criteria of the query, as shown in the following illustration.

Name	SMSID	Site	Domain	SystemRole	SystemType
DINGO	PH700001	PH7	OUTBACK	Server	ALPHA-based PC
POSSUM	PH702000	PH7	OUTBACK	Server	MIPS-based PC
KOOKABURRA	PH701004	PH7	OUTBACK	Server	X86-based PC
ECHIDNA	PH700003	PH7	OUTBACK	Server	X86-based PC
PLATYPUS	PH701001	PH7	OUTBACK	Workstation	X86-based PC
KANGAROO	PH400001	PH4	BIGHT	Server	X86-based PC

- You can also simply drag the query from the Queries window and drop it onto the site (in the Sites window) that you want to run the query on, as shown in the following illustration. This makes it easy for administrators to run queries on certain sites as required.

The screenshot shows the Microsoft SMS Administrator interface. The 'Sites' window displays a tree view on the left with 'Phil's Central Site' expanded to show 'Phil's Secondary Site', 'BIGHT', and 'OUTBACK'. The main pane shows a table of computer details for the selected site.

Name	SMSID	SystemType	SystemRole
DINGO	PH700001	ALPHA-based PC	Server
POSSUM	PH702000	MIPS-based PC	Server
ECHIDNA	PH700003	X86-based PC	Server
KOOKABURRA	PH701004	X86-based PC	Server
PLATYPUS	PH701001	X86-based PC	Workstation

The 'Queries' window below shows a table of existing queries:

Name	ID	Architecture	Comment
All Machines	PH700001	Personal Computer	All Machines
Job Status = 4	PH700003	JobDetails	Job Status Report
Windows NT Computers	PH700004	Personal Computer	Windows NT Computers

The status bar at the bottom indicates 'Ready' and '1 item(s) selected of 3'.

Here are the basic steps in using Systems Management Server to roll out Windows 95.



To roll out Windows 95 using Systems Management Server

1. Create and share a package source directory for the Windows 95 files. This directory can be on any server that can be shared with the network.
2. Copy the appropriate files from the Windows 95 compact disc or floppy disks to the new package source directory. If copying from the compact disc, you must use Server-Based Setup (as described in [Server-Based Setup for Windows 95](#)) to copy files to the source directory. If you are copying from a server that already contains an installation created using Server-based Setup, floppies, you can use **xcopy** to copy the files and directory structure to another server.
3. From the Systems Management Server 1.1 compact disc, copy the following files to the package source directory.
 - WIN95.INF file from SMS\LOGON.SRV\MSTEST.
 - DOS2W95.EXE file from SMS\LOGON.SRV\MSTEST (if you are setting up MS-DOS clients).
4. Review WIN95.INF for your configuration, and make appropriate changes (such as the time zone).
5. Create a package containing the Windows 95 source directory:
 - From the Systems Management Server Administrator, open the Packages window. From the File Menu, choose New. When the Package Properties dialog box appears, click Import.
 - In the File Browser dialog box, select the WIN95.PDF in the SMS\PRIMSITE.SRV\IMPORT.SRC\ENU directory, and then click OK.
 - Click Workstations. In the Source directory box of the Setup Package For Workstations dialog box, type the location of the Windows 95 package source directory (or click Browse [...] to find it). This is the package source directory that you created earlier. Then click Close, and click OK.
6. When ready to install Windows 95 on one or more clients, create a job to distribute the package to the clients.
 - From the Systems Management Server Administrator, open the Packages window. Open the Sites window.
 - In the Packages window, select the package you created for the operating system, and drag it to a client, machine group, or site in the Sites window.
 - Complete the Job Details dialog box, making sure to choose the correct client command appropriate for the operating system environment of the target clients on which the job will be run. Use Automated Setup For Windows/WfW Clients for computers running Windows 3.x, or use Automated Setup For DOS Clients for computers running MS-DOS.
7. Send the job to the target computers.

The Windows 95 installation process requires the User Name, Domain/Workgroup Name, and Computer Name for the targeted client. These values are left blank in the WIN95.INF template. There are several ways for the installation program to acquire this information:

- Determine whether the input Windows 95 script file (usually WIN95.INF) has UserName set.
- If not, check in the client's SMS.INI for the UserName (this is an optional field that people can set using PCM).
- Then, make sure there's an MSBATCH.INF file in the Windows directory and that it has the UserName set (computers running Windows 95 will have this file from their last installation).
- Next, check if there's a SERIALNO.INI file in the Windows directory that has UserName set (computers running Windows for Workgroups will have this file from the installation).
- Finally, have the UserName default to the same value as the computer name. The computer name was either specified in the INF file or copied from the MachineName field in SMS.INI.

Check the README.TXT file for further information.

For Windows-based clients, the user must close all applications before starting the automated Windows 95 installation. If an application is open, the installation will pause until the user closes it. Also, certain warning and error conditions can occur during the installation process that might pause or terminate the installation.

Introduction

This appendix describes how you can integrate Apple® Macintosh® computers and computers running Windows 95 on the same network using the Windows NT Server Services for Macintosh, and offers tips for users who are switching from Apple Macintosh to Windows 95.

- Windows NT Services for Macintosh
- Exchanging Mail Between Windows 95 and Macintosh
- Switching from Macintosh to Windows 95

Windows NT Services for Macintosh

Microsoft Windows NT Server Services for Macintosh is a thoroughly integrated component of Microsoft Windows NT Server, making it possible for computers running Windows 95, MS-DOS, Windows, Windows for Workgroups, Windows NT, and Apple Macintosh to share files and printers. After Services for Macintosh is set up, that computer can function as an AppleTalk® router. Routing capability is supported for AppleTalk Phase 2.

With Services for Macintosh, Macintosh computers need only the Macintosh operating system software to function as workstations; no additional software is required. You can, however, set up the optional user authentication module, which provides a secure logon to the computer running Windows NT Server.

When you set up Services for Macintosh on a computer running Windows NT Server, the AppleTalk Protocol, File Server for Macintosh, and the Print Server for Macintosh are started, or enabled. An explanation for each of these follows:

- The AppleTalk Protocol is the layer of AppleTalk Phase 2 protocols that delivers data to its network destination. The AppleTalk Protocol can be configured through the Network icon in the Windows NT Server Control Panel.
- File Server for Macintosh, also called MacFile, allows you to designate a directory as a Macintosh-accessible volume, ensures that Macintosh filenames are valid Windows NT file system (NTFS) names, and handles permissions. When set up, File Server for Macintosh commands appear in the Windows NT Server File Manager and Server Manager under the MacFile menu.
- Print Server for Macintosh, also called MacPrint, allows all network users to send print jobs to a spooler on the computer running Windows NT Server and continue to work, rather than wait for their print jobs to complete. Windows-based users can also review the print jobs in Print Manager.

Setting up Services for Macintosh creates an icon in Control Panel on the Windows NT Server computer, which gives you the same server administration capabilities as the MacFile menu, excluding volume management. For complete information, see the *Windows NT Server Services for Macintosh* documentation.

Macintosh and Windows 95

Exchanging Mail Between Windows 95 and Macintosh

Upgrading a Windows 95 postoffice to a full Microsoft Mail Server postoffice with the *Microsoft Mail Post Office Upgrade* product allows clients running MS-DOS, Windows, Windows for Workgroups, Windows 95, Windows NT, Macintosh, and OS/2 to exchange mail.

However, before Macintosh clients can use the Microsoft Mail Server, you need a file server capable of sharing files for both Intel-compatible computers and Macintosh computers. Windows 95 File and Print Sharing services do not work with Macintosh computers. Therefore, you need to install the Microsoft Mail Server on a Windows NT or a Novell® NetWare® server.

Switching from Macintosh to Windows 95

The following section offers tips to Apple Macintosh users who are new to Windows 95.

How different is the Windows 95 desktop?

Your drives are not on the desktop but are easily accessible by double-clicking My Computer. Then double-click the drive with contents you want to view.

You can put shortcuts to programs and documents directly on the desktop for easy access. Shortcuts are similar to aliases on the Macintosh. You can remove a shortcut from the desktop by deleting its icons. To create a shortcut, right-click a folder or file, and then choose the Shortcut option.

Deleted files are temporarily moved to the Recycle Bin. You can double-click the Recycle Bin icon to see its contents (and restore any contents). To permanently delete a file or program, open the File menu, and then click Empty Recycle Bin.

Why does the mouse have two buttons?

Use the left button — the main button — for most tasks unless the right button is specified in a Help procedure. If you click an item using the right button, a menu is displayed containing commands specific to the item.

How do I find documents?

Documents are stored in folders. To view the folders on your computer, double-click My Computer, and then double-click a drive. Double-click a folder to see its contents.

How do I start a program?

All programs are on the Start menu. Click the Start button, point to Programs, point to the program folder, and then click the program name.

How can I switch between programs?

A program button is added to the taskbar at the bottom of the desktop each time you open a program. The taskbar works in a manner similar to the Apple Macintosh Application menu, but instead of opening a menu, you click the button on the taskbar to switch between programs. You can drag the taskbar to the top or to either side of the desktop.

How do I save a document?

You can save a document by using the Save command on the File menu. You can save it to any folder on any drive, and change which folder you save it to in the Save dialog box. Here are a few things you need to know when saving documents.

- In Windows 95, the hard disk drive and floppy disk drives are identified by a letter. Most hard disk drives are assigned the letter C. Usually, the floppy disk drives are A and B.
- A path tells you where the document is located. It contains the drive letter and folder names in which the file is stored. For example, a path could be: C:\JUNE\WORK\SCHEDULE. This tells you that the SCHEDULE document is located on the C drive in a folder named WORK that is in the JUNE folder.

How do I open a menu?

Click once to open the menu, and then click your selection. You no longer need to press and hold the mouse button to keep the menu open.

How do filenames differ between systems?

In Windows 95, you can now use long filenames (up to 256 characters). Each file has a three-character filename extension (*filename.ext*) to identify the file type (sometimes it also identifies the program that created the file). Filename extensions are not included when documents are listed on the Start menu or displayed in My Computer.

What are the three icons in the upper right corner?

The three icons in the upper right corner of the desktop window are used as follows:

- Use this icon to reduce the window to a button on the taskbar. Click the taskbar button to open the window again.
- Use this icon to enlarge the window so that it covers the entire desktop

(except for the taskbar).

- Use this icon to close the window.

Where do I find the items from the Macintosh menu?

The following procedures are used to find programs and documents in Windows 95:

- Click the Start menu to see most menu items.
- Customize system settings by pointing to Settings.
- Point to Documents to see a list of the documents you recently opened.
- Use Shut Down to exit Windows 95.

How can I use the Windows online Help to learn more?

To view a list of Help topics or search for a topic using the Help index, open Help from the Start menu.

For help on specific items in a window, click the question mark in the upper right corner of the dialog box, and then click the item to find out about it.

Introduction

This appendix describes how to modify HOSTS and LMHOSTS files to support address-to-name resolution in Windows 95 networking.

- The HOSTS file is used as a local Domain Name System (DNS) equivalent to resolve host names to IP addresses.
- The LMHOSTS file is used for name resolution when a Windows Internetwork Name Service (WINS) server is not available to resolve NetBIOS computer names to IP addresses.

Each of these files is also known as a *host table*. Sample versions of LMHOSTS (called LMHOSTS.SAM) and HOSTS files are added to the Windows directory when you install Windows 95 with TCP/IP support. These files can be edited using any ASCII editor, such as WordPad or Edit.

Important To use LMHOSTS or HOSTS files for name resolution, the Enable DNS option must be selected. To do this, use the DNS Configuration tab in TCP/IP properties in the Network option in Control Panel.

 [Setting Up HOSTS Files](#)

 [Setting Up LMHOSTS Files](#)

Setting Up HOSTS Files

Microsoft TCP/IP can be configured to search the local host table file, HOSTS, for mappings of remote host names to IP addresses. The HOSTS file format is the same as the format for host tables in the Version 4.3 Berkeley Software Distribution (BSD) UNIX */etc/hosts* file. For example, the entry for a computer with an address of 192.102.73.6 and a host name of TREY.RESEARCH.COM looks similar to this:

```
192.102.73.6    trey.research.com
```

Edit the sample HOSTS file that is created when you install TCP/IP to include remote host names and their IP addresses for each computer with which you will communicate. This sample file also explains the syntax of the HOSTS file.

Host names are used in virtually all TCP/IP environments. A host name always corresponds to an IP address that is stored in a HOSTS file or on a DNS server and is assigned by an administrator to identify a TCP/IP host or default gateway. A host name can be used in place of an IP address when using **ping** or other TCP/IP utilities.

Host names are not used in the Windows 95 network user interface, such as Network Neighborhood or NET.EXE. The only time a host name is used to access a Windows-based computer is when **ping** or **ftp** or another TCP/IP utility is used. In this case, the host name and corresponding IP address must be stored in a HOSTS file.

The HOSTS file is a static file used to map host names to IP addresses. This file provides compatibility with the UNIX HOSTS file. The following describes HOSTS file entries:

- A single entry consists of an IP address corresponding to one or more host names.
- Entries are case-sensitive. Therefore, it is a good idea to assign multiple host names with different cases.

For example, to connect to the UNIX host ARCHIVE.RESEARCH.COM at the IP address 144.3.56.200, make two entries in the HOSTS file:

```
144.3.56.200    ARCHIVE.RESEARCH.COM
144.3.56.200    archive.research.com
```

This way, a user can connect to ARCHIVE using a utility, whether or not the CAPS LOCK is enabled.

A HOSTS file must reside on each system. By default, the host name **localhost** is an entry in the HOSTS file with the loopback address 127.0.0.1.

The HOSTS file is parsed whenever a host name is referenced. Names are read in a linear fashion. The most commonly used names should be near the beginning of the file. HOST file entries do not replace or interact with Windows-based NetBIOS computer names in any way.

The following shows the default HOSTS file provided with Windows 95.

```
# Copyright (c) 1994 Microsoft Corp.
#
# This is a sample HOSTS file used by Microsoft TCP/IP for Windows 95
#
# This file contains the mappings of IP addresses to host names. Each
# entry should be kept on an individual line. The IP address should
# be placed in the first column followed by the corresponding host name.
# The IP address and the host name should be separated by at least one
# space.
#
# Additionally, comments (such as these) may be inserted on individual
# lines or following the computer name denoted by a '#' symbol.
#
# For example:
#
#     102.54.94.97    rhino.acme.com          # source server
```

```
#      38.25.63.10    x.acme.com
127.0.0.1    localhost
```

```
# x client host
```

Setting Up LMHOSTS Files

When you use Microsoft TCP/IP on a local network with any combination of computers running Windows 95, Windows NT, LAN Manager, or Windows for Workgroups, server names are automatically matched to their corresponding IP addresses. However, to match server names across remote networks connected by routers (or gateways), you can use the LMHOSTS file if WINS servers are not available on the network. The LMHOSTS file is commonly used to locate remote computers for Microsoft networking file, printer, and remote access services, and for domain services such as logon, browsing, replication, and so on.

The LMHOSTS file used by Windows 95 contains mappings of IP addresses to Microsoft networking computer names (which are NetBIOS names). Microsoft LAN Manager 2.x TCP/IP LMHOSTS files are compatible with Microsoft TCP/IP.

Microsoft TCP/IP loads the LMHOSTS file into memory when the computer is started. The LMHOSTS file is a text file in the Windows directory that lists the IP addresses and computer names of remote Windows networking servers that you want to communicate with. The LMHOSTS file should list all the names and IP addresses of the servers you regularly access.

For example, the LMHOSTS table file entry for a computer with an address of 192.45.36.5 and a NetBIOS computer name of Finance1 looks like this:

```
192.45.36.5    finance1
```

The format for the LMHOSTS file is the same as the format for host tables in 4.2 MSD UNIX systems. The computer name is optionally enclosed in quotation marks (this is necessary for computer names that contain spaces).



To create an LMHOSTS file

1. Use a text editor to create a file named LMHOSTS, or edit the default file named LMHOSTS.SAM in the Windows directory and then save this file as LMHOSTS.
2. In the LMHOSTS file, type the IP address and the host name of each computer that you want to communicate with. Separate the items with at least one space.

Entries in the LMHOSTS file are not case-sensitive.

You will want to use LMHOSTS for smaller networks or to find hosts on remote networks that are not part of the WINS database (because name query requests are not broadcast beyond the local subnetwork). If WINS servers are in place on an internetwork, users do not have to rely on broadcast queries for name resolution, because WINS is the preferred method for name resolution. Therefore, with WINS servers in place, LMHOSTS may not be necessary.

However, the LMHOSTS file is read when WINS or broadcast name resolution fails, and resolved entries are stored in a system cache for later access. When the computer uses the replicator service and does not use WINS, LMHOSTS entries are required on import and export servers for any computers on different subnetworks participating in the replication.

You can use Notepad or any other text editor to edit the sample LMHOSTS.SAM file that is automatically installed in the Windows directory. The following rules apply for entries in LMHOSTS:

- Each entry should be placed on a separate line.
- The IP address should begin in the first column, followed by the corresponding computer name.
- The address and the computer name should be separated by at least one space or tab.
- The # character is usually used to mark the start of a comment. However, it can also designate special keywords, as described in this section.

The keywords listed in the following table can be used in LMHOSTS using Microsoft TCP/IP. Notice, however, that LAN Manager 2.x treats these keywords as comments.

Keyword	Meaning
#PRE	Added after an entry to cause that entry to be preloaded into the name cache. By default, entries are

not preloaded into the name cache but are parsed only after WINS and name query broadcasts fail to resolve a name. #PRE must be appended for entries that also appear in #INCLUDE statements; otherwise, the entry in #INCLUDE is ignored.

#DOM:domain Added after an entry to associate that entry with the domain specified by *domain*. This keyword affects how the Browser and Logon services behave in routed TCP/IP environments. To preload a #DOM entry, you must also add the #PRE keyword to the line.

#INCLUDE filename Forces the system to seek the specified *filename* and parse it as if it were local. Specifying a Universal Naming Convention (UNC) *filename* allows you to use a centralized LMHOSTS file on a server. You must add a mapping for the server before its entry in the #INCLUDE section and also append #PRE to ensure that it is preloaded (otherwise, the #INCLUDE will be ignored).

#BEGIN_ALTERNATE Used to group multiple #INCLUDE statements. Any single successful #INCLUDE statement causes the group to succeed.

#END_ALTERNATE Used to mark the end of an #INCLUDE grouping.

\0xnn Support for nonprinting characters in NetBIOS names. Enclose the NetBIOS name in double quotation marks and use \0xnn hexadecimal notation to specify a hexadecimal value for the character. This allows custom applications that use special names to function properly in routed topologies. However, LAN Manager TCP/IP does not recognize the hexadecimal format, so you surrender backward compatibility if you use this feature.

Notice that the hexadecimal notation applies only to one character in the name. The name should be padded with blanks so the special character is last in the string (character 16).

The following example shows how all of these keywords are used:

```
102.54.94.98    localsrv #PRE
102.54.94.97    trey      #PRE #DOM:networking #net group's PDC
102.54.94.102  "appname  \0x14" #special app server
102.54.94.123  popular  #PRE #source server
#BEGIN_ALTERNATE
#INCLUDE \\localsrv\public\lmhosts #adds LMHOSTS from this server
#INCLUDE \\trey\public\lmhosts    #adds LMHOSTS from this server
#END_ALTERNATE
```

In the preceding example:

- The servers named **localsrv** and **trey** are preloaded so they can be used later in an #INCLUDE statement in a centrally maintained LMHOSTS file.
- The server named **"appname \0x14"** contains a special character after the 15 characters in its name (including blanks), so its name is enclosed in double quotation marks.
- The server named **popular** is preloaded, based on the #PRE keyword.

Guidelines for LMHOSTS

When you use a host table file, be sure to keep it up to date and organized. Follow these guidelines:

- Update the LMHOSTS file whenever a computer is changed or removed from the network.
- Use #PRE statements to preload popular entries into the local computer's name cache and to preload servers that are included with #INCLUDE statements.
- Because LMHOSTS files are searched one line at a time from the beginning, you can increase the speed of searches for the entries used most often by placing frequently used servers near the top of the file. Follow these with less frequently used servers, and then remote #INCLUDE statements. The #PRE entries should be at the end of the file, because these are preloaded into the cache at system startup time and are not accessed later. Comment lines add to the parsing time, because each line is processed individually.

Introduction

This appendix summarizes the shortcuts that are built into Windows 95 for using the keyboard and mouse to quickly accomplish common actions.

- [Shortcuts for Objects, Folders, and Windows Explorer](#)
- [General Keyboard-Only Commands](#)
- [Accessibility Shortcuts](#)
- [Microsoft Natural Keyboard Keys](#)

Shortcuts for Objects, Folders, and Windows Explorer

The following brief procedures and tables summarize the standard shortcuts for working with objects in the Windows 95 user interface, including folders on the desktop and Windows Explorer.



To copy a file

- Press CTRL while you drag the file to a folder.



To create a shortcut

- Press CTRL+SHIFT while you drag the file to the desktop or a folder.



To close the current folder and all its parent folders

- Press SHIFT and click the Close button on the folder.



To tab through pages in a properties dialog box

- Press CTRL+TAB or CTRL+SHIFT+TAB.



To switch between opening a new window and closing an existing window

- Press CTRL and double-click a folder.

If you have more than one window open, this operation closes the active window. If you have only one window open, this operation opens a new window.



To bypass Auto-Run when inserting a compact disc

- Press SHIFT while inserting the compact disc.

Shortcuts for a Selected Object

Shortcut	Action
F2	Rename
F3	Find
CTRL+X	Cut
CTRL+C	Copy
CTRL+V	Paste
DEL key	Delete
SHIFT+DEL	Delete file immediately without putting it in Recycle Bin
ALT+ENTER	Display properties
ALT+double-click	Display properties
CTRL+click the right mouse button	Place alternative commands on the context menu (Open With)
SHIFT+double-click	Explore an object; if the object does not have an Explore command, this starts the default action (usually the Open command)

Shortcuts for Managing Folders and Windows Explorer

Shortcut	Action
F4	In Windows Explorer, display the combo box and move the input focus to the list
F5	Refresh display
F6	In Windows Explorer, move the focus between panes
CTRL+G	In Windows Explorer, choose the Go To command

CTRL+Z	Undo
CTRL+A	Select All
BACKSPACE	Go to the parent folder

Shortcuts in the Windows Explorer Tree

Shortcut	Action
* on numeric keypad	Expand everything under the selection
+ on numeric keypad	Expand the selection
- on numeric keypad	Collapse the selection
RIGHT ARROW	Expand the current selection if it is not expanded; otherwise, go to the first child
LEFT ARROW	Collapse current selection if it is expanded; otherwise, go to the parent
CTRL+arrow key	Scroll without moving the selection

Shortcuts in the Common Open and Save dialog boxes

Shortcut	Action
F4	Display the Look In list
F5	Refresh the view
BACKSPACE	Go to the parent folder if the focus is on the View window

General Keyboard-Only Commands

The following table shows commands for completing actions from the keyboard.

General Keyboard-Only Commands

Shortcut	Action
F1	Start Help
F10	Go to menu mode
SHIFT+F10	Display context menu for selected item
CTRL+ESC	Display Start menu and move the focus to the taskbar
CTRL+ESC, ESC	Move the focus on the taskbar so you can use TAB and then SHIFT+F10 for context menu, or use TAB and arrow key to change tasks, or use TAB to go to the desktop
ALT+TAB	Switch to the next running application
ALT+M	When the focus is on the taskbar or desktop, minimize all windows and move the focus to the desktop
ALT+S	When no windows are open and no items are selected on the desktop, display the Start menu; then use arrow keys to select menu commands

Accessibility Shortcuts

The following table summarizes the Windows 95 shortcuts for Accessibility features. For information about these features, see [Accessibility](#).

Accessibility Shortcuts

Shortcut	Action
Press SHIFT 5 times	Toggle StickyKeys on and off
Press RIGHT SHIFT for 8 seconds	Toggle FilterKeys on and off
Press NUMLOCK for 5 seconds	Toggle ToggleKeys on and off
Press LEFT ALT+LEFT SHIFT+NUMLOCK	Toggle MouseKeys on and off
Press LEFT ALT+LEFT SHIFT+ PRINTSCREEN	Toggle HighContrast on and off

Shortcuts for Windows 95

Microsoft Natural Keyboard Keys

The following table summarizes the shortcut keys available on the Microsoft Natural Keyboard™.

Microsoft Natural Keyboard Keys

Shortcut	Action
WIN+R	Display Run dialog box
WIN+M	Minimize All
SHIFT+WIN+M	Undo Minimize All
WIN+F1	Start Help
WIN+E	Start Windows Explorer
WIN+F	Find files or folders
CTRL+WIN+F	Find computer
WIN+TAB	Cycle through taskbar buttons
WIN+BREAK	Hot key to display System properties dialog box

Introduction

This appendix describes the new features in Windows 95 that support enhanced accessibility. This appendix also provides information about other Microsoft products and services that make Windows 95 more accessible for people with disabilities.

For information about creating custom setup support to accommodate accessibility needs, see [Custom, Automated, and Push Installations](#).

- [Accessibility in Windows 95: Overview](#)
- [Windows 95 Accessibility Features](#)
 - [General Accessibility Enhancement Features](#)
 - [Features for Users with Low Vision](#)
 - [Features for Making Keyboard and Mouse Input Easier](#)
 - [Features for Users Who Are Deaf or Hard-of-Hearing](#)
 - [Features Supporting Alternative Input Devices](#)
 - [Features for Software Developers](#)
 - [Using Accessibility Features in Windows 95](#)
- [Microsoft Services for People Who Are Deaf or Hard-of-Hearing](#)
- [Keyboard Layouts for Single-Handed Users](#)
- [Microsoft Documentation on Audio Cassettes and Floppy Disks](#)
- [Accessibility-Enhancing Utilities from Other Vendors](#)
- [Getting More Information on Accessibility](#)

Accessibility in Windows 95: Overview

Microsoft is committed to making computers easier to use for everyone, including individuals with disabilities. In recent years Microsoft has established close relationships with users who have disabilities, organizations representing disabled individuals, workers in the rehabilitation field, and software developers who create products for this market. Based on their combined input, Microsoft has defined specific design goals for Windows 95:

- Integrate and improve the features from the accessibility product Access Pack for Microsoft Windows that compensate for difficulties some individuals have using the keyboard or the mouse
- Make the visual user interface easier to customize for people with limited vision
- Provide additional visual feedback for users who are deaf or hard-of-hearing
- Provide new API and "hooks" for ISVs developing accessibility aids, including those that allow blind individuals to use Windows
- Make information on accessibility solutions more widely available and increase public awareness of these issues

Windows 95 offers several enhancements designed to meet these accessibility goals. The primary improvements in accessibility for Windows 95 are:

- Scalable user interface elements
- Features that compensate for difficulties in using the keyboard
- Keyboard emulation of the mouse
- Support for alternative input devices that emulate the keyboard and mouse
- Visual cues to tell the user when the application is making sounds
- Notification to other applications when the user has limited vision, needs additional keyboard support due to difficulty using a mouse, or wants visual captions to be displayed for speech or other sounds
- Notification to other applications when they should modify behavior to be compatible with accessibility software utilities running in the system
- Optimized keyboard layouts for users who type with a single hand, a single finger, or a mouthstick
- Audible prompts during Setup for users who have low vision
- Color schemes that are optimized for users with low vision
- Documentation that includes accessibility information

Windows 95 Setup installs Accessibility Options automatically. To use a computer that does not have Accessibility Options installed, perform the following procedure.



To install accessibility features under Windows 95

1. In the Add/Remove Programs option in Control Panel, click the Windows Setup tab.
2. In the list of components, click Accessibility Options and then click OK.

Accessibility

Windows 95 Accessibility Features

Windows 95 accessibility features fall into the following categories:

- General accessibility features
- Features for users with limited vision
- Features for users who have difficulty using a keyboard or mouse
- Features for users who are deaf or hard-of-hearing
- Features supporting the use of alternate input devices
- Features supporting the development of accessible software

Accessibility

Windows 95 Accessibility Features

General Accessibility Enhancement Features

This section describes general enhancements to the operating system that support accessibility. These include:

- Online Help
- Control Panel support for accessibility features
- Emergency hot keys
- Accessibility time-out
- Accessibility status indicator

Accessibility

Windows 95 Accessibility Features

General Accessibility Enhancement Features

Online Help

An Accessibility section in the Windows 95 Help contents and index provides a quick reference and pointer to topics that can help adjust the behavior of the system for people with disabilities.

Accessibility

Windows 95 Accessibility Features

General Accessibility Enhancement Features

Control Panel Support for Accessibility Features

The Accessibility Options icon in Control Panel controls most of the accessibility features in Windows 95. With Accessibility properties, users can turn the accessibility features on or off, customizing keyboard, sound, display, and mouse operation for their own particular needs.

Accessibility properties dialog box in Control Panel

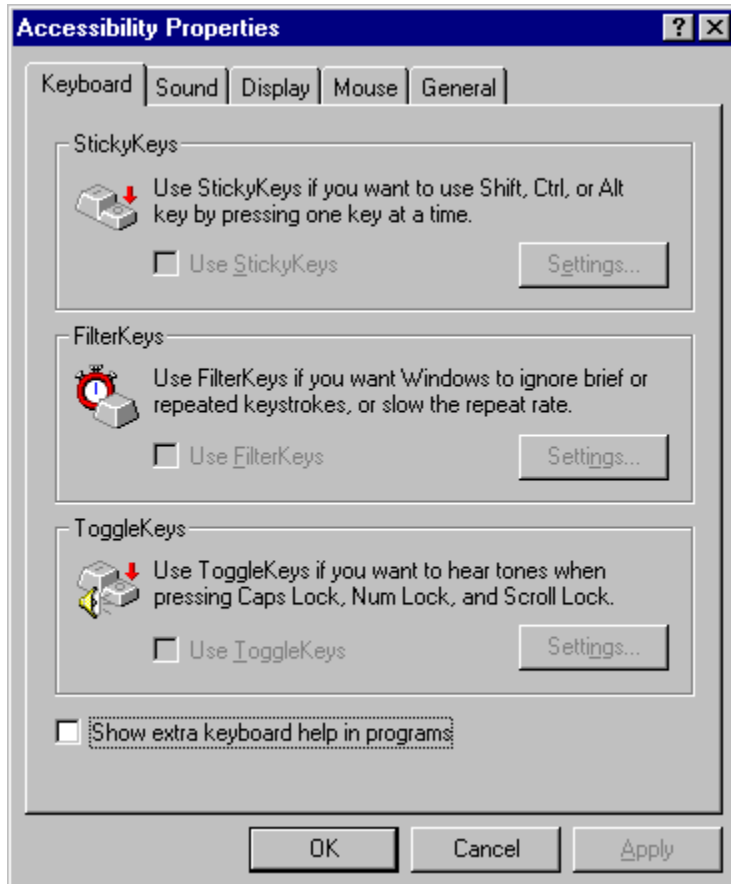

Accessibility

Windows 95 Accessibility Features

General Accessibility Enhancement Features

Emergency Hot Keys

The emergency hot keys provide an alternate method of activating accessibility features, for persons who could not use the computer without first having accessibility features in effect. Also known as shortcuts, the emergency hot keys allow the user to temporarily turn on the specific needed feature. Then, after a feature has been turned on, the user can navigate to Control Panel and adjust the feature to the user's own preferences, or turn the feature on permanently. The same hot key temporarily turns off the feature, if it gets in the way, or if another person wants to use the computer without this feature.

Hot keys are designed to be unique key combinations that should not conflict with keys used by applications. If such a conflict does arise, the hot keys can be disabled, and the user can still use the feature or not, as needed.

As a precaution against accidental use, pressing an emergency hot key causes special tones to sound (a rising siren tone for on, and a falling siren tone for off), and causes a confirmation dialog box to appear, briefly explaining the feature and how it was activated. If the user pressed the hot key unintentionally, the user can cancel the feature's activation at this time. The confirming dialog box also provides a quick path to more detailed help and to the Control Panel settings for the hot-key feature, in case the user wants to disable the hot key permanently.

The following table shows how the hot keys work.

To turn on	Press the following keys
StickyKeys	SHIFT five times
MouseKeys	Left ALT + left SHIFT + NUM LOCK
FilterKeys, with default settings active	Right SHIFT and hold it down for eight seconds
FilterKeys with SlowKeys and RepeatKeys set to the most conservative values	Right SHIFT and hold it down for 12 seconds
FilterKeys with BounceKeys and RepeatKeys set to the most conservative values	Right SHIFT and hold it down for 16 seconds
ToggleKeys	NUM LOCK and hold it down for five seconds
High-contrast Key	Left ALT, left SHIFT, and PRINT SCREEN keys simultaneously

Accessibility

Windows 95 Accessibility Features

General Accessibility Enhancement Features

Accessibility Time-out

The time-out feature of the Accessibilities properties dialog box turns off accessibility functionality after the computer has been idle for a certain period of time. It returns the operating system to its default configuration. This feature is useful on computers shared by multiple users.

Accessibility

Windows 95 Accessibility Features

General Accessibility Enhancement Features

Accessibility Status Indicator

While an accessibility feature is in use, Windows 95 can display an optional visual indicator that tells the user which accessibility features are turned on. This helps users unfamiliar with the accessibility features to identify which ones are in effect. The indicator also provides feedback on the keys and mouse buttons currently being "held down" by the StickyKeys and MouseKeys features. The status indicator can appear on the system taskbar, or as a free-floating window; users can choose the displayed size from a range of different sizes.

Accessibility Status Indicator Window



In the preceding illustration, the three rectangles represent the left SHIFT, CTRL, and ALT keys. As each modifier key is held down by the StickyKeys feature, the corresponding rectangle appears filled.

The mouse in the Accessibility status indicator window may show either the left or the right button shaded, depending on which is selected. Pressing 5, +, or INS is equivalent to using that button. If you have selected working with both buttons (equivalent to using the middle button on a three-button mouse), both buttons are shaded. If you lock down one or more mouse buttons using the INS key, the status indicator shows those buttons as being filled, rather than shaded. (To release them, press DEL.)

The stop watch indicates that the keyboard response is being affected by SlowKeys, BounceKeys, or RepeatKeys features.

Accessibility

Windows 95 Accessibility Features

Features for Users with Low Vision

This section describes the specific accessibility features that Windows 95 provides to users with limited vision, including:

- Scalable user interface elements
- Customizable display for mouse pointer
- High-contrast mode

Accessibility

Windows 95 Accessibility Features

Features for Users with Low Vision

Scalable User Interface Elements

Users who have limited vision or who suffer eyestrain during normal use of a video display can now adjust the sizes of window titles, scroll bars, borders, menu text, and other standard screen elements. These sizes are completely customizable using Appearance properties in the Display option of Control Panel. Users can also choose between two sizes for the built-in system font.

Accessibility

Windows 95 Accessibility Features

Features for Users with Low Vision

Customizable Display for Mouse Pointer

Users who have difficulty seeing or following the mouse pointer can now set the following characteristics, to improve visibility of the mouse pointer:

- Pointer size
- Pointer color
- Speed of the pointer
- Visible trails of pointer movement
- Animation of the pointer

Customizable mouse pointer display schemes are loaded automatically when you install Windows 95 from the compact disc, using Typical setup. If another setup type is used, install the schemes after Setup is run, using the Add/Remove Programs icon in Control Panel. After installation, the user can select, through the Mouse option in Control Panel, a small, medium, or large mouse pointer scheme on a monochrome display.

In addition, with the Windows 95 compact disc, the user can install color schemes and select from red, gray, yellow, green, or violet 16-color schemes for the mouse pointer. Settings for pointer speed and for showing pointer trails (of user-specified lengths) are also available.

Note Not all displays support mouse pointer color schemes.

Windows 95 features an animated hourglass pointer for better viewing.

Accessibility

Windows 95 Accessibility Features

Features for Users with Low Vision

High-Contrast Color Schemes

Windows 95 color schemes allow users to choose from several well designed sets of screen-color options, designed both to match users' individual tastes and to meet their visual needs. The new color schemes in Windows 95 include high-contrast colors, such as white text on a black background, or black text on a white background. These high-contrast color schemes optimize the visibility of screen objects, making it easier for users with visual impairments.

Accessibility

Windows 95 Accessibility Features

Features for Users with Low Vision

High-Contrast Mode

Many users with low vision require a high degree of contrast between foreground and background objects, in order to distinguish the objects. For example, some users may not be able to easily read black text on a gray background, or text drawn over a picture. By setting a global flag, users can now instruct Windows 95 and applications to display information with a high degree of contrast. Activating high-contrast mode automatically selects the user's preferred color scheme.

Users can activate high-contrast mode using Accessibility Options in Control Panel, or using an emergency hot key sequence (pressing left ALT, left SHIFT, and PRINT SCREEN keys simultaneously).

Accessibility

Windows 95 Accessibility Features

Features for Making Keyboard and Mouse Input Easier

This section describes accessibility features that assist users who may have difficulty using the keyboard or the mouse.

Notice that even without installing accessibility features you can use the TAB key in dialog boxes to move the focus (that is, the outline that indicates where you are currently working in the dialog box), and use the arrow keys to select items in a list. In property sheets that have multiple tabs, you can press CTRL+TAB to select each property sheet in order from left to right. Or press the TAB key until the focus is in the tab for the current property sheet, and then press an arrow key to select the next sheet.

Accessibility

Windows 95 Accessibility Features

Features for Making Keyboard and Mouse Input Easier

StickyKeys

Many software programs require the user to press two or three keys at one time. For people who type with a single finger or a mouthstick, that isn't possible. StickyKeys allows users to press one key at a time and instructs Windows to respond as if they had been pressed simultaneously.

When StickyKeys is on, pressing any modifier key (that is, CTRL, ALT, or SHIFT) latches that key down until the user releases the mouse button or presses a key that is not a modifier key. Pressing a modifier key twice in a row locks the key down until it is tapped a third time.

Users can adjust StickyKeys functionality in Control Panel, or turn the feature on or off using an emergency hot key (pressing the SHIFT key five consecutive times).

Accessibility

Windows 95 Accessibility Features

Features for Making Keyboard and Mouse Input Easier

FilterKeys

The sensitivity of the keyboard can be a significant problem for some individuals, for example, if they often press keys accidentally because of a tremor, or because they cannot remove their fingers from keys quickly. Windows 95 includes a series of features designed to work either individually or in combination to compensate for problems in keyboard usage. These features are called SlowKeys, RepeatKeys, and BounceKeys.

SlowKeys instructs Windows 95 to disregard keystrokes that are not held down for a minimum period of time. This allows a user to brush against keys without any effect, and when the user gets a finger on the proper key, the user can hold the key down until the character appears on the screen.

RepeatKeys lets users adjust the repeat rate or disable the key-repeat function on their keyboards. Most keyboards allow users to repeat a key just by holding it down. Although this feature can be convenient for some users, it poses a problem for individuals who can't lift their fingers off the keyboard quickly.

BounceKeys is useful for persons with tremors whose fingers tend to bounce on the keys when pressed or released. When BounceKeys is turned on, this feature instructs your computer to ignore unintended keystrokes.

Users can adjust FilterKeys functionality using the Accessibility Options icon in Control Panel, or turn on or off the specific FilterKeys feature using an emergency hot key. Holding down the right SHIFT key for eight seconds causes a single sound to play and activates this group of features with the user's default settings. If those settings are not appropriate, holding down the key for 12 seconds causes two quick beeps to sound, and turns on the BounceKeys and RepeatKeys features, with their most conservative settings. Holding down the key for 16 seconds causes three quick beeps to sound, and turns on the SlowKeys and RepeatKeys features with their most conservative settings.

Accessibility

Windows 95 Accessibility Features

Features for Making Keyboard and Mouse Input Easier

MouseKeys

This feature lets individuals control the mouse pointer using the keyboard. Although Windows 95 is designed to allow the user to perform all actions without a mouse, some applications may still require one, and a mouse may be more convenient for some tasks. MouseKeys is also useful for graphic artists and others who need to position the pointer with great accuracy. Users do not need to have a mouse to use this feature.

When MouseKeys is on, use the following keys to navigate the pointer on the screen:

- Press one of the numbered keys (also called the arrow keys) on the numeric keypad — except 5 — to move the pointer in the direction indicated in the following figure.

Keys on the numeric keypad that control the mouse pointer

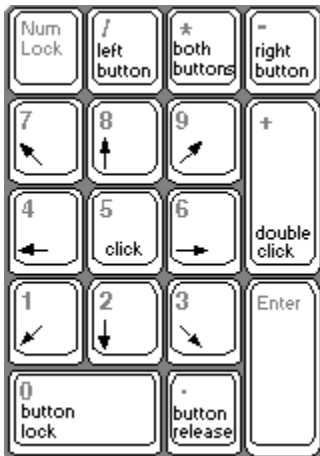

- Use the 5 key for a single mouse-button click and the PLUS SIGN (+) key for a double-click.
- To drag and release an object, place the pointer on the object and press INS to begin dragging. Move the object to its new location and press DEL to release it.
- Select the left, right, or both mouse buttons for clicking by pressing the forward slash (/) key, the minus sign (-) key, or the asterisk (*) key, respectively.
- Hold down the CTRL key while using the arrow keys (numeric keys, except for 5) to cause the pointer to “jump” across large sections of the screen.
- Hold down the SHIFT key while using the arrow keys to move the mouse a single pixel at a time for greater accuracy.

Users can adjust MouseKeys in Control Panel, or turn the feature on or off using an emergency hot key (pressing the left ALT, left SHIFT, and NUM LOCK keys simultaneously).

Note If the MouseKeys feature is on but NUM LOCK is off, the MouseKeys icon in the taskbar shows that MouseKeys is disabled.

Accessibility

Windows 95 Accessibility Features

Features for Making Keyboard and Mouse Input Easier

ToggleKeys

provides audio cues — high and low beeps — to tell the user whether a toggle key is active or inactive. It applies to the CAPS LOCK, NUM LOCK, and SCROLL LOCK keys.

Users can adjust ToggleKeys in Control Panel, or turn the feature on or off using an emergency hot key (holding down the NUM LOCK key for eight seconds).

Accessibility

Windows 95 Accessibility Features

Features for Users Who Are Deaf or Hard-of-Hearing

ShowSounds and SoundSentry provide visible feedback in place of audible signals or speech, to users who have hearing disabilities or who work in extremely noisy conditions.

Accessibility

Windows 95 Accessibility Features

Features for Users Who Are Deaf or Hard-of-Hearing

ShowSounds

This is a global flag that instructs applications to provide visible feedback—in effect asking the applications to be “closed-captioned.”

Accessibility

Windows 95 Accessibility Features

Features for Users Who Are Deaf or Hard-of-Hearing

SoundSentry

SoundSentry tells Windows to send a visual cue, such as a blinking title bar or a screen flash whenever there is a system beep. This allows users to see the message that may not have been heard.

Accessibility

Windows 95 Accessibility Features

Features for Users Who Are Deaf or Hard-of-Hearing

WinChat

You can use the WinChat utility to have an electronic conversation with up to seven other people who are using Windows 95. Unlike an electronic mail message that you compose, save, and then send to another person, a WinChat message is visible to others as you type it. The WinChat utility is provided in the OTHER\CHAT directory on the Windows 95 compact disc.

This utility is appropriate to install on all computers running Windows 95 in an environment that includes users who are deaf or hard-of-hearing. WinChat is the best alternative form of communication when an interpreter or a text telephone (called a "TT" or "TDD") is not available.

If Windows 95 users previously ran WinChat under Windows for Workgroups, and upgraded to Windows 95 in their previous Windows directory, WinChat is still available on their computers.

If Windows 95 is installed on a computer that did not previously have Windows for Workgroups installed, you can install WinChat from the Windows 95 compact disc.



To install WinChat on a computer running Windows 95

1. In the Add/Remove Programs option in Control Panel, click the Windows Setup tab.
2. Click the Have Disk button. In the Install From Disk dialog box, supply the path to the OTHER\CHAT directory on the Windows 95 compact disc.
3. In the Have Disk box, click the WinChat entry in the Components list, and click the Install button.



To make a call or add a person to a call

1. On the toolbar in WinChat, click the Dial button. Or choose Dial in the Conversation menu.
2. In the Select Computer dialog box, type the computer name of the person you want to chat with, and then choose the OK button.

The message in the status bar informs you if the person answers.

You can type your message in the WinChat window before calling someone. The top window displays what you type. The bottom window displays what the other person is typing. Each time you add a person to your conversation, a new window opens. If there are six people in a conversation, there are six windows open.

Only the person who initiates the call can add another person to the conversation or end the conversation.

When a person is added, that person can view the typed conversation that has already taken place. The names of the people in the conversation appear in the title bar and the status bar.

To move between the windows, click the window you're moving to, or press F6. When you finish your conversation, hang up.

When someone calls you, you answer the call to begin your conversation. If WinChat is running, a sound is emitted, and a message appears in the status bar. If WinChat is not running, it starts as an icon on your desktop.



To answer a call

- If the WinChat window is open, click the Answer button on the toolbar. Or choose Answer from the Conversation menu.

If WinChat is running as an icon, double-click the icon, or select it and then press ENTER.

After you answer the call, you can start typing your message.

When you finish your conversation, hang up to disconnect from other participants' computers.



To hang up

- On the toolbar, click the Hang Up button. Or choose Hang Up in the Conversation menu. Or quit WinChat; it will hang up for you.

You can choose to have your computer ignore incoming calls unless WinChat is running.



To prevent incoming calls

1. From the Options menu, choose Preferences.
2. Clear the Autostart Chat When Called check box, and then click OK.

Use the commands on the Options menu to control preferences for window styles, background color, and fonts, and to control the display of the tool bar and status bar. You can also use the Options menu to control whether WinChat rings when there is a call.



To turn the sound on or off

- From the Options menu in WinChat, choose Sound.

A check mark next to the Sound command indicates that sound is on.

If you have a sound card, you can change the sound of the incoming or outgoing ring by using the Sound option in Control Panel.

Accessibility

Windows 95 Accessibility Features

Features Supporting Alternative Input Devices

This section describes Windows 95 support for the use of alternative input devices.

Accessibility

Windows 95 Accessibility Features

Features Supporting Alternative Input Devices

SerialKeys

This feature, in conjunction with a communications aid interface device, allows the user to control the computer using an alternative input device. Such a device needs only to send coded command strings through the computer's serial port to specify keystrokes and mouse events, which are then treated as if they were normal keyboard or mouse input.

Accessibility

Windows 95 Accessibility Features

Features Supporting Alternative Input Devices

Support for Multiple Pointing Devices

The new Plug and Play architecture in Windows 95 inherently supports multiple pointing devices working in combination. This allows seamless addition of alternative pointing devices, such as head-pointers or eye-gaze systems without the need to replace or disable the normal mouse.

Accessibility

Windows 95 Accessibility Features

Features for Software Developers

This section describes how the design of Windows 95 makes it easier for software developers to make their products accessible to individuals with disabilities.

Accessibility

Windows 95 Accessibility Features

Features for Software Developers

Accessibility Guidelines for Software Developers

Windows 95 contains many built-in accessibility features. To make a computer running Windows 95 truly accessible, application developers must provide access to their applications' features, taking care to avoid incompatibilities with accessibility aids.

As part of the *Win32 Software Development Kit for Windows 95 and Windows NT* and *The Windows Interface Guidelines for Software Design*, Microsoft has provided developers with documentation which not only outlines these important concepts, but provides technical and design tips to help ISVs produce more accessible applications. Most of these tips will mean very little additional work to the designer, as long as the application designer is aware of the issues and incorporates accessibility into the application design at an early stage. By providing this information to application developers, Microsoft hopes to increase the general level of accessibility of all software running on the Windows platform.

Accessibility

Windows 95 Accessibility Features

Features for Software Developers

Methods for Simulating Input

Windows 95 now allows developers of voice-input systems and other alternative input systems to easily simulate keyboard and mouse input using fully documented and supported procedures.

Accessibility

Windows 95 Accessibility Features

Features for Software Developers

New Common Controls

Many accessibility aids have difficulty working with applications that implement nonstandard controls. Windows 95 introduces a whole new set of controls available for mainstream software developers, and these standardized implementations are designed to cooperate with accessibility aids.

Using Accessibility Features in Windows 95

To see how the accessibility features in Windows 95 make it easy to customize the appearance and behavior of the computer, try them out, using the following procedures.



To perform mouse actions from the keyboard

- Press the left ALT, the left SHIFT, and the NUM LOCK keys simultaneously. You'll be able to drag and drop, and click or double-click both the primary and secondary mouse buttons by using your keyboard's numeric keypad.

For more information, see [MouseKeys](#).



To perform an ALT+TAB action with a pencil

1. Press a SHIFT key five consecutive times to start StickyKeys. When StickyKeys is activated, press the ALT key and see what happens. Press TAB and you'll have just typed two keys at once with a single finger.
2. Press the ALT key twice, then press TAB a few times to see the ALT + TAB window and cycle through all the tasks you have running. When you're satisfied, press ALT one more time to release it.
3. When you're ready to move on, turn off this feature by pressing two keys at the same time. Don't forget to watch the status indicator on the system taskbar.

This feature is helpful to users who type with only one finger or who use a mouthstick.



To get accessibility support for MS-DOS-based applications

- Start an MS-DOS-based application and try StickyKeys or MouseKeys. These features are available whenever you need them, regardless of what you may be doing, even when you're running MS-DOS-based applications.



To improve on-screen readability

- Press left ALT + left SHIFT + PRINT SCREEN and try to find a screen appearance that's better suited to your needs.

This feature is useful for individuals who can't read black text on a gray background because all the lines blur together.

Accessibility

Microsoft Services for People Who Are Deaf or Hard-of-Hearing

Through a text telephone (TT/TDD) service, Microsoft provides people who are deaf or hard-of-hearing with complete access to Microsoft product and customer services.

You can contact Microsoft Sales and Service on a text telephone by dialing (800) 892-5234 between 6:30 A.M. and 5:30 P.M. Pacific time. For technical assistance you can contact Microsoft Product Support Services on a text telephone at (206) 635-4948 between 6:00 A.M. and 6:00 P.M. Pacific time. Microsoft support services are subject to Microsoft prices, terms, and conditions in place at the time the service is used.

Accessibility

Keyboard Layouts for Single-Handed Users

Microsoft distributes Dvorak keyboard layouts that make the most frequently typed characters on a keyboard more accessible to people who have difficulty using the standard "QWERTY" layout. There are three Dvorak layouts: one for two-handed users, one for people who type with the left hand only, and one for people who type with the right hand only. The left-handed or right-handed keyboard layouts can also be used by people who type with a single finger or a wand. You do not need to purchase any special equipment in order to use these features.

Microsoft Windows already supports the two-handed Dvorak layout, which can be helpful in preventing or relieving some repetitive-motion injuries associated with typing. To get this layout, choose the International icon from Control Panel. The two layouts for people who type with one hand are distributed as Microsoft Application Note GA0650. It is also contained in file GA0650.ZIP on most network services or GA0650.EXE on the Microsoft Download Service. For instructions on using Microsoft Download Service to obtain this application note, see [Windows 95 Resource Directory](#).

Accessibility

Microsoft Documentation on Audio Cassettes and Floppy Disks

People who have difficulty reading or handling printed documentation can obtain most Microsoft publications from Recording for the Blind, Inc. Recording for the Blind distributes these documents to registered members of their distribution service either on audiocassettes or on floppy disks. The Recording for the Blind collection contains more than 80,000 titles, including Microsoft product documentation and books from Microsoft Press. You can contact Recording for the Blind at the following address or phone numbers:

Recording for the Blind, Inc.
20 Roszel Road
Princeton, NJ 08540

Phone: (800) 221-4792
Fax: (609) 987-8116
Phone outside U.S.: (609) 452-0606

Windows 95 documentation is available online in the CD-ROM version of Windows 95. This is also available from Recording for the Blind, Inc.

Accessibility-Enhancing Utilities from Other Vendors

A wide variety of hardware and software products designed to help people with disabilities use personal computers is currently available from other vendors. Among the different types of products available for the MS-DOS, Microsoft Windows, and Microsoft Windows NT operating systems are:

- Programs that enlarge or alter the color of information on the screen for people with visual impairments
- Programs that describe information on the screen in braille or in synthesized speech for people who are blind or have difficulty reading
- Hardware and software utilities that modify the behavior of the mouse and keyboard
- Programs that enable users to “type” using a mouse or their voice
- Word or phrase prediction software that allows one to type more quickly and with fewer keystrokes
- Alternate input devices, such as single switch or puff-and-sip devices, for those who cannot use a mouse or a keyboard

For more information on these types of products, see the following section.

Accessibility

Getting More Information on Accessibility

For more information on Microsoft products and services for people with disabilities, contact Microsoft Sales Information Center at the following address:

Microsoft Sales Information Center Voice telephone: (800) 426-9400
One Microsoft Way Text telephone: (800) 892-5234
Redmond, WA 98052-6393 Fax: (206) 635-6100

The Trace R&D Center at the University of Wisconsin–Madison produces a book and a compact disc that describe products that help people with disabilities use computers. The *Trace Resource Book* provides descriptions and photographs of about 2,000 products. The compact disc, titled *CO-NET CD*, provides a database of more than 18,000 products and other information for people with disabilities. It is issued twice a year.

You can contact the Trace R&D Center at the following address or telephone numbers:

Trace R&D Center Voice telephone: (608) 263-2309
S-151 Waisman Center Text telephone: (608) 263-5408
1500 Highland Avenue Fax: (608) 262-8848
Madison, WI 53705-2280

For general information and recommendations on how computers can help specific people, consult a trained evaluator who can best match your needs with the available solutions. An assistive technology program in your area will provide referrals to programs and services that are available to you. To locate the assistive technology program nearest you, contact:

National Information System Center Fax: (803) 777-6058
for Developmental Disabilities Voice/text phone
Benson Building in the U.S.: (803) 777-4434
University of South Carolina Voice/text phone
Columbia, SC 29208 outside the U.S.: (803) 777-6222

Introduction

This appendix provides information on obtaining additional support and information for Windows 95. This appendix also discusses the different Microsoft sources for support and assistance.

- [Online Information About Windows 95](#)
- [Getting Answers to Your Technical Questions](#)
- [Hardware Compatibility Information](#)
- [Windows 95 SDK Information](#)
- [Microsoft TechNet](#)
- [Microsoft Developer Network](#)
- [Microsoft Solution Providers](#)
- [Microsoft Technical Education](#)
- [Microsoft Consulting Services](#)
- [Microsoft Knowledge Base](#)
- [Microsoft Software Library](#)
- [Microsoft Download Service](#)
- [Microsoft CompuServe Forums](#)
- [Obtaining Drivers Electronically](#)
- [Resources for ICM](#)

Online Information About Windows 95

For Windows 95 information, see the WinNews areas on most major online services and networks.

Online service	WinNews access procedures
The Microsoft Network	From the Windows 95 desktop, click the Microsoft Network icon. Then click Microsoft and, in the Microsoft menu, select Windows 95. Click WinNews.
America Online®	Use the keyword winnews
CompuServe®	Type go winnews
FTP on the Internet	Type ftp://ftp.microsoft.com /PerOpSys/Win_News
GEnie™	Download files from the WinNews area under the Windows 95 RTC.
Prodigy™	Type jump winnews
World Wide Web on the Internet	Type http://www.microsoft.com

As an alternative to these online sources, the biweekly *WinNews Electronic Newsletter* is available. Subscribers receive this newsletter by mail, eliminating the need for regularly checking the WinNews areas for updates. To subscribe, type an Internet mail message addressed to **enews@microsoft.nwnet.com** with the words **subscribe winnews** as the only text in your message.

Getting Answers to Your Technical Questions

For answers to your questions and help with technical problems regarding Windows 95:

- First, check online Help (press the F1 key), the printed documentation set, and the information in the following files.

display.txt	network.txt
general.txt	printers.txt
internet.txt	readme.txt
mouse.txt	setup.txt
msn.txt	support.txt

- For fast answers to common questions and a library of technical notes delivered by recording or fax, call Microsoft FastTips for Windows 95 at (800) 936-4200, available seven days a week, 24 hours a day, including holidays. Microsoft FastTips is an automated system, accessible by touch-tone phone.
- Use The Microsoft Network or CompuServe to interact with other users and Microsoft Product Support Services (PSS) engineers, or to access the Microsoft Knowledge Base for product information. For CompuServe members, type **go winnews** to access the forum for Windows 95, or type **go mskb** to access the Microsoft Knowledge Base at any ! prompt.

For an introductory CompuServe membership kit, call (800) 848-8199 and ask for operator 463. For information about Microsoft forums on CompuServe, see [Microsoft CompuServe Forums](#); for information about Knowledge Base, see [Microsoft Knowledge Base](#).

- Use the Microsoft Download Service (MSDL) to access the latest technical notes on common support issues for Windows 95 and to access the Windows Driver Library by modem. The MSDL is available by modem at (206) 936-6735, seven days a week, 24 hours a day, including holidays. For more information, see [Microsoft Download Service](#) and [Obtaining Drivers Electronically](#).
- Contact a Microsoft Solution Provider for installation services and follow-up product support. These companies have individuals who have been qualified as Microsoft Certified Professionals on Windows 95. For a referral to a Microsoft Solution Provider in your area, please call Microsoft at (800) SOLPROV (or (800) 765-7768). For more information, see [Microsoft Solution Providers](#).
- Get technical support from a Microsoft engineer. Support is available for no charge from a Microsoft PSS engineer, by means of a toll line, for the first 90 days of using Windows 95. The 90-day period begins the day of your first call. Call (206) 637-7098 between 6:00 A.M. and 6:00 P.M. Pacific time, Monday through Friday, excluding national holidays. For support outside the United States, contact your local Microsoft subsidiary.

After the initial 90-day free period has expired, support is available from a Microsoft PSS engineer and charged by the length of time used or by the occurrence. Call (900) 555-2000 (\$2 per minute, \$25 cap) or (800) 936-5700 (\$25 per incident). For support outside the United States, contact your local Microsoft subsidiary.

Support for Microsoft TCP/IP for Windows 95 is not available from the standard Windows 95 PSS phone lines. To request TCP/IP support for Windows 95, please contact a Microsoft Solution Provider or enroll in one of the Microsoft fee-based support plans. For further information, call Microsoft Inside Sales at (800) 227-4679.

Microsoft Text Telephone (TT/TDD) services are available for people who are deaf or hard-of-hearing. Using a special TT/TDD modem, dial (206) 635-4948, between 6:00 A.M. and 6:00 P.M. Pacific time, Monday through Friday. For more information about the accessibility of Microsoft products and services to the deaf or hard-of-hearing, see [Accessibility](#).

Hardware Compatibility Information

Microsoft makes available a list of hardware which has been demonstrated to be compatible with Windows 95. For peripherals listed, manufacturers have submitted models for testing by Microsoft Compatibility Labs (MCL); for computers listed, manufacturers have submitted system compatibility testing results to MCL. The hardware compatibility list does not constitute a complete list of computers which currently run Windows 95.

For a current hardware compatibility list, see the WinNews area on CompuServe or The Microsoft Network.

Windows 95 Resource Directory

Windows 95 SDK Information

Developers who are writing applications to run under Windows 95 should obtain the *Win32 Software Development Kit for Windows 95 and Windows NT* (SDK). The SDK is available with a Level-2 subscription to the Microsoft Developer Network. For more information, see [Microsoft Developer Network](#).

Windows 95 Resource Directory

Microsoft TechNet

Microsoft TechNet is the comprehensive worldwide information service designed for those who support or educate users, administer networks or databases, create automated solutions, and recommend or evaluate information-technology solutions. For an annual TechNet subscription fee, subscribers receive two compact discs (CDs) per month containing Microsoft Knowledge Base, Resource Kits, up-to-date drivers, and other information. TechNet also maintains a CompuServe forum (**go technet**) for up-to-the-minute news. To subscribe in the United States and Canada, using your credit card, call (800) 344-2121, weekdays, between 6:30 A.M. and 5:30 P.M. Pacific time. For international orders, call (303) 684-0914 (in the United States) for contacts in your area.

Microsoft Developer Network

Microsoft Developer Network is an annual, two-tiered membership program for developers of applications for the family of Microsoft Windows operating systems. Level-1 members receive four quarterly updates to the Development Library, a source of sample applications and development tools and utilities; six bimonthly issues of the *Developer Network News*; a dedicated CompuServe forum (**go msdn**); and other benefits. Level-2 membership adds four quarterly updates to the Development Platform, offering the latest released versions of Microsoft software and device development kits and operating systems, plus support.

To join the Developer Network in the United States and Canada, call (800) 759-5474, 6:30 A.M. to 5:30 P.M. For local contacts outside North America, call (303) 684-0914.

Microsoft Solution Providers

Microsoft Solution Providers are independent organizations that provide consulting, integration, development, training, technical support, or other services with Microsoft products. Microsoft equips Solution Providers with information, business development assistance, and tools that help create additional value with Microsoft-based software technology. To locate a Microsoft Solution Provider in your area, or for more information on the Microsoft Solution Provider program in the United States, call Microsoft at (800) SOLPROV (or (800) 765-7768). In Canada, call (800) 563-9048.

Microsoft Technical Education

Microsoft Authorized Technical Education Centers provide computer professionals with the knowledge required to expertly install and support Microsoft solutions and help prepare individuals for Microsoft Certified Professional exams. Under the Microsoft Certified Professional program, individuals can authoritatively establish that they possess the skills and knowledge to implement and support solutions with Microsoft products.

For more information on the Microsoft Certified Professional program, call Microsoft at (800) 636-7544 in the United States and Canada. For full course descriptions and referral to a Microsoft Authorized Technical Education Center, call (800) SOLPROV (or (800) 765-7768) in the United States and Canada. In other countries, contact the local Microsoft subsidiary.

For the Microsoft Education and Certification Roadmap, see E&CMAP.ZIP from Library 5 of the Solution Provider forum on CompuServe (**go msedcert**).

Microsoft Consulting Services

Microsoft Consulting Services (MCS) provides services that enable corporations, governments, and other institutions worldwide to design and build client-server applications using Microsoft technology. MCS consultants are experienced in designing custom solutions for order entry, payroll, and a variety of other business functions. For more information, call (800) 426-9400 or the Microsoft Consulting Services office nearest you. For Microsoft Solutions Framework, a reference guide from MCS describing how to build and deploy distributed enterprise systems based on Microsoft tools and technologies, call (206) 703-4MSF (or (206) 703-4673) in the United States, or call the Microsoft Canada Customer Support Centre at (905) 712-0333, extension 7291.

Windows 95 Resource Directory

Microsoft Knowledge Base

Microsoft Knowledge Base (KB) is a primary source of product information for Microsoft support engineers and customers, containing detailed how-to articles, plus answers to technical support questions, bug lists, fix lists, and documentation corrections. Knowledge Base articles are available on CD with a membership in the Microsoft Developer Network or a subscription to Microsoft TechNet, and available online from CompuServe (**go mskb**, or **go mdkb** for the developer Knowledge Base), the Internet, and Microsoft Download Service.

Windows 95 Resource Directory

Microsoft Software Library

The Microsoft Software Library (MSL) is a collection of files pertaining to all Microsoft products, including drivers, utilities, Help files, and Application Notes. Microsoft Software Library files are available online from The Microsoft Network, CompuServe, the Internet, and Microsoft Download Service. You can also get the Microsoft Software Library on CD by becoming a member of the Microsoft Developer Network (MSDN) or by subscribing to Microsoft TechNet.

Microsoft Download Service

Microsoft Download Service (MSDL) operates in the same manner as any MS-DOS-based computer bulletin board system (BBS). MSDL contains Application Notes, driver files, and other types of support files you might want to download.

To use MSDL, you must have a modem and a terminal package such as Microsoft Works, Windows Terminal, Procomm, or Crosstalk™. If you experience difficulty while you are working with the MSDL, try calling a local BBS so you can avoid paying long-distance charges while trying to determine the cause of the problem. Technical support is not available on the MSDL.

MSDL supports 1200, 2400, 9600, and 14,400 baud rates (V.32 and V.42), with 8 data bits, 1 stop bit, and no parity. After you have chosen these settings, you can begin the session as follows.



To connect to Microsoft Download Service

1. Call MSDL at (206) 936-6735.
2. Type your full name and the location you are calling from.
3. At the MSDL Main Menu, type the number of the option you want.

From this menu you can download files, search the file index, view instructions on using MSDL, obtain a Windows driver library update, and obtain other information.

Windows 95 Resource Directory

Microsoft CompuServe Forums

In addition to forums offered for Microsoft TechNet and Microsoft Knowledge Base, Microsoft sponsors a variety of other forums on CompuServe; these forums are known collectively as the Microsoft Connection. Topics for some of these forums include information on Microsoft Corporation, Microsoft services, desktop and development applications, personal and advanced operating systems, shareware, and vendors. For access to the Microsoft Connection, type **go microsoft** at any CompuServe command prompt.

Obtaining Drivers Electronically

The Windows Driver Library (WDL) is a collection of new and updated printer, display, sound, and network drivers for use with Microsoft Windows. Network drivers on the WDL include NDIS 2 and NDIS 3 drivers for network adapters not included in the Windows 95 retail product. As new and updated files become available, they are added to the WDL.

If you have a modem, the drivers are available electronically for downloading at no charge on services such as Microsoft Download Service (using the File index option in the main menu), CompuServe (using **go msl**), and GENie (using Software Libraries in the IBM PC/Tandy roundtables menu). However, notice that standard connect-time fees and long-distance telephone charges, if any, apply when you download files. When you connect to any of these services, please read the WDL.TXT for a complete list of the devices the WDL supports.

If you do not have access to a modem, you can obtain an individual driver from the WDL on a disk by calling Microsoft Product Support Services at (206) 637-7098.

When searching for a WDL driver (or a WNTDL driver for Windows NT), you can use any of these keywords:

audio	misc	S#
display	netcard	storage
<i>manufacturer name</i>	printer	x86
mips	Q#	



To download a file from the Windows Driver Library

1. Locate the device in the WDL.TXT file. Make note of the name of the file listed next to the device. You need to download this file from your download service.
2. If you are downloading to a floppy disk, you need to have a formatted blank disk. If you are downloading to your hard disk, create a new subdirectory in which you will place the files.

Important Do not download files directly into your Windows directory. Doing so could overwrite files essential to the proper operation of your system.

3. Follow the downloading procedure used by your downloading service. The file you download is the executable (.EXE) file that you identified in step 1. This file contains all the files you need to support your device.
Download the .EXE file to your floppy disk or to the new subdirectory you created on your hard disk.
4. Change to the floppy disk drive (or the subdirectory on your hard disk) that contains the .EXE file. At the MS-DOS prompt, type the filename and then press ENTER.

When the .EXE file finishes running, all the files you need to support your device, such as a .DRV (Windows Driver Library) file and the OEMSETUP.INF file, are set up. You also have a .TXT file that contains instructions for installing the device drivers (or other software) and a licensing agreement.

If you have problems extracting files, try downloading the files again.

Windows 95 Resource Directory

Resources for ICM

Eastman Kodak, the supplier of the default color-matching method for ICM in Windows 95, has a wide array of advanced color management technology and products including device profiles which can be used to optimize your system. To get more information, call (800) 752-6567. You can also write to Eastman Kodak, Color Management Group, 164 Lexington Road, Billerica, MA 01821.

